



Automation Control Equipment

Damping Technology

ACE: Your partner for industrial shock absorbers,
gas springs and vibration control

Main Catalog 2018
North America



Imperial
Dimensions

**Complete Product Range
Data Sheets & Catalogs
CAD Database
Free Calculation Programs
Distributors
Services
News
etc.**

www.acecontrols.com

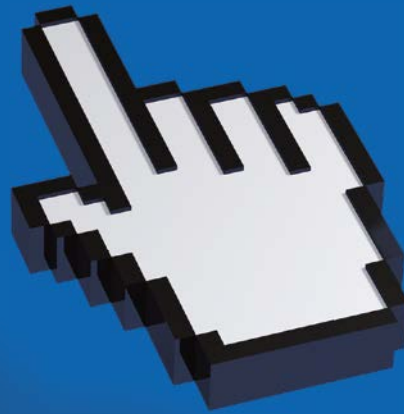

Dear customer,

You have made the right decision.

You will find over 280 pages of comprehensive information on the application fields of automation control (single direction of movement, i.e. deceleration), motion control (bidirectional movement, i.e. gas springs and dampers), vibration control and safety products. Each section is marked with a different color. This integrated concept is reflected in all documentation and on our www.acecontrols.com website. We also offer an ACE YouTube channel, extensive CAD library and calculation aids.

Innovations can as usual be found in the table of contents and on the individual catalogue pages.

ACE products assist you in making your production and processes faster, more efficient, quieter, easier, safer and more sustainable – underpinned by ACE product quality and our 5-star service.

Yours,
Jürgen Roland (Managing Director)



Free Application & Engineering Support

Tell us about your requirements and take advantage of our more than 50 years of expert knowledge in damping technology. Our specialists in engineering discuss your requirements with you and demonstrate our capabilities. Take advantage of our service hotline:

1-800-521-3320

Our regional managers are genuine product specialists. They will visit you onsite and work out customized solutions for you.

ACE service support and products are available in more than 40 countries worldwide.

Online Calculation Program & CAD Database

With our user-friendly calculation program, you can select the right product – online or via download. The CAD data is available in all standard formats in 2D and 3D.

www.acecontrols.com

Our specialist engineers create detailed technical solutions for you including assembly suggestions and details on machine loads, brake time and workload etc.

Automation Control

Motion Control

Vibration Control

Safety Products



Certified Quality

ACE products are exclusively manufactured from high quality and environmentally friendly materials. With constant quality monitoring and performance testing, we guarantee the highest quality products.

ACE pursues continual improvement throughout the production process in order to reduce material and energy consumption, the production of damaging substances and works to recycle or dispose of end products as gently as possible.

It is important to us to keep the strain on the environment as low as possible and simultaneously improve our services.

With ongoing optimization of our products, we strive to provide our customers with well designed products which are smaller, more effective and energy saving.



Miniature Shock Absorbers, Industrial Shock Absorbers, Heavy Industrial Shock Absorbers, Profile Dampers, Damping Pads



Industrial Gas Springs (push type), Industrial Gas Springs (pull type), Hydraulic Dampers, Hydraulic Feed Controls, Rotary Dampers



Rubber-Metal Isolators, Vibration-Isolating Pads, Low Frequency Pneumatic Leveling Mounts



Safety Shock Absorbers, Safety Dampers, Clamping Elements

We are your Specialists for Industrial Damping Technology

ACE is the world's globally recognized specialist in the field of industrial damping technology – with agencies in 45 countries on all continents. ACE was founded in Farmington Hills, Michigan in 1962.

ACE customers benefit from sophisticated solutions, valuable innovations and exemplary service around the topic of damping technology. Through close cooperation with leading engineering companies, ACE has established itself as a pioneer in the field of technical progress in damping technology.

This catalog is our attempt to provide a comprehensive service, including all the information you need to find solutions to your damping technology and vibration isolation challenges.

ACE develops, produces and sells a wide range of damping products. It comprises industrial and safety shock absorbers, profile dampers, rotary dampers, industrial gas springs, hydraulic dampers, vibration isolators, air springs and hydraulic feed controls.

Our advanced products are designed and engineered to help forward-thinking companies quickly, gently and precisely slow down moving masses or to isolate harmful vibrations.

ACE Product Variety

Concentrated knowledge on more than 280 pages



Page

6 Automation Control

| | |
|------------|--|
| 8 - 9 | Industrial shock absorbers – general information |
| 10 - 13 | Formulas and calculations |
| 14 - 15 | Industrial shock absorbers – capacity chart |
| 16 | Miniature Shock absorbers |
| | Product families |
| 18 - 39 | Accessories M5 to M25 – selection chart |
| 40 - 41 | Accessories 3/8-32 UNF to 1-12 UNF – selection chart |
| 42 - 43 | Accessories M5 to M25 – overview |
| 44 - 47 | Accessories 3/8-32 UNF to 1-12 UNF – overview |
| 48 - 49 | Accessories – technical information |
| 50 - 51 | Application examples |
| 52 - 53 | |
| 54 | Industrial Shock Absorbers |
| | Product families |
| 56 - 88 | Accessories M33 to M64 – overview |
| 90 - 92 | Accessories 1-1/4-12 UNF to 2-1/2-12 UNF – overview |
| 93 - 95 | Accessories – technical information |
| 96 | Application examples |
| 97 - 99 | |
| 100 | Heavy Industrial Shock Absorbers |
| | Product families |
| 102 - 109 | Special accessories – air/oil tanks |
| 110 - 111 | |
| 112 | Profile Dampers – TUBUS |
| | Profile dampers – capacity chart |
| 114 | |
| 116 | Product families |
| 127 - 128 | Application examples |
| 128 - 129 | |
| 130 | Special Profile Dampers – TUBUS |
| 132 | Damping Pads – SLAB |
| | Product families |
| 134 - 140 | Adhesive recommendation and technical information |
| 141 | Chemical resistance |
| 142 | Sample pads |
| 143 | Application examples |
| 144 - 145 | |

| | |
|------------|---|
| 146 | Motion Control |
| 148 | Gas Springs – Push Type |
| 150 - 171 | Product families |
| 169 | Additional stainless steel gas springs – capacity chart |
| 172 - 173 | Application examples |
| 174 | Gas Springs – Pull Type |
| 176 - 186 | Product families |
| 187 | Additional stainless steel gas springs – capacity chart |
| 188 - 189 | Gas spring calculation service and fax form |
| 190 | Mounting and safety instructions |
| 191 | Special accessories – valve actuation and refilling kit |
| 192 | Hydraulic Dampers |
| 194 - 208 | Product families |
| 210 - 211 | Application examples |
| 212 - 225 | Accessories for gas springs and hydraulic dampers |
| 226 | Hydraulic Feed Controls |
| 228 - 231 | Product families |
| 232 | Rotary Dampers |
| 236 - 249 | Product families |
| 250 | Calculations and accessories |
| 251 | Application examples |
| 252 | Vibration Control |
| 254 | Vibration isolation |
| 255 | Rubber-Metal Isolators |
| 256 | Vibration-Isolating Pads |
| 257 | Low Frequency Pneumatic Leveling Mounts |
| 258 | Safety Products |
| 260 | Safety Shock Absorbers |
| 262 - 273 | Product families |
| 274 | General instructions |
| 275 | Formulas and calculations |
| 276 - 277 | Application examples |
| 278 | Safety Dampers – TUBUS |
| 280 - 281 | Product families |
| 282 | Clamping Elements |
| 284 - 286 | Clamp versions |
| 288 - 289 | Application examples |

Automation Control

Miniature Shock Absorbers, Industrial Shock Absorbers
Heavy Industrial Shock Absorbers, Profile Dampers
Damping Pads



Optimum Customization

Tailor-made solutions for any application

ACE universal damping solutions convert kinetic energy in to heat. This makes machines faster, quieter, more durable, lighter and therefore more competitive and profitable.

Here you will find the perfect selection of machine elements, which turn damaging forces into harmless heat. These solutions from ACE smoothly decelerate moving loads. This involves the lowest possible stress on machines, which makes the damping products from ACE so valuable.



Industrial Shock Absorbers

Standard-setting damping solutions

The name says it all. ACE is considered the technology and market leader worldwide for small, medium-sized and heavy industrial shock absorbers is a result of the successful blend of quality, performance and the durability of the solutions.

ACE provides the right shock absorber for every industrial application. Over 200 different models are available, from the smallest model with a 0.16 inch stroke up to the biggest with 16 inches.

Whether self-compensating or adjustable, with ACE dampers between 6 in-lb/cycle and 1,120,000 in-lb/cycle can be absorbed and effective weights between 1.10 lbs and 225 tons can be decelerated with great precision.

In addition, ACE damping solutions impress with knowledgeable consulting, exemplary service and ideal matching accessories.

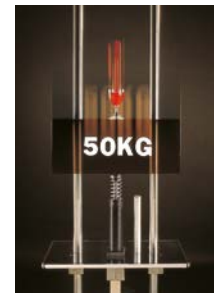

ACE demo showing a wine glass dropping free fall 0.05 inch. Decelerated by a shock absorber, not a drop of wine is spilled.

Stopping with Industrial Shock Absorbers

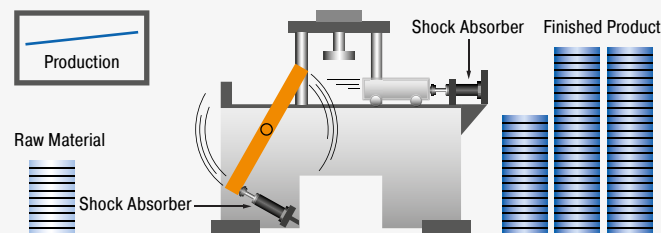

Advantages of using industrial shock absorbers

- Safe, reliable production
- Long service life of the machines
- Easy, inexpensive construction
- Low operating costs
- Quiet, economical machines
- Less stress on the machine
- Profit improvement

Stopping with Rubber Buffers, Springs, Dashpots or Cylinder Cushions

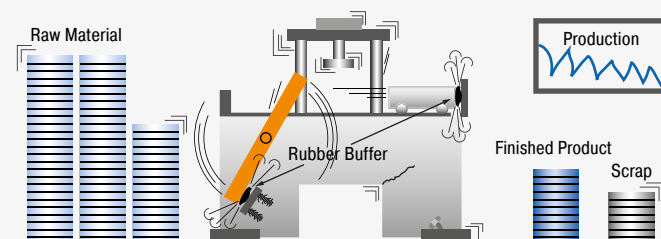

Results using conventional dampers

- Loss of production
- Machine damage
- Increased maintenance costs
- Increased operating noise
- Higher machine construction costs

Comparison of Different Damping Elements

When it comes to slowing down moving masses with constant damping force through the stroke, the industrial shock absorber is the right choice. A comparison demonstrates the differences of the damping elements.

ACE Industrial Shock Absorbers (Uniform stopping force through the entire stroke)

The moving load is smoothly and gently brought to rest by a constant resisting force throughout the entire shock absorber stroke. The load is decelerated with the lowest possible force in the shortest possible time eliminating damaging force peaks and shock damage to machines and equipment. This is a linear deceleration force stroke curve and is the curve provided by ACE industrial shock absorbers. In addition they considerably reduce noise pollution.

Hydraulic Dashpot (High stopping force at start of the stroke)

With only one metering orifice the moving load is abruptly slowed down at the start of the stroke. The braking force rises to a very high peak at the start of the stroke (giving high shock loads) and then falls away rapidly.

Springs and Rubber Buffers (High stopping forces at end of stroke)

At full compression. Also they store energy rather than dissipating it, causing the load to rebound back again.

Air Buffers, Pneumatic Cylinder Cushions (High stopping force at end of stroke)

Due to the compressibility of air these have a sharply rising force characteristic towards the end of the stroke. The majority of the energy is absorbed near the end of the stroke.

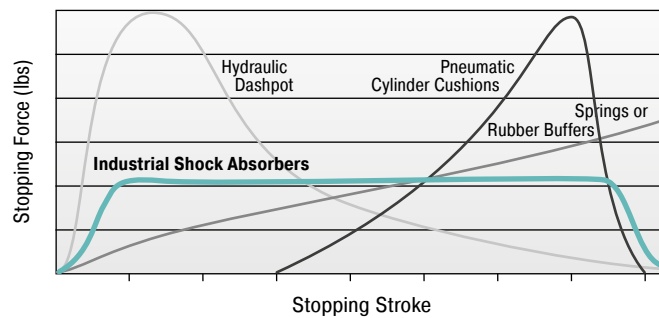

Comparison

The comparison shows the differences of the damping in a direct comparison of stopping force to stopping stroke.

Function of the Pressure Chamber

If a moving mass hits the industrial shock absorber, the piston puts the oil in the pressure chamber into motion. The oil is pressed through the metering orifices, which converts the discharged energy into heat. The metering orifices are arranged on the stroke so that the mass is dulled with a constant damping force. The hydraulic pressure is maintained throughout the entire braking process nearly constant.

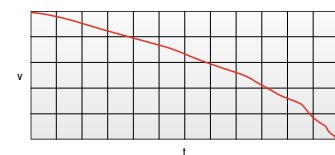
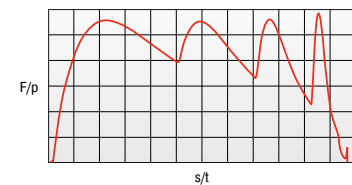
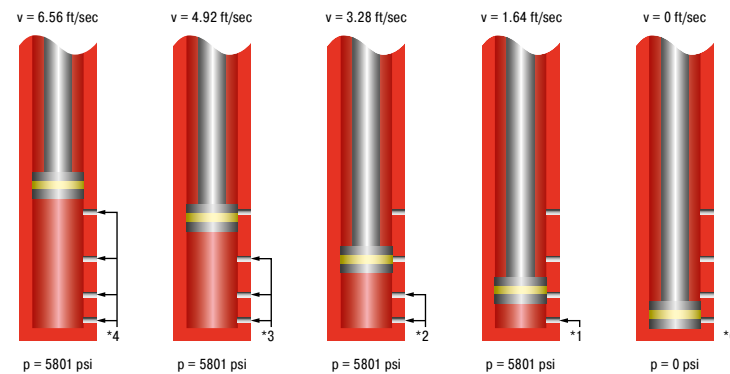

* The load velocity reduces continuously as you travel through the stroke due to the reduction in the number of metering orifices (*) in action. The internal pressure remains essentially constant and thus the force vs. stroke curve remains linear.

F = force (lbs), p = internal pressure (psi)
s = stroke (in), t = deceleration time (s),
v = velocity (ft/s)

Calculation Data for the Design of Industrial Shock Absorbers

ACE shock absorbers provide linear deceleration and are therefore superior to other kinds of damping elements. It is easy to calculate around 90 % of applications knowing only the following five parameters:

- | | | |
|---|----------------------|---------------|
| 1. Weight to be decelerated (weight) | W | [lbs] |
| 2. Impact velocity at shock absorber | v_D | [ft/s] |
| 3. Propelling force | F | [lbs] |
| 4. Cycles per hour | c | [/hr] |
| 5. Number of absorbers in parallel | n | |

Key to symbols used

| | | | | | |
|-----------------------------|---|-----------|-----------------|---|----------------------|
| E ₁ | Kinetic energy per cycle | in-lbs | ³ ST | Tall torque factor (normally 2.5) | 1 to 3 |
| E ₂ | Propelling force energy per cycle | in-lbs | T | Propelling torque | in-lbs |
| E ₃ | Total energy per cycle (E ₁ + E ₂) | in-lbs | I | Moment of Inertia | lb-ft-s ² |
| ¹ E ₄ | Total energy per hour (E ₃ · c) | in-lbs/hr | g | Acceleration due to gravity = 9.81 | ft/s ² |
| We | Effective weight | lbs | H | Drop height excl. shock absorber stroke | in |
| W | Weight to be decelerated | lbs | s | Shock absorber stroke | in |
| n | Number of shock absorbers (in parallel) | | L/R/r | Radius | in |
| ² v | Velocity at impact | ft/s | Q | Reaction force | lbs |
| ² v _D | Impact velocity at shock absorber | ft/s | μ | Coefficient of friction | |
| ω | Angular velocity at impact | rad/s | t | Deceleration time | s |
| F | Propelling force | lbs | a | Deceleration | ft/s ² |
| c | Cycles per hour | 1/hr | α | Side load angle | ° |
| P | Motor power | hp | β | Angle of incline | ° |

¹ All mentioned values of E₄ in the capacity charts are only valid for room temperature. There are reduced values at higher temperature ranges.

² v or v_D is the final impact velocity of the mass. With accelerating motion the final impact velocity can be 1.5 to 2 times higher than the average. Please take this into account when calculating kinetic energy.

³ ST ≙ relation between starting torque and running torque of the motor (depending on the design)

In all the following examples the choice of shock absorbers made from the capacity chart is based upon the values of (E₃), (E₄), (We) and the desired shock absorber stroke (s).

Note:

When using several shock absorbers in parallel, the values (E₃), (E₄) and (We) are divided according to the number of units used.

$$\text{Reaction force } Q \text{ [lbs]} \quad Q = \frac{1.5 \cdot E_3}{s}$$

$$\text{Stopping time } t \text{ [s]} \quad t = \frac{2.6 \cdot s}{v_D}$$

$$\text{Deceleration rate } a \text{ [ft/s}^2\text{]} \quad a = \frac{9 \cdot v_D^2}{s}$$

Approximate values assuming correct adjustment. Add safety margin if necessary.
(Exact values will depend upon actual application data and can be provided on request.)

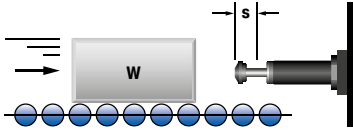
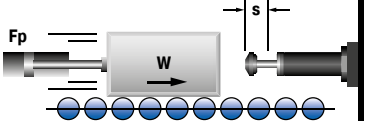
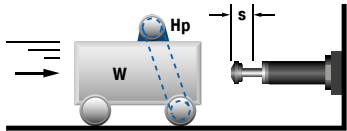
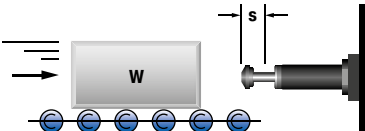
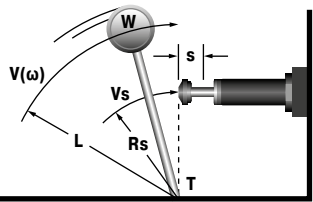
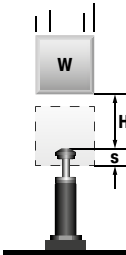
| Application | Formula | Example |
|---|--|--|
| 1 Weight without propelling force  | $E_1 = 0.186 \cdot W \cdot v^2$ $E_2 = F \cdot s$ $E_3 = E_1 + E_2$ $E_4 = E_3 \cdot c$ $We = \frac{E_3}{0.186 \cdot v^2}$ | $W = 500$ lbs $v = 3$ ft/s $F_p = 0$ lbs $s = 1$ in (chosen) $c = 500$ /hr $E_1 = 0.186 \cdot 500 \cdot 3^2 = 837$ in-lb $E_2 = 0 \cdot 1 = 0$ in-lb $E_3 = 837 + 0 = 837$ in-lb $E_4 = 837 \cdot 500 = 418500$ in-lb/hr $We = \frac{837}{0.186 \cdot 3^2} = 500$ lbs |
| | | Chosen from capacity chart: Model MC3325-3 self-compensating or MA3325 adjustable |
| 2 Weight with propelling force  | $E_1 = 0.186 \cdot W \cdot v^2$ $E_2 = F \cdot s$ $E_3 = E_1 + E_2$ $E_4 = E_3 \cdot c$ $We = \frac{E_3}{0.186 \cdot v^2}$ | $W = 14$ lb $v = 2.2$ ft/s $F = 30$ lbs $s = 0.4$ in (chosen) $c = 100$ /hr $E_1 = 0.186 \cdot 14 \cdot 2.2^2 = 12.6$ in-lb $E_2 = 30 \cdot 0.4 = 12$ in-lb $E_3 = 12.6 + 12 = 24.6$ in-lb $E_4 = 24.6 \cdot 100 = 2460$ in-lb/hr $We = \frac{24.6}{0.186 \cdot 2.2^2} = 27.3$ lbs |
| 2.1 for vertical motion upwards 2.2 for vertical motion downwards | $E_2 = (F - W) \cdot s$ $E_2 = (F + W) \cdot s$ | Chosen from capacity chart: Model MC75-3 self-compensating <small>¹ v is the final impact velocity of the mass: With pneumatically propelled systems this can be 1.5 to 2 times the average velocity. Please take this into account when calculating energy.</small> |
| 3 Weight with motor drive  | $F = \frac{ST \cdot Hp}{v}$ $E_1 = 55 \cdot W \cdot v^2$ $E_2 = F \cdot s$ $E_3 = E_1 + E_2$ $E_4 = E_3 \cdot c$ $We = \frac{E_3}{0.186 \cdot v^2}$ | $W = 2100$ lbs $v = 1$ ft/s $Hp = 2$ hp $ST = 2.5$ $s = 2$ in (chosen) $c = 20$ /hr $F = \frac{550 \cdot 2.5 \cdot 2}{1} = 2750$ lbs $E_1 = 0.186 \cdot 2100 \cdot 1^2 = 390.6$ in-lb $E_2 = 2750 \cdot 2 = 5500$ in-lb $E_3 = 390.6 + 5500 = 5890.6$ in-lb $E_4 = 5890.6 \cdot 20 = 117812$ lbs $We = \frac{5890.6}{0.186 \cdot 1^2} = 31670$ lbs |
| | | Chosen from capacity chart: Model ML6450 or MC6450-4 self-compensating Note: Do not forget to include the rotational energy of motor, coupling and gearbox into calculation for E ₁ . |
| 4 Weight on driven rollers  | $F = W \cdot \mu$ $E_1 = 0.186 \cdot W \cdot v^2$ $E_2 = F \cdot s$ $E_3 = E_1 + E_2$ $E_4 = E_3 \cdot c$ $We = \frac{E_3}{0.186 \cdot v^2}$ | $W = 250$ lbs $v = 2.5$ ft/s $\mu = 0.2$ in $s = 1$ in (chosen) $c = 180$ /hr $F = 250 \cdot 0.2 = 50$ lbs $E_1 = 0.186 \cdot 250 \cdot 2.5^2 = 290.6$ in-lb $E_2 = 50 \cdot 1 = 50$ in-lb $E_3 = 290.6 + 50 = 340.6$ in-lb $E_4 = 340.6 \cdot 180 = 61308$ in-lb/hr $We = \frac{340.6}{0.186 \cdot 2.5^2} = 293$ lbs |
| | | Chosen from capacity chart: Model MA600 adjustable or SC650-3 self-compensating |
| 5 Swinging weight with propelling force  | $E_1 = 0.186 \cdot W \cdot v^2$ $= 0.186 \cdot l \cdot \omega^2$ $E_2 = \frac{T \cdot s}{R}$ $E_3 = E_1 + E_2$ $E_4 = E_3 \cdot c$ $v_D = \frac{v \cdot R}{L} = \omega \cdot R$ $We = \frac{E_3}{0.186 \cdot v_D^2}$ | $W = 20$ lbs $v = 12$ ft/s $T = 50$ in-lb $R = 12$ in $L = 16$ in $s = 0.5$ in (chosen) $c = 700$ /hr $E_1 = 0.186 \cdot 20 \cdot 12^2 = 536$ in-lb $E_2 = \frac{50 \cdot 0.50}{12} = 2.1$ in-lb $E_3 = 536 + 2.1 = 538.1$ in-lb $E_4 = 538.1 \cdot 700 = 376670$ in-lb/hr $v_D = \frac{12 \cdot 12}{16} = 9$ ft/s $We = \frac{538.1}{0.186 \cdot 9^2} = 35.7$ lbs |
| | | Chosen from capacity chart: Model MC600 self-compensating Check the side load angle, $\tan \alpha = s/R$, with regard to "Max. Side Load Angle" in the capacity chart (see example 6.2) |
| 6 Free falling weight  | $v_D = \sqrt{5.4 \cdot D}$ $E_1 = 0.186 \cdot W \cdot v^2$ $E_2 = F \cdot s$ $E_3 = E_1 + E_2$ $E_4 = E_3 \cdot c$ $We = \frac{E_3}{0.186 \cdot v^2}$ $F = W$ | $W = 200$ lbs $D = 15$ in $s = 3$ in (chosen) $c = 60$ /hr $v = \sqrt{5.4 \cdot 15} = 9$ ft/s $E_1 = 0.186 \cdot 200 \cdot 9^2 = 3013.2$ in-lb $E_2 = 200 \cdot 3 = 600$ in-lb $E_3 = 3013.2 + 600 = 3613.2$ in-lb $E_4 = 3613.2 \cdot 60 = 216792$ in-lb/hr $We = \frac{3613.2}{0.186 \cdot 9^2} = 239.8$ lbs |
| | | Chosen from capacity chart: Model MA4575 adjustable |

| Application | Formula | Example |
|--|--|--|
| 6.1 Weight rolling/sliding down incline <p>6.1a propelling force up incline → 6.1b propelling force down incline →</p> | $E_1 = 0.186 \cdot W \cdot (\sqrt{5.4 \cdot H})^2$ $= 0.186 \cdot W \cdot v_D^2$ $E_2 = (W \cdot \sin(B)) \cdot s$ $E_3 = E_1 + E_2$ $E_4 = E_3 \cdot c$ $v_D = \sqrt{5.4 \cdot D}$ $We = \frac{E_3}{0.186 \cdot v_D^2}$ | <p>W = 1100 lbs H = 4 in c = 200 /hr B = 10 °</p> <p>$E_1 = 0.186 \cdot 1100 \cdot (\sqrt{5.4 \cdot 4})^2 = 4418.4$ in-lb $E_2 = (1100 \cdot \sin(10)) \cdot 2.91 = 555.8$ in-lb $E_3 = 4418.4 + 555.8 = 4975.2$ in-lb $E_4 = 4975.2 \cdot 200 = 995040$ in-lb/hr</p> <p>Chosen from capacity chart: Model MC4575-2 self-compensating</p> |
| 6.2 Weight free falling about a pivot point <p>$\tan \alpha = \frac{s}{R}$</p> | $E_1 = 0.186 \cdot W \cdot (\sqrt{5.4 \cdot H})^2$ $= 0.186 \cdot W \cdot v_D^2$ $E_2 = 0$ $E_3 = E_1 + E_2$ $E_4 = E_3 \cdot c$ $v_D = (\sqrt{5.4 \cdot H}) \cdot R \cdot L$ $We = \frac{E_3}{0.186 \cdot v_D^2}$ | <p>W = 120 lbs H = 40 in c = 50 /hr R = 12 in L = 20 in</p> <p>$E_1 = 0.186 \cdot 120 \cdot (\sqrt{5.4 \cdot 40})^2 = 4821.1$ in-lb $E_2 = 0 = 0$ in-lb $E_3 = 4821.1 + 0 = 4821.1$ in-lb $E_4 = 4821.1 \cdot 50 = 241055$ in-lb/hr</p> <p>Chosen from capacity chart: Model MC4550-1 self-compensating Check the side load angle, $\tan \alpha = s/R$, with regard to "Max. Side Load Angle" in the capacity chart</p> |
| 7 Rotary index table with propelling torque | $E_1 = 0.186 \cdot W_3 \cdot v_s^2$ $E_2 = F \cdot s$ $E_3 = E_1 + E_2$ $E_4 = E_3 \cdot c$ $v_D = \frac{v_s \cdot R}{L} = \omega \cdot R$ $We = \frac{E_3}{0.186 \cdot v^2}$ $W_a = \frac{W \cdot L^2}{2 \cdot R^2}$ $V = R \cdot \omega$ $F = T/R$ | <p>W = 195 lbs L = 20 in $v_s = 1.85$ ft/s T = 1700 in-lb R = 15 in c = 60 /hr s = 0.75 in (chosen)</p> <p>$W_a = \frac{195 \cdot 20^2}{2 \cdot 15^2} = 173.3$ lbs F = $\frac{1700}{15} = 113.3$ lbs $E_1 = 0.186 \cdot 173.3 \cdot 1.85^2 = 110.3$ in-lb $E_2 = 113.3 \cdot 0.75 = 85$ in-lb $E_3 = 110.3 + 85 = 195.3$ in-lb $E_4 = 195.3 \cdot 60 = 11718$ in-lb/hr $We = \frac{195.3}{0.186 \cdot 1.85^2} = 306.8$ lbs</p> <p>Chosen from capacity chart: Model SC300-4 or MC225H self-compensating Check the side load angle, $\tan \alpha = s/R_s$, with regard to "Max. Side Load Angle" in the capacity chart (see example 6.2)</p> |
| 8 Swinging arm with propelling torque (uniform weight distribution) | $E_1 = 0.063 \cdot W \cdot v^2$ $= 6 \cdot I \cdot (\omega^2 \cdot 0.01745)^2$ $E_2 = \frac{T \cdot s}{R}$ $E_3 = E_1 + E_2$ $E_4 = E_3 \cdot c$ $v_D = \frac{v \cdot R}{L} = \frac{\omega \cdot R}{688}$ $We = \frac{E_3}{0.186 \cdot v_D^2}$ | <p>I = 3.895 lb-ft-sec² $\omega = 70$ */s T = 15000 in-lb s = 1 in (chosen) L = 19 in R = 12 in c = 500 /hr</p> <p>$E_1 = 6 \cdot 3.895 (70 \cdot 0.01745)^2 = 34.86$ in-lb $E_2 = 15000 \cdot 1/12 = 1250$ in-lb $E_3 = 34.86 + 1250 = 1284.86$ in-lb $E_4 = 1284.86 \cdot 500 = 642430$ in-lb/hr $v_D = \frac{12 \cdot 70}{688} = 1.22$ ft/s $We = \frac{1284.86}{0.186 \cdot 1.22^2} = 4641.1$ lb</p> <p>Chosen from capacity chart: Model MC4525-4 self-compensating or MA4525 adjustable *Check the side load angle, $\tan \alpha = s/R$, with regard to "Max. Side Load Angle" in the capacity chart (see example 6.2)</p> |
| 9 Swinging arm with propelling force (uniform weight distribution) | $E_1 = 0.063 \cdot W \cdot v^2$ $= 6 \cdot I \cdot (\omega \cdot 0.01745)^2$ $E_2 = \frac{F \cdot r \cdot s}{R_s} = \frac{T \cdot s}{R_s}$ $E_3 = E_1 + E_2$ $E_4 = E_3 \cdot c$ $v_D = \frac{v \cdot R_s}{L} = \frac{\omega}{688}$ $We = \frac{E_3}{0.186 \cdot v_D^2}$ $T = F \cdot R_1$ | <p>W = 500 lbs v = 2 m/s F = 7000 N T = 4200 Nm s = 0.050 m (chosen) r = 0.6 m R = 0.8 m L = 1.2 m c = 900 /hr</p> <p>$E_1 = 0.063 \cdot 500 \cdot 6^2 = 1134$ in-lb T = $1600 \cdot 32 = 51200$ in-lb $E_2 = \frac{51200 \cdot 1.91}{24} = 4075$ in-lb $E_3 = 1134 + 4075 = 5209$ in-lb $E_4 = 5209 \cdot 90 = 468810$ in-lb/hr $v_D = \frac{6 \cdot 24}{48} = 3$ ft/s $We = \frac{5209}{0.186 \cdot 3^2} = 3112$ lbs</p> <p>Chosen from capacity chart: Model MC4550-4 self-compensating</p> |
| 10 Weight lowered at controlled speed | $E_1 = 0.186 \cdot W \cdot v^2$ $E_2 = F \cdot s$ $E_3 = E_1 + E_2$ $E_4 = E_3 \cdot c$ $v_D = v$ $We = \frac{E_3}{0.186 \cdot v_D^2}$ $F = W$ | <p>W = 1000 lbs v = 3 ft/s s = 0.91 in (chosen) c = 90 /hr</p> <p>$E_1 = 0.186 \cdot 1000 \cdot 3^2 = 1674$ in-lb F = 1000 lbs $E_2 = 1000 \cdot 0.91 = 910$ in-lbs $E_3 = 1674 + 910 = 2584$ in-lbs $E_4 = 2584 \cdot 60 = 155040$ in-lb/hr $We = \frac{2584}{0.186 \cdot 3^2} = 1543$ lbs</p> <p>Chosen from capacity chart: Model MC4525-3 self-compensating</p> |

Issue 04.2018 – Specifications subject to change

Effective Weight (We)

The effective weight (**We**) can either be the same as the actual weight (examples **A** and **C**), or it can be an imaginary weight representing a combination of the propelling force or lever action plus the actual weight (examples **B** and **D**).

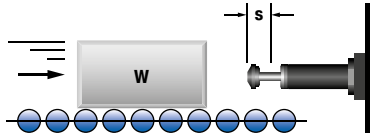
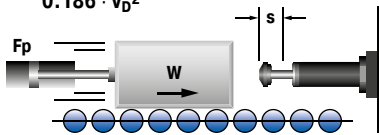
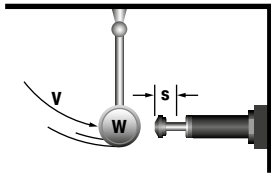
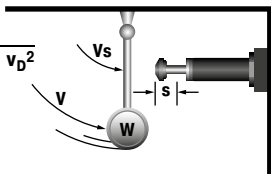
| Application | Example |
|---|---|
| <p>A Weight without propelling force</p> <p>Formula $We = W$</p>  | <p>W = 100 lbs $v_D = v = 2 \text{ ft/s}$ $E_1 = 0.186 \cdot W \cdot v^2 =$ $0.186 \cdot 100 \cdot 2^2 =$ 74.4 in-lbs $E_1 = 74.4 \text{ in-lbs}$ $We = E_3 / (0.186 \cdot v_D^2) =$ $74.4 / (0.186 \cdot 2^2) = \mathbf{100 \text{ lbs}}$</p> |
| <p>B Weight with propelling force</p> <p>Formula $We = \frac{E_3}{0.186 \cdot v_D^2}$</p>  | <p>W = 100 lbs $F = 200 \text{ lbs}$ $v_D = v = 2 \text{ ft/s}$ $s = 2 \text{ in (chosen)}$ $E_1 = 0.186 \cdot W \cdot v^2 =$ $0.186 \cdot 100 \cdot 2^2 = 74.4 \text{ in-lbs}$ $E_2 = F \cdot s = 200 \cdot 2 = 400 \text{ in-lbs}$ $E_3 = E_1 + E_2 = 74.4 + 400$ $= 474.4 \text{ in-lbs}$ $We = E_3 / (0.186 \cdot v_D^2) =$ $= 474.4 / (0.186 \cdot 2^2) = \mathbf{637.6 \text{ lbs}}$</p> |
| <p>C Weight without propelling force direct against shock absorber</p> <p>Formula $We = W$</p>  | <p>W = 50 lbs $v_D = v = 2 \text{ ft/s}$ $E_1 = 0.186 \cdot W \cdot v^2 =$ $0.186 \cdot 50 \cdot 2^2 = 37.2 \text{ in-lbs}$ $E_1 = E_3 = 37.2 \text{ in-lbs}$ $We = \frac{E_3}{0.186 \cdot v_D^2} =$ $\frac{37.2}{0.186 \cdot 2^2} = \mathbf{50 \text{ lbs}}$</p> |
| <p>D Weight without propelling force with mechanical advantage</p> <p>Formula $We = \frac{E_3}{0.186 \cdot v_D^2}$</p>  | <p>W = 150 lbs $v = 2 \text{ ft/s}$ $v_s = v_D = 0.5 \text{ ft/s}$ $E_1 = 0.186 \cdot W \cdot v^2 =$ $0.186 \cdot 150 \cdot 2^2 = 111.6 \text{ in-lbs}$ $E_1 = E_3 = 111.6 \text{ in-lbs}$ $We = \frac{E_3}{0.186 \cdot v_D^2} =$ $\frac{111.6}{0.186 \cdot 0.5^2} = \mathbf{2400 \text{ lbs}}$</p> |



Self-Compensating Shock Absorbers

| TYPES | Stroke inch | Energy capacity in-lbs/cycle | Effective Weight | | Page |
|-------------|----------------|---------------------------------|------------------|----------------|------|
| | | | We min. lbs | We max. lbs | |
| MC5M-1-B | 0.16 | 6 | 0.22 | 2.0 | 19 |
| MC5M-2-B | 0.16 | 6 | 1.7 | 4.9 | 19 |
| MC5M-3-B | 0.16 | 6 | 4.4 | 11.1 | 19 |
| MC9M-2-B | 0.20 | 9 | 1.75 | 9.0 | 19 |
| MC9M-1-B | 0.20 | 9 | 1.35 | 7.0 | 19 |
| MC25 | 0.26 | 20 | 4 | 12 | 19 |
| MC25H | 0.26 | 20 | 10 | 30 | 19 |
| MC25L | 0.26 | 20 | 1.5 | 5.0 | 19 |
| MC30M-1 | 0.32 | 31 | 1.0 | 4.3 | 19 |
| MC30M-2 | 0.32 | 31 | 3.97 | 11.9 | 19 |
| MC30M-3 | 0.32 | 31 | 11.02 | 33.0 | 19 |
| MC75-1 | 0.40 | 75 | 0.5 | 2.5 | 19 |
| MC75-2 | 0.40 | 75 | 2 | 14 | 19 |
| MC75-3 | 0.40 | 75 | 6 | 80 | 19 |
| MC75-4 | 0.40 | 75 | 55 | 160 | 19 |
| MC150 | 0.5 | 175 | 2 | 22 | 21 |
| MC150H | 0.5 | 175 | 20 | 200 | 21 |
| MC150H2 | 0.5 | 175 | 150 | 450 | 21 |
| MC150H3 | 0.5 | 175 | 400 | 900 | 21 |
| MC225 | 0.5 | 360 | 5 | 55 | 21 |
| MC225H | 0.50 | 360 | 50 | 500 | 21 |
| MC225H2 | 0.50 | 360 | 400 | 2,000 | 21 |
| MC225H3 | 0.50 | 360 | 1,800 | 4,000 | 21 |
| MC600 | 1.00 | 1,200 | 20 | 300 | 21 |
| MC600H | 1.00 | 1,200 | 250 | 2,500 | 21 |
| MC600H2 | 1.00 | 1,200 | 880 | 5,000 | 21 |
| MC600H3 | 1.00 | 1,200 | 4,800 | 10,000 | 21 |
| SC25M-5 | 0.32 | 89 | 2.2 | 11 | 31 |
| SC25M-6 | 0.32 | 89 | 9 | 97 | 31 |
| SC25M-7 | 0.32 | 89 | 93 | 1,100 | 31 |
| SC75M-5 | 0.39 | 142 | 2.2 | 18 | 31 |
| SC75M-6 | 0.39 | 142 | 15 | 272 | 31 |
| SC75M-7 | 0.39 | 142 | 165 | 1,760 | 31 |
| SC190M-5 | 0.47 | 274 | 4.4 | 35.2 | 31 |
| SC190M-6 | 0.47 | 274 | 29 | 309 | 31 |
| SC190M-7 | 0.47 | 274 | 300 | 3,400 | 31 |
| SC300-5 | 0.59 | 650 | 25 | 100 | 33 |
| SC300-6 | 0.59 | 650 | 75 | 300 | 33 |
| SC300-7 | 0.59 | 650 | 200 | 400 | 33 |
| SC300-8 | 0.59 | 650 | 300 | 1,500 | 33 |
| SC300-9 | 0.59 | 650 | 700 | 4,300 | 33 |
| SC650-5 | 0.91 | 1,860 | 50 | 250 | 33 |
| SC650-6 | 0.91 | 1,860 | 200 | 800 | 33 |
| SC650-7 | 0.91 | 1,860 | 700 | 2,400 | 33 |
| SC650-8 | 0.91 | 1,860 | 1,700 | 5,800 | 33 |
| SC650-9 | 0.91 | 1,860 | 4,000 | 14,000 | 33 |
| SC25M-5-HC | 0.16 | 20 | 2.2 | 11.0 | 35 |
| SC25M-6-HC | 0.16 | 20 | 9 | 97 | 35 |
| SC25M-7-HC | 0.16 | 20 | 93 | 1,100 | 35 |
| SC75M-5-HC | 0.20 | 75 | 2.2 | 18 | 35 |
| SC75M-6-HC | 0.20 | 75 | 15 | 272 | 35 |
| SC75M-7-HC | 0.20 | 75 | 165 | 1,760 | 35 |
| SC190M-5-HC | 0.30 | 175 | 4.4 | 35.2 | 35 |
| SC190M-6-HC | 0.30 | 175 | 29 | 309 | 35 |
| SC190M-7-HC | 0.30 | 175 | 300 | 3,400 | 35 |
| SC300-5-HC | 0.33 | 650 | 25 | 100 | 35 |
| SC300-6-HC | 0.33 | 650 | 75 | 300 | 35 |
| SC300-7-HC | 0.33 | 650 | 200 | 400 | 35 |
| SC300-8-HC | 0.33 | 650 | 300 | 1,500 | 35 |
| SC300-9-HC | 0.33 | 650 | 700 | 4,300 | 35 |
| SC650-5-HC | 0.59 | 1,200 | 50 | 250 | 35 |
| SC650-6-HC | 0.59 | 1,200 | 200 | 800 | 35 |
| SC650-7-HC | 0.59 | 1,200 | 700 | 2,400 | 35 |
| SC650-8-HC | 0.59 | 1,200 | 1,700 | 5,800 | 35 |
| SC650-9-HC | 0.59 | 1,200 | 4,000 | 14,000 | 35 |
| MC3325-0 | 0.91 | 1,505 | 6.61 | 24.25 | 57 |
| MC3325-1 | 0.91 | 1,505 | 20 | 80 | 57 |
| MC3325-2 | 0.91 | 1,505 | 68 | 272 | 57 |
| MC3325-3 | 0.91 | 1,505 | 230 | 920 | 57 |
| MC3325-4 | 0.91 | 1,505 | 780 | 3,120 | 57 |
| MC3350-0 | 1.91 | 2,921 | 11.00 | 48.50 | 57 |
| MC3350-1 | 1.91 | 3,100 | 40 | 160 | 57 |

Self-Compensating Shock Absorbers

| TYPES | Stroke inch | Energy capacity in-lbs/cycle | Effective Weight | | Page |
|-----------|----------------|---------------------------------|------------------|----------------|------|
| | | | We min. lbs | We max. lbs | |
| MC3350-2 | 1.91 | 3,100 | 136 | 544 | 57 |
| MC3350-3 | 1.91 | 3,100 | 460 | 1,840 | 57 |
| MC3350-4 | 1.91 | 3,100 | 1,560 | 6,240 | 57 |
| MC4525-0 | 0.91 | 3,275 | 15.4 | 59.2 | 58 |
| MC4525-1 | 0.91 | 3,275 | 50 | 200 | 58 |
| MC4525-2 | 0.91 | 3,275 | 170 | 680 | 58 |
| MC4525-3 | 0.91 | 3,275 | 575 | 2,300 | 58 |
| MC4525-4 | 0.91 | 3,275 | 1,950 | 7,800 | 58 |
| MC4550-0 | 1.91 | 6,550 | 28.6 | 119.0 | 58 |
| MC4550-1 | 1.91 | 6,550 | 100 | 400 | 58 |
| MC4550-2 | 1.91 | 6,550 | 340 | 1,360 | 58 |
| MC4550-3 | 1.91 | 6,550 | 1,150 | 4,600 | 58 |
| MC4550-4 | 1.91 | 6,550 | 3,900 | 15,600 | 58 |
| MC4575-0 | 2.91 | 10,000 | 44.0 | 176.4 | 58 |
| MC4575-1 | 2.91 | 10,000 | 150 | 600 | 58 |
| MC4575-2 | 2.91 | 10,000 | 510 | 2,040 | 58 |
| MC4575-3 | 2.91 | 10,000 | 1,370 | 6,920 | 58 |
| MC4575-4 | 2.91 | 10,000 | 5,850 | 23,400 | 58 |
| MC6450-0 | 1.91 | 16,551 | 308 | 1,190 | 59 |
| MC6450-1 | 1.91 | 16,551 | 300 | 1,200 | 59 |
| MC6450-2 | 1.91 | 16,551 | 1,020 | 4,080 | 59 |
| MC6450-3 | 1.91 | 16,551 | 3,460 | 13,480 | 59 |
| MC6450-4 | 1.91 | 16,551 | 11,700 | 46,800 | 59 |
| MC64100-0 | 3.91 | 33,013 | 154 | 617 | 59 |
| MC64100-1 | 3.91 | 33,013 | 600 | 2,400 | 59 |
| MC64100-2 | 3.91 | 33,013 | 2,040 | 8,160 | 59 |
| MC64100-3 | 3.91 | 33,013 | 6,920 | 27,680 | 59 |
| MC64100-4 | 3.91 | 33,013 | 23,400 | 93,600 | 59 |
| MC64150-0 | 5.91 | 50,007 | 220 | 1,014 | 59 |
| MC64150-1 | 5.91 | 50,007 | 900 | 3,600 | 59 |
| MC64150-2 | 5.91 | 50,007 | 3,060 | 12,240 | 59 |
| MC64150-3 | 5.91 | 50,007 | 10,380 | 41,520 | 59 |
| MC64150-4 | 5.91 | 50,007 | 35,100 | 140,400 | 59 |
| SC3325-5 | 0.91 | 1,372 | 2,998 | 5,999 | 73 |
| SC3325-6 | 0.91 | 1,372 | 5,512 | 12,000 | 73 |
| SC3325-7 | 0.91 | 1,372 | 10,999 | 19,698 | 73 |
| SC3325-8 | 0.91 | 1,372 | 18,999 | 29,998 | 73 |
| SC3350-5 | 1.91 | 2,744 | 5,999 | 11,001 | 73 |
| SC3350-6 | 1.91 | 2,744 | 10,000 | 22,002 | 73 |
| SC4525-5 | 0.91 | 3,009 | 7,496 | 14,991 | 74 |
| SC4525-6 | 0.91 | 3,009 | 13,999 | 29,983 | 74 |
| SC4525-7 | 0.91 | 3,009 | 27,999 | 49,999 | 74 |
| SC4525-8 | 0.91 | 3,009 | 44,998 | 85,980 | 74 |
| SC4550-5 | 1.91 | 6,019 | 14,991 | 26,998 | 74 |
| SC4550-6 | 1.91 | 6,019 | 25,992 | 59,498 | 74 |
| SC4550-7 | 1.91 | 6,019 | 56,998 | 97,499 | 74 |
| CA2X2-1 | 2.00 | 32,000 | 1,600 | 4,800 | 103 |
| CA2X2-2 | 2.00 | 32,000 | 4,000 | 12,000 | 103 |
| CA2X2-3 | 2.00 | 32,000 | 10,000 | 30,000 | 103 |
| CA2X2-4 | 2.00 | 32,000 | 25,000 | 75,000 | 103 |
| CA2X4-1 | 4.00 | 64,000 | 3,200 | 9,600 | 103 |
| CA2X4-2 | 4.00 | 64,000 | 8,000 | 24,000 | 103 |
| CA2X4-3 | 4.00 | 64,000 | 20,000 | 80,000 | 103 |
| CA2X4-4 | 4.00 | 64,000 | 50,000 | 150,000 | 103 |
| CA2X6-1 | 6.00 | 96,000 | 4,800 | 14,400 | 103 |
| CA2X6-2 | 6.00 | 96,000 | 12,000 | 36,000 | 103 |
| CA2X6-3 | 6.00 | 96,000 | 30,000 | 90,000 | 103 |
| CA2X6-4 | 6.00 | 96,000 | 75,000 | 225,000 | 103 |
| CA2X8-1 | 8.00 | 128,000 | 6,400 | 19,200 | 103 |
| CA2X8-2 | 8.00 | 128,000 | 16,000 | 48,000 | 103 |
| CA2X8-3 | 8.00 | 128,000 | 40,000 | 120,000 | 103 |
| CA2X8-4 | 8.00 | 128,000 | 100,000 | 300,000 | 103 |
| CA2X10-1 | 10.00 | 160,000 | 8,000 | 24,000 | 103 |
| CA2X10-2 | 10.00 | 160,000 | 20,000 | 60,000 | 103 |
| CA2X10-3 | 10.00 | 160,000 | 50,000 | 150,000 | 103 |
| CA2X10-4 | 10.00 | 160,000 | 125,000 | 375,000 | 103 |
| CA3X5-1 | 5.00 | 125,000 | 6,400 | 19,200 | 104 |
| CA3X5-2 | 5.00 | 125,000 | 16,000 | 48,000 | 104 |
| CA3X5-3 | 5.00 | 125,000 | 40,000 | 120,000 | 104 |
| CA3X5-4 | 5.00 | 125,000 | 100,000 | 300,000 | 104 |
| CA3X8-1 | 8.00 | 200,000 | 10,240 | 30,720 | 104 |
| CA3X8-2 | 8.00 | 200,000 | 25,600 | 76,800 | 104 |

Self-Compensating Shock Absorbers

| TYPES | Stroke inch | Energy capacity in-lbs/cycle | Effective Weight | | Page |
|----------|----------------|---------------------------------|------------------|----------------|------|
| | | | We min. lbs | We max. lbs | |
| CA3X8-3 | 8.00 | 200,000 | 64,000 | 192,000 | 104 |
| CA3X8-4 | 8.00 | 200,000 | 160,000 | 480,000 | 104 |
| CA3X12-1 | 12.00 | 300,000 | 15,360 | 46,080 | 104 |
| CA3X12-2 | 12.00 | 300,000 | 38,400 | 15,200 | 104 |
| CA3X12-3 | 12.00 | 300,000 | 96,000 | 288,000 | 104 |
| CA3X12-4 | 12.00 | 300,000 | 240,000 | 720,000 | 104 |
| CA4X6-3 | 6.00 | 420,000 | 8,000 | 19,000 | 105 |
| CA4X6-5 | 6.00 | 420,000 | 19,000 | 41,000 | 105 |
| CA4X6-7 | 6.00 | 420,000 | 41,000 | 94,000 | 105 |
| CA4X8-3 | 8.00 | 560,000 | 11,000 | 25,000 | 105 |
| CA4X8-5 | 8.00 | 560,000 | 25,000 | 55,000 | 105 |
| CA4X8-7 | 8.00 | 560,000 | 55,000 | 125,000 | 105 |
| CA4X16-3 | 16.00 | 1,120,000 | 22,000 | 50,000 | 105 |
| CA4X16-5 | 16.00 | 1,120,000 | 50,000 | 110,000 | 105 |
| CA4X16-7 | 16.00 | 1,120,000 | 110,000 | 250,000 | 105 |

Adjustable Shock Absorbers

| TYPES | Stroke inch | Max. Energy Capacity | | Effective Weight | | Page |
|--------------|----------------|--------------------------------|----------------------------|------------------|----------------|------|
| | | E ₃ in-lbs/cycle | E ₄ in-lbs/h | We min. lbs | We max. lbs | |
| MA30M | 0.32 | 31 | 50,000 | 0.5 | 31 | 37 |
| MA50M | 0.28 | 50 | 120,000 | 10 | 45 | 37 |
| MA35 | 0.40 | 35 | 53,000 | 13 | 125 | 37 |
| MA150 | 0.50 | 200 | 300,000 | 2 | 240 | 37 |
| MA225 | 0.75 | 300 | 400,000 | 5 | 500 | 37 |
| MA600 | 1.00 | 600 | 600,000 | 20 | 3,000 | 37 |
| MA900 | 1.58 | 900 | 800,000 | 30 | 4,500 | 37 |
| AS3/8X1 | 1.00 | 600 | 600,000 | 10 | 1,250 | 39 |
| NA3/8x1 | 1.00 | 600 | 600,000 | 10 | 1,250 | 39 |
| MA3325 | 0.91 | 1,900 | 670,000 | 20 | 3,800 | 77 |
| ML3325 | 0.91 | 1,900 | 670,000 | 661 | 110,231 | 77 |
| MA3350 | 1.91 | 3,800 | 760,000 | 28 | 5,400 | 77 |
| ML3350 | 1.91 | 3,800 | 760,000 | 1,102 | 176,370 | 77 |
| MA4525 | 0.91 | 3,762 | 950,000 | 95 | 22,000 | 78 |
| ML4525 | 0.91 | 3,762 | 950,000 | 6,614 | 242,508 | 78 |
| MA4550 | 1.91 | 7,523 | 1,000,000 | 150 | 32,000 | 78 |
| ML4550 | 1.91 | 7,523 | 1,000,000 | 11,023 | 396,832 | 78 |
| MA4575 | 2.91 | 11,506 | 1,300,000 | 155 | 33,000 | 78 |
| ML6425 | 0.91 | 10,046 | 1,100,000 | 15,432 | 661,386 | 79 |
| MA6450 | 1.91 | 20,135 | 1,300,000 | 480 | 110,000 | 79 |
| ML6450 | 1.91 | 20,135 | 1,300,000 | 24,250 | 1,102,310 | 79 |
| MA64100 | 3.91 | 40,005 | 1,700,000 | 600 | 115,000 | 79 |
| MA64150 | 5.91 | 60,008 | 2,200,000 | 730 | 175,000 | 79 |
| SASL11/8X1-R | 0.91 | 8,000 | 1,250,000 | 700 | 700,000 | 81 |
| SASL11/8X2-R | 1.91 | 16,000 | 1,500,000 | 850 | 1,300,000 | 81 |
| SALD½X1-P | 0.91 | 1,350 | 750,000 | 10 | 2,700 | 83 |
| SALD½X2-P | 1.91 | 2,700 | 870,000 | 21 | 5,700 | 83 |
| SALD¾X1-P | 0.91 | 3,000 | 1,100,000 | 20 | 18,000 | 84 |
| SALD¾X2-P | 1.91 | 6,000 | 1,300,000 | 35 | 32,000 | 84 |
| SALD¾X3-P | 2.91 | 9,000 | 1,600,000 | 50 | 46,000 | 84 |
| SALD11/8X2-P | 1.91 | 16,000 | 1,500,000 | 120 | 50,000 | 85 |
| SALD11/8X4-P | 3.91 | 32,000 | 2,000,000 | 160 | 100,000 | 85 |
| SALD11/8X6-P | 5.91 | 48,000 | 2,500,000 | 200 | 150,000 | 85 |
| SALDN¾X1-RF | 0.98 | 3,450 | 950,000 | 95 | 22,000 | 87 |
| SALDN¾X2-RF | 1.97 | 6,900 | 1,000,000 | 150 | 32,000 | 87 |
| SALDN¾X3-RF | 2.95 | 10,350 | 1,300,000 | 155 | 33,000 | 87 |
| SALDN¾X1-RR | 0.98 | 3,450 | 950,000 | 95 | 22,000 | 88 |
| SALDN¾X2-RR | 1.97 | 6,900 | 1,000,000 | 150 | 32,000 | 88 |
| SALDN¾X3-RR | 2.95 | 10,350 | 1,300,000 | 155 | 33,000 | 88 |
| A1½X2 | 2.00 | 21,000 | 3,200,000 | 430 | 70,000 | 107 |
| A1½X3½ | 3.50 | 36,750 | 5,600,000 | 480 | 80,000 | 107 |
| A1½X5 | 5.00 | 52,500 | 8,000,000 | 500 | 90,000 | 107 |
| A1½X6½ | 6.50 | 68,250 | 10,400,000 | 680 | 100,000 | 107 |
| A2X2 | 2.00 | 32,000 | 9,600,000 | 560 | 170,000 | 108 |
| A2X4 | 4.00 | 80,000 | 12,000,000 | 560 | 180,000 | 108 |
| A2X6 | 6.00 | 120,000 | 14,400,000 | 570 | 190,000 | 108 |
| A2X8 | 8.00 | 170,000 | 16,800,000 | 580 | 200,000 | 108 |
| A2X10 | 10.00 | 210,000 | 19,200,000 | 720 | 250,000 | 108 |
| A3X5 | 5.00 | 140,000 | 20,000,000 | 1,050 | 340,000 | 109 |
| A3X8 | 8.00 | 250,000 | 32,000,000 | 1,200 | 400,000 | 109 |
| A3X12 | 12.00 | 390,000 | 48,000,000 | 1,350 | 450,000 | 109 |

Shock Absorbers Soft Contact and Self-Compensating

| TYPES | Stroke inch | Energy capacity in-lbs/cycle | Effective Weight | | | | Page |
|---------|----------------|---------------------------------|------------------|----------------|-------------------|----------------|------|
| | | | Soft-Contact | | Self-Compensating | | |
| | | | me min. lbs | me max. lbs | me min. lbs | me max. lbs | |
| SC190-0 | 0.63 | 225 | - | - | 1.54 | 8.82 | 29 |
| SC190-1 | 0.63 | 225 | 5 | 13 | 3 | 15 | 29 |
| SC190-2 | 0.63 | 225 | 12 | 36 | 8 | 40 | 29 |
| SC190-3 | 0.63 | 225 | 30 | 90 | 20 | 100 | 29 |
| SC190-4 | 0.63 | 225 | 75 | 200 | 50 | 225 | 29 |
| SC300-0 | 0.75 | 300 | - | - | 1.54 | 4 | 29 |
| SC300-1 | 0.75 | 300 | 5 | 15 | 3 | 18 | 29 |
| SC300-2 | 0.75 | 300 | 15 | 50 | 10 | 60 | 29 |
| SC300-3 | 0.75 | 300 | 50 | 150 | 30 | 180 | 29 |
| SC300-4 | 0.75 | 300 | 150 | 400 | 70 | 450 | 29 |
| SC650-0 | 1.00 | 650 | - | - | 5.07 | 30.86 | 29 |
| SC650-1 | 1.00 | 650 | 24 | 80 | 17 | 100 | 29 |
| SC650-2 | 1.00 | 650 | 75 | 250 | 50 | 300 | 29 |
| SC650-3 | 1.00 | 650 | 240 | 800 | 150 | 900 | 29 |
| SC650-4 | 1.00 | 650 | 800 | 2,400 | 450 | 2,600 | 29 |
| SC925-0 | 1.58 | 975 | 18 | 55 | 10 | 65 | 29 |
| SC925-1 | 1.58 | 975 | 50 | 160 | 30 | 200 | 29 |
| SC925-2 | 1.58 | 975 | 130 | 460 | 90 | 600 | 29 |
| SC925-3 | 1.58 | 975 | 400 | 1,350 | 250 | 1,600 | 29 |
| SC925-4 | 1.58 | 975 | 1,200 | 4,300 | 750 | 4,600 | 29 |

Miniature Shock Absorbers

Tuning for almost any design

Miniature shock absorbers from ACE are tried-and-tested quality products used in millions of industrial designs throughout the world. They optimize machines in an equally reliable and effective way by decelerating loads quickly and without recoil.

The compact, maintenance-free, hydraulic machine elements can be easily and quickly integrated in any design and certain models can be directly integrated in pneumatic cylinders. They reduce the load and increase the efficiency for handling devices, rotary and pivoting actuators, linear cylinders and many other industrial applications. ACE ensures a long service life with innovative sealing techniques, shock absorber and inner pressure chambers fully machined from solid high tensile alloy steel.

Easy, inexpensive construction

Large variety of models for every purpose

Less stress on the machine

Reduced operating costs

Maintenance-free



Miniature Shock Absorbers



MC5 to MC75 Page 18

Self-Compensating
Shock absorbers in miniature format
 Miniature slides, Pneumatic cylinders, Handling modules, Copiers

MC150 to MC600 Page 20

Self-Compensating, Rolling Diaphragm Technology
Exceptionally high endurance and with the lowest resetting force
 Linear slides, Pneumatic cylinders, Swivel units, Handling modules

MC150-V4A to MC600-V4A Page 22

Self-Compensating, Stainless Steel, Rolling Diaphragm Technology
Exceptionally high endurance with stainless steel corrosion protection
 Clean room areas, Pharmaceutical industry, Medical technology, Food industry

PMCN150 to PMCN600 Page 24

Self-Compensating, Rolling Diaphragm Technology, TPU Bellow
Reliable protection from fluids and particulate
 Finishing and processing centers, Clean room areas, Pharmaceutical industry, Medical technology

PMCN150-V4A to PMCN600-V4A Page 26

Self-Compensating, Rolling Diaphragm Technology, TPU Bellow
Optimum corrosion protection
 Finishing and processing centers, Clean room areas, Pharmaceutical industry, Medical technology

SC190 to SC925 Page 28

Self-Compensating, Soft-Contact
Long stroke and soft impact
 Linear slides, Pneumatic cylinders, Handling modules, Machines and plants

SC²25 to SC²190 Page 30

Self-Compensating, Piston Tube Technology
Piston tube design for maximum energy absorption
 Linear slides, Pneumatic cylinders, Swivel units, Handling modules

SC²300 to SC²650 Page 32

Self-Compensating, Piston Tube Technology
Piston tube design for maximum energy absorption
 Turntables, Swivel units, Robot arms, Linear slides

SC25-HC to SC650-HC Page 34

Self-Compensating
Miniature self compensating shocks for high-speed applications
 Linear slides, Tool machines, Handling modules, Production plants

MA30 to MA900 Page 36

Adjustable
Stepless adjustment
 Linear slides, Pneumatic cylinders, Swivel units, Handling modules

3/8x1 Page 38

Adjustable
Miniature adjustable shock delivers convenience
 Linear slides, Transport industry, Tool machines, Handling modules

MC5 to MC75

Shock absorbers in miniature format

Self-Compensating

Energy capacity 6 in-lbs/Cycle to 75 in-lbs/Cycle

Stroke 0.16 in to 0.40 in

Ideal for compact, efficient designs: The miniature size of the product family MC5 to MC75 delivers very short overall lengths and low return forces.

The outer body of each shock, produced from one solid piece, is filled with temperature stable oil, offers a continuous outer body thread including a supplied lock nut and also has an integrated positive stop. These maintenance-free hydraulic machine elements from ACE are ready for immediate installation. A wide range of energy absorption and effective weight are further benefits in these compact units. Self-compensating shock absorbers react to changing energy conditions, without adjustment.

These self-compensating miniature shock absorbers are perfectly suited to use in applications such as rotary actuators, automation, light industrial manufacturing, material handling and packaging equipment, medical, electronics and robotics.

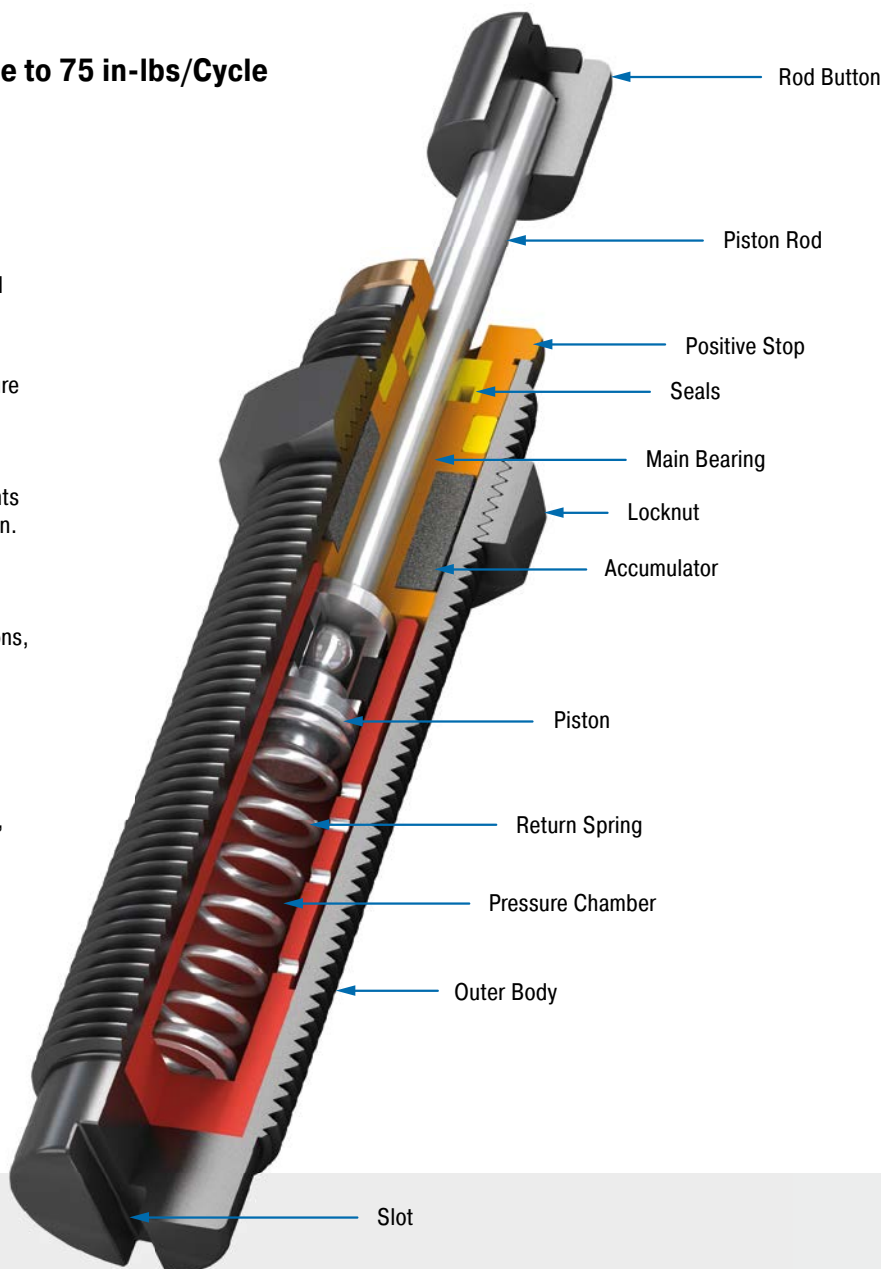

Technical Data

Energy capacity: 6 in-lbs/Cycle to 75 in-lbs/Cycle

Impact velocity range: 1.89 ft/sec to 12 ft/sec

Operating temperature range: 14 °F to 150 °F

Mounting: In any position

Positive stop: Integrated

Material: Outer body, Accessories: Steel corrosion-resistant coating; Piston rod: Hardened stainless steel; Rod end button: Steel, MC25 and MC75: Elastomer Insert; Locknut: Steel, MC5 and MC9: Aluminium

Damping medium: Oil, temperature stable

Application field: Miniature slides, Pneumatic cylinders, Handling modules, Copiers, Measuring tables, Machines and plants, Locking systems

Note: If precise end position data is required consider use of a stop collar.

Safety information: External materials in the surrounding area can attack the seal components and lead to a shorter service life. Please contact ACE for appropriate solution suggestions. Do not paint the shock absorbers due to heat emission.

On request: Increased corrosion protection. Special finishes. Models without rod end button also available on request.

MC5M

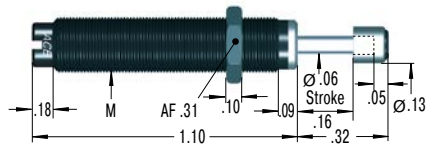

Standard version without button for MC5, MC9 and MC10

MC9M

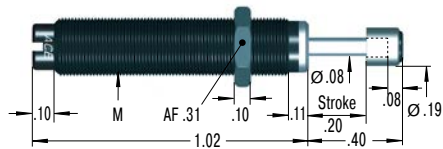

Standard version without button for MC5, MC9 and MC10

MC30M

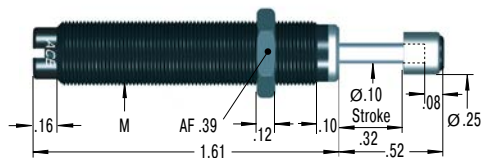

MC10M

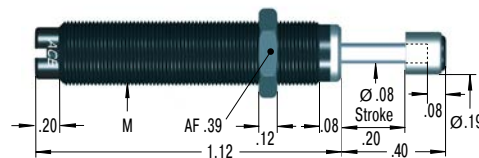

Standard version without button for MC5, MC9 and MC10
M8x0.75 also available to order

MC25

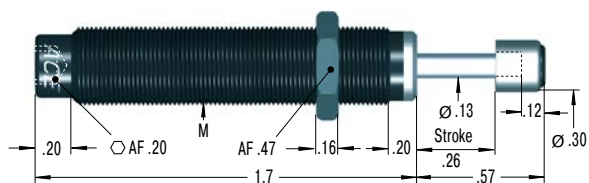

Product available for UNF and metric thread (for metric add suffix -M from part number)

250-0306

Mounting Block

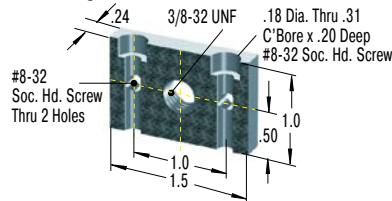

250-0307

Mounting Block

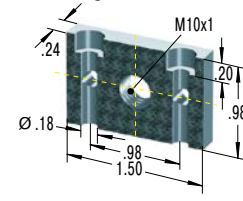

MC75

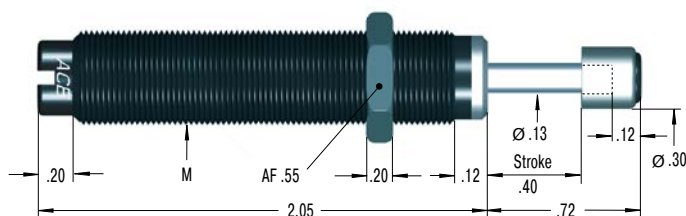

Product available for UNF and metric thread (for metric add suffix -M from part number)

250-0308

Mounting Block

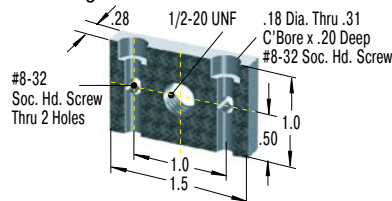

250-0309

Mounting Block

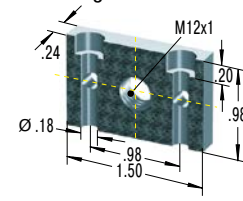

Accessories, mounting, installation ... starting on page 40.

Performance

| TYPES | Max. Energy Capacity | | Effective Weight | | Return Force min. lbs | Return Force max. lbs | Return Time s | Side Load Angle max. ° | M | Weight lbs |
|----------|-----------------------------|-------------------------|------------------|-------------|-----------------------|-----------------------|---------------|------------------------|--------------------|------------|
| | E ₃ in-lbs/cycle | E ₄ in-lbs/h | We min. lbs | We max. lbs | | | | | | |
| MC5M-1-B | 6 | 18,000 | 0.22 | 2.0 | 0.44 | 1.15 | 0.2 | 2 | M5x0.5 | 0.007 |
| MC5M-2-B | 6 | 18,000 | 1.7 | 4.9 | 0.44 | 1.15 | 0.2 | 2 | M5x0.5 | 0.007 |
| MC5M-3-B | 6 | 18,000 | 4.4 | 11.1 | 0.44 | 1.15 | 0.2 | 2 | M5x0.5 | 0.007 |
| MC9M-1-B | 9 | 18,000 | 1.35 | 7.0 | 0.31 | 0.85 | 0.3 | 2 | M6x0.5 | 0.009 |
| MC9M-2-B | 9 | 18,000 | 1.75 | 9.0 | 0.31 | 0.85 | 0.3 | 2 | M6x0.5 | 0.009 |
| MC10MH-B | 11 | 35,000 | 1.5 | 11.0 | 0.5 | 1.0 | 0.3 | 3 | M8x1 | 0.017 |
| MC10ML-B | 11 | 35,000 | 0.75 | 6.0 | 0.5 | 1.0 | 0.3 | 3 | M8x1 | 0.017 |
| MC30M-1 | 31 | 50,000 | 1.0 | 4.3 | 1.16 | 1.57 | 0.3 | 2 | M8x1 | 0.022 |
| MC30M-2 | 31 | 50,000 | 3.97 | 11.9 | 1.16 | 1.57 | 0.3 | 2 | M8x1 | 0.022 |
| MC30M-3 | 31 | 50,000 | 11.02 | 33.0 | 1.16 | 1.57 | 0.3 | 2 | M8x1 | 0.022 |
| MC25 | 20 | 200,000 | 4 | 12 | 0.8 | 1.7 | 0.2 | 2 | 3/8-32 UNF / M10x1 | 0.044 |
| MC25H | 20 | 200,000 | 10 | 30 | 0.8 | 1.7 | 0.2 | 2 | 3/8-32 UNF / M10x1 | 0.044 |
| MC25L | 20 | 200,000 | 1.5 | 5.0 | 0.8 | 1.7 | 0.2 | 2 | 3/8-32 UNF / M10x1 | 0.044 |
| MC75-1 | 75 | 250,000 | 0.5 | 2.5 | 1.0 | 2.5 | 0.3 | 2 | 1/2-20 UNF / M12x1 | 0.088 |
| MC75-2 | 75 | 250,000 | 2 | 14 | 1.0 | 2.5 | 0.3 | 2 | 1/2-20 UNF / M12x1 | 0.088 |
| MC75-3 | 75 | 250,000 | 6 | 80 | 1.0 | 2.5 | 0.3 | 2 | 1/2-20 UNF / M12x1 | 0.088 |
| MC75-4 | 75 | 250,000 | 55 | 160 | 1.0 | 2.5 | 0.3 | 2 | 1/2-20 UNF / M12x1 | 0.088 |

¹ For applications with higher side load angles consider using the side load adaptor, pages 44 to 51.

MC150 to MC600

Exceptionally high endurance and with the lowest resetting force

Self-Compensating, Rolling Diaphragm Technology
Energy capacity 175 in-lbs/Cycle to 1,200 in-lbs/Cycle
Stroke 0.50 in to 1.00 in

Tried-and-tested and durable: With a hermetically sealed rolling diaphragm in each absorber, the MC150 to MC600 product family is suitable for an exceptionally high lifetime of use with up to 25 million cycles. The rolling diaphragm technology perfected by ACE ensures complete separation of the damping fluid from the surrounding air. This makes it possible for direct installation in a pressure chamber to provide end stop damping in pneumatic cylinders up to approximately 100 psi (7 bar).

The rolling diaphragm delivers very low return forces for these maintenance-free, ready-to-install absorbers. An integrated positive stop and progressive energy capacities, with a wide range of effective weight, make these miniature shock absorbers a winner. Furthermore, the use of a side load adapter allows impact angles of up to 25°. Stainless steel options are available for greater environmental compatibility. Self-compensating shock absorbers react to changing energy conditions, without adjustment.

These self compensating miniature shock absorbers are capable of universal mounting even inside a cylinder. These shocks are ideal for use in multitude of applications including material handling equipment, packaging equipment, medium robotics and machine tools.

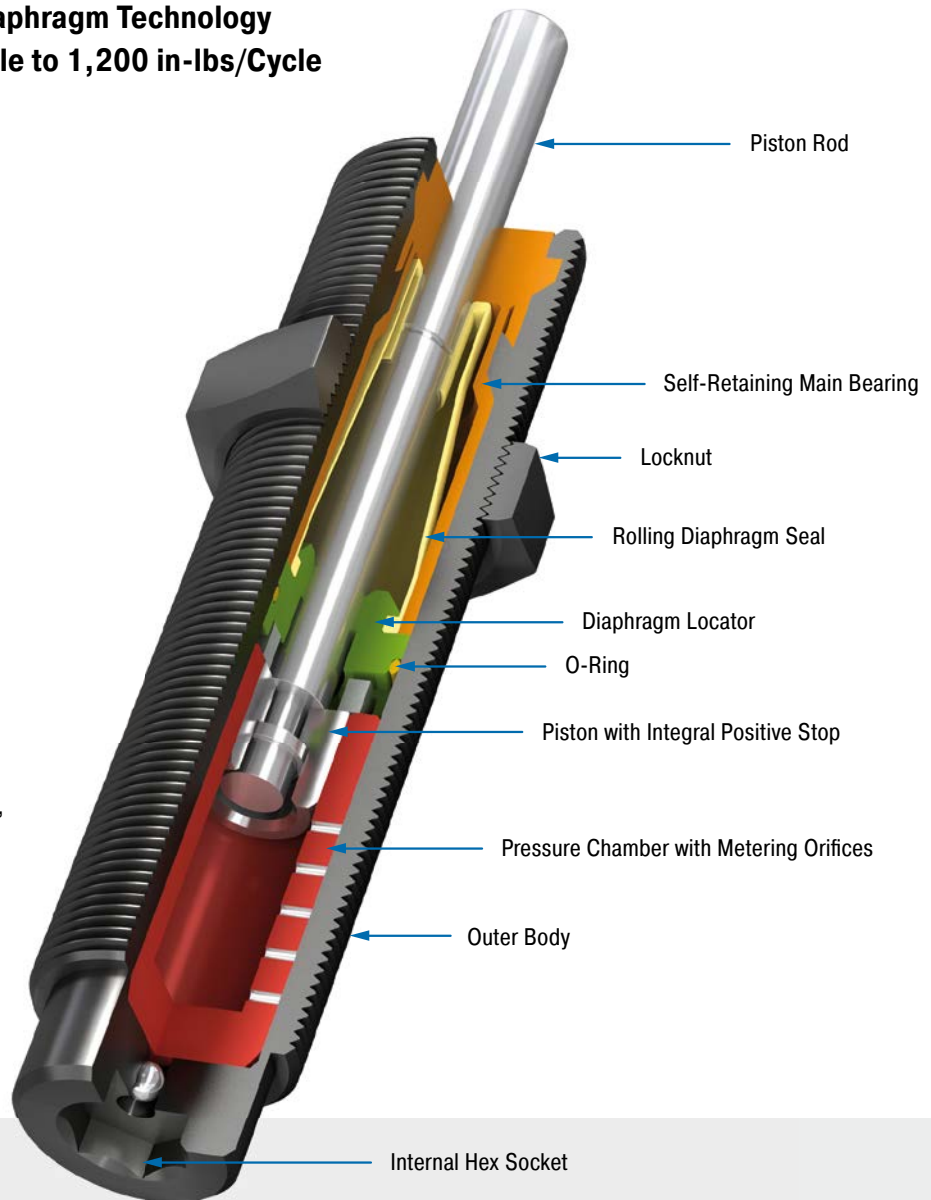

Technical Data

Energy capacity: 175 in-lbs/Cycle to 1,200 in-lbs/Cycle

Impact velocity range: 0.22 ft/sec to 19.7 ft/sec. Other speeds on request.

Operating temperature range: 32 °F to 150 °F

Mounting: In any position

Positive stop: Integrated

Material: Outer body, Accessories: Steel corrosion-resistant coating; Main bearing: Plastic; Piston rod: Hardened stainless steel (1.4125, AISI 440C); Rolling diaphragm: EPDM

Damping medium: Oil, temperature stable

Application field: Linear slides, Pneumatic cylinders, Swivel units, Handling modules, Machines and plants, Finishing and processing centers, Measuring tables, Tool machines, Locking systems

Note: If precise end position data is required consider use of a stop collar.

Safety information: External materials in the surrounding area can attack the rolling seal and lead to a shorter service life. Please contact ACE for appropriate solution suggestions. Suitable for use in pressure chambers up to 101.53 psi.

On request: Increased corrosion protection. Special threads or other special options.

MC150

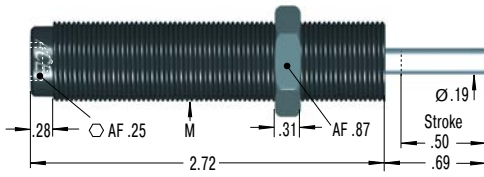

Product available for UNF and metric thread (for metric add suffix -M from part number)
M14x1 also available to special order (add suffix -ME to part number)

MC225

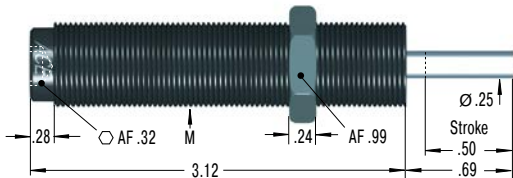

Product available for UNF and metric thread (for metric add suffix -M from part number)

MC600

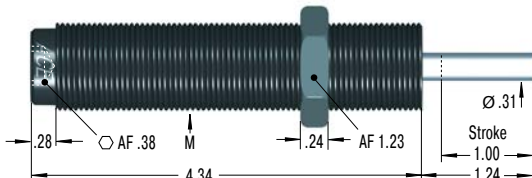

Product available for UNF and metric thread (for metric add suffix -M from part number)
M27x3 also available to special order (add suffix -ML to part number)

250-0318 Mounting Block

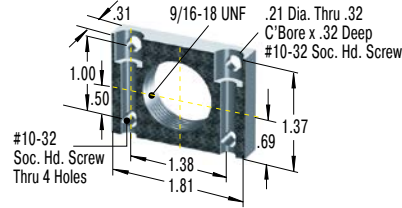

250-0352 Mounting Block

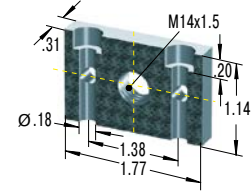

250-0401 Mounting Block

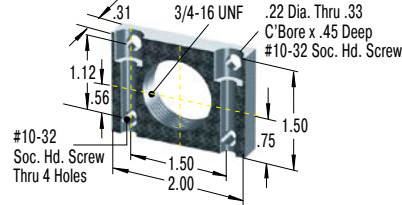

250-0353 Mounting Block

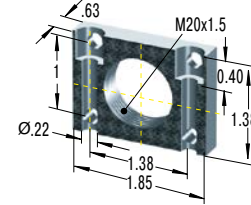

250-0402 Mounting Block

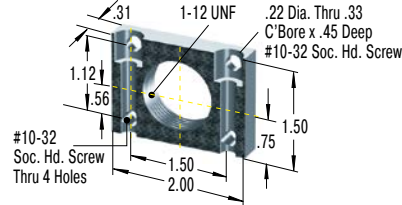

250-0044 Mounting Block

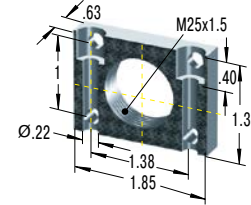

Additional accessories, mounting, installation ... starting on page 40.

Performance

| TYPES | Max. Energy Capacity | | Effective Weight | | Return Force min. lbs | Return Force max. lbs | Return Time s | Side Load Angle max. ° | M | Weight lbs |
|---------|-----------------------------|-------------------------|------------------|-------------|-----------------------|-----------------------|---------------|------------------------|-----------------------|------------|
| | E ₃ in-lbs/cycle | E ₄ in-lbs/h | We min. lbs | We max. lbs | | | | | | |
| MC150 | 175 | 300,000 | 2 | 22 | 0.7 | 1.2 | 0.4 | 4 | 9/16-18 UNF / M14x1.5 | 0.119 |
| MC150H | 175 | 300,000 | 20 | 200 | 0.7 | 1.2 | 0.4 | 4 | 9/16-18 UNF / M14x1.5 | 0.119 |
| MC150H2 | 175 | 300,000 | 150 | 450 | 0.7 | 1.2 | 0.4 | 4 | 9/16-18 UNF / M14x1.5 | 0.119 |
| MC150H3 | 175 | 300,000 | 400 | 900 | 0.7 | 1.2 | 1.0 | 4 | 9/16-18 UNF / M14x1.5 | 0.119 |
| MC225 | 360 | 400,000 | 5 | 55 | 1.0 | 1.5 | 0.3 | 4 | 3/4-16 UNF / M20x1.5 | 0.340 |
| MC225H | 360 | 400,000 | 50 | 500 | 1.0 | 1.5 | 0.3 | 4 | 3/4-16 UNF / M20x1.5 | 0.340 |
| MC225H2 | 360 | 400,000 | 400 | 2,000 | 1.0 | 1.5 | 0.3 | 4 | 3/4-16 UNF / M20x1.5 | 0.340 |
| MC225H3 | 360 | 400,000 | 1,800 | 4,000 | 1.0 | 1.5 | 0.3 | 4 | 3/4-16 UNF / M20x1.5 | 0.340 |
| MC600 | 1,200 | 600,000 | 20 | 300 | 1.0 | 2.0 | 0.6 | 2 | 1-12 UNF / M25x1.5 | 0.569 |
| MC600H | 1,200 | 600,000 | 250 | 2,500 | 1.0 | 2.0 | 0.6 | 2 | 1-12 UNF / M25x1.5 | 0.569 |
| MC600H2 | 1,200 | 600,000 | 880 | 5,000 | 1.0 | 2.0 | 0.6 | 2 | 1-12 UNF / M25x1.5 | 0.569 |
| MC600H3 | 1,200 | 600,000 | 4,800 | 10,000 | 1.0 | 2.0 | 0.6 | 2 | 1-12 UNF / M25x1.5 | 0.569 |

¹ For applications with higher side load angles consider using the side load adaptor, pages 44 to 51.

MC150-V4A to MC600-V4A

Exceptionally high endurance with stainless steel corrosion protection

Self-Compensating, Stainless Steel, Rolling Diaphragm Technology
Energy capacity 175 in-lbs/Cycle to 1,200 in-lbs/Cycle
Stroke 0.50 in to 1.00 in

Brilliant in every respect: These high performance stainless steel miniature shock absorbers are based on the MC150 to MC600 product family and its proven damping technology. This means that these special absorbers offer all of the benefits of the standard units such as the ACE rolling diaphragm technology which delivers maximum service life and direct installation in a pressure chamber with up to approx. 100 psi (7 bar).

Thanks to perfectly progressive maximum energy absorption and effective weight potential, their use is augmented even further by the stainless steel outer body and a complete range of stainless steel accessories (AISI 316L). Self-compensating shock absorbers react to changing energy conditions, without adjustment.

These self-compensating miniature stainless steel shock absorbers are used in medical and electro-technology, as well as marine, packaging, and chemical applications. Shocks can be filled with food-grade oil for food processing applications.

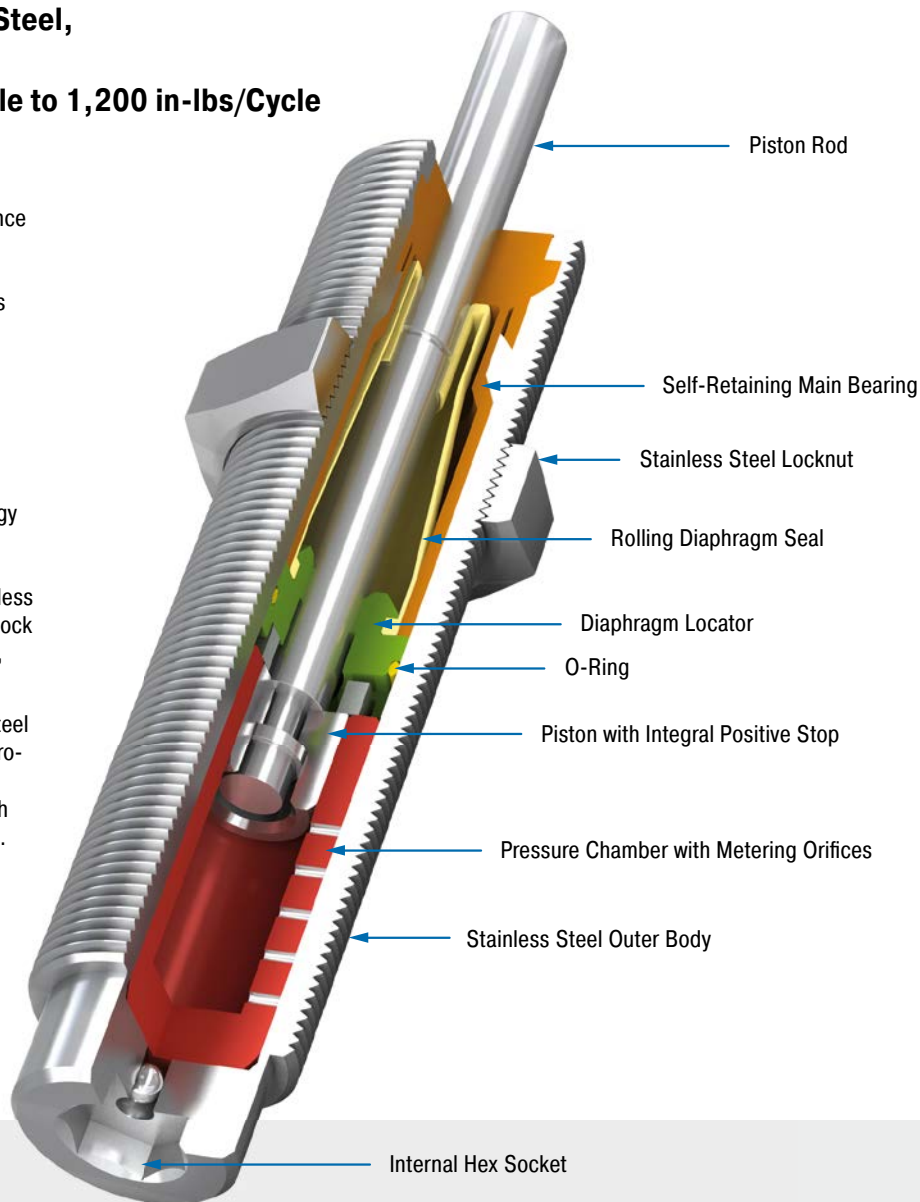

Technical Data

Energy capacity: 175 in-lbs/Cycle to 1,200 in-lbs/Cycle

Impact velocity range: 0.22 ft/sec to 19.7 ft/sec. Other speeds on request.

Operating temperature range: 32 °F to 150 °F

Mounting: In any position

Positive stop: Integrated

Material: Outer body, Locknut, Accessories: Stainless steel (1.4404, AISI 316L); Main bearing: Plastic; Piston rod: Hardened stainless steel (1.4125, AISI 440C); Rolling diaphragm: EPDM

Damping medium: Oil, temperature stable

Application field: Clean room areas, Pharmaceutical industry, Medical technology, Food industry, Linear slides, Pneumatic cylinders, Handling modules, Machines and plants, Finishing and processing centers, Measuring tables

Note: If precise end position data is required consider use of a stop collar.

Safety information: External materials in the surrounding area can attack the rolling seal and lead to a shorter service life. Please contact ACE for appropriate solution suggestions. Suitable for use in pressure chambers up to 101.53 psi.

On request: Special oil with food approval. Special threads or other special options available on request.

Self-Compensating, Stainless Steel, Rolling Diaphragm Technology

MC150M-V4A

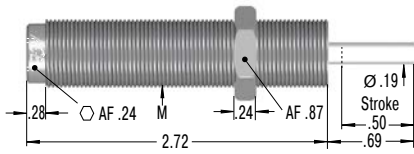

250-0753 Nylon Button

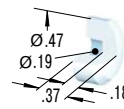

$E_3 \text{ max} = 123.91 \text{ lbs}$

250-0441 Locknut

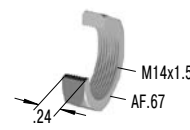

250-0255 Mounting Block

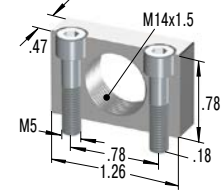

MC225M-V4A

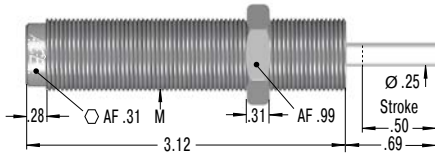

250-0754 Nylon Button

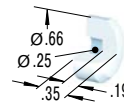

$E_3 \text{ max} = 292.07 \text{ lbs}$

250-0442 Locknut

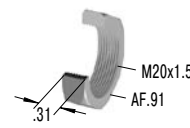

250-0434 Mounting Block

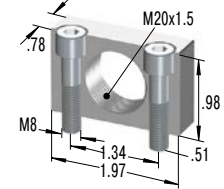

MC600M-V4A

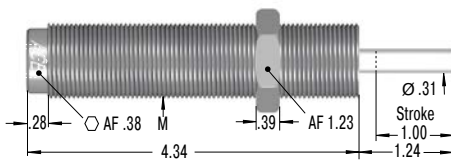

250-0755 Nylon Button

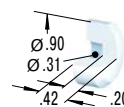

$E_3 \text{ max} = 601.85 \text{ lbs}$

250-0443 Locknut

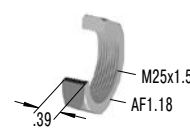

250-0436 Mounting Block

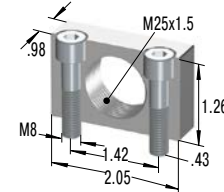

Additional accessories, mounting, installation ... starting on page 40.

Performance

| TYPES | Max. Energy Capacity | | Effective Weight | | Return Force min. lbs | Return Force max. lbs | Return Time s | Side Load Angle max. ° | M | Weight lbs |
|--------------|----------------------|----------------|------------------|-------------|-----------------------|-----------------------|---------------|------------------------|---------|------------|
| | E_3 in-lbs/cycle | E_4 in-lbs/h | We min. lbs | We max. lbs | | | | | | |
| MC150M-V4A | 175 | 300,000 | 2 | 22 | 0.7 | 1.2 | 0.4 | 4 | M14x1.5 | 0.119 |
| MC150MH-V4A | 175 | 300,000 | 20 | 200 | 0.7 | 1.2 | 0.4 | 4 | M14x1.5 | 0.119 |
| MC150MH2-V4A | 175 | 300,000 | 150 | 450 | 0.7 | 1.2 | 0.4 | 4 | M14x1.5 | 0.119 |
| MC150MH3-V4A | 175 | 300,000 | 400 | 900 | 0.7 | 1.2 | 1.0 | 4 | M14x1.5 | 0.119 |
| MC225M-V4A | 360 | 400,000 | 5 | 55 | 1.0 | 1.5 | 0.3 | 4 | M20x1.5 | 0.340 |
| MC225MH-V4A | 360 | 400,000 | 50 | 500 | 1.0 | 1.5 | 0.3 | 4 | M20x1.5 | 0.340 |
| MC225MH2-V4A | 360 | 400,000 | 400 | 2,000 | 1.0 | 1.5 | 0.3 | 4 | M20x1.5 | 0.340 |
| MC225MH3-V4A | 360 | 400,000 | 1,800 | 4,000 | 1.0 | 1.5 | 0.3 | 4 | M20x1.5 | 0.340 |
| MC600M-V4A | 1,200 | 600,000 | 20 | 300 | 1.0 | 2.0 | 0.6 | 2 | M25x1.5 | 0.569 |
| MC600MH-V4A | 1,200 | 600,000 | 250 | 2,500 | 1.0 | 2.0 | 0.6 | 2 | M25x1.5 | 0.569 |
| MC600MH2-V4A | 1,200 | 600,000 | 880 | 5,000 | 1.0 | 2.0 | 0.6 | 2 | M25x1.5 | 0.569 |
| MC600MH3-V4A | 1,200 | 600,000 | 4,800 | 10,000 | 1.0 | 2.0 | 0.6 | 2 | M25x1.5 | 0.569 |

¹ For applications with higher side load angles please contact ACE.

PMCN150 to PMCN600

Reliable protection from fluids and particulate

Self-Compensating, Rolling Diaphragm Technology, TPU Bellow

**Energy capacity 175 in-lbs/Cycle to 1,200 in-lbs/Cycle
Stroke 0.50 in to 1.00 in**

Hermetically sealed: The shock absorbers from the ACE Protection family PMCN have a compact, perfectly sealed cap as a special feature.

This protection bellows, made of TPU (thermoplastic polyurethane), safely encapsulates the proven ACE rolling diaphragm from the outside environment. Aggressive cutting, lubricating and cleaning agents don't stand a chance and the function of the maintenance-free, ready-to-install shock absorber is retained. They are also available in full stainless steel.

The PMCN range is a good alternative to the SP type air bleed collar if no compressed air is available on the machine or system.

Reliable protection against aggressive environments including fluids and abrasives, these self-compensating miniature shock absorbers are the first choice where conventional dampers wear out too quickly. Use them in harsh environments where cutting, cooling or cleaning agents can attack.

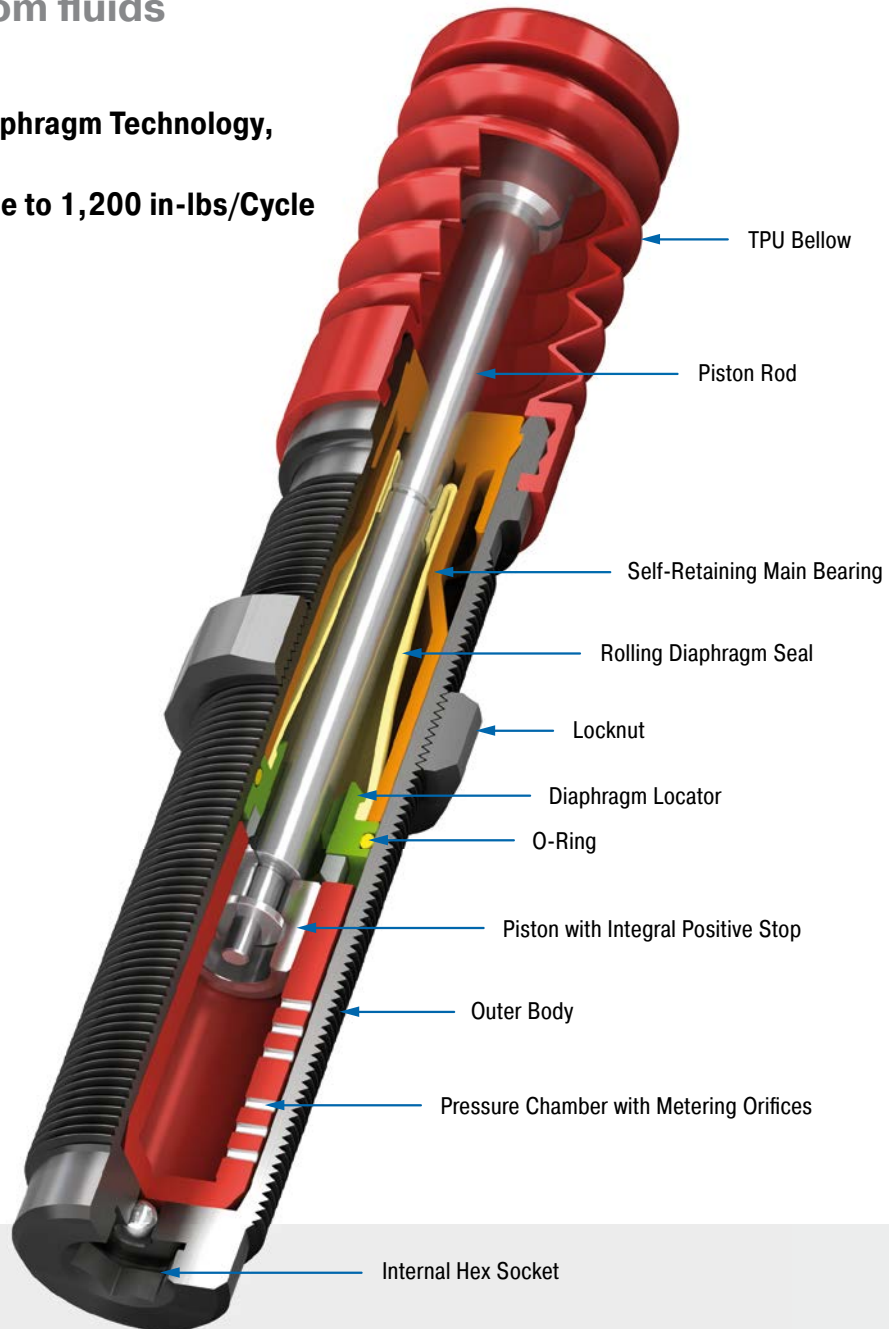

Technical Data

Energy capacity: 175 in-lbs/Cycle to 1,200 in-lbs/Cycle

Impact velocity range: 0.22 ft/sec to 19.7 ft/sec. Other speeds on request.

Operating temperature range: 32 °F to 150 °F

Mounting: In any position

Positive stop: Integrated

Material: Outer body: Steel corrosion-resistant coating; Main bearing: Plastic; Piston rod: Hardened stainless steel (1.4125, AISI 440C); Bellow: TPU, steel insert: Stainless steel (1.4404/1.4571, AISI 316L/316Ti); Rolling diaphragm: EPDM

Damping medium: Oil, temperature stable

Application field: Finishing and processing centers, Clean room areas, Pharmaceutical industry, Medical technology, Food industry, Linear slides, Pneumatic cylinders, Machines and plants

Note: Final preliminary test must be done on the application.

Safety information: Do not paint the shock absorbers due to heat emission.

On request: Special accessories available on request.

Self-Compensating, Rolling Diaphragm Technology, TPU Bellow

PMCN150M

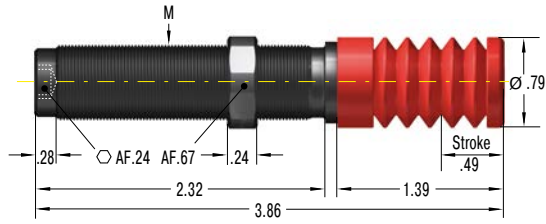

250-0233 Locknut



250-0352 Mounting Block

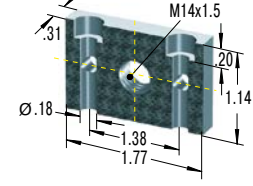

PMCN225M

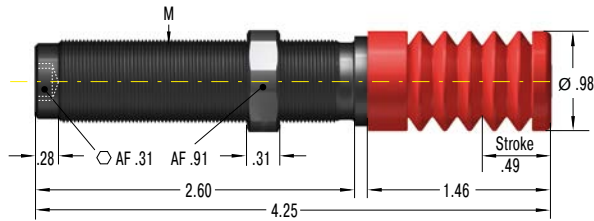

250-0207 Locknut



250-0353 Mounting Block

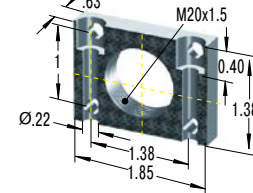

PMCN600M

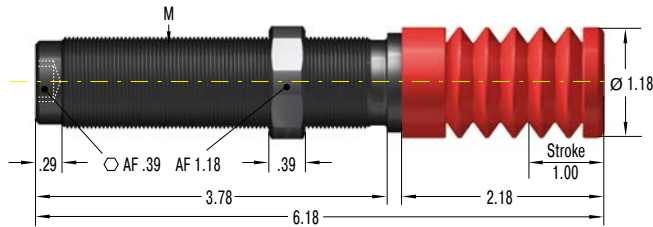

250-0040 Locknut

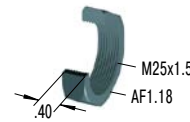

250-0044 Mounting Block

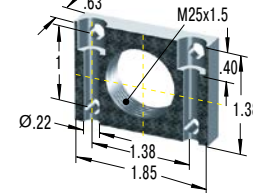

Additional accessories, mounting, installation ... starting on page 40.

Performance

| TYPES | Max. Energy Capacity | | Effective Weight | | Return Force min. lbs | Return Force max. lbs | Return Time s | Side Load Angle max. ° | M | Weight lbs |
|------------|-----------------------------|-------------------------|------------------|-------------|-----------------------|-----------------------|---------------|------------------------|---------|------------|
| | E ₃ in-lbs/cycle | E ₄ in-lbs/h | We min. lbs | We max. lbs | | | | | | |
| PMCN150M | 175 | 300,000 | 2 | 22 | 1.80 | 17.98 | 1.0 | 4 | M14x1.5 | 0.148 |
| PMCN150MH | 175 | 300,000 | 20 | 190 | 1.80 | 17.98 | 1.0 | 4 | M14x1.5 | 0.148 |
| PMCN150MH2 | 175 | 300,000 | 155 | 440 | 1.80 | 17.98 | 1.0 | 4 | M14x1.5 | 0.148 |
| PMCN150MH3 | 175 | 300,000 | 400 | 900 | 1.80 | 17.98 | 1.0 | 4 | M14x1.5 | 0.148 |
| PMCN225M | 360 | 400,000 | 5 | 50 | 1.80 | 19.11 | 0.3 | 4 | M20x1.5 | 0.375 |
| PMCN225MH | 360 | 400,000 | 50 | 510 | 1.80 | 19.11 | 0.3 | 4 | M20x1.5 | 0.375 |
| PMCN225MH2 | 360 | 400,000 | 400 | 2,000 | 1.80 | 19.11 | 0.3 | 4 | M20x1.5 | 0.375 |
| PMCN225MH3 | 360 | 400,000 | 1,800 | 4,000 | 1.80 | 19.11 | 0.3 | 4 | M20x1.5 | 0.375 |
| PMCN600M | 1,200 | 600,000 | 20 | 300 | 1.80 | 20.23 | 0.6 | 2 | M25x1.5 | 0.699 |
| PMCN600MH | 1,200 | 600,000 | 250 | 2,490 | 1.80 | 20.23 | 0.6 | 2 | M25x1.5 | 0.699 |
| PMCN600MH2 | 1,200 | 600,000 | 880 | 5,000 | 1.80 | 20.23 | 0.6 | 2 | M25x1.5 | 0.699 |
| PMCN600MH3 | 1,200 | 600,000 | 4,800 | 10,000 | 1.80 | 20.23 | 0.6 | 2 | M25x1.5 | 0.699 |

PMCN150-V4A to PMCN600-V4A

Optimum corrosion protection

Self-Compensating, Rolling Diaphragm Technology, TPU Bellow

Energy capacity 175 in-lbs/Cycle to 1,200 in-lbs/Cycle
Stroke 0.50 in to 1.00 in

Hermetically sealed and rustproof: The Protection product family PMCN is also available in a stainless steel design. This is of particular interest to the food and packaging industries.

Their main feature is the compact, totally sealed bellow between the body and the cap made of TPU (thermoplastic polyurethane). This protection safely encapsulates the ACE rolling diaphragm from the outside environment. Aggressive fluids don't stand a chance.

The PMCN range is an excellent alternative if the accessory option of the SP type air bleed collar cannot be used due to a lack of compressed air.

The PMCN range self-compensating miniature shock absorbers, produced from stainless steel, are primarily suitable for use in the food industry, but are also wherever a high-quality appearance is important e.g. in shipbuilding.

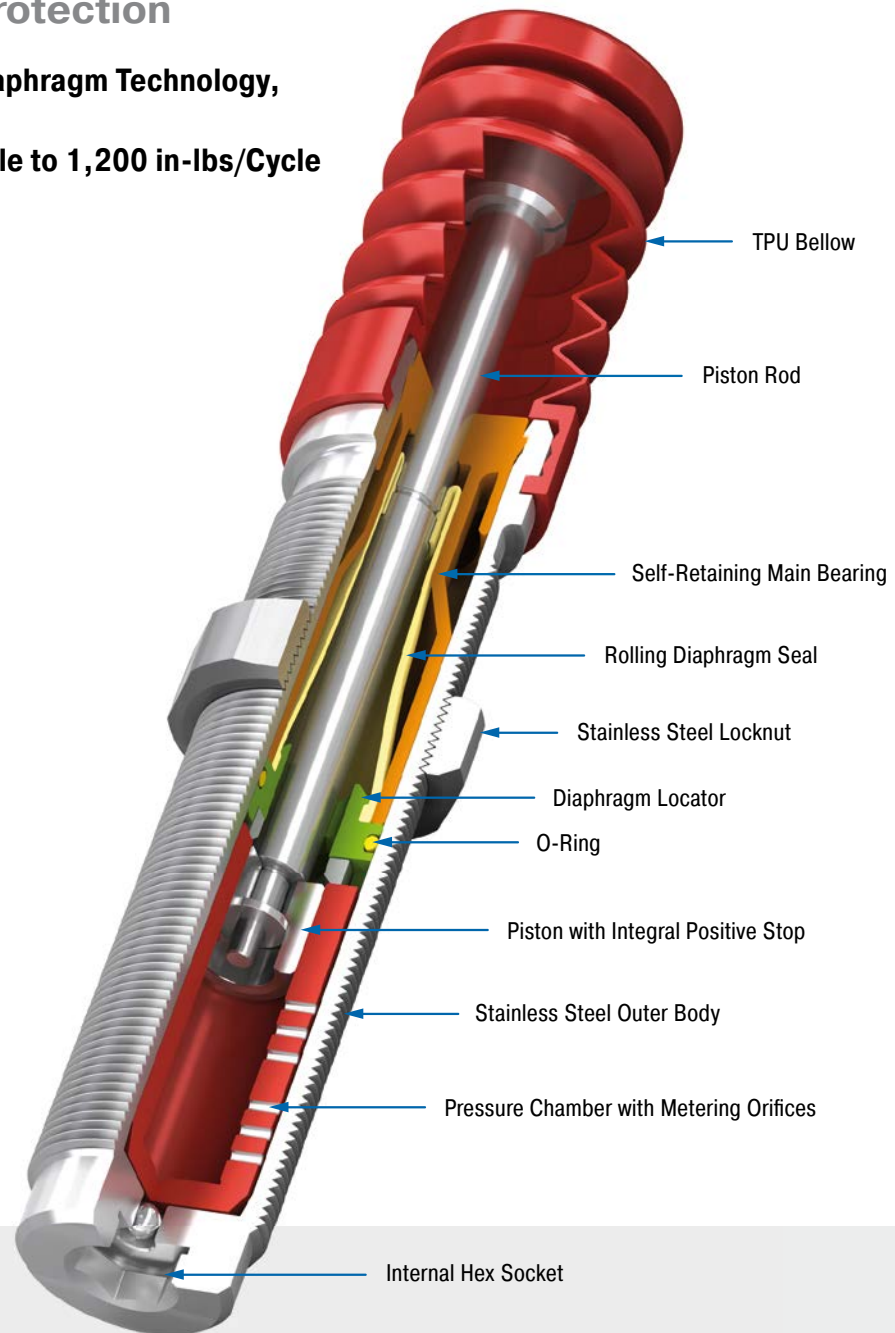

Technical Data

Energy capacity: 175 in-lbs/Cycle to 1,200 in-lbs/Cycle

Impact velocity range: 0.26 ft/sec to 19.7 ft/sec. Other speeds on request.

Operating temperature range: 32 °F to 150 °F

Mounting: In any position

Positive stop: Integrated

Material: Outer body: Stainless steel (1.4404, AISI 316L); Main bearing: Plastic; Piston rod: Hardened stainless steel (1.4125, AISI 440C); Bellow: TPU, steel insert: Stainless steel (1.4404/1.4571, AISI 316L/316Ti); Rolling diaphragm: EPDM

Damping medium: Oil, temperature stable

Application field: Finishing and processing centers, Clean room areas, Pharmaceutical industry, Medical technology, Food industry, Machines and plants

Note: Final preliminary test must be done on the application.

Safety information: Do not paint the shock absorbers due to heat emission.

On request: Special accessories available on request.

PMCN150M-V4A

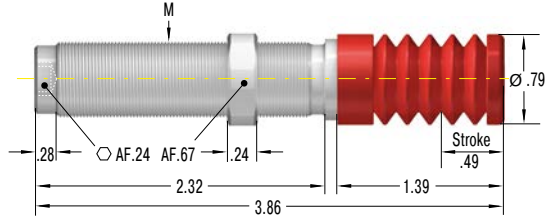

250-0441 Locknut

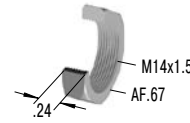

250-0255 Mounting Block

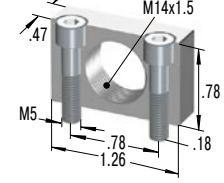

PMCN225M-V4A

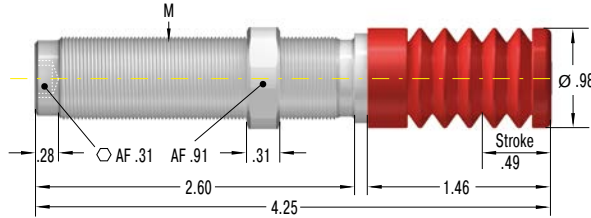

250-0442 Locknut

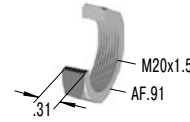

250-0434 Mounting Block

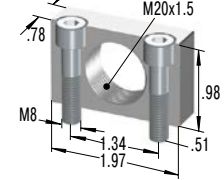

PMCN600M-V4A

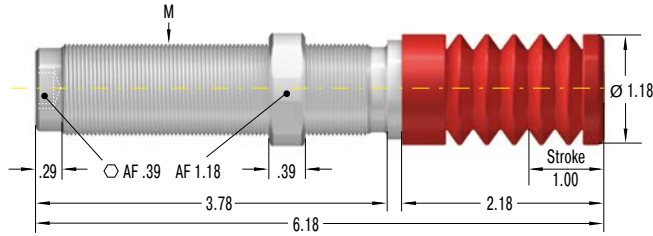

250-0443 Locknut

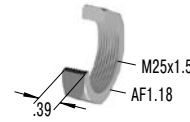

250-0436 Mounting Block

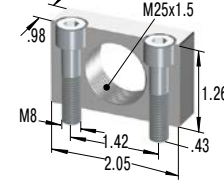

Additional accessories, mounting, installation ... starting on page 40.

Performance

| TYPES | Max. Energy Capacity | | Effective Weight | | Return Force min. lbs | Return Force max. lbs | Return Time s | Side Load Angle max. ° | M | Weight lbs |
|----------------|-----------------------------|-------------------------|------------------|-------------|-----------------------|-----------------------|---------------|------------------------|---------|------------|
| | E ₃ in-lbs/cycle | E ₄ in-lbs/h | We min. lbs | We max. lbs | | | | | | |
| PMCN150M-V4A | 175 | 300,000 | 2 | 22 | 1.80 | 17.98 | 1.0 | 4 | M14x1.5 | 0.148 |
| PMCN150MH-V4A | 175 | 300,000 | 20 | 190 | 1.80 | 17.98 | 1.0 | 4 | M14x1.5 | 0.148 |
| PMCN150MH2-V4A | 175 | 300,000 | 155 | 440 | 1.80 | 17.98 | 1.0 | 4 | M14x1.5 | 0.148 |
| PMCN150MH3-V4A | 175 | 300,000 | 400 | 900 | 1.80 | 17.98 | 1.0 | 4 | M14x1.5 | 0.148 |
| PMCN225M-V4A | 360 | 400,000 | 5 | 55 | 1.80 | 19.11 | 0.3 | 4 | M20x1.5 | 0.375 |
| PMCN225MH-V4A | 360 | 400,000 | 50 | 510 | 1.80 | 19.11 | 0.3 | 4 | M20x1.5 | 0.375 |
| PMCN225MH2-V4A | 360 | 400,000 | 400 | 2,000 | 1.80 | 19.11 | 0.3 | 4 | M20x1.5 | 0.375 |
| PMCN225MH3-V4A | 360 | 400,000 | 1,800 | 4,000 | 1.80 | 19.11 | 0.3 | 4 | M20x1.5 | 0.375 |
| PMCN600M-V4A | 1,200 | 600,000 | 20 | 300 | 1.80 | 20.23 | 0.6 | 2 | M25x1.5 | 0.699 |
| PMCN600MH-V4A | 1,200 | 600,000 | 250 | 2,490 | 1.80 | 20.23 | 0.6 | 2 | M25x1.5 | 0.699 |
| PMCN600MH2-V4A | 1,200 | 600,000 | 880 | 5,000 | 1.80 | 20.23 | 0.6 | 2 | M25x1.5 | 0.699 |
| PMCN600MH3-V4A | 1,200 | 600,000 | 4,800 | 10,000 | 1.80 | 20.23 | 0.6 | 2 | M25x1.5 | 0.699 |

SC190 to SC925

Long stroke and soft impact

Self-Compensating, Soft-Contact

Energy capacity 225 in-lbs/Cycle to 975 in-lbs/Cycle

Stroke 0.63 in to 1.58 in

Ideal for soft damping: the SC found in the model code from the ACE product family SC190 to SC925 stands for 'soft contact'. These miniature shock absorbers manufactured from one solid piece are designed in such a way that they can be setup with a linear or a progressive braking curve. The soft damping character is thanks to the special, long strokes which produce smooth deceleration and low reaction forces.

These maintenance-free, ready-to-install hydraulic machine elements are equipped with an integrated positive stop. The use of side load adapter allows impact angles of up to 25°. Thanks to the designed overlapping effective weight ranges, these dampers cover an effective load range of 3 lbs. to 4,400 lbs! Self-compensating shock absorbers react to changing energy conditions, without adjustment.

These miniature self-compensating shock absorbers from the SC190 to SC925 product family are used in industrial, automation and machine engineering and primarily in the areas of handling and automation.

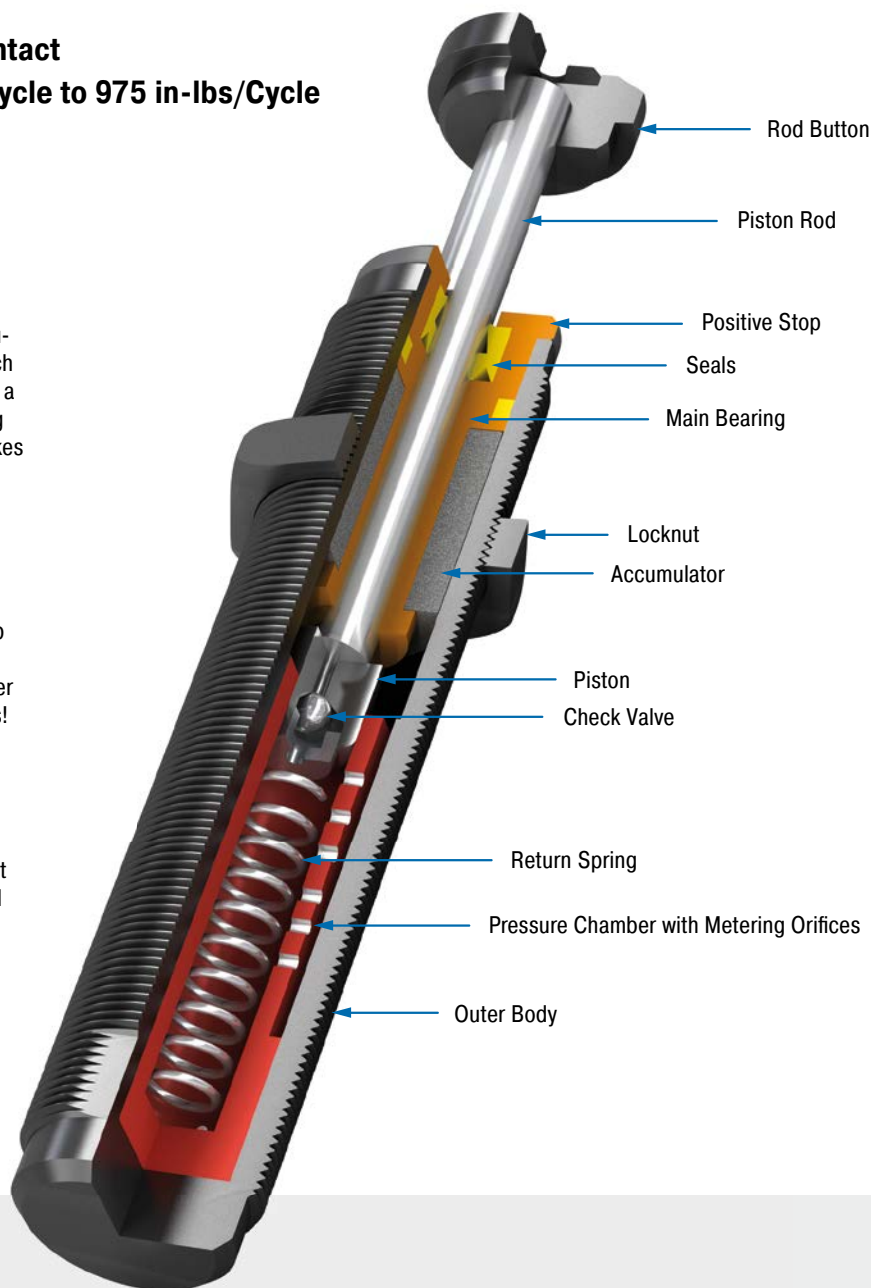

Technical Data

Energy capacity: 225 in-lbs/Cycle to 975 in-lbs/Cycle

Impact velocity range: 0.5 ft/sec to 12 ft/sec. Other speeds on request.

Operating temperature range: 32 °F to 150 °F

Mounting: In any position

Positive stop: Integrated

Material: Outer body, Accessories: Steel corrosion-resistant coating; Piston rod: Hardened stainless steel

Damping medium: Oil, temperature stable

Application field: Linear slides, Pneumatic cylinders, Handling modules, Machines and

plants, Finishing and processing centers, Measuring tables, Tool machines

Note: If precise end position data is required consider use of a stop collar.

Safety information: External materials in the surrounding area can attack the seal components and lead to a shorter service life. Please contact ACE for appropriate solution suggestions. Do not paint the shock absorbers due to heat emission.

On request: Nickel-plated or weartec finish (seawater resistant) or other special finishes available to special order. Models without rod end button.

SC190; 0 to 4

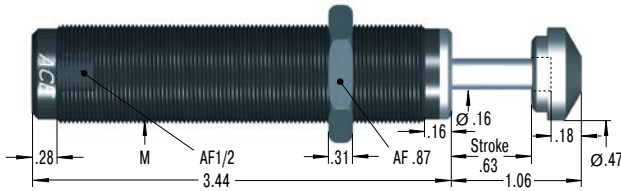

Product available for UNF and metric thread (for metric add suffix -M from part number)

250-0318 Mounting Block

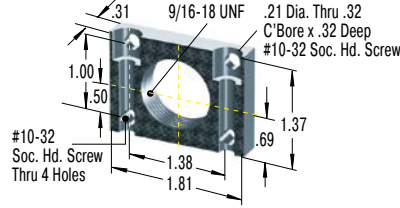

250-0352 Mounting Block

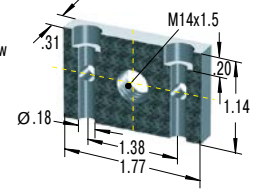

SC300; 0 to 4

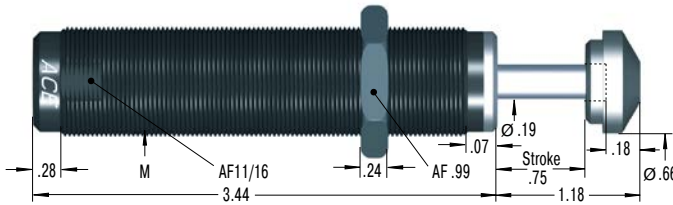

Product available for UNF and metric thread (for metric add suffix -M from part number)

250-0401 Mounting Block

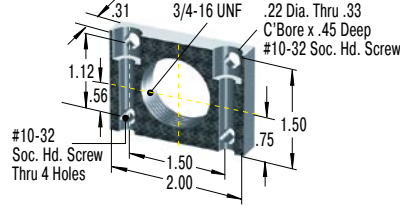

250-0353 Mounting Block

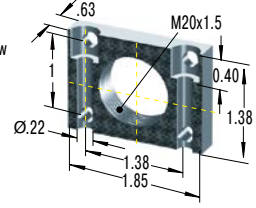

SC650; 0 to 4

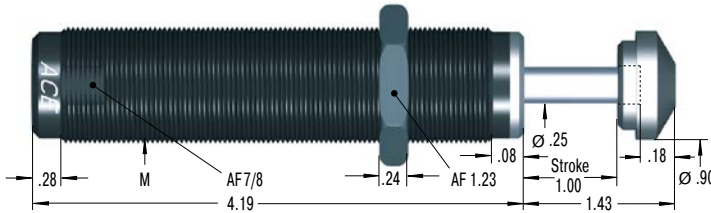

Product available for UNF and metric thread (for metric add suffix -M from part number)

250-0402 Mounting Block

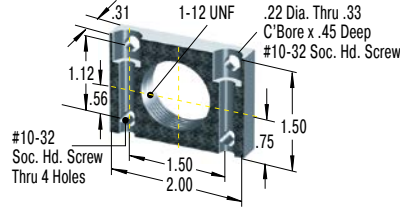

250-0044 Mounting Block

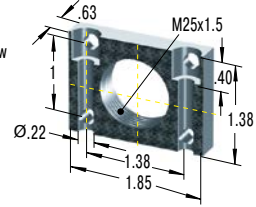

SC925; 0 to 4

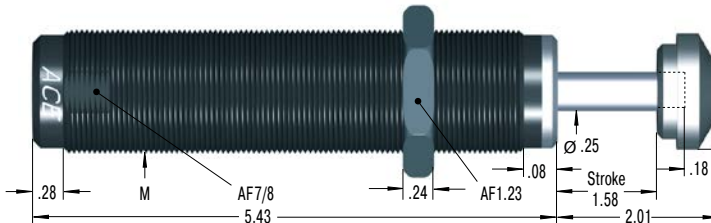

Product available for UNF and metric thread (for metric add suffix -M from part number)

250-0402 Mounting Block

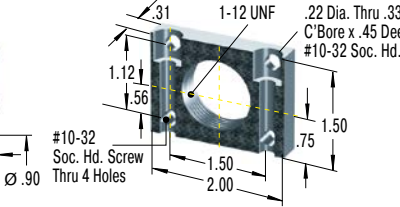

250-0044 Mounting Block

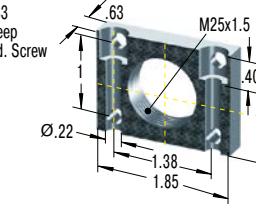

Additional accessories, mounting, installation ... starting on page 40.

Performance

| TYPES | Max. Energy Capacity | | Effective Weight | | | | Hardness | Return Force min. lbs | Return Force max. lbs | Return Time s | 1 Side Load Angle max. ° | M | Weight lbs |
|---------|-----------------------------|-------------------------|------------------|-------------|-------------------|-------------|----------|-----------------------|-----------------------|---------------|--------------------------|-----------------------|------------|
| | E ₃ in-lbs/cycle | E ₄ in-lbs/h | Soft-Contact | | Self-Compensating | | | | | | | | |
| | | | We min. lbs | We max. lbs | We min. lbs | We max. lbs | | | | | | | |
| SC190-0 | 225 | 300,000 | - | - | 1 | 9 | -0 | 0.9 | 1.9 | 0.25 | 5 | 9/16-18 UNF / M14x1.5 | 0.176 |
| SC190-1 | 225 | 300,000 | 5 | 13 | 3 | 15 | -1 | 0.9 | 1.9 | 0.25 | 5 | 9/16-18 UNF / M14x1.5 | 0.176 |
| SC190-2 | 225 | 300,000 | 12 | 36 | 8 | 40 | -2 | 0.9 | 1.9 | 0.25 | 5 | 9/16-18 UNF / M14x1.5 | 0.176 |
| SC190-3 | 225 | 300,000 | 30 | 90 | 20 | 100 | -3 | 0.9 | 1.9 | 0.25 | 5 | 9/16-18 UNF / M14x1.5 | 0.176 |
| SC190-4 | 225 | 300,000 | 75 | 200 | 50 | 225 | -4 | 0.9 | 1.9 | 0.25 | 5 | 9/16-18 UNF / M14x1.5 | 0.176 |
| SC300-0 | 300 | 400,000 | - | - | 1 | 4 | -0 | 1.05 | 2.15 | 0.1 | 5 | 3/4-16 UNF / M20x1.5 | 0.386 |
| SC300-1 | 300 | 400,000 | 5 | 15 | 3 | 18 | -1 | 1.05 | 2.15 | 0.1 | 5 | 3/4-16 UNF / M20x1.5 | 0.386 |
| SC300-2 | 300 | 400,000 | 15 | 50 | 10 | 60 | -2 | 1.05 | 2.15 | 0.1 | 5 | 3/4-16 UNF / M20x1.5 | 0.386 |
| SC300-3 | 300 | 400,000 | 50 | 150 | 30 | 180 | -3 | 1.05 | 2.15 | 0.1 | 5 | 3/4-16 UNF / M20x1.5 | 0.386 |
| SC300-4 | 300 | 400,000 | 150 | 400 | 70 | 450 | -4 | 1.05 | 2.15 | 0.1 | 5 | 3/4-16 UNF / M20x1.5 | 0.386 |
| SC650-0 | 650 | 600,000 | - | - | 5 | 31 | -0 | 2.4 | 6.87 | 0.20 | 5 | 1-12 UNF / M25x1.5 | 0.739 |
| SC650-1 | 650 | 600,000 | 24 | 80 | 17 | 100 | -1 | 2.4 | 6.87 | 0.20 | 5 | 1-12 UNF / M25x1.5 | 0.739 |
| SC650-2 | 650 | 600,000 | 75 | 250 | 50 | 300 | -2 | 2.4 | 6.87 | 0.20 | 5 | 1-12 UNF / M25x1.5 | 0.335 |
| SC650-3 | 650 | 600,000 | 240 | 800 | 150 | 900 | -3 | 2.4 | 6.87 | 0.20 | 5 | 1-12 UNF / M25x1.5 | 0.335 |
| SC650-4 | 650 | 600,000 | 800 | 2,400 | 450 | 2,600 | -4 | 2.4 | 6.87 | 0.20 | 5 | 1-12 UNF / M25x1.5 | 0.335 |
| SC925-0 | 975 | 800,000 | 18 | 55 | 10 | 65 | -0 | 2.4 | 7.4 | 0.40 | 5 | 1-12 UNF / M25x1.5 | 0.420 |
| SC925-1 | 975 | 800,000 | 50 | 160 | 30 | 200 | -1 | 2.4 | 7.4 | 0.40 | 5 | 1-12 UNF / M25x1.5 | 0.420 |
| SC925-2 | 975 | 800,000 | 130 | 460 | 90 | 600 | -2 | 2.4 | 7.4 | 0.40 | 5 | 1-12 UNF / M25x1.5 | 0.420 |
| SC925-3 | 975 | 800,000 | 400 | 1,350 | 250 | 1,600 | -3 | 2.4 | 7.4 | 0.40 | 5 | 1-12 UNF / M25x1.5 | 0.420 |
| SC925-4 | 975 | 800,000 | 1,200 | 4,300 | 750 | 4,600 | -4 | 2.4 | 7.4 | 0.40 | 5 | 1-12 UNF / M25x1.5 | 0.420 |

¹ For applications with higher side load angles consider using the side load adaptor, pages 44 to 51.

SC²25 to SC²190

Piston tube design for maximum energy absorption

Self-Compensating, Piston Tube Technology

Energy capacity 89 in-lbs/Cycle to 274 in-lbs/Cycle

Stroke 0.32 in to 0.47 in

Soft damping, but enormous capacity: The range of 'soft contact' absorbers SC²25 to SC²190 extends from thread size M10 to M14 and covers effective weight ranges of 2.2 to 3,400 lbs (1 kg to 1,550 kg). All models are characterised by high energy absorption and they also unite the piston tube technology with the diaphragm seal perfected by ACE. This enables direct installation as end position damping in pneumatic cylinders at 72 to 102 psi (5 to 7 bar) or applications where deceleration needs to take place close to the pivot point.

They are maintenance-free, have an integrated positive stop and are mountable in any position. The option of a side load adapter allows impact angles of up to 25°. They offer soft contact deceleration where initial impact reaction forces are very low, with the advantages of self-compensation to react to changing energy conditions, without adjustment.

Thanks to their robust design and their durability, these miniature shock absorbers can be used for a wide range of applications. Designers mainly use them for pick and place systems, pneumatic rotary modules and in automation applications.

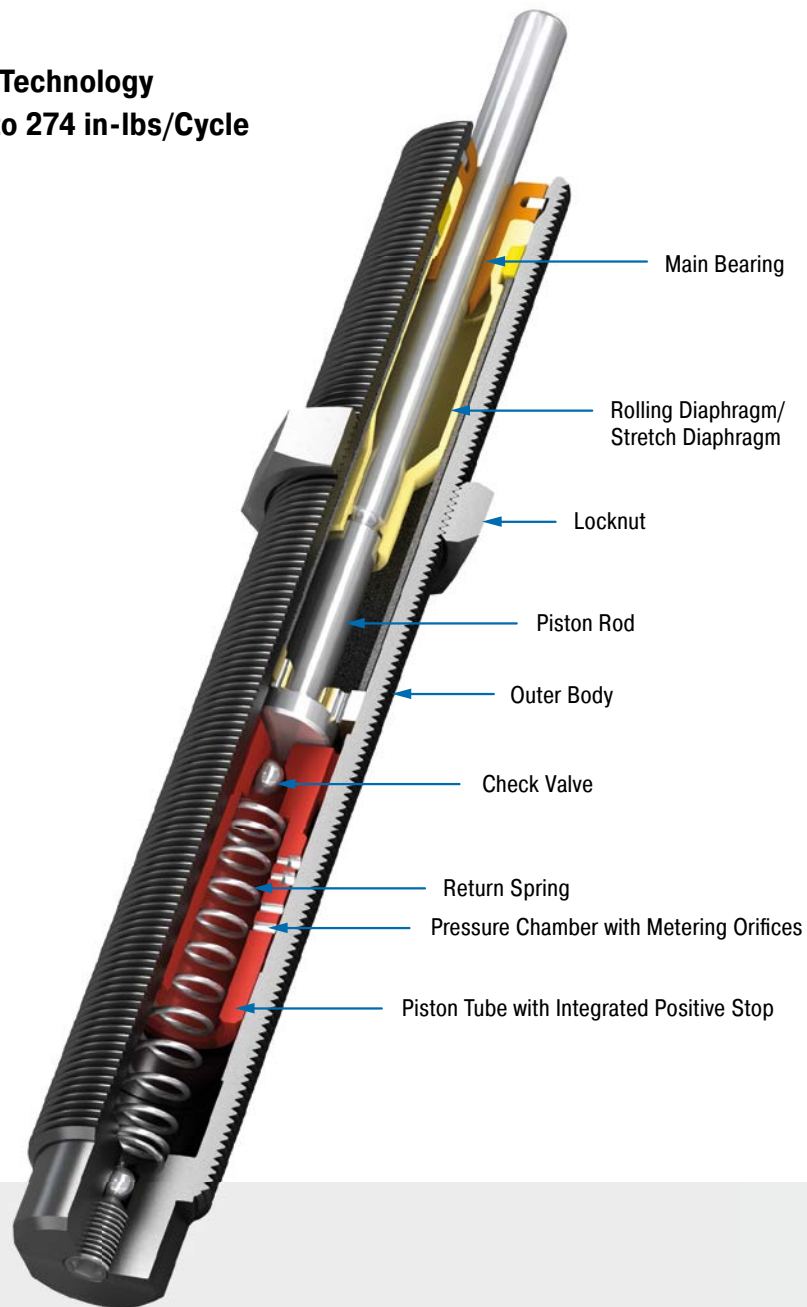

Technical Data

Energy capacity: 89 in-lbs/Cycle to 274 in-lbs/Cycle

Impact velocity range: 0.29 ft/sec to 18.6 ft/sec. Other speeds on request.

Operating temperature range: 32 °F to 150 °F

Mounting: In any position

Positive stop: Integrated

Material: Outer body, Accessories: Steel corrosion-resistant coating; Piston rod: Hardened stainless steel; Rolling diaphragm: SC²190: EPDM; Stretch diaphragm: SC²25 and SC²75: Nitrile

Damping medium: Oil, temperature stable

Application field: Linear slides, Pneumatic cylinders, Swivel units, Handling modules, Machines and plants, Finishing and processing centers, Measuring tables, Tool machines, Locking systems

Note: If precise end position data is required consider use of a stop collar.

Safety information: External materials in the surrounding area can attack the rolling and stretch seals and lead to a shorter service life. Please contact ACE for appropriate solution suggestions.

On request: Increased corrosion protection. Special finishes.

Self-Compensating, Piston Tube Technology

SC25M; 5 to 7

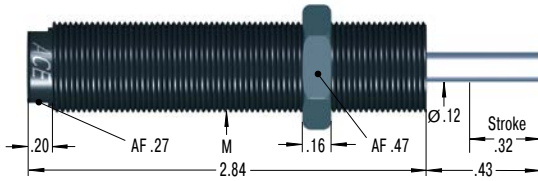

250-0315 Locknut

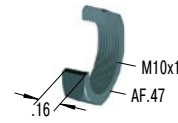

250-0307 Mounting Block

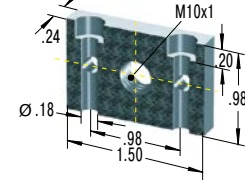

SC75M; 5 to 7

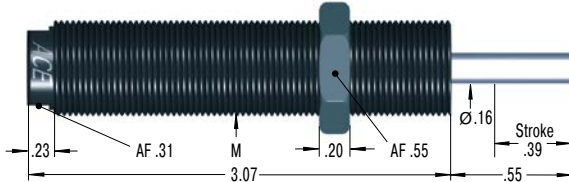

250-0317 Locknut

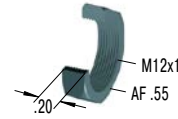

250-0309 Mounting Block

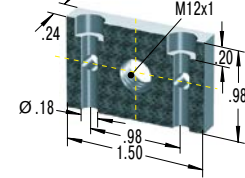

SC190M; 5 to 7

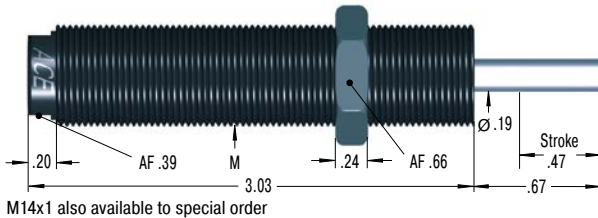

250-0233 Locknut



250-0352 Mounting Block

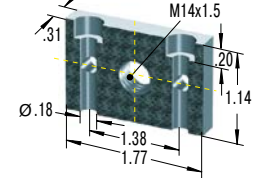

Additional accessories, mounting, installation ... starting on page 40.

Performance

| TYPES | Max. Energy Capacity | | Effective Weight | | | Return Force min. lbs | Return Force max. lbs | Return Time s | ¹ Side Load Angle max. ° | M | Weight lbs |
|----------|--------------------------------|----------------------------|------------------|----------------|----------|-----------------------------|-----------------------------|------------------|---|---------|---------------|
| | E ₃ in-lbs/cycle | E ₄ in-lbs/h | We min. lbs | We max. lbs | Hardness | | | | | | |
| SC25M-5 | 89 | 142,000 | 2 | 11 | -5 | 0.90 | 3.07 | 0.3 | 2 | M10x1 | 0.064 |
| SC25M-6 | 89 | 142,000 | 9 | 97 | -6 | 0.90 | 3.07 | 0.3 | 2 | M10x1 | 0.064 |
| SC25M-7 | 89 | 142,000 | 93 | 1,100 | -7 | 0.90 | 3.07 | 0.3 | 2 | M10x1 | 0.064 |
| SC75M-5 | 142 | 266,000 | 2 | 18 | -5 | 0.69 | 3.40 | 0.4 | 2 | M12x1 | 0.104 |
| SC75M-6 | 142 | 266,000 | 15 | 272 | -6 | 0.69 | 3.40 | 0.4 | 2 | M12x1 | 0.104 |
| SC75M-7 | 142 | 266,000 | 165 | 1,760 | -7 | 0.69 | 3.40 | 0.4 | 2 | M12x1 | 0.104 |
| SC190M-5 | 274 | 443,000 | 4 | 35 | -5 | 0.97 | 5.57 | 0.4 | 2 | M14x1.5 | 0.130 |
| SC190M-6 | 274 | 443,000 | 29 | 309 | -6 | 0.97 | 5.57 | 0.4 | 2 | M14x1.5 | 0.130 |
| SC190M-7 | 274 | 443,000 | 300 | 3,400 | -7 | 0.97 | 5.57 | 0.4 | 2 | M14x1.5 | 0.130 |

¹ For applications with higher side load angles consider using the side load adaptor, pages 44 to 51.

SC²300 to SC²650

Piston tube design for maximum energy absorption

Self-Compensating, Piston Tube Technology

Energy capacity 650 in-lbs/Cycle to 1,860 in-lbs/Cycle

Stroke 0.59 in to 0.91 in

Added safety with accumulator technology: The larger 'soft contact' models from the SC²300 to SC²650 are available with up to three times the energy absorption compared to similar sizes of standard shock absorbers SC190 to SC925, due to the ACE piston tube specialty. Furthermore, the membrane accumulator serves as a compensation element for the oil displaced in the shock absorber and replaces the standard use of absorber materials. This increases process safety even further.

The shock absorbers, which are perfect for rotary actuators for example, are available in progressively stepped effective weight ranges with an integrated positive stop. They are maintenance-free and ready for direct installation. The side load adapter option allows impact angles of up to 25°. They offer soft contact deceleration where initial impact reaction forces are very low, with the advantages of self-compensation to react to changing energy conditions, without adjustment.

These miniature shock absorbers offer high performance levels with a long service life and are particularly popular for material handling, mounting very close to pivots and automation tasks.

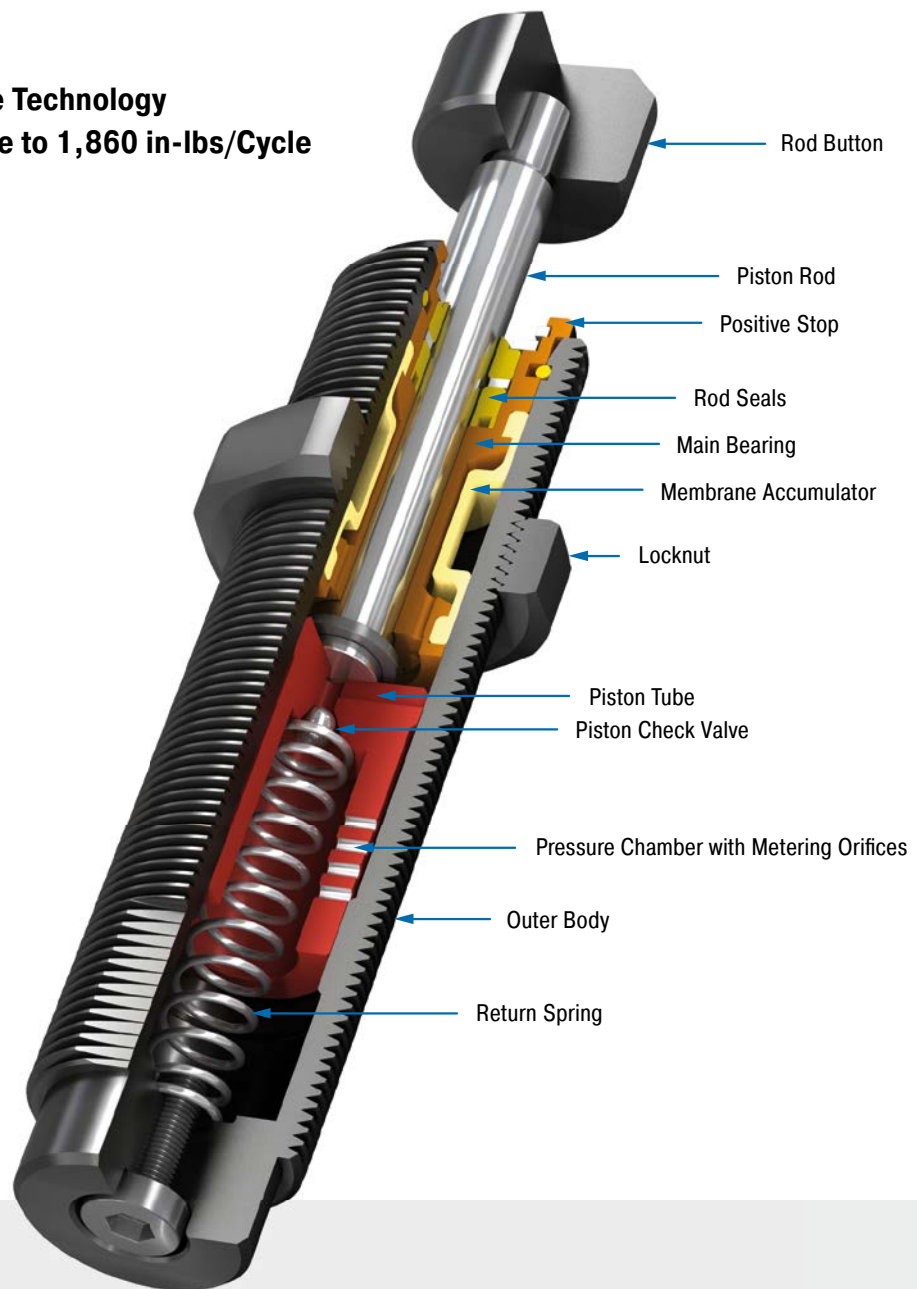

Technical Data

Energy capacity: 650 in-lbs/Cycle to 1,860 in-lbs/Cycle

Impact velocity range: 0.30 ft/sec to 12.0 ft/sec. Other speeds on request.

Operating temperature range: 32 °F to 150 °F

Mounting: In any position

Positive stop: Integrated

Material: Outer body: Steel corrosion-resistant coating; Piston rod: Hardened stainless steel; Accessories: Hardened steel and corrosion-resistant coating

Damping medium: Oil, temperature stable

Application field: Turntables, Swivel units, Robot arms, Linear slides, Pneumatic cylinders, Handling modules, Machines and plants, Finishing and processing centers, Tool machines

Note: If precise end position data is required consider use of a stop collar.

On request: Increased corrosion protection. Special finishes.

SC300; 5 to 9

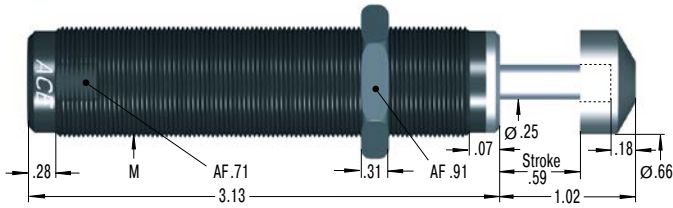

Product available for UNF and metric thread (for metric add suffix -M from part number)

250-0401

Mounting Block

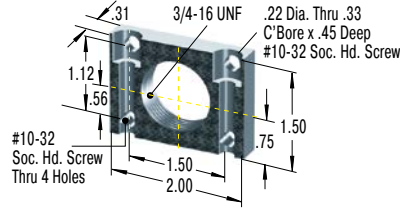

250-0353

Mounting Block

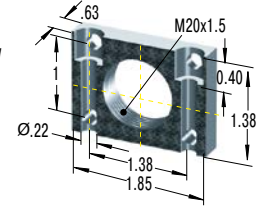

SC650; 5 to 9

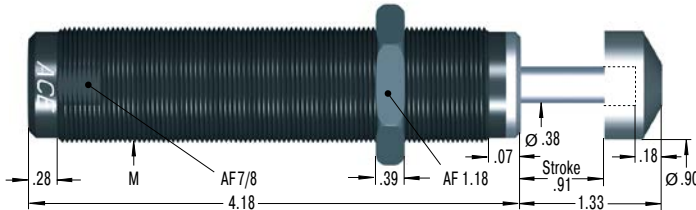

Product available for UNF and metric thread (for metric add suffix -M from part number)

250-0402

Mounting Block

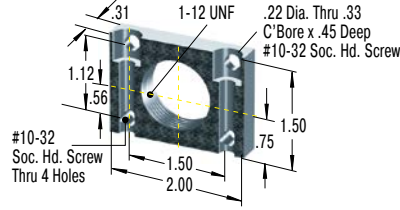

250-0044

Mounting Block

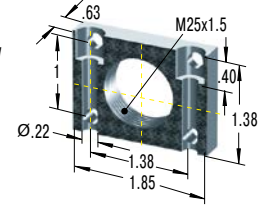

Additional accessories, mounting, installation ... starting on page 40.

Performance

| TYPES | Max. Energy Capacity | | Effective Weight | | | Return Force min. lbs | Return Force max. lbs | Return Time s | 1 Side Load Angle max. ° | M | Weight lbs |
|---------|-----------------------------|-------------------------|------------------|-------------|----------|-----------------------|-----------------------|---------------|--------------------------|----------------------|------------|
| | E ₃ in-lbs/cycle | E ₄ in-lbs/h | We min. lbs | We max. lbs | Hardness | | | | | | |
| SC300-5 | 650 | 400,000 | 25 | 100 | -5 | 1.70 | 4.00 | 0.2 | 5 | 3/4-16 UNF / M20x1.5 | 0.331 |
| SC300-6 | 650 | 400,000 | 75 | 300 | -6 | 1.70 | 4.00 | 0.2 | 5 | 3/4-16 UNF / M20x1.5 | 0.331 |
| SC300-7 | 650 | 400,000 | 200 | 400 | -7 | 1.70 | 4.00 | 0.2 | 5 | 3/4-16 UNF / M20x1.5 | 0.331 |
| SC300-8 | 650 | 400,000 | 300 | 1,500 | -8 | 1.70 | 4.00 | 0.2 | 5 | 3/4-16 UNF / M20x1.5 | 0.331 |
| SC300-9 | 650 | 400,000 | 700 | 4,300 | -9 | 1.70 | 4.00 | 0.2 | 5 | 3/4-16 UNF / M20x1.5 | 0.331 |
| SC650-5 | 1,860 | 600,000 | 50 | 250 | -5 | 2.40 | 7.30 | 0.3 | 5 | 1-12 UNF / M25x1.5 | 0.684 |
| SC650-6 | 1,860 | 600,000 | 200 | 800 | -6 | 2.40 | 7.30 | 0.3 | 5 | 1-12 UNF / M25x1.5 | 0.684 |
| SC650-7 | 1,860 | 600,000 | 700 | 2,400 | -7 | 2.40 | 7.30 | 0.3 | 5 | 1-12 UNF / M25x1.5 | 0.684 |
| SC650-8 | 1,860 | 600,000 | 1,700 | 5,800 | -8 | 2.40 | 7.30 | 0.3 | 5 | 1-12 UNF / M25x1.5 | 0.684 |
| SC650-9 | 1,860 | 600,000 | 4,000 | 14,000 | -9 | 2.40 | 7.30 | 0.3 | 5 | 1-12 UNF / M25x1.5 | 0.684 |

¹ For applications with higher side load angles consider using the side load adaptor, pages 44 to 51.

SC25-HC to SC650-HC

Miniature self compensating shocks for high-speed applications

Self-Compensating

Energy capacity 20 in-lbs/Cycle to 1200 in-lbs/Cycle

Stroke 0.16 in to 0.59 in

ACE Controls SC25-HC to SC650-HC High-Cycle shock absorbers are engineered for high-speed equipment applications. These rugged performers are ideal for the packaging industry. They offer a short stroke, quick time through stroke and quick rod-ready time. In addition, these dependable self-compensating miniatures are capable of rapid repeat strokes. The result is faster cycling for your equipment and gains in production time for you.

Self-compensating shock absorbers react to changing energy conditions, without adjustment.

These miniature, self-compensating shock absorbers provide high-speed performance and reliability in a compact footprint. Applications include: Packaging equipment, slides, rotary actuators, small and medium robotics, machine tools, pick and place operations and more.

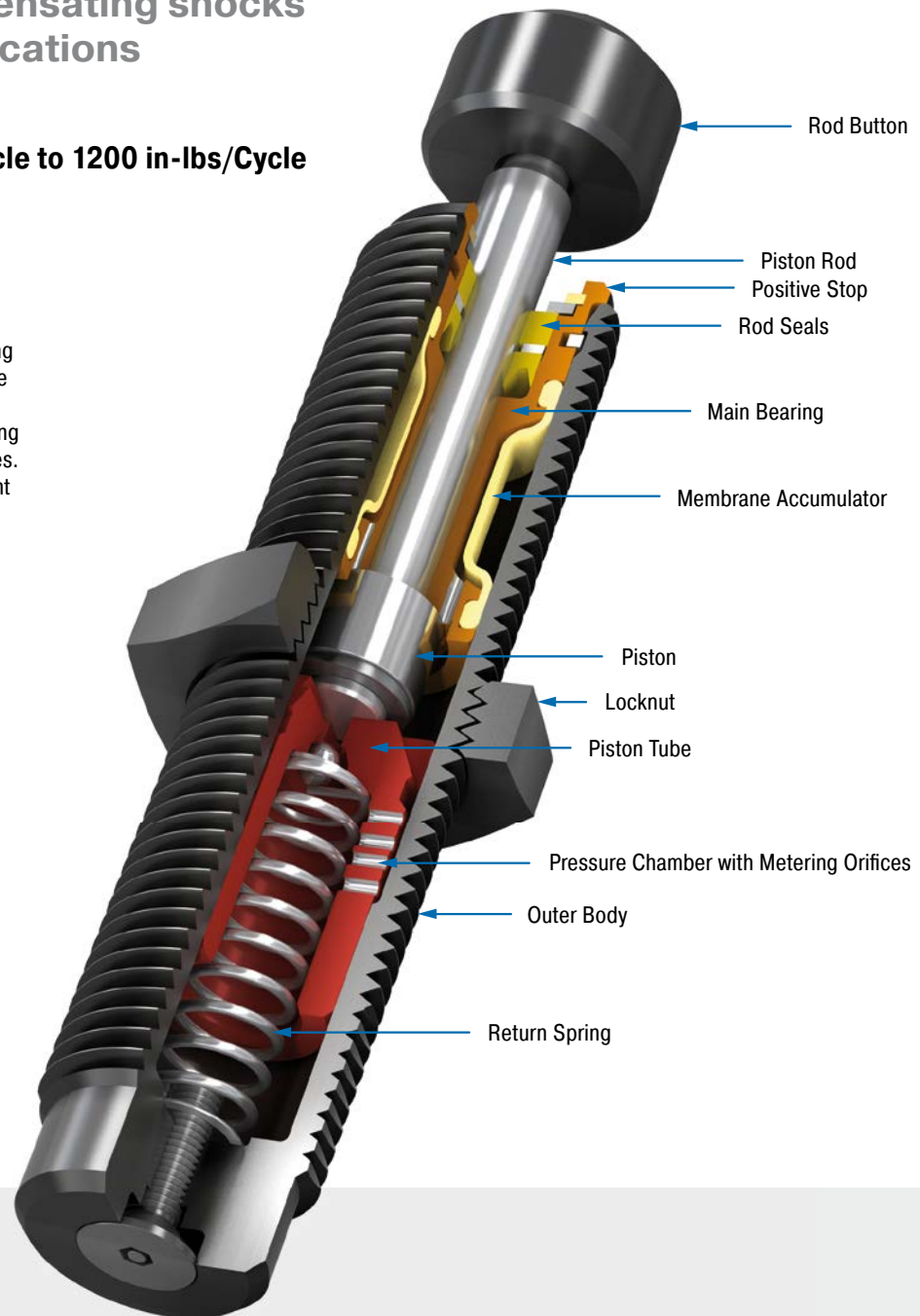

Technical Data

Energy capacity: 20 in-lbs/Cycle to 1200 in-lbs/Cycle

Impact velocity range: 0.09 ft/sec to 14.60 ft/sec

Operating temperature range: 32 °F to 150 °F

Mounting: In any position

Positive stop: Integrated

Material: Outer body: Steel corrosion-resistant coating; Main bearing: Brass; Piston rod: Steel hardened; Locknut, Accessories: Steel; Rolling diaphragm: Rubber (EPDM); Stretch diaphragm: Rubber (nitrile)

Damping medium: SF 96-500 and others

Application field: Linear slides, Tool machines, Handling modules, Production plants

Note: If precise end position is required, consider use of the optional stop collar.

Safety information: External materials in the surrounding area can attack the accumulator and lead to a shorter service life. Please contact ACE for appropriate solution suggestions. Suitable for use in pressure chambers up to 102 psi.

On request: Food grade oils, special threads available on request.

SC25M-HC

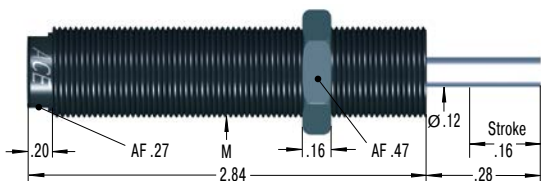

250-0307 Mounting Block

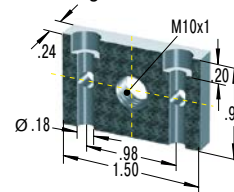

SC75M-HC

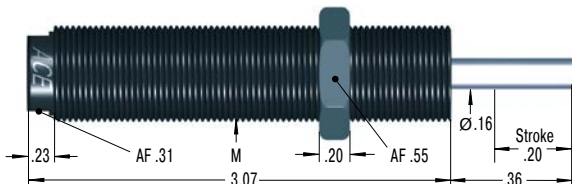

250-0309 Mounting Block

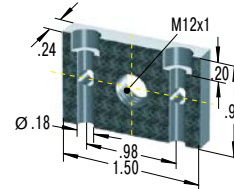

SC190M-HC

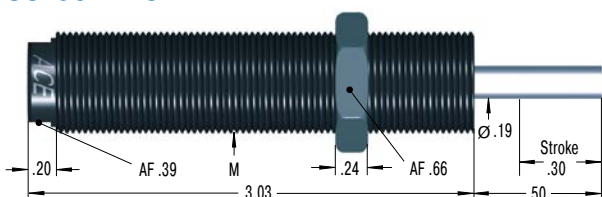

250-0352 Mounting Block

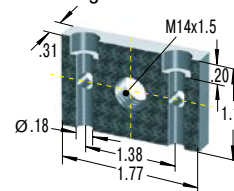

M14x1 also available to special order

SC300-HC

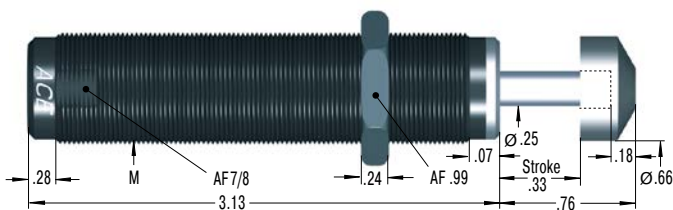

250-0401 Mounting Block

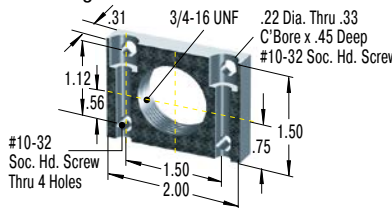

250-0353 Mounting Block

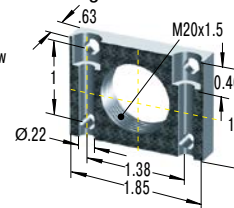

Product available for UNF and metric thread (for metric add suffix -M from part number)

SC650-HC

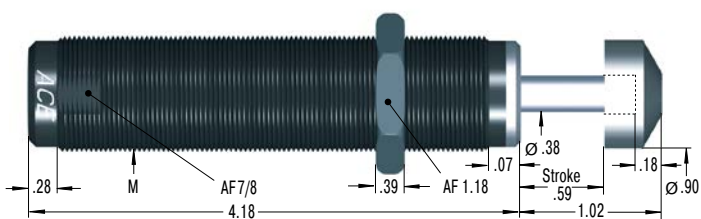

250-0402 Mounting Block

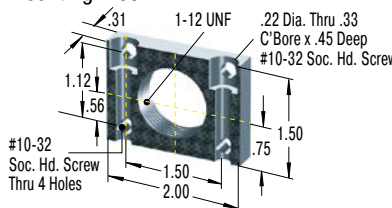

250-0044 Mounting Block

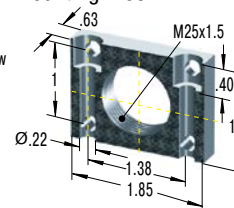

Product available for UNF and metric thread (for metric add suffix -M from part number)

Additional accessories, mounting, installation ... starting on page 40.

Performance

| TYPES | Max. Energy Capacity | | Effective Weight | | Return Force min. lbs | Return Force max. lbs | Return Time s | Side Load Angle max. ° | M | Weight lbs |
|-------------|-----------------------------|--------------------------|------------------|-------------|-----------------------|-----------------------|---------------|------------------------|----------------------|------------|
| | E ₃ in-lbs/cycle | Energy capacity in-lbs/h | We min. lbs | We max. lbs | | | | | | |
| SC25M-5-HC | 20 | 142,000 | 2 | 11 | 1.98 | 3.08 | 0.2 | 2 | M10x1 | 0.066 |
| SC25M-6-HC | 20 | 142,000 | 9 | 97 | 1.98 | 3.08 | 0.2 | 2 | M10x1 | 0.066 |
| SC25M-7-HC | 20 | 142,000 | 93 | 1,100 | 1.98 | 3.08 | 0.2 | 2 | M10x1 | 0.066 |
| SC75M-5-HC | 75 | 266,000 | 2 | 18 | 1.94 | 3.40 | 0.3 | 2 | M12x1 | 0.099 |
| SC75M-6-HC | 75 | 266,000 | 15 | 272 | 1.94 | 3.40 | 0.3 | 2 | M12x1 | 0.099 |
| SC75M-7-HC | 75 | 266,000 | 165 | 1,760 | 1.94 | 3.40 | 0.3 | 2 | M12x1 | 0.099 |
| SC190M-5-HC | 175 | 443,000 | 4 | 35 | 2.67 | 5.57 | 0.3 | 2 | M14x1.5 | 0.130 |
| SC190M-6-HC | 175 | 443,000 | 29 | 309 | 2.67 | 5.57 | 0.3 | 2 | M14x1.5 | 0.130 |
| SC190M-7-HC | 175 | 443,000 | 300 | 3,400 | 2.67 | 5.57 | 0.3 | 2 | M14x1.5 | 0.130 |
| SC300-5-HC | 650 | 400,000 | 25 | 100 | 2.63 | 3.91 | 0.2 | 5 | 3/4-16 UNF / M20x1.5 | 0.362 |
| SC300-6-HC | 650 | 400,000 | 75 | 300 | 2.63 | 3.91 | 0.2 | 5 | 3/4-16 UNF / M20x1.5 | 0.362 |
| SC300-7-HC | 650 | 400,000 | 200 | 400 | 2.63 | 3.91 | 0.2 | 5 | 3/4-16 UNF / M20x1.5 | 0.362 |
| SC300-8-HC | 650 | 400,000 | 300 | 1,500 | 2.63 | 3.91 | 0.2 | 5 | 3/4-16 UNF / M20x1.5 | 0.362 |
| SC300-9-HC | 650 | 400,000 | 700 | 4,300 | 2.63 | 3.91 | 0.2 | 5 | 3/4-16 UNF / M20x1.5 | 0.362 |
| SC650-5-HC | 1,200 | 600,000 | 50 | 250 | 4.94 | 8.30 | 0.2 | 5 | 1-12 UNF / M25x1.5 | 0.695 |
| SC650-6-HC | 1,200 | 600,000 | 200 | 800 | 4.94 | 8.30 | 0.2 | 5 | 1-12 UNF / M25x1.5 | 0.695 |
| SC650-7-HC | 1,200 | 600,000 | 700 | 2,400 | 4.94 | 8.30 | 0.2 | 5 | 1-12 UNF / M25x1.5 | 0.695 |
| SC650-8-HC | 1,200 | 600,000 | 1,700 | 5,800 | 4.94 | 8.30 | 0.2 | 5 | 1-12 UNF / M25x1.5 | 0.695 |
| SC650-9-HC | 1,200 | 600,000 | 4,000 | 14,000 | 4.94 | 8.30 | 0.2 | 5 | 1-12 UNF / M25x1.5 | 0.695 |

¹ For applications with higher side load angles consider using the side load adaptor, pages 44 to 51.

MA30 to MA900

Stepless adjustment

Adjustable

Energy capacity 31 in-lbs/Cycle to 900 in-lbs/Cycle

Stroke 0.28 in to 1.58 in

The miniature shock absorbers from the MA30 to MA900 product family can be adjusted and precisely adapted to your requirements. For example, the MA150 displays the rolling diaphragm technology from the MC150 to MC600 family and offers all of the advantages of this technology, such as use in pressure chambers. Thanks to long strokes (including 1.57 in on the MA900) lower reaction forces result, which provide a soft damping characteristic.

All variations of these units are maintenance-free, ready-to-install machine elements and have an integrated positive stop. They provide the best service where application data changes, where the calculation parameters are not clear or where maximum flexibility in the possible usage is required.

These adjustable miniature shock absorbers from ACE can be used to precisely meet the customer's application needs and are therefore found everywhere in industrial, automation and machine engineering and many other applications.

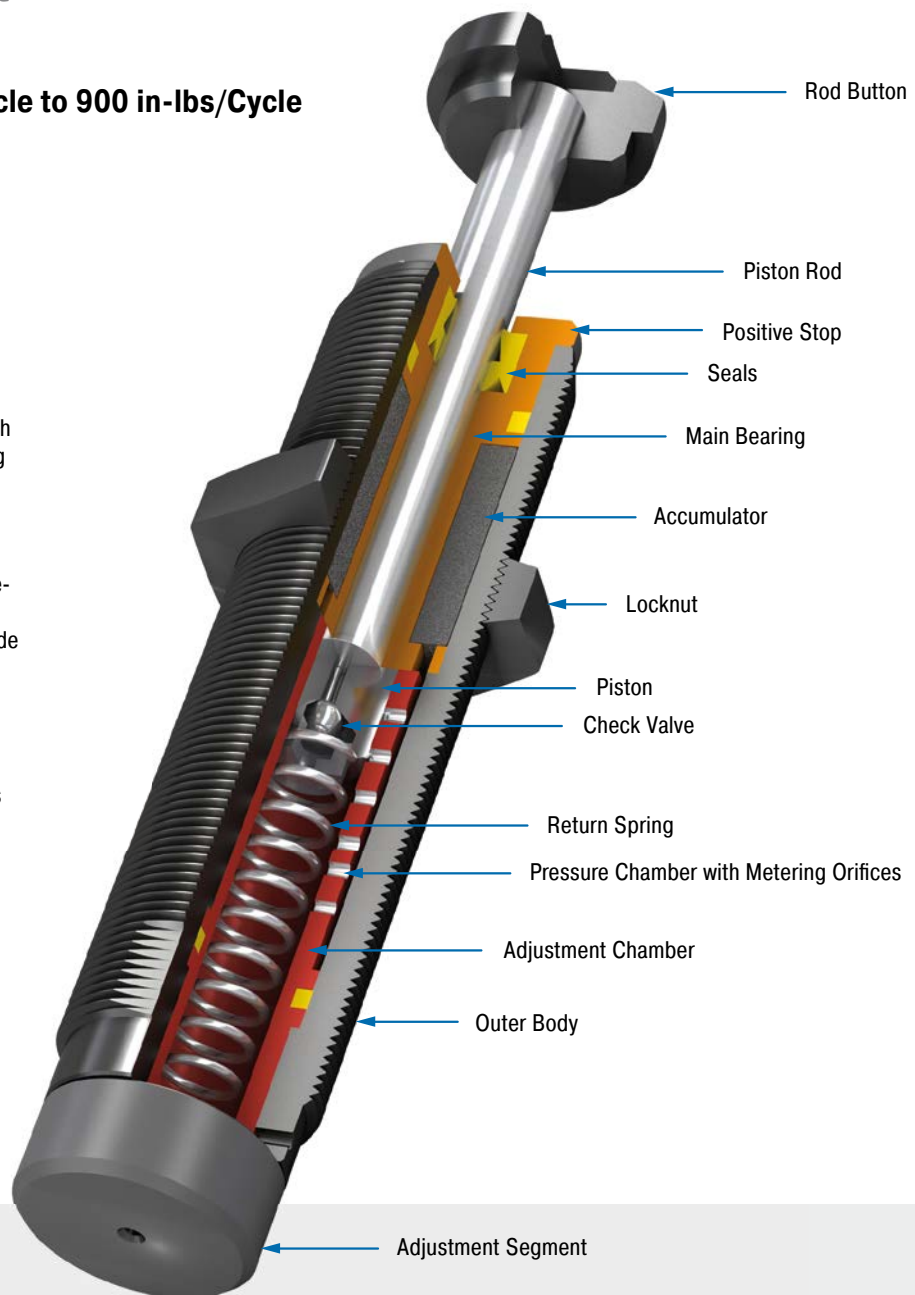

Technical Data

Energy capacity: 31 in-lbs/Cycle to 900 in-lbs/Cycle

Impact velocity range: 0.5 ft/sec to 14.6 ft/sec. Other speeds on request.

Operating temperature range: 32 °F to 150 °F

Mounting: In any position

Positive stop: Integrated

Adjustment: Hard impact at the start of stroke, adjust the ring towards 9 or PLUS. Hard impact at the end of stroke, adjust the ring towards 0 or MINUS.

Material: Outer body, Accessories: Steel corrosion-resistant coating; Piston rod: Hardened stainless steel

Damping medium: Oil, temperature stable

Application field: Linear slides, Pneumatic cylinders, Swivel units, Handling modules, Machines and plants, Finishing and processing centers, Automatic machinery, Tool machines, Locking systems

Note: If precise end position data is required consider use of a stop collar. Shock absorber is preset at delivery in a neutral position between hard and soft.

Safety information: External materials in the surrounding area can attack the seal components and lead to a shorter service life. Please contact ACE for appropriate solution suggestions. Do not paint the shock absorbers due to heat emission.

On request: Nickel-plated or other special options available to special order. Models without rod end button.



MA30M

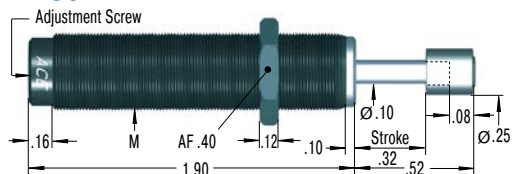

MA50M

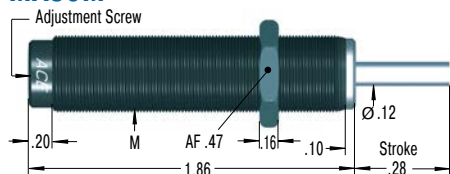

MA35

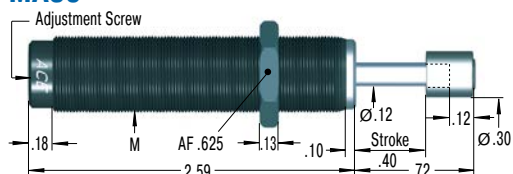

Product available for UNF and metric thread (for metric add suffix -M from part number)

MA150

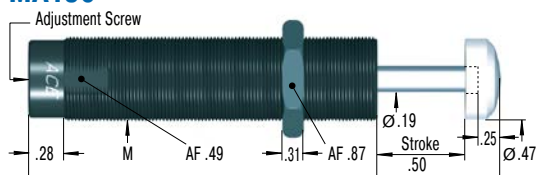

Product available for UNF and metric thread (for metric add suffix -M from part number) M14x1 also available to special order. Standard shock does not include button.

MA225

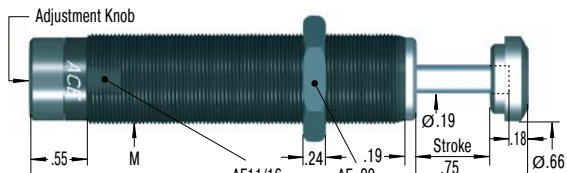

Product available for UNF and metric thread (for metric add suffix -M from part number)

MA600

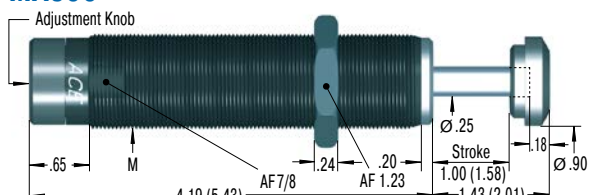

Product available for UNF and metric thread (for metric add suffix -M from part number) Dimensions for MA900M in ().

250-0307

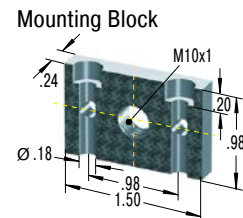

250-0308

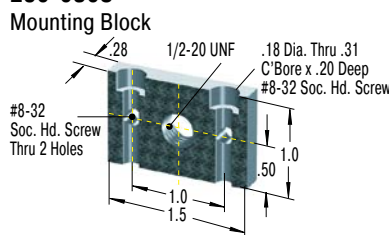

250-0309

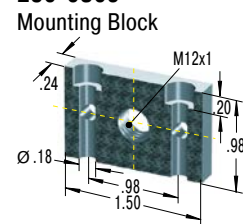

250-0318

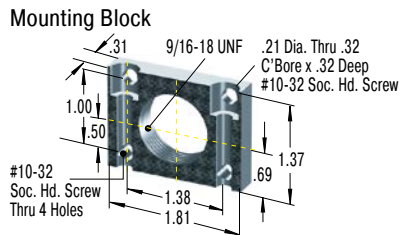

250-0352

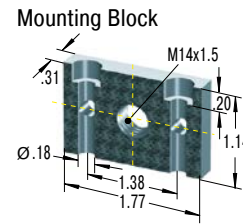

250-0401

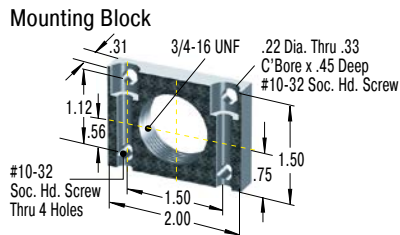

250-0353

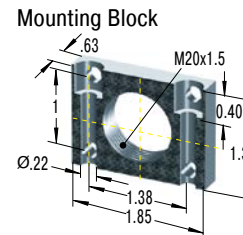

250-0402

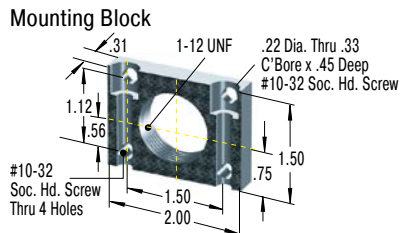

250-0044

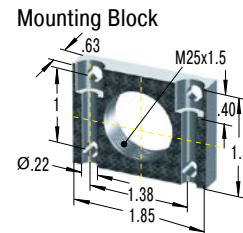

Additional accessories, mounting, installation ... starting on page 40.

Performance

| TYPES | Max. Energy Capacity | | Effective Weight | | Return Force min. lbs | Return Force max. lbs | Return Time s | Side Load Angle max. ° | M | Weight lbs |
|-------|-----------------------------|-------------------------|------------------|-------------|-----------------------|-----------------------|---------------|------------------------|-----------------------|------------|
| | E ₃ in-lbs/cycle | E ₄ in-lbs/h | We min. lbs | We max. lbs | | | | | | |
| MA30M | 31 | 50,000 | 0.5 | 31 | 1.16 | 1.57 | 0.3 | 2 | M8x1 | 0.029 |
| MA50M | 50 | 120,000 | 10 | 45 | 0.47 | 1.80 | 0.3 | 2 | M10x1 | 0.055 |
| MA35 | 35 | 53,000 | 13 | 125 | 1.20 | 2.60 | 0.2 | 2 | 1/2-20 UNF / M12x1 | 0.095 |
| MA150 | 200 | 300,000 | 2 | 240 | 0.70 | 1.20 | 0.4 | 2 | 9/16-18 UNF / M14x1.5 | 0.135 |
| MA225 | 300 | 400,000 | 5 | 500 | 1.05 | 2.15 | 0.1 | 2 | 3/4-16 UNF / M20x1.5 | 0.381 |
| MA600 | 600 | 600,000 | 20 | 3,000 | 2.40 | 6.87 | 0.2 | 2 | 1-12 UNF / M25x1.5 | 0.776 |
| MA900 | 900 | 800,000 | 30 | 4,500 | 2.40 | 7.40 | 0.4 | 1 | 1-12 UNF / M25x1.5 | 0.913 |

¹ For applications with higher side load angles consider using the side load adaptor, pages 44 to 51.

3/8x1

Miniature adjustable shock delivers convenience

Adjustable

Energy capacity 600 in-lbs/Cycle

Stroke 1 in

ACE Controls 3/8x1" bore adjustable miniature shock absorber offers high energy capacity and a wide effective weight range for handling a variety of applications. A unique feature of the multi-orifice 3/8x1" bore is the optional rear slot adjuster. Adjustment can be made by turning the front adjuster to the preferred setting, or by turning the rear slot adjuster if desired.

Available with side or rear adjustment, these 1" bore shock absorbers provide performance and convenience in one reliable package. Applications include: Slides, material handling equipment, robotics, machine tools, pick and place systems, packaging equipment and more.

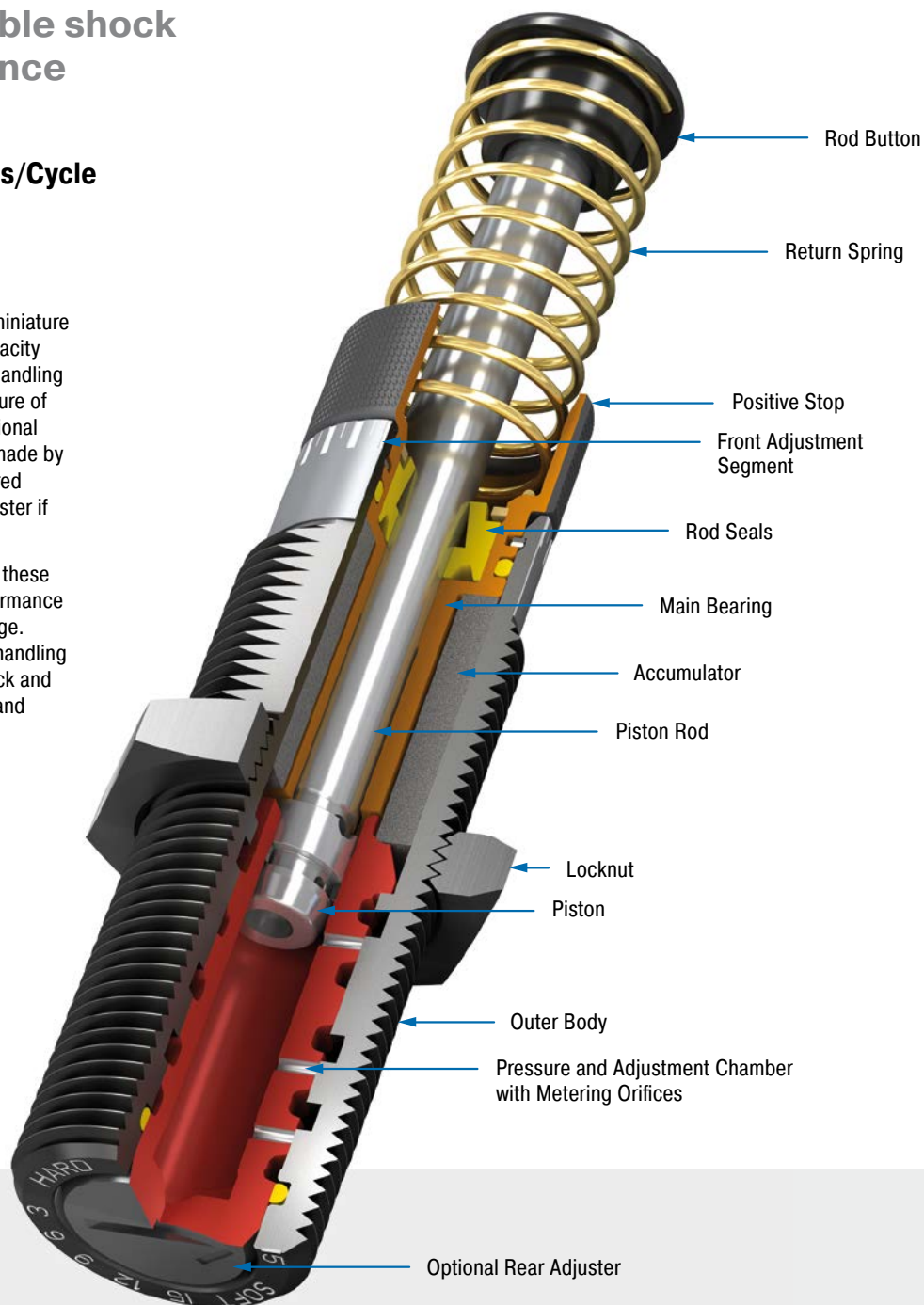

Technical Data

Energy capacity: 600 in-lbs/Cycle

Impact velocity range: 1.6 ft/sec to 15 ft/sec

Operating temperature range: 10 °F to 150 °F

Mounting: In any position. Clevis mounting available (NA 3/8x1)

Adjustment: Adjustment can be made by turning the front adjuster to the preferred setting, or by turning the rear slot adjuster if desired.

Material: Outer body, Accessories: Steel corrosion-resistant coating; Main bearing, Rod end button: Steel hardened; Piston rod: Steel hardened and chrome plated; Return spring: Steel; Locknut: Zinc plated steel

Damping medium: American 46

Application field: Linear slides, Transport industry, Tool machines, Handling modules, Production plants

Note: Maximum side load depends on application. For additional information contact ACE Controls' Applications Department. Lock nut included with each shock absorber.

Safety information: External materials in the surrounding area can attack the seal components and lead to a shorter service life. Please contact ACE for appropriate solution suggestions. Do not paint the shock absorbers due to heat emission.

On request: Increased corrosion protection. Special finishes. Models without rod end button also available on request.

AS3/8x1

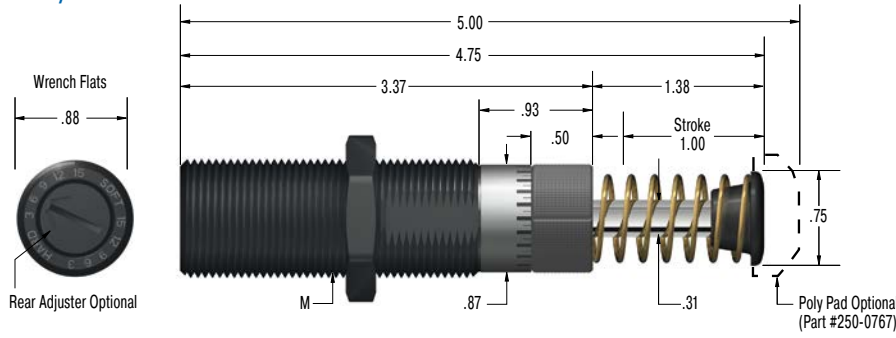

250-0402

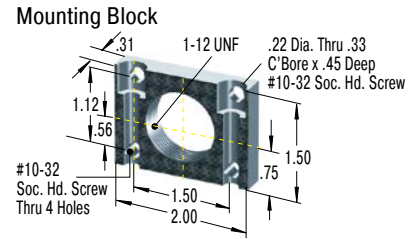

NA3/8x1

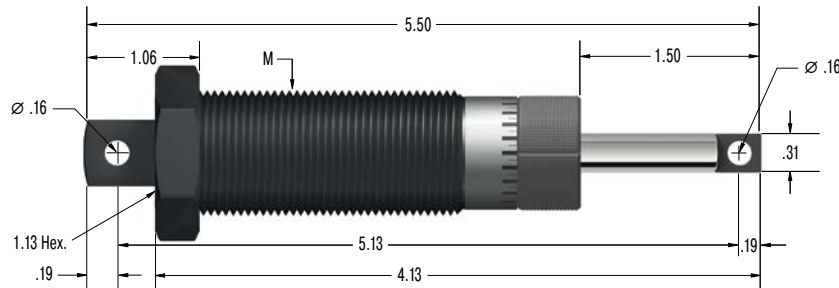

250-0402

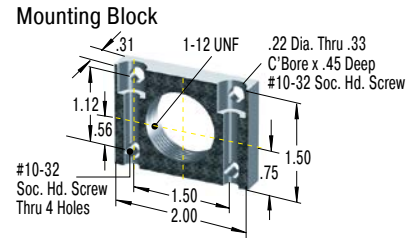

Accessories, mounting, installation ... starting on page 40.

Issue 04.2018 – Specifications subject to change

Performance

| TYPES | Max. Energy Capacity | | Effective Weight | | Return Force min. lbs | Return Force max. lbs | Return Time s | ¹ Side Load Angle max. ° | M | Weight lbs |
|---------|-----------------------------|--------------------------|------------------|-------------|-----------------------|-----------------------|---------------|--------------------------|----------|------------|
| | E ₃ in-lbs/cycle | Energy capacity in-lbs/h | We min. lbs | We max. lbs | | | | | | |
| AS3/8x1 | 600 | 600,000 | 10 | 1,250 | 6 | 11 | 0.03 | 5 | 1-12 UNF | 0.437 |
| NA3/8x1 | 600 | 600,000 | 10 | 1,250 | 6 | 11 | 0.03 | 5 | N/A | 0.437 |

¹ For applications with higher side load angles consider using the side load adaptor, pages 44 to 51.

Selection Chart



| Shock Absorber Type | ¹ Locknut | ² Stop Collar | Mounting Block | ³ Side Load Adaptor |
|-----------------------|----------------------|--------------------------|----------------|--------------------------------|
| Thread M5x0.5 | | | | |
| MC5M | 0801-001 | – | – | – |
| Thread M6x0.5 | | | | |
| MC9M | 250-0716 | – | – | – |
| Thread M8x1 | | | | |
| MA30M | 250-0482 | – | – | 250-0146 |
| MC10M | 250-0482 | – | – | 250-0141 |
| MC30M | 250-0482 | – | – | 250-0146 |
| Thread M10x1 | | | | |
| MA50M | 250-0315 | 250-0408 | 250-0307 | 250-0562 |
| MC25M | 250-0315 | 250-0408 | 250-0307 | 250-0562 |
| SC25M; 5 to 7 | 250-0315 | 250-0408 | 250-0307 | – |
| SC25M-HC | 250-0315 | 250-0408 | 250-0307 | – |
| Thread M12x1 | | | | |
| MA35M | 250-0317 | 250-0409 | 250-0309 | 250-0760 |
| MC75M | 250-0317 | 250-0409 | 250-0309 | 250-0760 |
| SC75M; 5 to 7 | 250-0317 | 250-0409 | 250-0309 | 250-0145 |
| SC75M-HC | 250-0317 | 250-0409 | 250-0309 | – |
| Thread M14x1.5 | | | | |
| MA150M | 250-0233 | 250-0272 | 250-0352 | 250-0558 |
| MC150M | 250-0233 | 250-0272 | 250-0352 | 250-0558 |
| MC150M-V4A | 250-0441 | 250-0243 | 250-0255 | – |
| PMCN150M | 250-0233 | – | 250-0352 | – |
| PMCN150M-V4A | 250-0441 | – | 250-0255 | – |
| SC190M; 0 to 4 | 250-0233 | 250-0272 | 250-0352 | 250-0080 |
| SC190M; 5 to 7 | 250-0233 | 250-0272 | 250-0352 | 250-0558 |
| SC190M-HC | 250-0233 | 250-0272 | 250-0352 | – |
| Thread M20x1.5 | | | | |
| MA225M | 250-0207 | 250-0410 | 250-0353 | 250-0081 |
| MC225M | 250-0207 | 250-0410 | 250-0353 | 250-0559 |
| MC225M-V4A | 250-0442 | 250-0253 | 250-0434 | – |
| PMCN225M | 250-0207 | – | 250-0353 | – |
| PMCN225M-V4A | 250-0442 | – | 250-0434 | – |
| SC300M; 0 to 4 | 250-0207 | 250-0410 | 250-0353 | 250-0081 |
| SC300M; 5 to 9 | 250-0207 | 250-0410 | 250-0353 | – |
| SC300M-HC | 250-0207 | 250-0410 | 250-0353 | – |
| Thread M25x1.5 | | | | |
| AS3/8x1M | 250-0040 | 250-0766 | 250-0044 | – |
| MA600M | 250-0040 | 250-0276 | 250-0044 | 250-0082 |
| MA900M | 250-0040 | 250-0276 | 250-0044 | 250-0082 |
| MC600M | 250-0040 | 250-0276 | 250-0044 | 250-0560 |
| MC600M-V4A | 250-0443 | 250-0254 | 250-0436 | – |
| PMCN600M | 250-0040 | – | 250-0044 | – |
| PMCN600M-V4A | 250-0443 | – | 250-0436 | – |
| SC650M; 0 to 4 | 250-0040 | 250-0276 | 250-0044 | 250-0082 |
| SC650M; 5 to 9 | 250-0040 | 250-0276 | 250-0044 | – |
| SC650M-HC | 250-0040 | 250-0276 | 250-0044 | – |
| SC925M; 0 to 4 | 250-0040 | 250-0276 | 250-0044 | – |

¹ Additional special options: Locknut 205-0362 for the MC10ME (extra fine thread), locknut 250-0232 for the MA/MC150E (extra fine thread), locknut 250-0239 for the MC600ML (extra fine thread).

² Additional special options: Stop Collar 250-0263 for the MC600ML (extra fine thread).

³ Only mountable on units without button. Remove the button from the shock absorber, if there's one fitted!

The following side load adaptors fit -880 model shock absorbers: 250-0080, -0081, -0082, -0141, -0145, -0562, -0760, -0762 and -0763.

Dimensions can be found on the corresponding accessories pages.



Steel Shroud

Steel Button

Steel/Urethane Button

Nylon Button

Page

| Thread | Steel Shroud | Steel Button | Steel/Urethane Button | Nylon Button | Page |
|----------------|--------------|--------------|-----------------------|--------------|------|
| Thread M5x0.5 | - | - | - | - | 44 |
| Thread M6x0.5 | - | - | - | - | 44 |
| Thread M8x1 | 250-0832 | - | 250-0764 | - | 44 |
| | 250-0833 | - | - | - | 44 |
| | 250-0832 | - | 250-0764 | - | 44 |
| Thread M10x1 | 250-0834 | 250-0124 | - | - | 44 |
| | 250-0834 | 250-0124 | 250-0094 | - | 44 |
| | 250-0835 | 250-0175 | - | - | 44 |
| | 250-0835 | 250-0175 | - | - | 44 |
| Thread M12x1 | 250-0836 | 250-0786 | 250-0094 | - | 45 |
| | 250-0836 | 250-0786 | 250-0094 | - | 45 |
| | 250-0837 | 250-0174 | - | - | 45 |
| | 250-0837 | 250-0174 | - | - | 45 |
| Thread M14x1.5 | 250-0733 | 250-0111 | 250-0095 | - | 45 |
| | 250-0733 | 250-0111 | 250-0095 | 250-0753 | 45 |
| | - | - | - | 250-0753 | 45 |
| | - | - | - | - | 45 |
| | - | - | - | - | 45 |
| | 250-0785 | included | 250-0096 | - | 45 |
| | 250-0733 | 250-0111 | 250-0095 | - | 45 |
| | 250-0733 | 250-0111 | 250-0095 | - | 45 |
| Thread M20x1.5 | 250-0734 | included | 250-0098 | - | 46 |
| | 250-0170 | 250-0112 | 250-0097 | 250-0754 | 46 |
| | - | - | - | 250-0754 | 46 |
| | - | - | - | - | 46 |
| | - | - | - | - | 46 |
| | 250-0734 | included | 250-0098 | - | 46 |
| | 250-0734 | included | 250-0105 | - | 46 |
| | 250-0734 | included | 250-0105 | - | 46 |
| Thread M25x1.5 | - | - | 250-0099 | - | 47 |
| | 250-0765 | included | 250-0100 | - | 47 |
| | 250-0765 | included | 250-0100 | - | 47 |
| | 250-0171 | 10721-000 | 250-0099 | 250-0755 | 47 |
| | - | - | - | 250-0755 | 47 |
| | - | - | - | - | 47 |
| | - | - | - | - | 47 |
| | 250-0765 | included | 250-0100 | - | 47 |
| | 250-0171 | included | 250-0099 | - | 47 |
| | 250-0171 | included | 250-0099 | - | 47 |
| | - | included | 250-0100 | - | 47 |

Issue 04.2018 – Specifications subject to change

Selection Chart



| Shock Absorber Type | Locknut | Stop Collar | Mounting Block | ¹ Side Load Adaptor |
|---------------------------|----------|-------------|----------------|--------------------------------|
| Thread 3/8-32 UNF | | | | |
| MC25 | 250-0404 | 250-0406 | 250-0306 | – |
| Thread 1/2-20 UNF | | | | |
| MA35 | 250-0405 | 250-0407 | 250-0308 | – |
| MC75 | 250-0405 | 250-0407 | 250-0308 | 250-0762 |
| Thread 9/16-18 UNF | | | | |
| MA150 | 250-0231 | 250-0271 | 250-0318 | 250-0554 |
| MC150 | 250-0231 | 250-0271 | 250-0318 | 250-0554 |
| SC190; 0 to 4 | 250-0231 | 250-0271 | 250-0318 | – |
| Thread 3/4-16 UNF | | | | |
| MA225 | 250-0399 | 250-0403 | 250-0401 | 250-0561 |
| MC225 | 250-0399 | 250-0403 | 250-0401 | 250-0561 |
| SC300; 0 to 4 | 250-0399 | 250-0403 | 250-0401 | – |
| SC300; 5 to 9 | 250-0399 | 250-0403 | 250-0401 | – |
| SC300-HC | 250-0399 | 250-0403 | 250-0401 | – |
| Thread 1-12 UNF | | | | |
| AS3/8x1 | 250-0400 | 250-0774 | 250-0402 | – |
| MA600 | 250-0400 | 250-0275 | 250-0402 | – |
| MA900 | 250-0400 | 250-0275 | 250-0402 | – |
| MC600 | 250-0400 | 250-0275 | 250-0402 | 250-0763 |
| NA3/8x1 | 250-0400 | 250-0774 | 250-0402 | – |
| SC650; 0 to 4 | 250-0400 | 250-0275 | 250-0402 | – |
| SC650; 5 to 9 | 250-0400 | 250-0275 | 250-0402 | – |
| SC650-HC | 0801-041 | 250-0275 | 250-0402 | – |
| SC925; 0 to 4 | 250-0400 | 250-0275 | 250-0402 | – |

¹ Only mountable on units without button. Remove the button from the shock absorber, if there's one fitted!

The following side load adaptors fit -880 model shock absorbers: 250 -0080, -0081, -0082, -0141, -0145, -0562, -0760, -0762 and -0763.

Dimensions can be found on the corresponding accessories pages.



Steel Shroud

Steel Button

Steel/Urethane Button

Nylon Button

Page

| Thread | Steel Shroud | Steel Button | Steel/Urethane Button | Nylon Button | Page |
|--------------------|--------------|--------------|-----------------------|--------------|------|
| Thread 3/8-32 UNF | 250-0834 | 250-0124 | 250-0094 | – | 48 |
| | – | – | – | – | – |
| Thread 1/2-20 UNF | – | 250-0786 | 250-0094 | – | 48 |
| | 250-0836 | 250-0786 | 250-0094 | – | 48 |
| Thread 9/16-18 UNF | 250-0733 | 250-0111 | 250-0095 | – | 48 |
| | 250-0785 | 250-0111 | 250-0095 | 250-0753 | 48 |
| | 250-0733 | included | 250-0096 | – | 48 |
| | – | – | – | – | – |
| Thread 3/4-16 UNF | 250-0734 | included | 250-0098 | – | 49 |
| | 250-0170 | 250-0112 | 250-0097 | 250-0754 | 49 |
| | 250-0734 | included | 250-0098 | – | 49 |
| | 250-0734 | included | 250-0105 | – | 49 |
| | 250-0734 | included | 250-0105 | – | 49 |
| Thread 1-12 UNF | – | included | 250-0099 | – | 49 |
| | 250-0765 | included | 250-0100 | – | 49 |
| | – | included | 250-0100 | – | 49 |
| | 250-0171 | 10721-000 | 250-0099 | 250-0755 | 49 |
| | – | included | 250-0099 | – | 49 |
| | 250-0765 | included | 250-0100 | – | 49 |
| | 250-0171 | included | 250-0099 | – | 49 |
| | 250-0171 | included | 250-0099 | – | 49 |
| | – | included | 250-0100 | – | 49 |

Selection Chart See Pages 40 to 41

M5x0.5

0801-001
Locknut

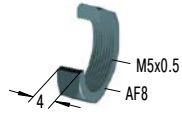

M6x0.5

250-0716
Locknut

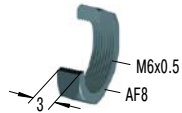

M8x1

250-0482
Locknut

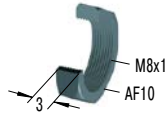

250-0362
Locknut

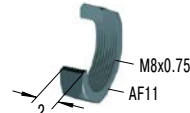

250-0141
Side Load Adaptor

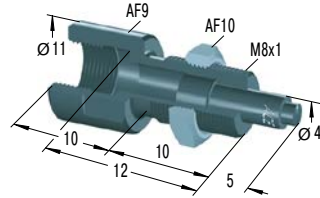

250-0146
Side Load Adaptor

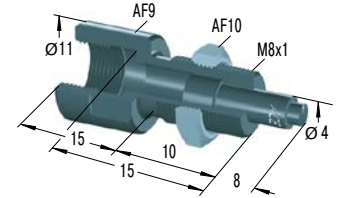

250-0832
Steel Shroud

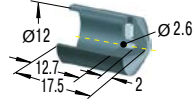

250-0833
Steel Shroud

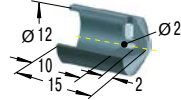

250-0764
Steel/Urethane Button

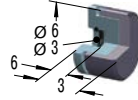

M10x1

250-0315
Locknut

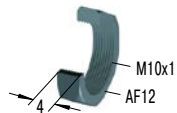

250-0408
Stop Collar

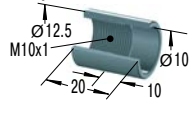

250-0307
Mounting Block

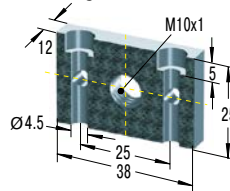

250-0562
Side Load Adaptor

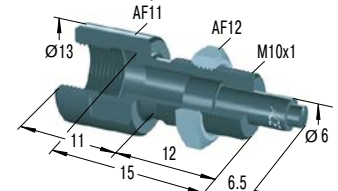

250-0834
Steel Shroud

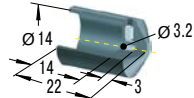

250-0835
Steel Shroud

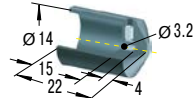

250-0124
Steel Button

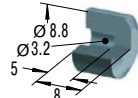

250-0175
Steel Button

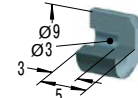

250-0094
Steel/Urethane Button

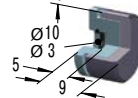

Mounting, installation, ... see pages 50 to 51.

M12x1

250-0317
Locknut

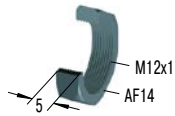

250-0409
Stop Collar

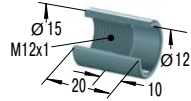

250-0309
Mounting Block

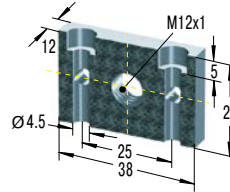

250-0145
Side Load Adaptor

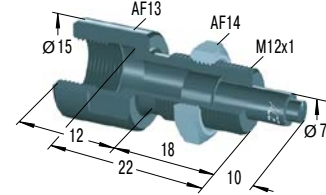

250-0760
Side Load Adaptor

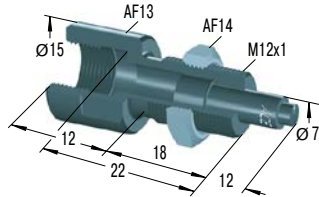

250-0836
Steel Shroud

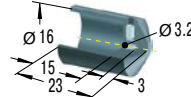

250-0837
Steel Shroud

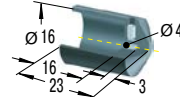

250-0174
Steel Button

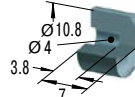

250-0786
Steel Button

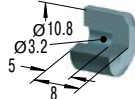

250-0094
Steel/Urethane Button

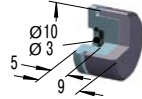

M14x1

250-0232
Locknut

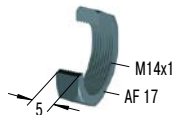

250-0233
Locknut

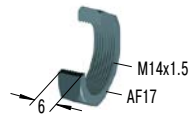

250-0441
Locknut

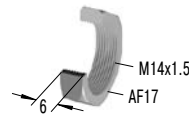

250-0243
Stop Collar

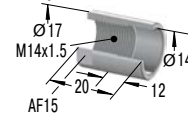

250-0272
Stop Collar

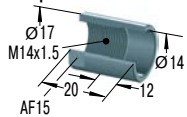

250-0255
Mounting Block

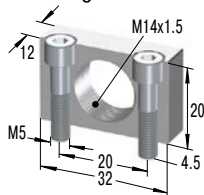

250-0352
Mounting Block

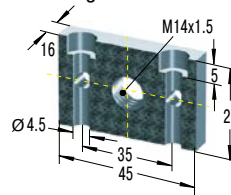

250-0080
Side Load Adaptor

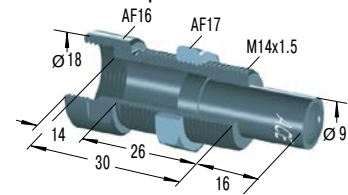

250-0558
Side Load Adaptor

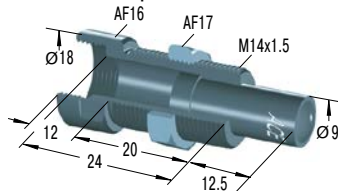

250-0733
Steel Shroud

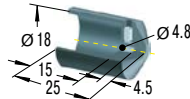

250-0785
Steel Shroud

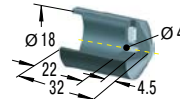

250-0111
Steel Button

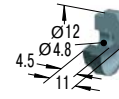

250-0095
Steel/Urethane Button

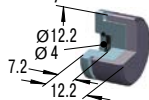

250-0096
Steel/Urethane Button

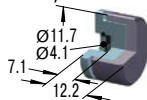

250-0753
Nylon Button

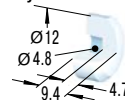

E_s max = 14 Nm

Selection Chart See Pages 40 to 41

M20x1.5

250-0207
Locknut

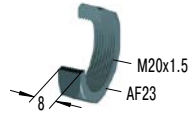

250-0442
Locknut



250-0253
Stop Collar

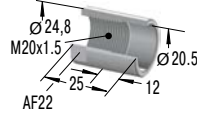

250-0410
Stop Collar

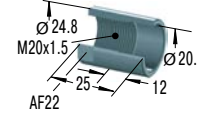

250-0353
Mounting Block

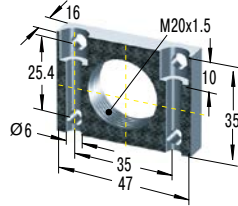

250-0434
Mounting Block

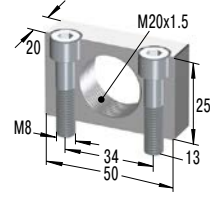

250-0081
Side Load Adaptor

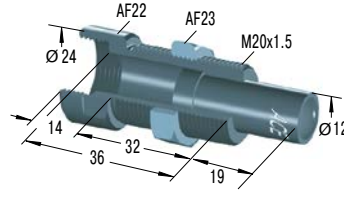

250-0559
Side Load Adaptor

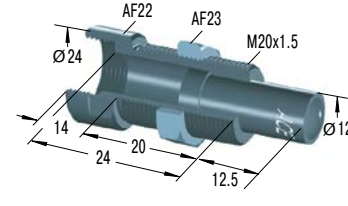

250-0170
Steel Shroud

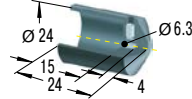

250-0734
Steel Shroud

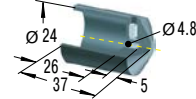

250-0112
Steel Button

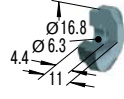

250-0097
Steel/Urethane Button

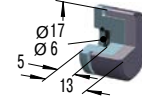

250-0098
Steel/Urethane Button

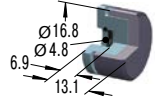

250-0105
Steel/Urethane Button

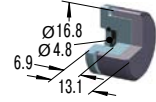

250-0754
Nylon Button

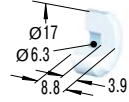

$E_3 \text{ max} = 33 \text{ Nm}$

Mounting, installation, ... see pages 50 to 51.

M25x1.5

250-0040
Locknut

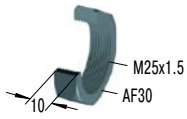

250-0443
Locknut

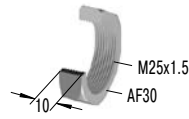

250-0254
Stop Collar

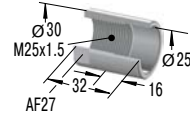

250-0263
Stop Collar

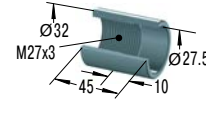

250-0276
Stop Collar

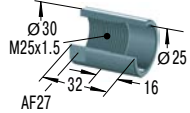

250-0766
Stop Collar

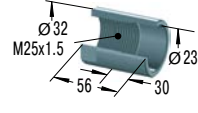

250-0044
Mounting Block

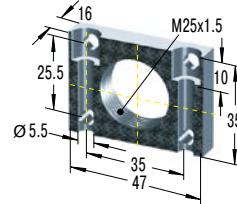

250-0436
Mounting Block

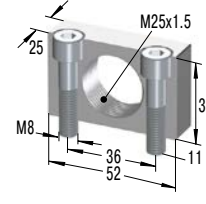

250-0082
Side Load Adaptor

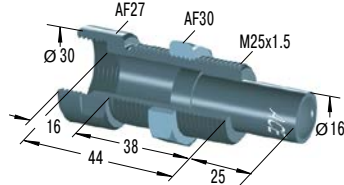

250-0560
Side Load Adaptor

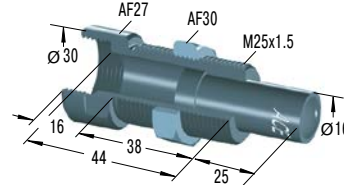

250-0171
Steel Shroud

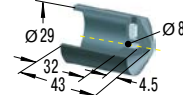

250-0765
Steel Shroud

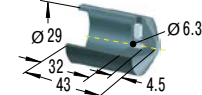

10721-000
Steel Button

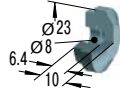

250-0099
Steel/Urethane Button

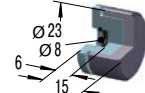

250-0100
Steel/Urethane Button

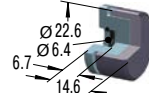

250-0755
Nylon Button

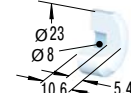

E_s max = 68 Nm

Selection Chart See Pages 42 to 43

3/8-32 UNF

250-0404
Locknut



250-0406
Stop Collar

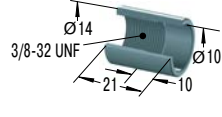

250-0306
Mounting Block

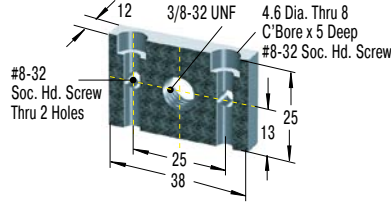

250-0834
Steel Shroud

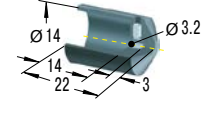

250-0124
Steel Button

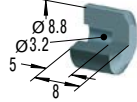

250-0094
Steel/Urethane Button

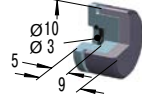

1/2-20 UNF

250-0405
Locknut

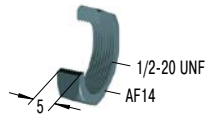

250-0407
Stop Collar

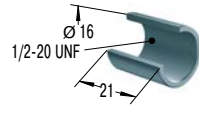

250-0308
Mounting Block

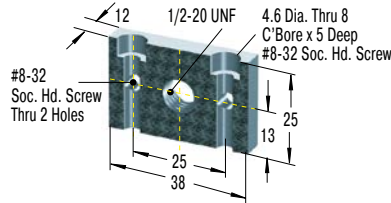

250-0762
Side Load Adaptor

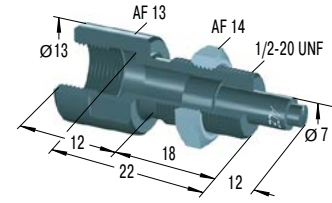

250-0786
Steel Button

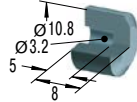

250-0094
Steel/Urethane Button

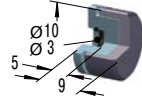

9/16-18 UNF

250-0231
Locknut



250-0271
Stop Collar

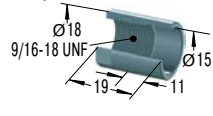

250-0318
Mounting Block

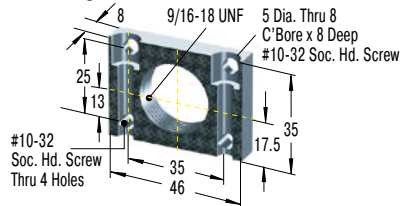

250-0554
Side Load Adaptor

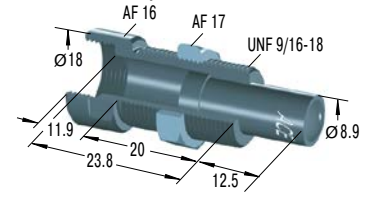

250-0733
Steel Shroud

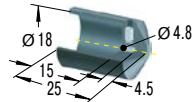

250-0785
Steel Shroud

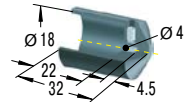

250-0111
Steel Button

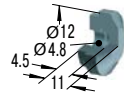

250-0095
Steel/Urethane Button

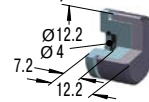

250-0096
Steel/Urethane Button

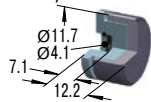

250-0753
Nylon Button

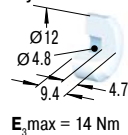

Mounting, installation, ... see pages 50 to 51.

3/4-16 UNF

250-0399
Locknut



250-0403
Stop Collar

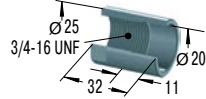

250-0401
Mounting Block

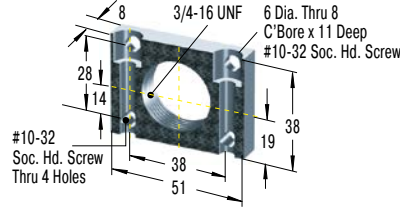

250-0561
Side Load Adaptor

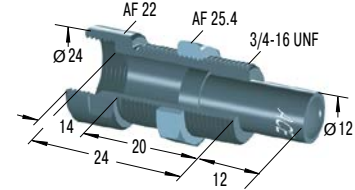

250-0170
Steel Shroud

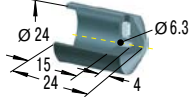

250-0734
Steel Shroud

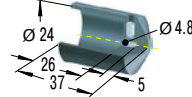

250-0112
Steel Button

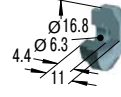

250-0097
Steel/Urethane Button

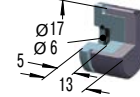

250-0098
Steel/Urethane Button

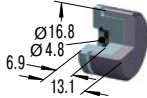

250-0105
Steel/Urethane Button

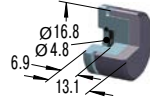

250-0754
Nylon Button

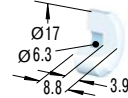

$E_3 \text{ max} = 33 \text{ Nm}$

1-12 UNF

0801-041
Locknut

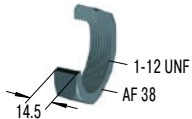

250-0400
Locknut

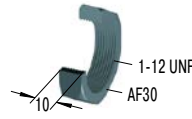

250-0275
Stop Collar

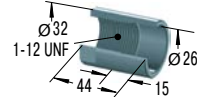

250-0774
Stop Collar

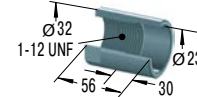

250-0402
Mounting Block

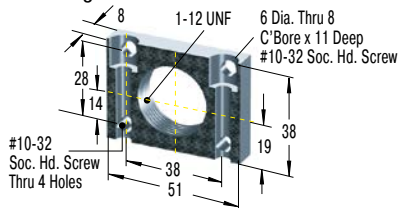

250-0763
Side Load Adaptor

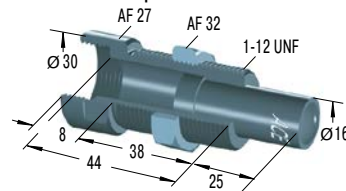

250-0171
Steel Shroud

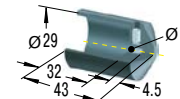

250-0765
Steel Shroud

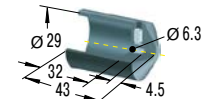

10721-000
Steel Button

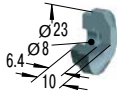

250-0099
Steel/Urethane Button

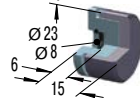

250-0100
Steel/Urethane Button

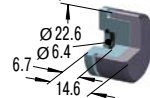

250-0755
Nylon Button

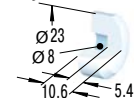

$E_3 \text{ max} = 68 \text{ Nm}$

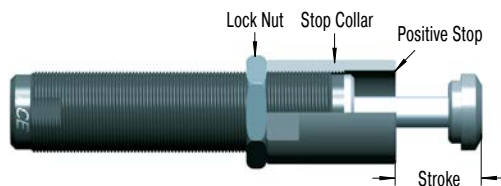

Stop Collar

All ACE miniature shock absorbers have an integrated positive stop. An optional stop collar can be added if desired to give fine adjustment of final stopping position.

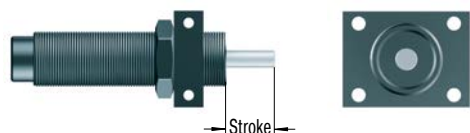

Mounting Block

This versatile block can be mounted to a horizontal or vertical surface. The shock is screwed into the center threaded hole and secured with a locknut.

Mounting information

Mounting block only. Bolts supplied separately.

Delivery

One locknut is included with each shock.

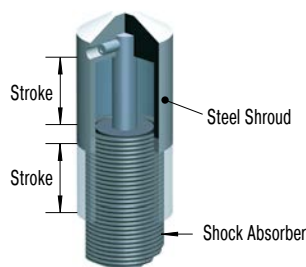

Steel Shroud

Grinding beads, sand, welding splatter, paints, adhesives, etc. can adhere to the piston rod. They then damage the rod seals and the shock absorber quickly fails. In many cases the installation of the optional steel shroud can provide worthwhile protection and increase lifetime.

Ordering information

The steel shroud can only be installed onto a shock absorber without rod end button.

For part number MA, MC, SC please order with "-880" suffix. Part numbers MA150, MC150 to MC600 and SC25 to SC190 5-7 are supplied without a button.

Safety information

When installing don't forget to allow operating space for the shroud to move as the shock absorber is cycled.

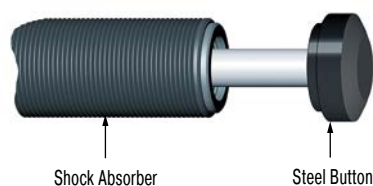

Steel Button

The buttons are made of an oxidized steel, and offer durability beyond nylon or urethane options. They fit easily onto the piston rod of the corresponding shock absorber. Steel buttons are included on most MA and SC models. Options are available all other models that do not include the standard steel button.

Mounting information

Depending on the model, these buttons may be additionally secured with an O-Ring and LOCTITE.

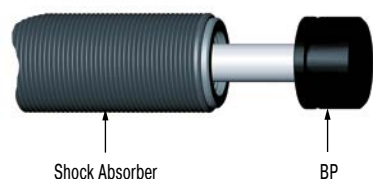

Steel/Urethane Button

These impact buttons made of urethane offer all advantages of the nylon button in terms of reducing noise and wear. They fit easily onto the piston rod of the corresponding shock absorber. The impact buttons must additionally be secured with LOCTITE.

Ordering information

New orders can include this button already installed by adding -BP to the part number.

Please refer to the accessories table on pages 40 to 43 to see which shock absorber types the steel urethane buttons are available for.

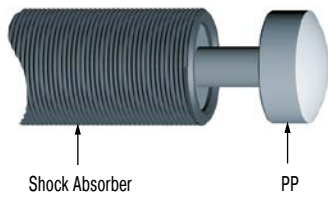

Nylon Button

While the use of industrial shock absorbers provides a considerable reduction in noise levels, adding impact buttons made of glass fiber reinforced nylon reduces noise levels even further. Additionally, use of a nylon button drastically reduces wear to the impact surface. These nylon buttons are available for the MA150 and the MC150 to MC600 shock absorber series.

Mounting information

The buttons are fitted by pressing onto the piston rod. We recommend to additionally fix the nylon button with LOCTITE.

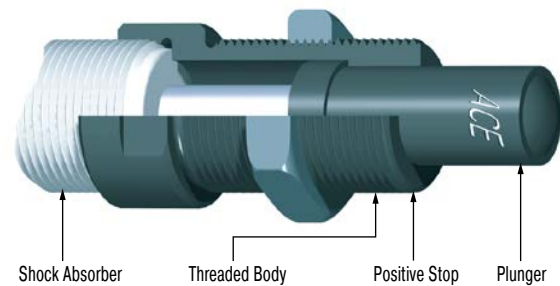

Side Load Adaptor

Rotating impact motion causes high side load forces on the piston rod. This increases bearing wear and possibly results in rod breakage or bending. With side load impact angles of more than 3° the operation lifetime of the shock absorber reduces rapidly due to increased wear of the rod bearings. The optional side load adaptor provides long lasting solution.

Ordering information

The side load adaptor can only be installed onto a shock absorber without rod end button.

Material

Threaded body and plunger: Hardened high tensile steel, hardened 610 HV1

Mounting information

Secure the side load adaptor with LOCTITE or locknut on the shock absorber. For material combination plunger/impact plate use similar hardness values. We recommend that you install the shock absorber/ side load adaptor using the thread on the side load adaptor.

Safety information

Maximum angle:

250-0141, 250-0145, 250-0146, 250-0562, 250-0762 = 12.5°

250-0554, 250-0561, 250-0763 = 25°

By repositioning the centre of the stroke of the side load plunger to be at 90 degrees to the piston rod, the side load angle can be halved. The use of an external positive stop due to high forces encountered is required.

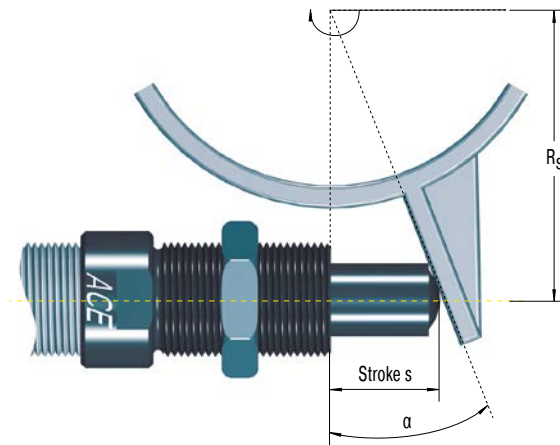

Formulae:

$$\alpha = \tan^{-1} \left(\frac{s}{R_s} \right) \quad R_{s \min} = \frac{s}{\tan \alpha \max}$$

Example:

$s = 0.025 \text{ m}$ $\alpha \max = 25^\circ$ (adapter 250-0763)

$R_s = 0.1 \text{ m}$

$$\alpha = \tan^{-1} \left(\frac{0.025}{0.1} \right) \quad R_{s \min} = \frac{0.025}{\tan 25}$$

$\alpha = 14.04^\circ$ $R_{s \min} = 0.054 \text{ m}$

- | | | | |
|---------------|---------------------|--------------|-----------------------------------|
| α | = side load angle ° | R_s | = mounting radius m |
| $\alpha \max$ | = max. angle ° | $R_{s \min}$ | = min. possible mounting radius m |
| s | = absorber stroke m | | |

Application Examples

MC25

Constant deceleration force

ACE miniature shock absorbers are the right alternative. This pneumatic module for high precision, high speed motion intentionally abandoned pneumatic end-of-travel damping. The compact miniature shock absorbers of the type MC25H-NB decelerate the linear motion safer and faster when reaching the end-of-travel position. They accept the moving load gently and decelerate it smoothly throughout the entire stroke length. Additional advantages: simpler construction, smaller pneumatic valves, lower maintenance costs as well as reduced compressed air consumption.

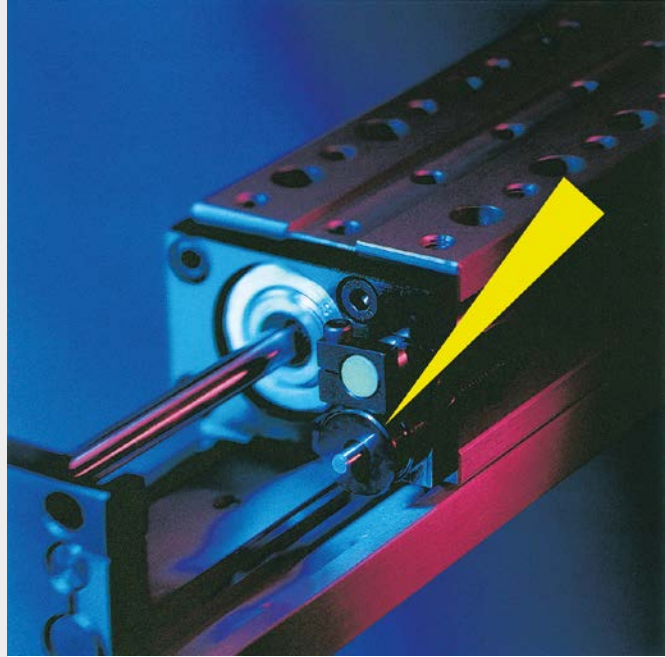
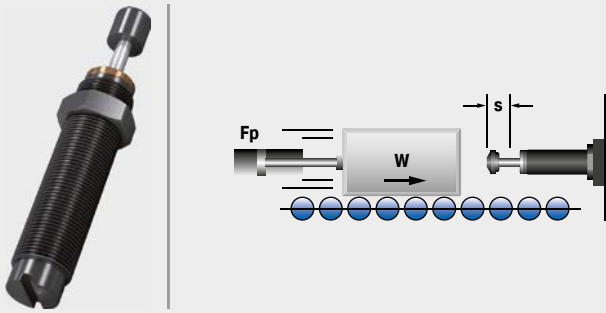

Miniature Shock Absorber in compact pneumatic module

MC225

Obstacle end positions secured

In the case of driving safety training, swinging flags are used to simulate the sudden appearance of obstacles. If the driver reacts too slowly, the flags are swung just as quickly away to avoid damage to the vehicle. In order to protect the end positions of this safety system during to and fro motion, ACE miniature shock absorbers of the type MC225H2 are installed. They come with a special side load adapter for use in this situation. Among other things, this improves the ability of the shock absorber to absorb lateral forces during to and fro motion.

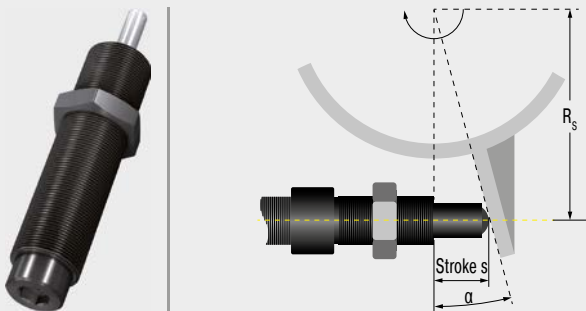

Miniature shock absorbers protect the end positions during driving safety training

Dorninger Hytronics GmbH, 4210 Unterweikersdorf, Austria

SC190
Soft end-of-travel damping on rotary movements

ACE miniature shock absorbers optimize production with minimum expenditure. The cycle rate for an assembly line producing electronic components was increased to 3,600 units/hr. Miniature shock absorbers type SC190-1 decelerate the rapid transfer movements on the production line and using soft damping methods optimize the pick up and set down of components. This soft deceleration technique has increased production and reduced maintenance on the portal and rotary actuator modules. The optional side load adaptor protects the shock absorber from high side load forces and increases the operating lifetime. Using ACE shock absorbers reduces maintenance costs by 50 % and running costs by 20 %, diminishing energy consumption.

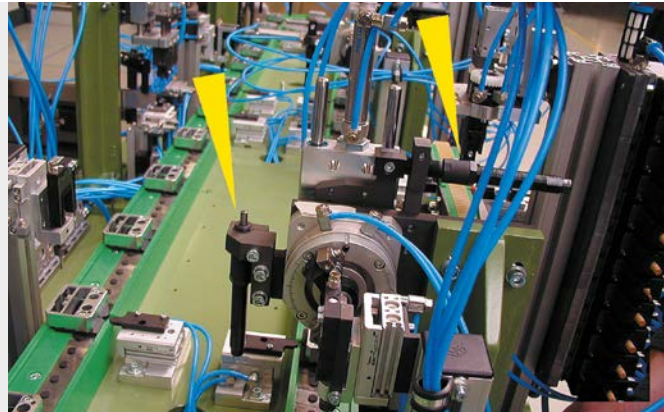

Optimised production in the electronics industry
Stebie Maschinenbau GmbH, Germany

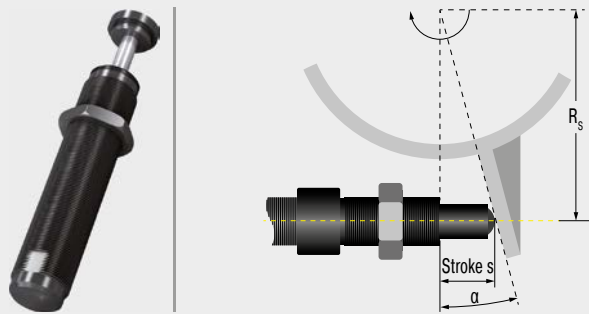

Industrial Shock Absorbers

Absorbers suited for all loads

ACE industrial shock absorbers work hard. Their application means moving loads are evenly decelerated over the full stroke. The result: the lowest braking force and shortest braking time. The MAGNUM series from ACE is viewed as the reference standard for medium-sized damping technology.

Many innovations such as diaphragm accumulators, long life seals, hardened inner pressure chambers and make a decisive contribution towards extension of the service life. This means that the effective load range can be increased considerably, providing users with more scope with respect to the absorber size and greater utilization of the machine's output. ACE offers a wide range of matching accessories for all absorber series. This eliminates internal production of assembly parts which involves high costs and loss of time.

Innovative damping techniques

Reference class for medium sizes

Less stress on the machine

Increase of production figures

Long machine service lives



Industrial Shock Absorbers



MC33 to MC64

Page 56

Self-Compensating

High energy absorption and robust design

Linear slides, Swivel units, Turntables, Portal systems



MC33-V4A to MC64-V4A

Page 60

Self-Compensating, Stainless Steel

Optimum corrosion protection

Linear slides, Swivel units, Turntables, Food industry



MC33-HT to MC64-HT

Page 64

Self-Compensating

Extreme temperature and high cycle applications

Linear slides, Swivel units, Turntables, Machines and plants



MC33-LT to MC64-LT

Page 68

Self-Compensating

Extreme temperature and high cycle applications

Linear slides, Swivel units, Turntables, Machines and plants



SC33 to SC45

Page 72

Self-Compensating, Piston Tube Technology

Piston tube design for maximum energy absorption

Turntables, Swivel units, Robot arms, Linear slides



MA/ML33 to MA/ML64

Page 76

Adjustable

High energy absorption and progressive adjustment

Linear slides, Swivel units, Turntables, Portal systems



SASL1 1/8

Page 80

Adjustable

Low velocity and high effective weight range

Linear slides, Pneumatic cylinders, Swivel units, Handling modules



SALD1/2 to SALD1 1/8

Page 82

Adjustable

High energy absorption and a wide effective weight range

Linear slides, Pneumatic cylinders, Swivel units, Handling modules



SALDN3/4

Page 86

Adjustable

High energy absorption and a wide effective weight range

Linear slides, Pneumatic cylinders, Swivel units, Handling modules

MC33 to MC64

High energy absorption and robust design

Self-Compensating

Energy capacity 1,505 in-lbs/Cycle to

50,000 in-lbs/Cycle

Stroke 0.91 in to 5.91 in

The latest damper technology: The combination of the latest sealing technology, annealed guide bearing and integrated positive stop make these self-compensating shock absorbers from ACE'S MAGNUM range so successful. After all, users benefit from the longer service life of the products, even in the most difficult environments. A continuous outer thread and extensive accessories make their contribution to the success story of the MC33 to MC64.

High energy absorption in a compact design and a wide damping range lead to huge advantages in practice. Alongside generally more compact designs, these small yet very powerful absorbers enable full use of the machine's performance. Self-compensating shock absorbers react to changing energy conditions, without adjustment.

These self-compensating industrial shock absorbers are used in all areas of industrial automation and machine engineering, especially in automation and for gantries.

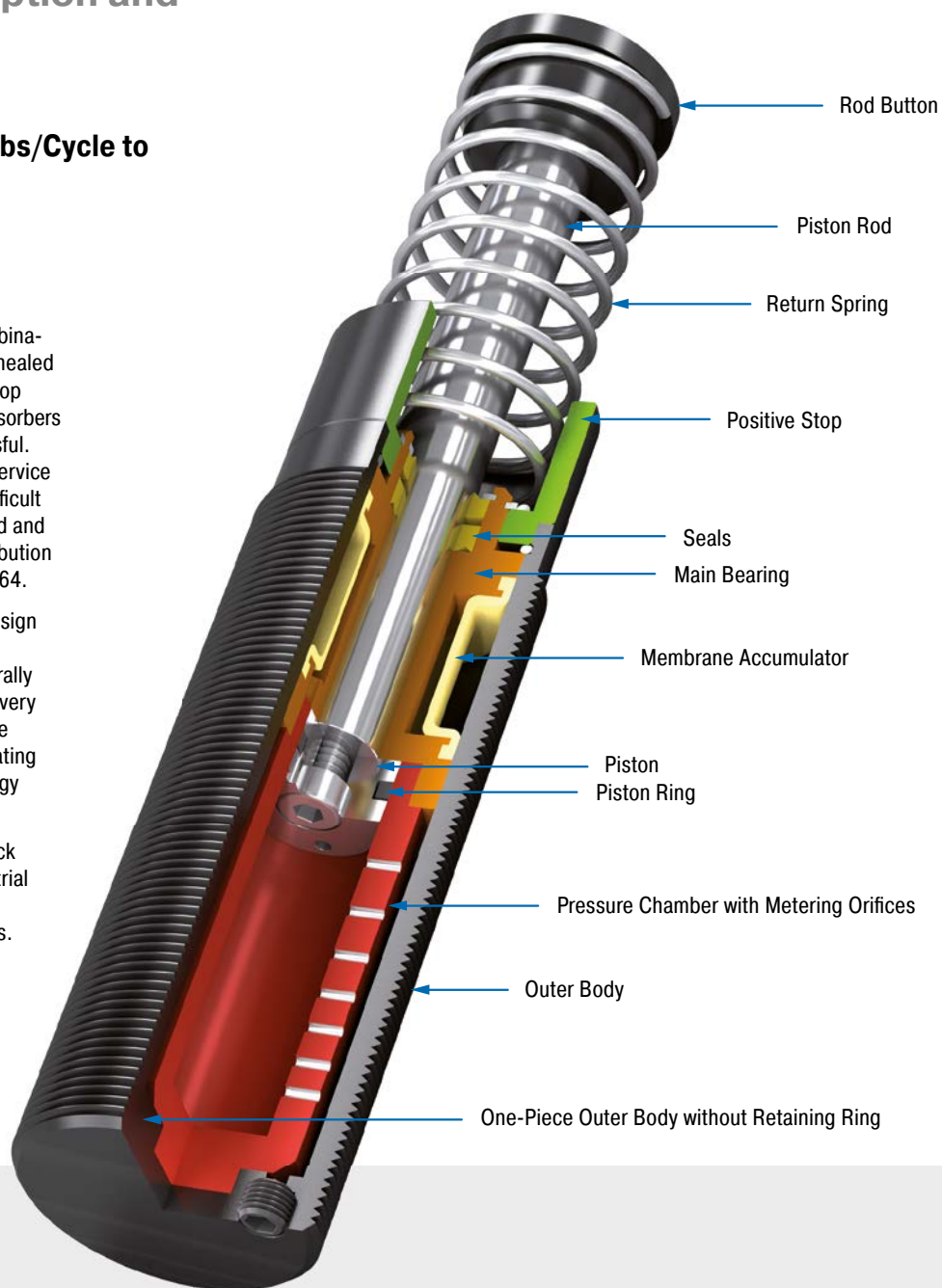

Technical Data

Energy capacity: 1,505 in-lbs/Cycle to 50,000 in-lbs/Cycle

Impact velocity range: 0.5 ft/sec to 16.5 ft/sec. Other speeds on request.

Operating temperature range: 10 °F to 150 °F. Other temperatures on request.

Mounting: In any position

Positive stop: Integrated

Material: Outer body: Nitride hardened steel; Piston rod: Hard chrome plated steel; Rod end button: Hardened steel and corrosion-resistant coating; Return spring: Zinc plated or plastic-coated steel; Accessories: Steel with black oxide finish or nitride hardened

Damping medium: Automatic Transmission Fluid (ATF)

Application field: Linear slides, Swivel units, Turntables, Portal systems, Machines and plants, Tool machines, Machining centers, Z-axes, Impact panels, Handling modules

Note: A noise reduction of 3 dB to 7 dB is possible when using the special impact button. For emergency use only applications and for continuous use (with additional cooling) it is sometimes possible to exceed the published max. capacity ratings. In this case, please consult ACE.

Safety information: External materials in the surrounding area can attack the seal components and lead to a shorter service life. Please contact ACE for appropriate solution suggestions. Do not paint the shock absorbers due to heat emission.

On request: Special oils, nickel-plated, increased corrosion protection, mounting inside air cylinders or other special options are available on request.

MC33

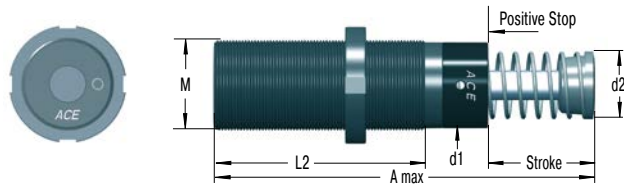

Product available for UNF and metric thread (for metric add suffix -M from part number)
M33x1.5, M36x1.5 and M42x1.5 also available to order

250-0038 Locking Ring

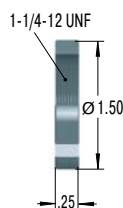

250-0016 Rectangular Flange

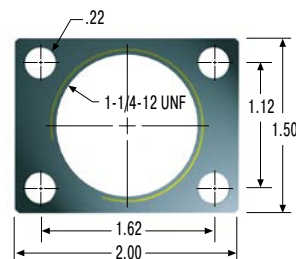

250-0292 Locking Ring

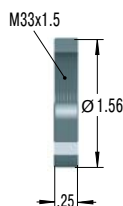

250-0293 Rectangular Flange

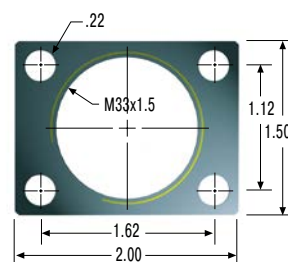

The calculation and selection of the most suitable damper should be carried out or be approved by ACE.

Model Type Prefix

Standard Models

MC: Self-Contained with return spring, self-compensating

Special Models

MCA: Air/Oil return without return spring. Use only with external air/oil tank.

MCS: Air/Oil return with return spring. Use only with external air/oil tank.

MCN: Self-Contained without return spring

Ordering Example

Self-Compensating MC3325M-1
 33 for 1-1/4-12 UNF or M33 threads
 Stroke 0.98" (25 mm)
 Metric Thread
 (omitted when using thread UNF 1 1/4-12)
 Effective Weight Range Version

Dimensions

| TYPES | Stroke inch | A max. inch | d1 inch | d2 inch | L2 inch | M |
|--------|----------------|----------------|------------|------------|------------|------------------------|
| MC3325 | 0.91 | 5.44 | 1.15 | 1.00 | 3.25 | 1-1/4-12 UNF / M33x1.5 |
| MC3350 | 1.91 | 7.44 | 1.15 | 1.00 | 4.25 | 1-1/4-12 UNF / M33x1.5 |

Performance

| TYPES | Max. Energy Capacity | | | | Effective Weight | | | Return Force min. lbs | Return Force max. lbs | Return Time s | Side Load Angle max. ° | Weight lbs |
|----------|---|----------------------------|---|--|-----------------------------|-----------------------------|----------|-----------------------------|-----------------------------|---------------------|------------------------------|---------------|
| | ¹ E ₃ in-lbs/cycle | E ₄ in-lbs/h | E ₄ with Air/Oil Tank in-lbs/h | E ₄ with Oil Recirculation in-lbs/h | ² We min. lbs | ² We max. lbs | Hardness | | | | | |
| MC3325-0 | 1,505 | 670,000 | 1,100,000 | 1,500,000 | 7 | 24 | -0 | 10.3 | 19.8 | 0.03 | 4 | 1.12 |
| MC3325-1 | 1,505 | 670,000 | 1,100,000 | 1,500,000 | 20 | 80 | -1 | 10.3 | 19.8 | 0.03 | 4 | 1.12 |
| MC3325-2 | 1,505 | 670,000 | 1,100,000 | 1,500,000 | 68 | 272 | -2 | 10.3 | 19.8 | 0.03 | 4 | 1.12 |
| MC3325-3 | 1,505 | 670,000 | 1,100,000 | 1,500,000 | 230 | 920 | -3 | 10.3 | 19.8 | 0.03 | 4 | 1.12 |
| MC3325-4 | 1,505 | 670,000 | 1,100,000 | 1,500,000 | 780 | 3,120 | -4 | 10.3 | 19.8 | 0.03 | 4 | 1.12 |
| MC3350-0 | 2,920 | 760,000 | 1,200,000 | 1,600,000 | 11 | 48 | -0 | 9.9 | 10.3 | 0.06 | 3 | 1.39 |
| MC3350-1 | 2,920 | 760,000 | 1,200,000 | 1,600,000 | 40 | 160 | -1 | 9.9 | 10.3 | 0.06 | 3 | 1.39 |
| MC3350-2 | 2,920 | 760,000 | 1,200,000 | 1,600,000 | 136 | 544 | -2 | 9.9 | 10.3 | 0.06 | 3 | 1.39 |
| MC3350-3 | 2,920 | 760,000 | 1,200,000 | 1,600,000 | 460 | 1,840 | -3 | 9.9 | 10.3 | 0.06 | 3 | 1.39 |
| MC3350-4 | 2,920 | 760,000 | 1,200,000 | 1,600,000 | 1,560 | 6,240 | -4 | 9.9 | 10.3 | 0.06 | 3 | 1.39 |

¹ For emergency use only applications it is sometimes possible to exceed the above ratings. Please consult ACE for further details.

² The effective weight range limits can be raised or lowered to special order.

³ For applications with higher side load angles please contact ACE.

Self-Compensating

MC45

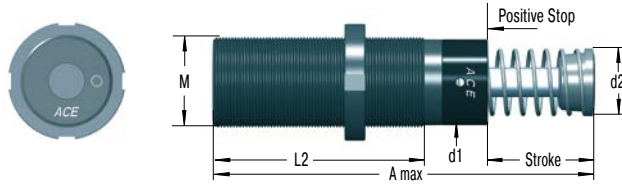

Product available for UNF and metric thread (for metric add suffix -M from part number)

250-0041
Locking Ring

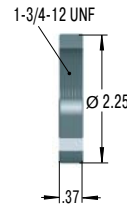

250-0023
Square Flange

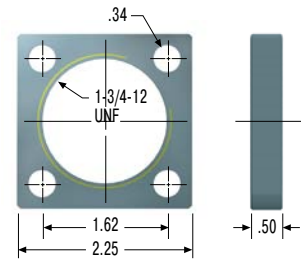

250-0024
Rectangular Flange

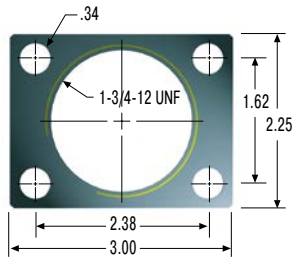

250-0299
Rectangular Flange

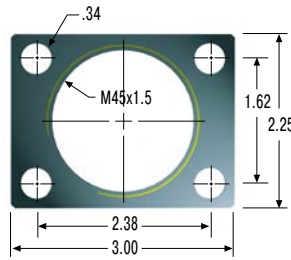

250-0297
Locking Ring

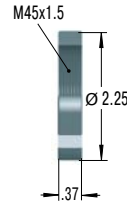

250-0298
Square Flange

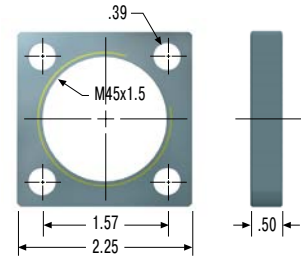

The calculation and selection of the most suitable damper should be carried out or be approved by ACE.

Model Type Prefix

Standard Models

MC: Self-Contained with return spring, self-compensating

Special Models

MCA: Air/Oil return without return spring. Use only with external air/oil tank.

MCS: Air/Oil return with return spring. Use only with external air/oil tank.

MCN: Self-Contained without return spring

Ordering Example

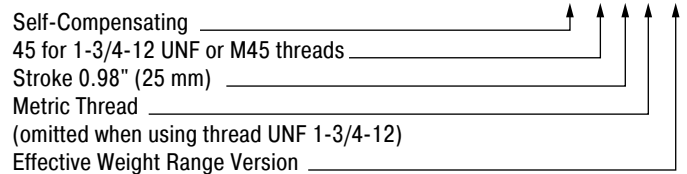

Dimensions

| TYPES | Stroke inch | A max. inch | d1 inch | d2 inch | L2 inch | M |
|--------|----------------|----------------|------------|------------|------------|------------------------|
| MC4525 | 0.91 | 5.69 | 1.65 | 1.38 | 3.72 | 1-3/4-12 UNF / M45x1.5 |
| MC4550 | 1.91 | 7.69 | 1.00 | 1.15 | 4.72 | 1-3/4-12 UNF / M45x1.5 |
| MC4575 | 2.91 | 9.69 | 1.65 | 1.38 | 5.72 | 1-3/4-12 UNF / M45x1.5 |

Performance

| TYPES | Max. Energy Capacity | | | | Effective Weight | | | Return Force min. lbs | Return Force max. lbs | Return Time s | Side Load Angle max. ° | Weight lbs |
|----------|---|----------------------------|---|--|------------------|----------------|----------|-----------------------------|-----------------------------|---------------------|------------------------------|---------------|
| | ¹ E ₃ in-lbs/cycle | E ₄ in-lbs/h | E ₄ with Air/Oil Tank in-lbs/h | E ₄ with Oil Recirculation in-lbs/h | We min. lbs | We max. lbs | Hardness | | | | | |
| MC4525-0 | 3,275 | 950,000 | 1,400,000 | 1,700,000 | 15 | 59 | -0 | 15.1 | 22.8 | 0.03 | 4 | 2.49 |
| MC4525-1 | 3,275 | 950,000 | 1,400,000 | 1,700,000 | 50 | 200 | -1 | 15.1 | 22.8 | 0.03 | 4 | 2.49 |
| MC4525-2 | 3,275 | 950,000 | 1,400,000 | 1,700,000 | 170 | 680 | -2 | 15.1 | 22.8 | 0.03 | 4 | 2.49 |
| MC4525-3 | 3,275 | 950,000 | 1,400,000 | 1,700,000 | 575 | 2,300 | -3 | 15.1 | 22.8 | 0.03 | 4 | 2.49 |
| MC4525-4 | 3,275 | 950,000 | 1,400,000 | 1,700,000 | 1,950 | 7,800 | -4 | 15.1 | 22.8 | 0.03 | 4 | 2.49 |
| MC4550-0 | 6,550 | 1,000,000 | 1,700,000 | 2,200,000 | 28 | 119 | -0 | 15.1 | 32.2 | 0.08 | 3 | 3.00 |
| MC4550-1 | 6,550 | 1,000,000 | 1,700,000 | 2,200,000 | 100 | 400 | -1 | 15.1 | 32.2 | 0.08 | 3 | 3.00 |
| MC4550-2 | 6,550 | 1,000,000 | 1,700,000 | 2,200,000 | 340 | 1,360 | -2 | 15.1 | 32.2 | 0.08 | 3 | 3.00 |
| MC4550-3 | 6,550 | 1,000,000 | 1,700,000 | 2,200,000 | 1,150 | 4,600 | -3 | 15.1 | 32.2 | 0.08 | 3 | 3.00 |
| MC4550-4 | 6,550 | 1,000,000 | 1,700,000 | 2,200,000 | 3,900 | 15,600 | -4 | 15.1 | 32.2 | 0.08 | 3 | 3.00 |
| MC4575-0 | 10,000 | 1,300,000 | 2,000,000 | 2,500,000 | 44 | 176 | -0 | 11.7 | 40.3 | 0.11 | 2 | 3.51 |
| MC4575-1 | 10,000 | 1,300,000 | 2,000,000 | 2,500,000 | 150 | 600 | -1 | 11.7 | 40.3 | 0.11 | 2 | 3.51 |
| MC4575-2 | 10,000 | 1,300,000 | 2,000,000 | 2,500,000 | 510 | 2,040 | -2 | 11.7 | 40.3 | 0.11 | 2 | 3.51 |
| MC4575-3 | 10,000 | 1,300,000 | 2,000,000 | 2,500,000 | 1,370 | 6,920 | -3 | 11.7 | 40.3 | 0.11 | 2 | 3.51 |
| MC4575-4 | 10,000 | 1,300,000 | 2,000,000 | 2,500,000 | 5,850 | 23,400 | -4 | 11.7 | 40.3 | 0.11 | 2 | 3.51 |

¹ For emergency use only applications it is sometimes possible to exceed the above ratings. Please consult ACE for further details.

² The effective weight range limits can be raised or lowered to special order.

³ For applications with higher side load angles please contact ACE.

MC64

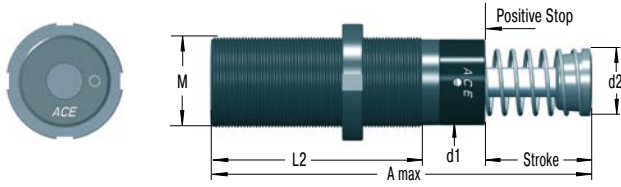

Product available for UNF and metric thread (for metric add suffix -M from part number)
 5.91" stroke model does not include stop collar.
 Positive stop is provided by the rod button (Ø 2.36") and a stop block.

250-0042 Locking Ring

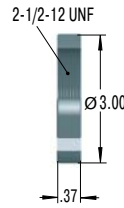

250-0028 Square Flange

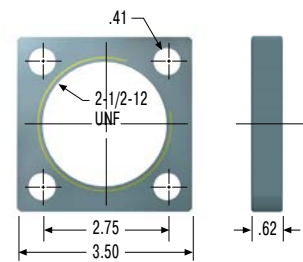

250-0301 Locking Ring

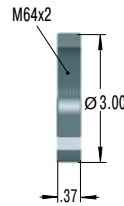

250-0302 Square Flange

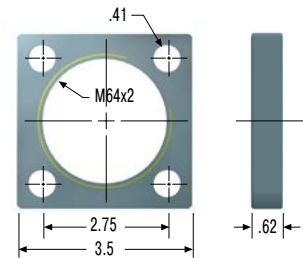

The calculation and selection of the most suitable damper should be carried out or be approved by ACE.

Model Type Prefix

Standard Models

MC: Self-Contained with return spring, self-compensating

Special Models

MCA: Air/Oil return without return spring. Use only with external air/oil tank.

MCS: Air/Oil return with return spring. Use only with external air/oil tank.

MCN: Self-Contained without return spring

Ordering Example

Self-Compensating MC6450M-1
 64 for 2-1/2-12 UNF or M64 threads
 Stroke 0.97" (50 mm)
 Metric Thread
 (omitted when using thread UNF 2-1/2-12)
 Effective Weight Range Version

Dimensions

| TYPES | Stroke inch | A max. inch | d1 inch | d2 inch | L2 inch | M |
|---------|----------------|----------------|------------|------------|------------|----------------------|
| MC6450 | 1.91 | 8.85 | 2.37 | 1.90 | 5.5 | 2-1/2-12 UNF / M64x2 |
| MC64100 | 3.91 | 12.85 | 2.37 | 1.90 | 7.5 | 2-1/2-12 UNF / M64x2 |
| MC64150 | 5.91 | 17.73 | 2.37 | 1.90 | 9.5 | 2-1/2-12 UNF / M64x2 |

Performance

| TYPES | Max. Energy Capacity | | | | Effective Weight | | | Return Force min. lbs | Return Force max. lbs | Return Time s | Side Load Angle max. ° | Weight lbs |
|-----------|---|----------------------------|---|--|-----------------------------|-----------------------------|----------|-----------------------------|-----------------------------|---------------------|------------------------------|---------------|
| | ¹ E ₃ in-lbs/cycle | E ₄ in-lbs/h | E ₄ with Air/Oil Tank in-lbs/h | E ₄ with Oil Recirculation in-lbs/h | ² We min. lbs | ² We max. lbs | Hardness | | | | | |
| MC6450-0 | 16,550 | 1,300,000 | 2,600,000 | 3,400,000 | 308 | 1,190 | -0 | 20.1 | 34.9 | 0.12 | 4 | 6.39 |
| MC6450-1 | 16,550 | 1,300,000 | 2,600,000 | 3,400,000 | 300 | 1,200 | -1 | 20.1 | 34.9 | 0.12 | 4 | 6.39 |
| MC6450-2 | 16,550 | 1,300,000 | 2,600,000 | 3,400,000 | 1,020 | 4,080 | -2 | 20.1 | 34.9 | 0.12 | 4 | 6.39 |
| MC6450-3 | 16,550 | 1,300,000 | 2,600,000 | 3,400,000 | 3,460 | 13,480 | -3 | 20.1 | 34.9 | 0.12 | 4 | 6.39 |
| MC6450-4 | 16,550 | 1,300,000 | 2,600,000 | 3,400,000 | 11,700 | 46,800 | -4 | 20.1 | 34.9 | 0.12 | 4 | 6.39 |
| MC64100-0 | 33,000 | 1,700,000 | 3,400,000 | 4,400,000 | 154 | 617 | -0 | 23.5 | 61.0 | 0.34 | 3 | 8.16 |
| MC64100-1 | 33,000 | 1,700,000 | 3,400,000 | 4,400,000 | 600 | 2,400 | -1 | 23.5 | 61.0 | 0.34 | 3 | 8.16 |
| MC64100-2 | 33,000 | 1,700,000 | 3,400,000 | 4,400,000 | 2,040 | 8,160 | -2 | 23.5 | 61.0 | 0.34 | 3 | 8.16 |
| MC64100-3 | 33,000 | 1,700,000 | 3,400,000 | 4,400,000 | 6,920 | 27,680 | -3 | 23.5 | 61.0 | 0.34 | 3 | 8.16 |
| MC64100-4 | 33,000 | 1,700,000 | 3,400,000 | 4,400,000 | 23,400 | 93,600 | -4 | 23.5 | 61.0 | 0.34 | 3 | 8.16 |
| MC64150-0 | 50,000 | 2,200,000 | 4,400,000 | 5,700,000 | 220 | 1,014 | -0 | 16.9 | 82.2 | 0.48 | 2 | 11.25 |
| MC64150-1 | 50,000 | 2,200,000 | 4,400,000 | 5,700,000 | 900 | 3,600 | -1 | 16.9 | 82.2 | 0.48 | 2 | 11.25 |
| MC64150-2 | 50,000 | 2,200,000 | 4,400,000 | 5,700,000 | 3,060 | 12,240 | -2 | 16.9 | 82.2 | 0.48 | 2 | 11.25 |
| MC64150-3 | 50,000 | 2,200,000 | 4,400,000 | 5,700,000 | 10,380 | 41,520 | -3 | 16.9 | 82.2 | 0.48 | 2 | 11.25 |
| MC64150-4 | 50,000 | 2,200,000 | 4,400,000 | 5,700,000 | 35,100 | 140,400 | -4 | 16.9 | 82.2 | 0.48 | 2 | 11.25 |

¹ For emergency use only applications it is sometimes possible to exceed the above ratings. Please consult ACE for further details.

² The effective weight range limits can be raised or lowered to special order.

³ For applications with higher side load angles please contact ACE.

MC33-V4A to MC64-V4A

Optimum corrosion protection

Self-Compensating, Stainless Steel
Energy capacity 1,505 in-lbs/Cycle to
33,000 in-lbs/Cycle
Stroke 0.91 in to 3.91 in

The latest damper technology in stainless steel: The self-compensating industrial shock absorbers MC33 to MC64 from the tried-and-tested and popular MAGNUM range is also available with all outer components made from stainless steel, material AISI 316L (except piston rod). They are filled in the factory with special oil, which meets the permit conditions (NSF-H1) for the food industry.

Just like the standard product family, the MAGNUM stainless steel models are distinguished by their robust, modern sealing technology, high energy absorption in a compact design, integrated positive stop and a wide damping range. Equipped with a PUR head, they are available in thread sizes M33x1.5 to M64x2 with damping strokes up to 3.94 in. Self-compensating shock absorbers react to changing energy conditions, without adjustment.

These self-compensating industrial shock absorbers made of stainless steel from ACE are mainly used in the food, medical, electronics and offshore industries, but also in many other markets.

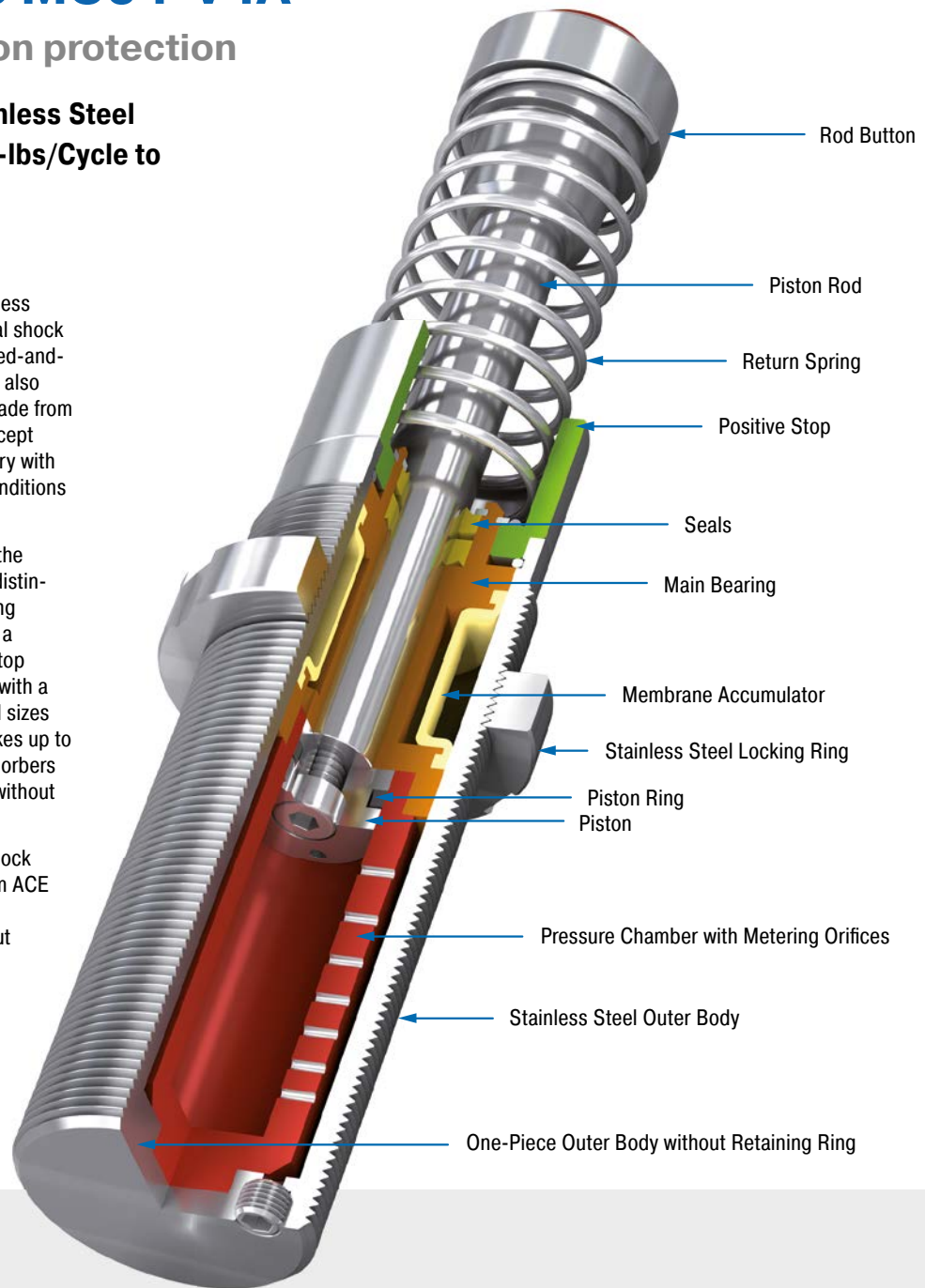

Technical Data

Energy capacity: 1,505 in-lbs/Cycle to 33,000 in-lbs/Cycle

Impact velocity range: 0.5 ft/sec to 16.5 ft/sec. Other speeds on request.

Operating temperature range: 10 °F to 150 °F. Other temperatures on request.

Mounting: In any position

Positive stop: Integrated

Material: Outer body, Main bearing, Accessories, Locking ring: Stainless steel (1.4404, AISI 316L); Piston rod: Hard chrome plated steel; Rod end button: Stainless steel (1.4404, AISI 316L) with elastomer insert; Return spring: Stainless steel

Damping medium: Special oil NSF-H1 approved

Application field: Linear slides, Swivel units, Turntables, Food industry, Medical technology, Portal systems, Machines and plants, Tool machines, Machining centers, Z-axes

Note: Impact button for noise reduction included. For emergency use only applications and for continuous use (with additional cooling) it is sometimes possible to exceed the published max. capacity ratings. In this case, please consult ACE.

Safety information: External materials in the surrounding area can attack the seal components and lead to a shorter service life. Please

contact ACE for appropriate solution suggestions. Do not paint the shock absorbers due to heat emission.

On request: Special oils, other special options and special accessories are available on request.

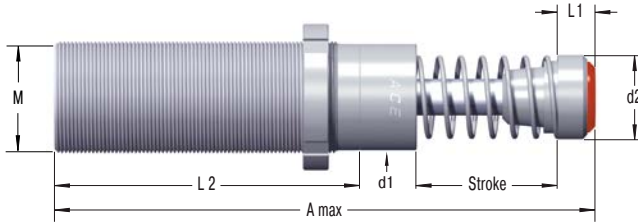
MC33M-V4A

250-0048

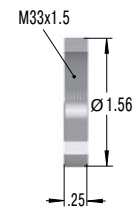
Locking Ring



The calculation and selection of the most suitable damper should be carried out or be approved by ACE.

Model Type Prefix
Standard Models

MC: Self-Contained with return spring, self-compensating

Special Models

MCA: Air/Oil return without return spring. Use only with external air/oil tank.

MCS: Air/Oil return with return spring. Use only with external air/oil tank.

MCN: Self-Contained without return spring

Ordering Example
MC3325M-2-V4A

Self-Compensating _____
 Thread Size M33 _____
 Stroke 0.98" (25 mm) _____
 Effective Weight Range Version _____
 Stainless Steel 1.4404/AISI 316L _____

Dimensions

| TYPES | Stroke mm | A max. mm | d1 mm | d2 mm | L1 mm | L2 mm | M |
|-------------|--------------|--------------|----------|----------|----------|----------|---------|
| MC3325M-V4A | 0.91 | 5.95 | 1.18 | 1.15 | 0.52 | 3.25 | M33x1.5 |
| MC3350M-V4A | 1.91 | 7.96 | 1.18 | 1.15 | 0.52 | 4.25 | M33x1.5 |

Performance

| TYPES | Max. Energy Capacity | | Effective Weight | | | Return Force min. lbs | Return Force max. lbs | Return Time s | Side Load Angle max. ° | Weight lbs |
|---------------|--------------------------------|----------------------------|-----------------------------|-----------------------------|----------|-----------------------------|-----------------------------|------------------|------------------------------|---------------|
| | E ₃ in-lbs/cycle | E ₄ in-lbs/h | ¹ We min. lbs | ¹ We max. lbs | Hardness | | | | | |
| MC3325M-0-V4A | 1,505 | 670,000 | 7 | 24 | -0 | 10.12 | 20.23 | 0.03 | 4 | 1.12 |
| MC3325M-1-V4A | 1,505 | 670,000 | 20 | 80 | -1 | 10.12 | 20.23 | 0.03 | 4 | 1.12 |
| MC3325M-2-V4A | 1,505 | 670,000 | 68 | 272 | -2 | 10.12 | 20.23 | 0.03 | 4 | 1.12 |
| MC3325M-3-V4A | 1,505 | 670,000 | 230 | 920 | -3 | 10.12 | 20.23 | 0.03 | 4 | 1.12 |
| MC3325M-4-V4A | 1,505 | 670,000 | 780 | 3,120 | -4 | 10.12 | 20.23 | 0.03 | 4 | 1.12 |
| MC3350M-0-V4A | 2,920 | 760,000 | 11 | 48 | -0 | 10.12 | 30.35 | 0.06 | 3 | 1.39 |
| MC3350M-1-V4A | 2,920 | 760,000 | 40 | 160 | -1 | 10.12 | 30.35 | 0.06 | 3 | 1.39 |
| MC3350M-2-V4A | 2,920 | 760,000 | 136 | 544 | -2 | 10.12 | 30.35 | 0.06 | 3 | 1.39 |
| MC3350M-3-V4A | 2,920 | 760,000 | 460 | 1,840 | -3 | 10.12 | 30.35 | 0.06 | 3 | 1.39 |
| MC3350M-4-V4A | 2,920 | 760,000 | 1,560 | 6,240 | -4 | 10.12 | 30.35 | 0.06 | 3 | 1.39 |

¹ For emergency use only applications it is sometimes possible to exceed the above ratings. Please consult ACE for further details.

² For applications with higher side load angles please contact ACE.

Self-Compensating, Stainless Steel

MC45M-V4A



250-0049

Locking Ring

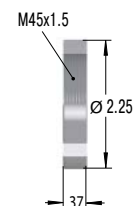

The calculation and selection of the most suitable damper should be carried out or be approved by ACE.

Model Type Prefix

Standard Models

MC: Self-Contained with return spring, self-compensating

Special Models

MCA: Air/Oil return without return spring. Use only with external air/oil tank.

MCS: Air/Oil return with return spring. Use only with external air/oil tank.

MCN: Self-Contained without return spring

Ordering Example

MC4525M-2-V4A

Self-Compensating _____
 Thread Size M45 _____
 Stroke 0.98" (25 mm) _____
 Effective Weight Range Version _____
 Stainless Steel 1.4404/AISI 316L _____

Dimensions

| TYPES | Stroke inch | A max. inch | d1 inch | d2 inch | L1 inch | L2 inch | M |
|-------------|----------------|----------------|------------|------------|------------|------------|---------|
| MC4525M-V4A | 0.91 | 6.48 | 1.65 | 1.65 | 0.76 | 3.72 | M45x1.5 |
| MC4550M-V4A | 1.91 | 8.44 | 1.65 | 1.65 | 0.76 | 4.72 | M45x1.5 |
| MC4575M-V4A | 2.91 | 10.45 | 1.65 | 1.65 | 0.76 | 5.72 | M45x1.5 |

Performance

| TYPES | Max. Energy Capacity | | Effective Weight | | | Return Force min. lbs | Return Force max. lbs | Return Time s | ² Side Load Angle max. ° | Weight lbs |
|---------------|--------------------------------|----------------------------|-----------------------------|-----------------------------|----------|-----------------------------|-----------------------------|------------------|---|---------------|
| | E ₃ in-lbs/cycle | E ₄ in-lbs/h | ¹ We min. lbs | ¹ We max. lbs | Hardness | | | | | |
| MC4525M-0-V4A | 3,275 | 950,000 | 15 | 59 | -0 | 15.1 | 22.8 | 0.03 | 4 | 2.51 |
| MC4525M-1-V4A | 3,275 | 950,000 | 50 | 200 | -1 | 15.1 | 22.8 | 0.03 | 4 | 2.51 |
| MC4525M-2-V4A | 3,275 | 950,000 | 170 | 680 | -2 | 15.1 | 22.8 | 0.03 | 4 | 2.51 |
| MC4525M-3-V4A | 3,275 | 950,000 | 575 | 2,315 | -3 | 15.1 | 22.8 | 0.03 | 4 | 2.51 |
| MC4525M-4-V4A | 3,275 | 950,000 | 1,950 | 7,804 | -4 | 15.1 | 22.8 | 0.03 | 4 | 2.51 |
| MC4550M-0-V4A | 6,550 | 1,000,000 | 28 | 119 | -0 | 15.1 | 32.2 | 0.08 | 3 | 3.00 |
| MC4550M-1-V4A | 6,550 | 1,000,000 | 100 | 400 | -1 | 15.1 | 32.2 | 0.08 | 3 | 3.00 |
| MC4550M-2-V4A | 6,550 | 1,000,000 | 340 | 1,360 | -2 | 15.1 | 32.2 | 0.08 | 3 | 3.00 |
| MC4550M-3-V4A | 6,550 | 1,000,000 | 1,150 | 4,600 | -3 | 15.1 | 32.2 | 0.08 | 3 | 3.00 |
| MC4550M-4-V4A | 6,550 | 1,000,000 | 3,900 | 15,600 | -4 | 11.7 | 40.3 | 0.08 | 3 | 3.00 |
| MC4575M-0-V4A | 10,000 | 1,300,000 | 44 | 176 | -0 | 11.7 | 40.3 | 0.11 | 2 | 3.51 |
| MC4575M-1-V4A | 10,000 | 1,300,000 | 150 | 600 | -1 | 11.7 | 40.3 | 0.11 | 2 | 3.51 |
| MC4575M-2-V4A | 10,000 | 1,300,000 | 510 | 2,040 | -2 | 11.7 | 40.3 | 0.11 | 2 | 3.51 |
| MC4575M-3-V4A | 10,000 | 1,300,000 | 1,370 | 6,920 | -3 | 11.7 | 40.3 | 0.11 | 2 | 3.51 |
| MC4575M-4-V4A | 10,000 | 1,300,000 | 5,850 | 23,400 | -4 | 11.7 | 40.3 | 0.11 | 2 | 3.51 |

¹ For emergency use only applications it is sometimes possible to exceed the above ratings. Please consult ACE for further details.

² For applications with higher side load angles please contact ACE.

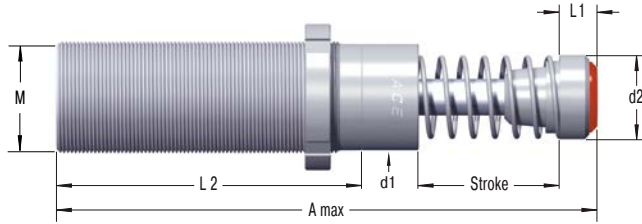
MC64M-V4A

250-0179

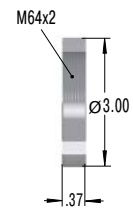
Locking Ring



The calculation and selection of the most suitable damper should be carried out or be approved by ACE.

Model Type Prefix
Standard Models

MC: Self-Contained with return spring, self-compensating

Special Models

MCA: Air/Oil return without return spring. Use only with external air/oil tank.

MCS: Air/Oil return with return spring. Use only with external air/oil tank.

MCN: Self-Contained without return spring

Ordering Example
MC6450M-2-V4A

Self-Compensating _____
 Thread Size M64 _____
 Stroke 0.97" (50 mm) _____
 Effective Weight Range Version _____
 Stainless Steel 1.4404/AISI 316L _____

Dimensions

| TYPES | Stroke inch | A max. inch | d1 inch | d2 inch | L1 inch | L2 inch | M |
|----------------|----------------|----------------|------------|------------|------------|------------|-------|
| MC6450M-0-V4A | 1.91 | 9.61 | 2.36 | 2.36 | 0.75 | 5.5 | M64x2 |
| MC64100M-0-V4A | 3.91 | 13.59 | 2.36 | 2.36 | 0.75 | 7.5 | M64x2 |

Performance

| TYPES | Max. Energy Capacity | | Effective Weight | | | Return Force min. lbs | Return Force max. lbs | Return Time s | Side Load Angle | | Weight lbs |
|----------------|--------------------------------|----------------------------|-----------------------------|-----------------------------|----------|-----------------------------|-----------------------------|------------------|-----------------|------|---------------|
| | E ₃ in-lbs/cycle | E ₄ in-lbs/h | ¹ We min. lbs | ¹ We max. lbs | Hardness | | | | max. ° | min. | |
| MC6450M-0-V4A | 16,550 | 1,300,000 | 308 | 1,190 | -0 | 20.1 | 34.9 | 0.12 | 4 | 6.39 | |
| MC6450M-1-V4A | 16,550 | 1,300,000 | 300 | 1,200 | -1 | 20.1 | 34.9 | 0.12 | 4 | 6.39 | |
| MC6450M-2-V4A | 16,550 | 1,300,000 | 1,020 | 4,080 | -2 | 20.1 | 34.9 | 0.12 | 4 | 6.39 | |
| MC6450M-3-V4A | 16,550 | 1,300,000 | 3,460 | 13,480 | -3 | 20.1 | 34.9 | 0.12 | 4 | 6.39 | |
| MC6450M-4-V4A | 16,550 | 1,300,000 | 11,700 | 46,800 | -4 | 20.1 | 34.9 | 0.12 | 4 | 6.39 | |
| MC64100M-0-V4A | 33,000 | 1,700,000 | 154 | 617 | -0 | 23.5 | 61.0 | 0.34 | 3 | 8.16 | |
| MC64100M-1-V4A | 33,000 | 1,700,000 | 600 | 2,400 | -1 | 23.5 | 61.0 | 0.34 | 3 | 8.16 | |
| MC64100M-2-V4A | 33,000 | 1,700,000 | 2,040 | 8,160 | -2 | 23.5 | 61.0 | 0.34 | 3 | 8.16 | |
| MC64100M-3-V4A | 33,000 | 1,700,000 | 6,920 | 27,680 | -3 | 23.5 | 61.0 | 0.34 | 3 | 8.16 | |
| MC64100M-4-V4A | 33,000 | 1,700,000 | 23,400 | 93,600 | -4 | 23.5 | 61.0 | 0.34 | 3 | 8.16 | |

¹ For emergency use only applications it is sometimes possible to exceed the above ratings. Please consult ACE for further details.

² For applications with higher side load angles please contact ACE.

MC33-HT to MC64-HT

Extreme temperature and high cycle applications

Self-Compensating

Energy capacity 1,505 in-lbs/Cycle to 33,000 in-lbs/Cycle

Stroke 0.91 in to 3.91 in

Greater application range: just like all MAGNUM types from the product family MC33 to MC64, the HT (high temperature) industrial shock absorbers are also made from one solid piece. They use special seals and fluids. This means that these versions can even be used at extreme temperatures of 32 °F to +302 °F in order to safely and reliably damp masses and absorb 100 % of the kinetic energy.

These ready-to-install machine elements are recommended even under the most unfavorable conditions. Additional benefits are their robust, innovative sealing technology, high energy absorption in a compact design, fixed positive stop and a wide damping range. Self-compensating shock absorbers react to changing energy conditions, without adjustment.

Designed for use in extreme temperature ranges, these self-compensating industrial shock absorbers are suitable almost anywhere in plant, industrial, automation and machine engineering.

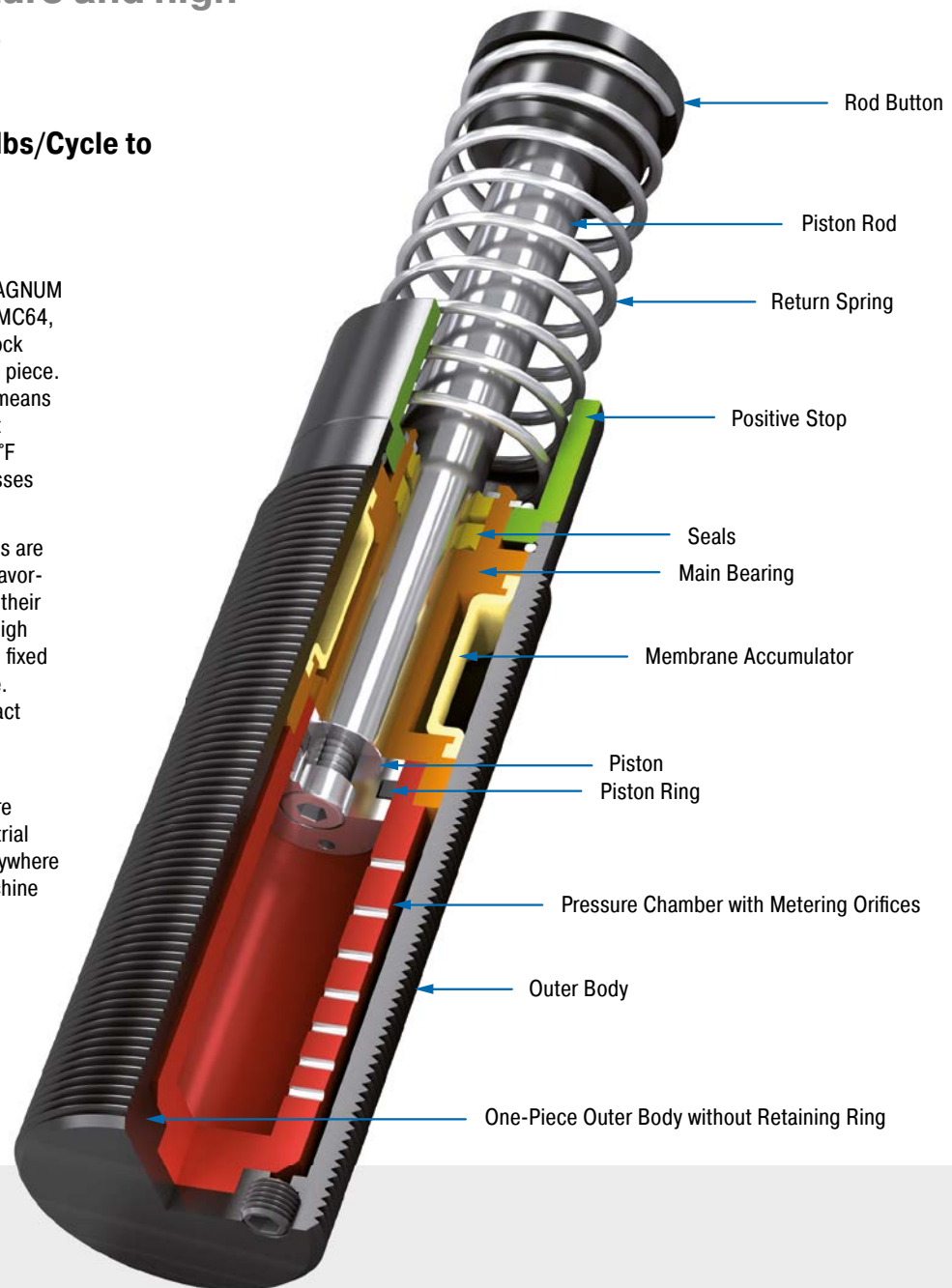

Technical Data

Energy capacity: 1,505 in-lbs/Cycle to 33,000 in-lbs/Cycle

Impact velocity range: 0.5 ft/sec to 16.5 ft/sec. Other speeds on request.

Operating temperature range: 32 °F to 302 °F

Mounting: In any position

Positive stop: Integrated

Material: Outer body: Nitride hardened steel; Piston rod: Hard chrome plated steel; Rod end button: Hardened steel and corrosion-resistant coating; Return spring: Zinc plated or plastic-coated steel; Accessories: Steel with black oxide finish or nitride hardened

Damping medium: Synthetic high temperature oil

Application field: Linear slides, Swivel units, Turntables, Machines and plants, Tool machines, Machining centers, Z-axes

Note: A noise reduction of 3 dB to 7 dB is possible when using the special impact button.

Safety information: External materials in the surrounding area can attack the seal components and lead to a shorter service life. Please contact ACE for appropriate solution suggestions. Do not paint the shock absorbers due to heat emission.

On request: Nickel-plated, increased corrosion protection, mounting inside air cylinders or other special options are available on request. Adjustable HT and LT shock absorbers.

MC33-HT

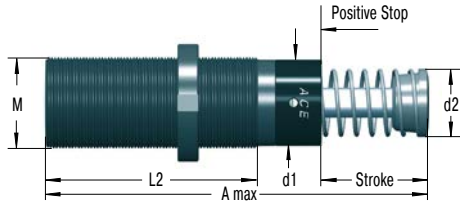

Product available for UNF and metric thread (for metric add suffix -M from part number)
M33x1.5, M36x1.5 and M42x1.5 also available to order

250-0038 Locking Ring

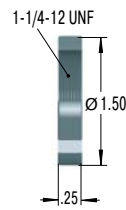

250-0016 Rectangular Flange

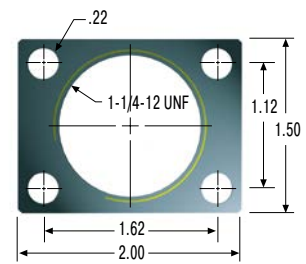

250-0292 Locking Ring

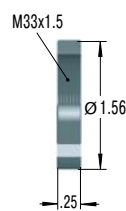

250-0293 Rectangular Flange

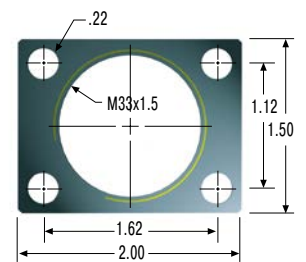

The calculation and selection of the most suitable damper should be carried out or be approved by ACE.

Complete details required when ordering

- Load to be decelerated: W (lbs)
- Impact velocity: v (ft/s)
- Propelling force: F (lbs)
- Operating cycles per hour: c (/hr)
- Number of absorbers in parallel: n
- Ambient temperature: °F

Ordering Example

Self-Compensating _____
 33 for 1-1/4-12 UNF or M33 threads _____
 Stroke 1.97" (50 mm) _____
 Metric Thread _____
 (omitted when using thread UNF 1-1/4-12)
 Effective Weight Range Version _____
 HT = Version for High Temperature Use _____

MC3350M-2-HT

Dimensions

| TYPES | Stroke inch | A max. inch | d1 inch | d2 inch | L2 inch | M |
|-----------|----------------|----------------|------------|------------|------------|------------------------|
| MC3325-HT | 0.91 | 5.44 | 1.15 | 1.00 | 3.25 | 1-1/4-12 UNF / M33x1.5 |
| MC3350-HT | 1.91 | 7.44 | 1.15 | 1.00 | 4.25 | 1-1/4-12 UNF / M33x1.5 |

Performance

| TYPES | Max. Energy Capacity | | | Effective Weight | | | Side Load Angle max. ° | Weight lbs |
|-------------|--------------------------------|-------------------------------------|--------------------------------------|-----------------------------|-----------------------------|----------|---------------------------|---------------|
| | E ₃ in-lbs/cycle | E ₄ at 68 °F in-lbs/h | E ₄ at 212 °F in-lbs/h | ¹ We min. lbs | ¹ We max. lbs | Hardness | | |
| MC3325-0-HT | 1,505 | 1,902,909 | 725,760 | 6 | 24 | -0 | 4 | 1.12 |
| MC3325-1-HT | 1,505 | 1,902,909 | 725,760 | 20 | 80 | -1 | 4 | 1.12 |
| MC3325-2-HT | 1,505 | 1,902,909 | 725,760 | 68 | 272 | -2 | 4 | 1.12 |
| MC3325-3-HT | 1,505 | 1,902,909 | 725,760 | 230 | 920 | -3 | 4 | 1.12 |
| MC3325-4-HT | 1,505 | 1,902,909 | 725,760 | 780 | 3,120 | -4 | 4 | 1.12 |
| MC3350-0-HT | 2,920 | 2,159,580 | 823,118 | 11 | 48 | -0 | 3 | 1.39 |
| MC3350-1-HT | 2,920 | 2,159,580 | 823,118 | 40 | 160 | -1 | 3 | 1.39 |
| MC3350-2-HT | 2,920 | 2,159,580 | 823,118 | 136 | 544 | -2 | 3 | 1.39 |
| MC3350-3-HT | 2,920 | 2,159,580 | 823,118 | 460 | 1,840 | -3 | 3 | 1.39 |
| MC3350-4-HT | 2,920 | 2,159,580 | 823,118 | 1,560 | 6,240 | -4 | 3 | 1.39 |

¹ The effective weight range limits can be raised or lowered to special order.
² For applications with higher side load angles please contact ACE.

Self-Compensating

MC45-HT

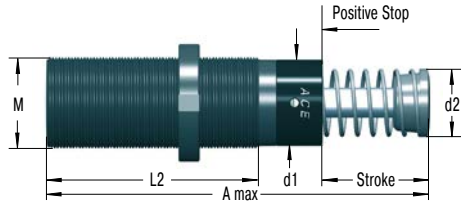

Product available for UNF and metric thread (for metric add suffix -M from part number)

250-0041 Locking Ring

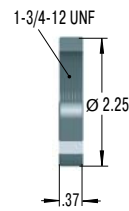

250-0023 Square Flange

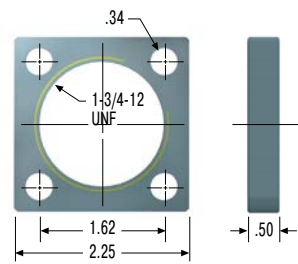

250-0024 Rectangular Flange

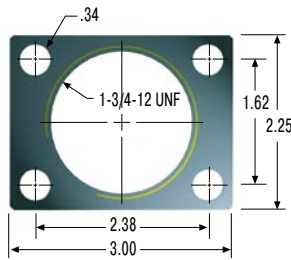

250-0299 Rectangular Flange

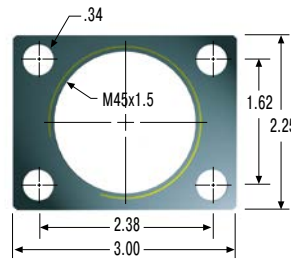

250-0297 Locking Ring

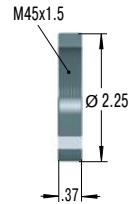

250-0298 Square Flange

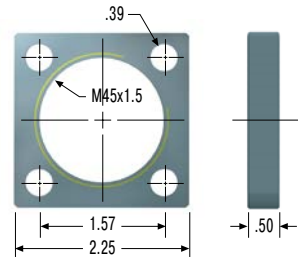

The calculation and selection of the most suitable damper should be carried out or be approved by ACE.

Complete details required when ordering

- Load to be decelerated: W (lbs)
- Impact velocity: v (ft/s)
- Propelling force: F (lbs)
- Operating cycles per hour: c (/hr)
- Number of absorbers in parallel: n
- Ambient temperature: °F

Ordering Example

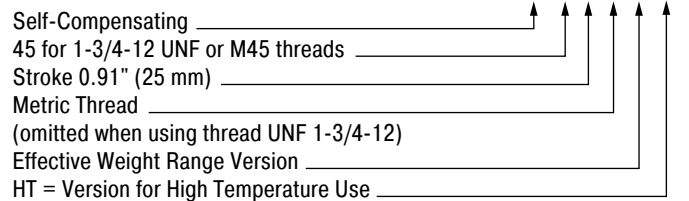

Dimensions

| TYPES | Stroke inch | A max. inch | d1 inch | d2 inch | L2 inch | M |
|-----------|----------------|----------------|------------|------------|------------|------------------------|
| MC4525-HT | 0.91 | 5.69 | 1.65 | 1.38 | 3.72 | 1-3/4-12 UNF / M45x1.5 |
| MC4550-HT | 1.91 | 7.69 | 1.65 | 1.38 | 4.72 | 1-3/4-12 UNF / M45x1.5 |

Performance

| TYPES | Max. Energy Capacity | | | Effective Weight | | | Side Load Angle max. ° | Weight lbs |
|-------------|--------------------------------|-------------------------------------|--------------------------------------|-----------------------------|-----------------------------|----------|---------------------------|---------------|
| | E ₃ in-lbs/cycle | E ₄ at 68 °F in-lbs/h | E ₄ at 212 °F in-lbs/h | ¹ We min. lbs | ¹ We max. lbs | Hardness | | |
| MC4525-0-HT | 3,275 | 2,717,177 | 1,035,536 | 15 | 59 | -0 | 4 | 2.49 |
| MC4525-1-HT | 3,275 | 2,717,177 | 1,035,536 | 50 | 200 | -1 | 4 | 2.49 |
| MC4525-2-HT | 3,275 | 2,717,177 | 1,035,536 | 170 | 680 | -2 | 4 | 2.49 |
| MC4525-3-HT | 3,275 | 2,717,177 | 1,035,536 | 575 | 2,300 | -3 | 4 | 2.49 |
| MC4525-4-HT | 3,275 | 2,717,177 | 1,035,536 | 1,950 | 7,800 | -4 | 4 | 2.49 |
| MC4550-0-HT | 6,550 | 2,841,087 | 1,079,790 | 28 | 119 | -0 | 3 | 3.00 |
| MC4550-1-HT | 6,550 | 2,841,087 | 1,079,790 | 100 | 400 | -1 | 3 | 3.00 |
| MC4550-2-HT | 6,550 | 2,841,087 | 1,079,790 | 340 | 1,360 | -2 | 3 | 3.00 |
| MC4550-3-HT | 6,550 | 2,841,087 | 1,079,790 | 1,150 | 4,600 | -3 | 3 | 3.00 |
| MC4550-4-HT | 6,550 | 2,841,087 | 1,079,790 | 3,900 | 15,600 | -4 | 3 | 3.00 |

¹ The effective weight range limits can be raised or lowered to special order.
² For applications with higher side load angles please contact ACE.

MC64-HT

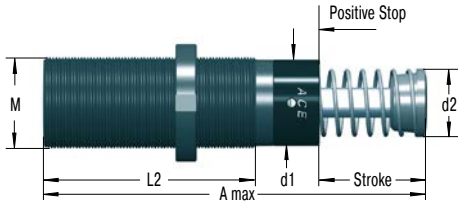

Product available for UNF and metric thread (for metric add suffix -M from part number)

250-0042 Locking Ring

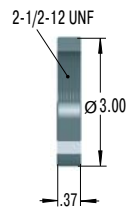

250-0028 Square Flange

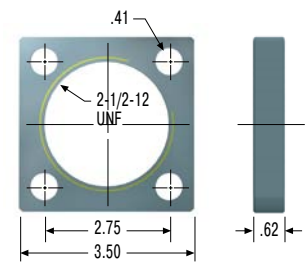

250-0301 Locking Ring

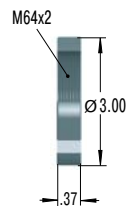

250-0302 Square Flange

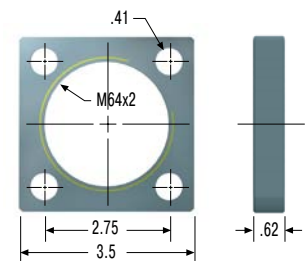

The calculation and selection of the most suitable damper should be carried out or be approved by ACE.

Complete details required when ordering

- Load to be decelerated: W (lbs)
- Impact velocity: v (ft/s)
- Propelling force: F (lbs)
- Operating cycles per hour: c (/hr)
- Number of absorbers in parallel: n
- Ambient temperature: °F

Ordering Example

Self-Compensating **MC6450M-2-HT**
 64 for 2-1/2-12 UNF or M64 threads
 Stroke 1.91" (50 mm)
 Metric Thread
 (omitted when using thread UNF 2-1/2-12)
 Effective Weight Range Version
 HT = Version for High Temperature Use

Dimensions

| TYPES | Stroke inch | A max. inch | d1 inch | d2 inch | L2 inch | M |
|------------|----------------|----------------|------------|------------|------------|----------------------|
| MC6450-HT | 1.91 | 8.85 | 2.37 | 1.90 | 5.5 | 2-1/2-12 UNF / M64x2 |
| MC64100-HT | 3.91 | 12.85 | 2.37 | 1.90 | 7.5 | 2-1/2-12 UNF / M64x2 |

Performance

| TYPES | Max. Energy Capacity | | | Effective Weight | | | Side Load Angle max. ° | Weight lbs |
|--------------|--------------------------------|-------------------------------------|--------------------------------------|-----------------------------|-----------------------------|----------|---------------------------|---------------|
| | E ₃ in-lbs/cycle | E ₄ at 68 °F in-lbs/h | E ₄ at 212 °F in-lbs/h | ¹ We min. lbs | ¹ We max. lbs | Hardness | | |
| MC6450-0-HT | 16,550 | 3,708,460 | 1,407,267 | 308 | 1,190 | -0 | 4 | 6.39 |
| MC6450-1-HT | 16,550 | 3,708,460 | 1,407,267 | 300 | 1,200 | -1 | 4 | 6.39 |
| MC6450-2-HT | 16,550 | 3,708,460 | 1,407,267 | 1,020 | 4,080 | -2 | 4 | 6.39 |
| MC6450-3-HT | 16,550 | 3,708,460 | 1,407,267 | 3,460 | 13,480 | -3 | 4 | 6.39 |
| MC6450-4-HT | 16,550 | 3,708,460 | 1,407,267 | 11,700 | 46,800 | -4 | 4 | 6.39 |
| MC64100-0-HT | 33,000 | 4,867,907 | 1,770,148 | 154 | 617 | -0 | 3 | 8.16 |
| MC64100-1-HT | 33,000 | 4,867,907 | 1,770,148 | 600 | 2,400 | -1 | 3 | 8.16 |
| MC64100-2-HT | 33,000 | 4,867,907 | 1,770,148 | 2,040 | 8,160 | -2 | 3 | 8.16 |
| MC64100-3-HT | 33,000 | 4,867,907 | 1,770,148 | 6,920 | 27,680 | -3 | 3 | 8.16 |
| MC64100-4-HT | 33,000 | 4,867,907 | 1,770,148 | 23,400 | 93,600 | -4 | 3 | 8.16 |

¹ The effective weight range limits can be raised or lowered to special order.
² For applications with higher side load angles please contact ACE.

MC33-LT to MC64-LT

Extreme temperature and high cycle applications

Self-Compensating

Energy capacity 1,505 in-lbs/Cycle to 50,000 in-lbs/Cycle

Stroke 0.91 in to 5.91 in

Greater application range: just like all MAGNUM types from the product family MC33 to MC64, the LT (low temperature) industrial shock absorbers are also made from one solid piece. They use special seals and fluids. This means that these versions can even be used at extreme temperatures of -58 °F to +151 °F in order to safely and reliably damp masses and absorb 100 % of the kinetic energy.

These ready-to-install machine elements are recommended even under the most unfavorable conditions. Additional benefits are their robust, innovative sealing technology, high energy absorption in a compact design, fixed positive stop and a wide damping range. Self-compensating shock absorbers react to changing energy conditions, without adjustment.

Designed for use in extreme temperature ranges, these self-compensating industrial shock absorbers are suitable almost anywhere in plant, industrial, automation and machine engineering.

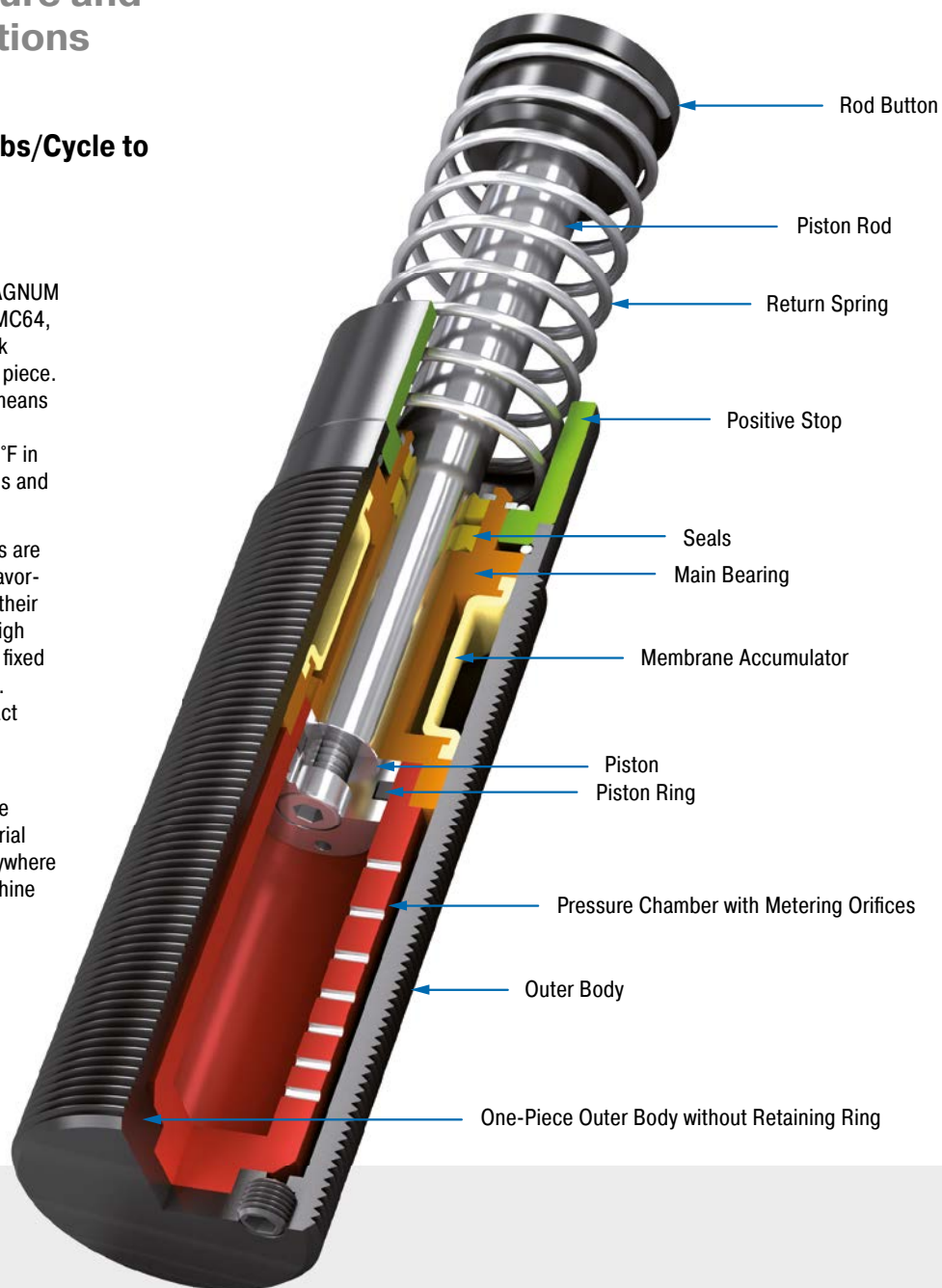

Technical Data

Energy capacity: 1,505 in-lbs/Cycle to 50,000 in-lbs/Cycle

Impact velocity range: 0.5 ft/sec to 16.5 ft/sec. Other speeds on request.

Operating temperature range: -58 °F to 150 °F

Mounting: In any position

Positive stop: Integrated

Material: Outer body: Nitride hardened steel; Piston rod: Hard chrome plated steel; Rod end button: Hardened steel and corrosion-resistant coating; Return spring: Zinc plated or plastic-coated steel; Accessories: Steel with black oxide finish or nitride hardened

Damping medium: Low temperature hydraulic oil

Application field: Linear slides, Swivel units, Turntables, Machines and plants, Tool machines, Machining centers, Z-axes

Note: A noise reduction of 3 dB to 7 dB is possible when using the special impact button.

Safety information: External materials in the surrounding area can attack the seal components and lead to a shorter service life. Please contact ACE for appropriate solution suggestions. Do not paint the shock absorbers due to heat emission.

On request: Nickel-plated, increased corrosion protection, mounting inside air cylinders or other special options are available on request. Adjustable HT and LT shock absorbers.

MC33-LT

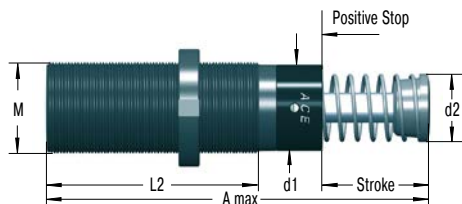

Product available for UNF and metric thread (for metric add suffix -M from part number)
M33x1.5, M36x1.5 and M42x1.5 also available to order

250-0038 Locking Ring

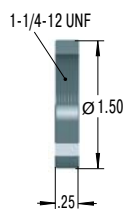

250-0016 Rectangular Flange

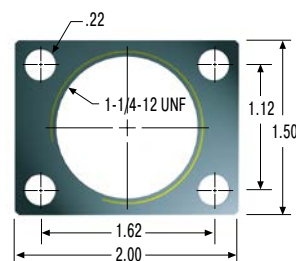

250-0292 Locking Ring

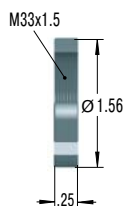

250-0293 Rectangular Flange

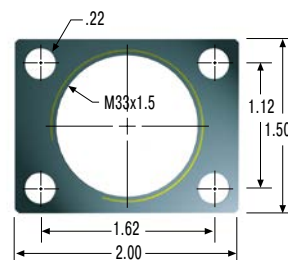

The calculation and selection of the most suitable damper should be carried out or be approved by ACE.

Complete details required when ordering

- Load to be decelerated: W (lbs)
- Impact velocity: v (ft/s)
- Propelling force: F (lbs)
- Operating cycles per hour: c (/hr)
- Number of absorbers in parallel: n
- Ambient temperature: °F

Ordering Example

Self-Compensating _____ **MC3325M-3-LT**
 33 for 1-1/4-12 UNF or M33 threads _____
 Stroke 0.91" (25 mm) _____
 Metric Thread _____
 (omitted when using thread UNF 1-1/4-12)
 Effective Weight Range Version _____
 LT = Version for High Temperature Use _____

Dimensions

| TYPES | Stroke inch | A max. inch | d1 inch | d2 inch | L2 inch | M |
|-----------|----------------|----------------|------------|------------|------------|------------------------|
| MC3325-LT | 0.91 | 5.44 | 1.15 | 1.00 | 3.25 | 1-1/4-12 UNF / M33x1.5 |
| MC3350-LT | 1.91 | 7.44 | 1.15 | 1.00 | 4.25 | 1-1/4-12 UNF / M33x1.5 |

Performance

| TYPES | Max. Energy Capacity | | Effective Weight | | | Return Time s | Side Load Angle max. ° | Weight lbs |
|-------------|--------------------------------|----------------------------|-----------------------------|-----------------------------|----------|------------------|---------------------------|---------------|
| | E ₃ in-lbs/cycle | E ₄ in-lbs/h | ¹ We min. lbs | ¹ We max. lbs | Hardness | | | |
| MC3325-0-LT | 1,505 | 670,000 | 6 | 24 | -0 | 0.08 | 4 | 1.12 |
| MC3325-1-LT | 1,505 | 670,000 | 20 | 80 | -1 | 0.08 | 4 | 1.12 |
| MC3325-2-LT | 1,505 | 670,000 | 68 | 272 | -2 | 0.08 | 4 | 1.12 |
| MC3325-3-LT | 1,505 | 670,000 | 230 | 920 | -3 | 0.08 | 4 | 1.12 |
| MC3325-4-LT | 1,505 | 670,000 | 780 | 3,120 | -4 | 0.08 | 4 | 1.12 |
| MC3350-0-LT | 2,920 | 760,000 | 11 | 48 | -0 | 0.16 | 3 | 1.39 |
| MC3350-1-LT | 2,920 | 760,000 | 40 | 160 | -1 | 0.16 | 3 | 1.39 |
| MC3350-2-LT | 2,920 | 760,000 | 136 | 544 | -2 | 0.16 | 3 | 1.39 |
| MC3350-3-LT | 2,920 | 760,000 | 460 | 1,840 | -3 | 0.16 | 3 | 1.39 |
| MC3350-4-LT | 2,920 | 760,000 | 1,560 | 6,240 | -4 | 0.16 | 3 | 1.39 |

¹ The effective weight range limits can be raised or lowered to special order.

² at -58 °F

³ For applications with higher side load angles please contact ACE.

Products for UNF and metric thread available



Self-Compensating

MC45-LT

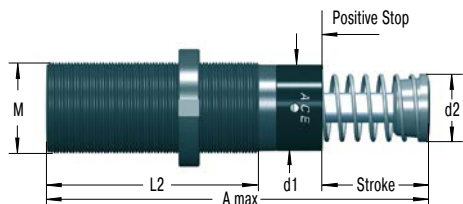

Product available for UNF and metric thread (for metric add suffix -M from part number)

250-0041 Locking Ring

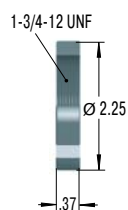

250-0023 Square Flange

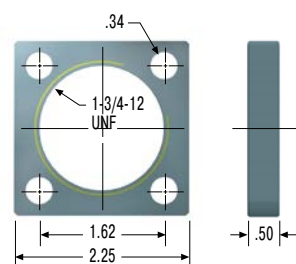

250-0024 Rectangular Flange

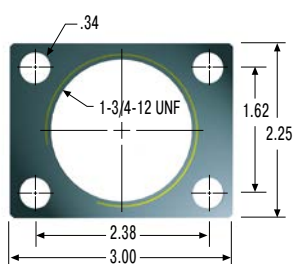

250-0299 Rectangular Flange

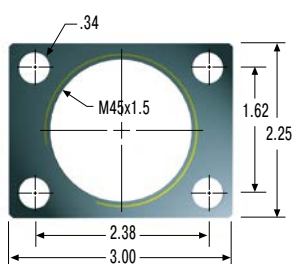

250-0297 Locking Ring

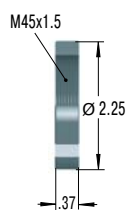

250-0298 Square Flange

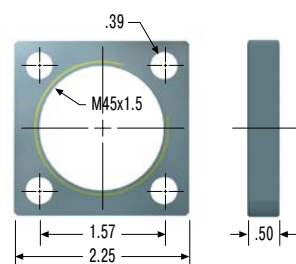

The calculation and selection of the most suitable damper should be carried out or be approved by ACE.

Complete details required when ordering

- Load to be decelerated: W (lbs)
- Impact velocity: v (ft/s)
- Propelling force: F (lbs)
- Operating cycles per hour: c (/hr)
- Number of absorbers in parallel: n
- Ambient temperature: °F

Ordering Example

Self-Compensating _____ **MC4525M-3-LT**
 45 for 1-3/4-12 UNF or M45 threads _____
 Stroke 0.91" (25 mm) _____
 Metric Thread _____
 (omitted when using thread UNF 1-3/4-12)
 Effective Weight Range Version _____
 LT = Version for High Temperature Use _____

Dimensions

| TYPES | Stroke inch | A max. inch | d1 inch | d2 inch | L2 inch | M |
|-----------|----------------|----------------|------------|------------|------------|------------------------|
| MC4525-LT | 0.91 | 5.69 | 1.65 | 1.38 | 3.72 | 1-3/4-12 UNF / M45x1.5 |
| MC4550-LT | 1.91 | 7.69 | 1.65 | 1.38 | 4.72 | 1-3/4-12 UNF / M45x1.5 |
| MC4575-LT | 2.91 | 9.69 | 1.65 | 1.38 | 5.72 | 1-3/4-12 UNF / M45x1.5 |

Performance

| TYPES | Max. Energy Capacity | | Effective Weight | | Hardness | Return Time s | Side Load Angle max. ° | Weight lbs |
|-------------|--------------------------------|----------------------------|------------------|----------------|----------|------------------|---------------------------|---------------|
| | E ₃ in-lbs/cycle | E ₄ in-lbs/h | We min. lbs | We max. lbs | | | | |
| MC4525-0-LT | 3,275 | 950,000 | 15 | 59 | -0 | 0.08 | 4 | 2.49 |
| MC4525-1-LT | 3,275 | 950,000 | 50 | 200 | -1 | 0.08 | 4 | 2.49 |
| MC4525-2-LT | 3,275 | 950,000 | 170 | 680 | -2 | 0.08 | 4 | 2.49 |
| MC4525-3-LT | 3,275 | 950,000 | 575 | 2,300 | -3 | 0.08 | 4 | 2.49 |
| MC4525-4-LT | 3,275 | 950,000 | 1,950 | 7,800 | -4 | 0.08 | 4 | 2.49 |
| MC4550-0-LT | 6,550 | 1,000,000 | 28 | 119 | -0 | 0.16 | 3 | 3.00 |
| MC4550-1-LT | 6,550 | 1,000,000 | 100 | 400 | -1 | 0.16 | 3 | 3.00 |
| MC4550-2-LT | 6,550 | 1,000,000 | 340 | 1,360 | -2 | 0.16 | 3 | 3.00 |
| MC4550-3-LT | 6,550 | 1,000,000 | 1,150 | 4,600 | -3 | 0.16 | 3 | 3.00 |
| MC4550-4-LT | 6,550 | 1,000,000 | 3,900 | 15,600 | -4 | 0.16 | 3 | 3.00 |
| MC4575-0-LT | 10,000 | 1,300,000 | 44 | 176 | -0 | 0.24 | 2 | 3.51 |
| MC4575-1-LT | 10,000 | 1,300,000 | 150 | 600 | -1 | 0.24 | 2 | 3.51 |
| MC4575-2-LT | 10,000 | 1,300,000 | 510 | 2,040 | -2 | 0.24 | 2 | 3.51 |
| MC4575-3-LT | 10,000 | 1,300,000 | 1,370 | 6,920 | -3 | 0.24 | 2 | 3.51 |
| MC4575-4-LT | 10,000 | 1,300,000 | 5,850 | 23,400 | -4 | 0.24 | 2 | 3.51 |

¹ The effective weight range limits can be raised or lowered to special order.
² at -58 °F
³ For applications with higher side load angles please contact ACE.

Issue 04.2018 - Specifications subject to change

MC64-LT

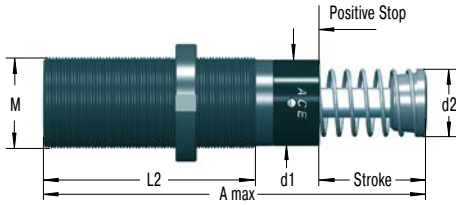

Product available for UNF and metric thread (for metric add suffix -M from part number)
 5.91" stroke model does not include stop collar.
 Positive stop is provided by the rod button (Ø 2.36") and a stop block.

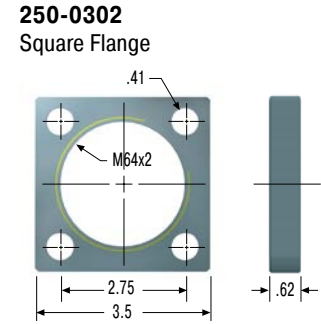
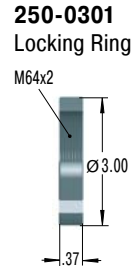
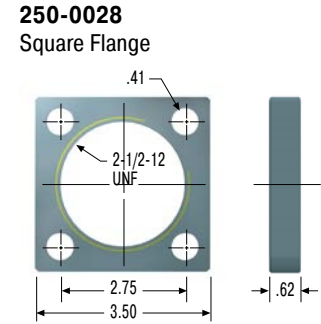
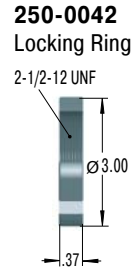

The calculation and selection of the most suitable damper should be carried out or be approved by ACE.

Complete details required when ordering

- Load to be decelerated: W (lbs)
- Impact velocity: v (ft/s)
- Propelling force: F (lbs)
- Operating cycles per hour: c (/hr)
- Number of absorbers in parallel: n
- Ambient temperature: °F

Ordering Example

Self-Compensating _____ **MC6450M-3-LT**
 64 for 2-1/2-12 UNF or M64 threads _____
 Stroke 1.91" (50 mm) _____
 Metric Thread _____
 (omitted when using thread UNF 2-1/2-12)
 Effective Weight Range Version _____
 LT = Version for High Temperature Use _____

Dimensions

| TYPES | Stroke inch | A max. inch | d1 inch | d2 inch | L2 inch | M |
|------------|----------------|----------------|------------|------------|------------|----------------------|
| MC6450-LT | 1.91 | 8.85 | 2.37 | 1.90 | 5.5 | 2-1/2-12 UNF / M64x2 |
| MC64100-LT | 3.91 | 12.85 | 2.37 | 1.90 | 7.5 | 2-1/2-12 UNF / M64x2 |
| MC64150-LT | 5.91 | 17.73 | 2.37 | 1.90 | 9.5 | 2-1/2-12 UNF / M64x2 |

Performance

| TYPES | Max. Energy Capacity | | Effective Weight | | Hardness | Return Time s | Side Load Angle max. ° | Weight lbs |
|--------------|--------------------------------|----------------------------|-----------------------------|-----------------------------|----------|------------------|---------------------------|---------------|
| | E ₃ in-lbs/cycle | E ₄ in-lbs/h | ¹ We min. lbs | ¹ We max. lbs | | | | |
| MC6450-0-LT | 16,551 | 1,300,000 | 308 | 1,190 | -0 | 0.24 | 4 | 6.39 |
| MC6450-1-LT | 16,551 | 1,300,000 | 300 | 1,200 | -1 | 0.24 | 4 | 6.39 |
| MC6450-2-LT | 16,551 | 1,300,000 | 1,020 | 4,080 | -2 | 0.24 | 4 | 6.39 |
| MC6450-3-LT | 16,551 | 1,300,000 | 3,460 | 13,480 | -3 | 0.24 | 4 | 6.39 |
| MC6450-4-LT | 16,551 | 1,300,000 | 11,700 | 46,800 | -4 | 0.24 | 4 | 6.39 |
| MC64100-0-LT | 33,013 | 1,700,000 | 154 | 617 | -0 | 0.68 | 3 | 8.16 |
| MC64100-1-LT | 33,013 | 1,700,000 | 600 | 2,400 | -1 | 0.60 | 3 | 8.16 |
| MC64100-2-LT | 33,013 | 1,700,000 | 2,040 | 8,160 | -2 | 0.68 | 3 | 8.16 |
| MC64100-3-LT | 33,013 | 1,700,000 | 6,920 | 27,680 | -3 | 0.68 | 3 | 8.16 |
| MC64100-4-LT | 33,013 | 1,700,000 | 23,400 | 93,600 | -4 | 0.68 | 3 | 8.16 |
| MC64150-0-LT | 50,007 | 2,200,000 | 220 | 1,014 | -0 | 0.96 | 2 | 11.25 |
| MC64150-1-LT | 50,007 | 2,200,000 | 900 | 3,600 | -1 | 0.96 | 2 | 11.25 |
| MC64150-2-LT | 50,007 | 2,200,000 | 3,060 | 12,240 | -2 | 0.96 | 2 | 11.25 |
| MC64150-3-LT | 50,007 | 2,200,000 | 10,380 | 41,520 | -3 | 0.96 | 2 | 11.25 |
| MC64150-4-LT | 50,007 | 2,200,000 | 35,100 | 140,400 | -4 | 0.96 | 2 | 11.25 |

¹ The effective weight range limits can be raised or lowered to special order.

² at -58 °F

³ For applications with higher side load angles please contact ACE.

SC33 to SC45

Piston tube design for maximum energy absorption

Self-Compensating, Piston Tube Technology

Energy capacity 1,372 In-lbs/Cycle to

6,019 in-lbs/Cycle

Stroke 0.91 in to 1.91 in

True performers: The SC33 to SC45 absorber models are strong and durable by combining the proven sealing technology from the MAGNUM range including membrane accumulator with the well-known piston tube technology from the SC² family. We increase the oil volume to ensure the maximum effective weights. Short stroke lengths of .98" to 1.96" deliver shorter braking times in combination with high energy absorption.

These dampers safely and reliably decelerate rotary movements without unwanted recoil effects. Installation close to the pivot point is possible. ACE's generation of piston tube manage low impact speeds with ease. Self-compensating shock absorbers react to changing energy conditions, without adjustment.

These self-compensating industrial shock absorbers can be relied on in industrial, automation and machine engineering. They are used in pivot units, rotary tables, robot arms or integrated wherever deceleration is needed.

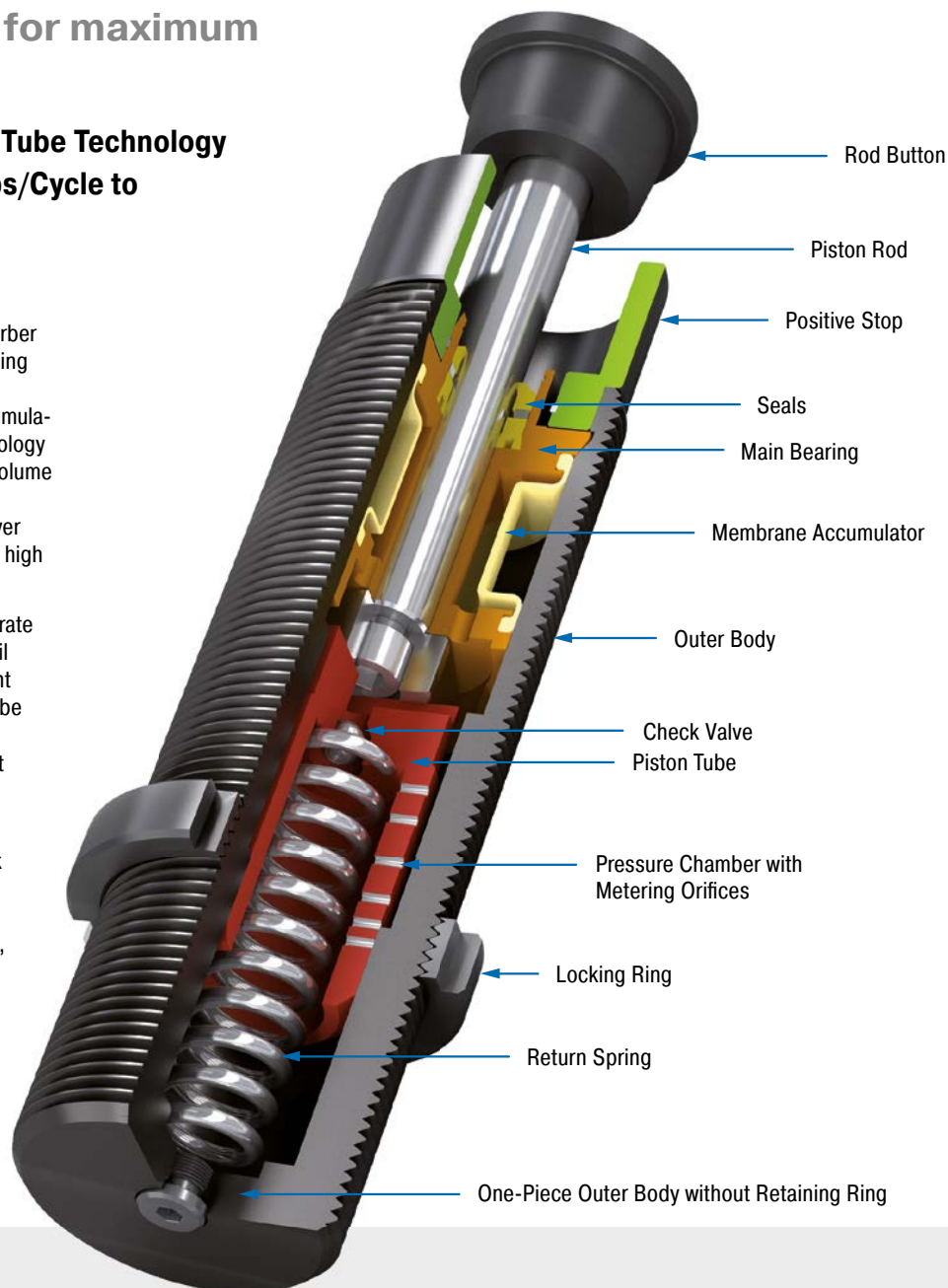

Technical Data

Energy capacity: 1,372 In-lbs/Cycle to 6,019 in-lbs/Cycle

Impact velocity range: 0.66 ft/sec to 1.51 ft/sec. Other speeds on request.

Operating temperature range: 10 °F to 150 °F. Other temperatures on request.

Mounting: In any position

Positive stop: Integrated

Material: Outer body: Nitride hardened steel; Piston rod: Hard chrome plated steel; Rod end button: Hardened steel and corrosion-resistant coating; Accessories: Steel with black oxide finish or nitride hardened

Damping medium: Low temperature hydraulic oil

Application field: Turntables, Swivel units, Robot arms, Linear slides, Pneumatic cylinders, Handling modules, Machines and plants, Finishing and processing centers

Note: A noise reduction of 3 dB to 7 dB is possible when using the special impact button.

Safety information: External materials in the surrounding area can attack the seal components and lead to a shorter service life. Please contact ACE for appropriate solution suggestions. Do not paint the shock absorbers due to heat emission.

On request: Special oils, mounting inside air cylinders or other special options are available on request.

SC33

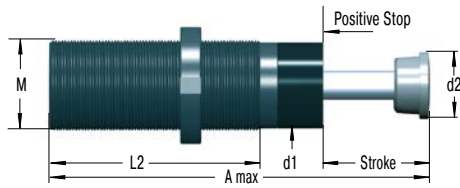

Product available for UNF and metric thread (for metric add suffix -M from part number)

250-0038 Locking Ring

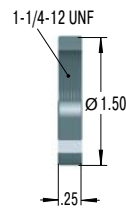

250-0016 Rectangular Flange

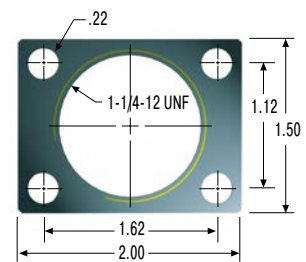

250-0292 Locking Ring

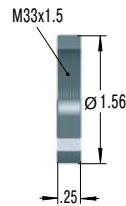

250-0293 Rectangular Flange

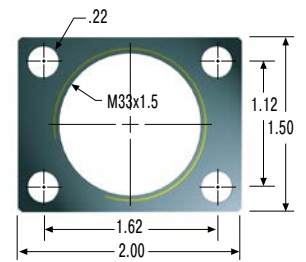

The calculation and selection of the most suitable damper should be carried out or be approved by ACE.

Ordering Example

Self-Compensating **SC3325M-5**
 33 for 1-1/4-12 UNF or M33 threads
 Stroke 0.98" (25 mm)
 Metric Thread
 (omitted when using thread UNF 1 1/4-12)
 Effective Weight Range Version

Dimensions

| TYPES | Stroke inch | A max. inch | d1 inch | d2 inch | L2 inch | M |
|--------|----------------|----------------|------------|------------|------------|------------------------|
| SC3325 | 0.91 | 7.01 | 1.18 | 1.00 | 4.80 | 1-1/4-12 UNF / M33x1.5 |
| SC3350 | 1.91 | 10.00 | 1.18 | 1.00 | 6.81 | 1-1/4-12 UNF / M33x1.5 |

Performance

| TYPES | Max. Energy Capacity | | Effective Weight | | | Return Force min. lbs | Return Force max. lbs | Return Time s | Side Load Angle max. ° | Weight lbs |
|----------|--------------------------------|----------------------------|-----------------------------|-----------------------------|----------|-----------------------------|-----------------------------|------------------|------------------------------|---------------|
| | E ₃ in-lbs/cycle | E ₄ in-lbs/h | ¹ We min. lbs | ¹ We max. lbs | Hardness | | | | | |
| SC3325-5 | 1,372 | 663,806 | 2,998 | 5,999 | -5 | 9.89 | 20.01 | 0.75 | 4 | 1.50 |
| SC3325-6 | 1,372 | 663,806 | 5,512 | 12,000 | -6 | 9.89 | 20.01 | 0.75 | 4 | 1.50 |
| SC3325-7 | 1,372 | 663,806 | 10,999 | 19,698 | -7 | 9.89 | 20.01 | 0.75 | 4 | 1.50 |
| SC3325-8 | 1,372 | 663,806 | 18,999 | 29,998 | -8 | 9.89 | 20.01 | 0.75 | 4 | 1.50 |
| SC3350-5 | 2,744 | 752,313 | 5,999 | 11,001 | -5 | 11.47 | 28.10 | 0.90 | 3 | 2.03 |
| SC3350-6 | 2,744 | 752,313 | 10,000 | 22,002 | -6 | 11.47 | 28.10 | 0.90 | 3 | 2.03 |

¹ The effective weight range limits can be raised or lowered to special order.

² For applications with higher side load angles please contact ACE.

Self-Compensating, Piston Tube Technology

SC45

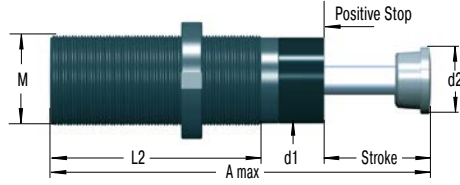

Product available for UNF and metric thread (for metric add suffix -M from part number)

250-0041 Locking Ring

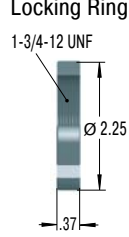

250-0024 Rectangular Flange

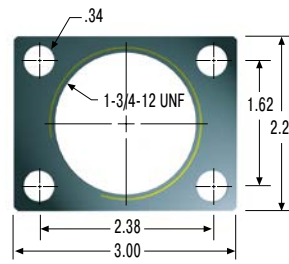

250-0023 Square Flange

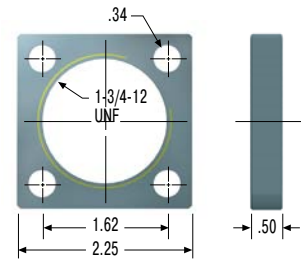

250-0297 Locking Ring

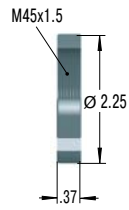

250-0299 Rectangular Flange

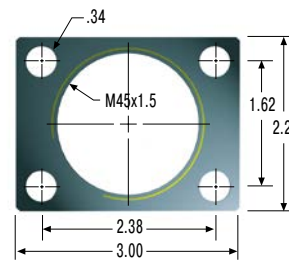

250-0298 Square Flange

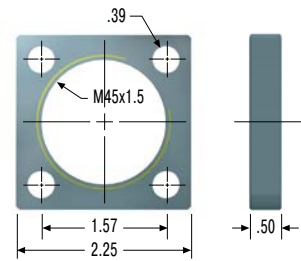

The calculation and selection of the most suitable damper should be carried out or be approved by ACE.

Ordering Example

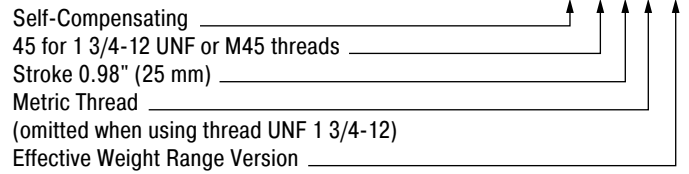

Dimensions

| TYPES | Stroke inch | A max. inch | d1 inch | d2 inch | L2 inch | M |
|--------|----------------|----------------|------------|------------|------------|------------------------|
| SC4525 | 0.91 | 7.44 | 1.65 | 1.38 | 5.47 | 1-3/4-12 UNF / M45x1.5 |
| SC4550 | 1.91 | 10.43 | 1.65 | 1.38 | 7.48 | 1-3/4-12 UNF / M45x1.5 |

Performance

| TYPES | Max. Energy Capacity | | Effective Weight | | | Return Force min. lbs | Return Force max. lbs | Return Time s | Side Load Angle max. ° | Weight lbs |
|----------|--------------------------------|----------------------------|-----------------------------|-----------------------------|----------|-----------------------------|-----------------------------|------------------|------------------------------|---------------|
| | E ₃ in-lbs/cycle | E ₄ in-lbs/h | ¹ We min. lbs | ¹ We max. lbs | Hardness | | | | | |
| SC4525-5 | 3,009 | 947,029 | 7,496 | 14,991 | -5 | 15.06 | 23.38 | 0.8 | 4 | 3.15 |
| SC4525-6 | 3,009 | 947,029 | 13,999 | 29,983 | -6 | 15.06 | 23.38 | 0.8 | 4 | 3.15 |
| SC4525-7 | 3,009 | 947,029 | 27,999 | 49,999 | -7 | 15.06 | 23.38 | 0.8 | 4 | 3.15 |
| SC4525-8 | 3,009 | 947,029 | 44,998 | 85,980 | -8 | 15.06 | 23.38 | 0.8 | 4 | 3.15 |
| SC4550-5 | 6,019 | 991,283 | 14,991 | 26,998 | -5 | 10.57 | 54.40 | 1.0 | 3 | 4.19 |
| SC4550-6 | 6,019 | 991,283 | 25,992 | 59,498 | -6 | 10.57 | 54.40 | 1.0 | 3 | 4.19 |
| SC4550-7 | 6,019 | 991,283 | 56,998 | 97,499 | -7 | 10.57 | 54.40 | 1.0 | 3 | 4.19 |

¹ The effective weight range limits can be raised or lowered to special order.

² For applications with higher side load angles please contact ACE.



Locate and Eliminate Disturbing Vibration

Vibration isolation

- Free App for iPhone
- Precise 3-axis measurement system
- Simple, understandable menu
- Immediate product recommendations

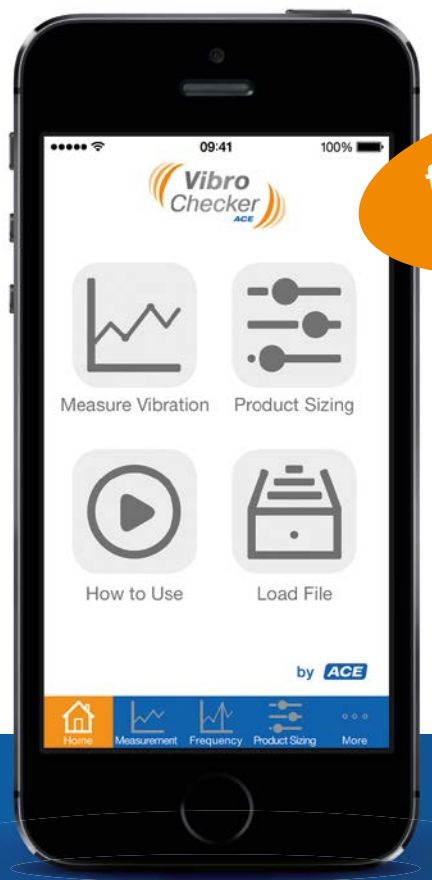

free in the
App Store

Start now.
Free App!



www.vibrochecker.com

MA/ML33 to MA/ML64

High energy absorption and progressive adjustment

Adjustable

Energy capacity 1,505 in-lbs/Cycle to 60,008 in-lbs/Cycle

Stroke 0.91 in to 5.91 in

Adjustable and unique: These industrial shock absorbers from ACE, which can be precisely adjusted both at the front and rear, also contribute towards the success of the MAGNUM range. Equipped with excellent sealing technology, an annealed guide bearing and integrated positive stop, they are robust and durable.

These dampers absorb 50 % more energy than their predecessors but are built even more compactly. The larger range of effective loads also opens up options in design and assembly. This makes the ML range especially suitable for effective weights of 661 lbs. to 1,102,311 lbs. (300 kg to 500,000 kg). These shocks are the best option wherever application data changes and flexibility is required.

These adjustable industrial shock absorbers are used in all areas of industrial, automation and machine engineering, for gantries and integrated in linear carriages or pivoting units.

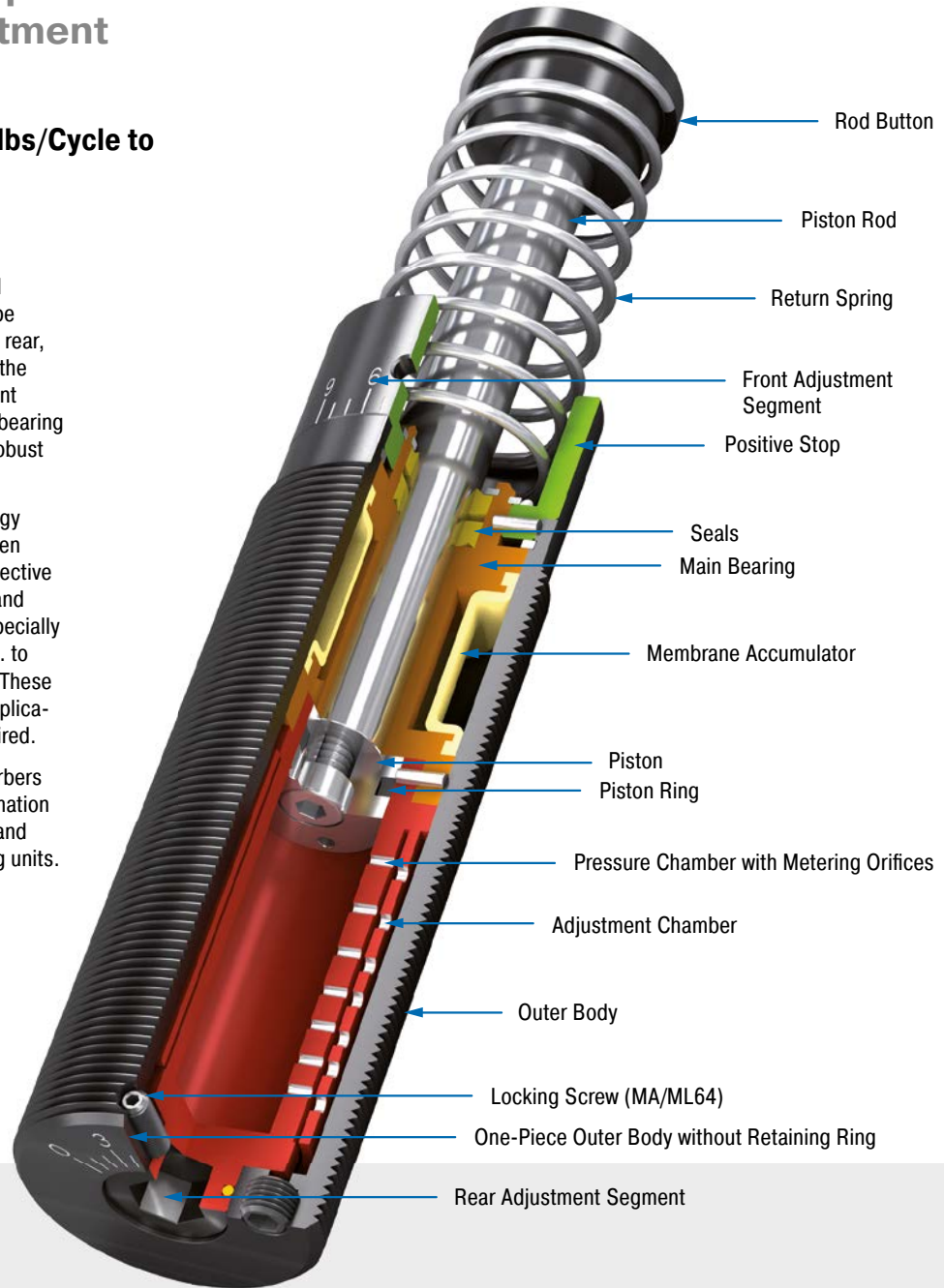

Technical Data

Energy capacity: 1,505 in-lbs/Cycle to 60,008 in-lbs/Cycle

Impact velocity range: MA: 0.5 ft/sec to 16.5 ft/sec. ML: 0.06 ft/sec to 1.5 ft/sec. Other speeds on request.

Operating temperature range: 10 °F to 150 °F. Other temperatures on request.

Mounting: In any position

Positive stop: Integrated

Adjustment: Hard impact at the start of stroke, adjust the ring towards 9 or PLUS. Hard impact at the end of stroke, adjust the ring towards 0 or MINUS.

Material: Outer body: Nitride hardened steel; Piston rod: Hard chrome plated steel; Rod end button: Hardened steel and corrosion-resistant coating; Return spring: Zinc plated or plastic-coated steel; Accessories: Steel with black oxide finish or nitride hardened

Damping medium: Automatic Transmission Fluid (ATF)

Application field: Linear slides, Swivel units, Turntables, Portal systems, Machines and plants, Tool machines, Machining centers, Z-axes, Impact panels, Handling modules

Note: A noise reduction of 3 dB to 7 dB is possible when using the special impact button. For emergency use only applications and for

continuous use (with additional cooling) it is sometimes possible to exceed the published max. capacity ratings. In this case, please consult ACE.

Safety information: External materials in the surrounding area can attack the seal components and lead to a shorter service life. Please contact ACE for appropriate solution suggestions. Do not paint the shock absorbers due to heat emission.

On request: Special oils, nickel-plated, increased corrosion protection, mounting inside air cylinders or other special options are available on request.

MA/ML33



Adjuster

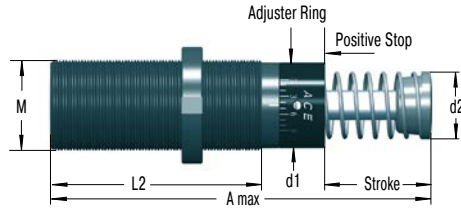

Product available for UNF and metric thread (for metric add suffix -M from part number)

250-0038 Locking Ring

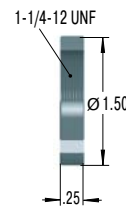

250-0016 Rectangular Flange

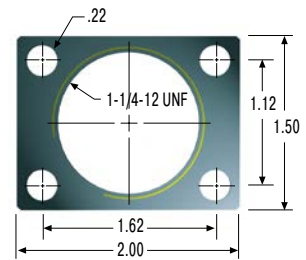

250-0292 Locking Ring

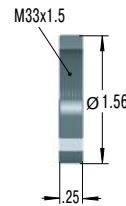

250-0293 Rectangular Flange

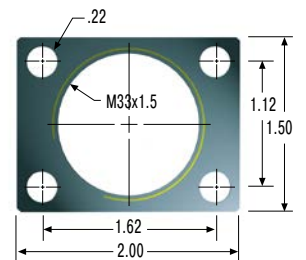

The calculation and selection of the most suitable damper should be carried out or be approved by ACE.

Model Type Prefix

Standard Models

MA: Self-Contained with return spring, adjustable

ML: Self-Contained with return spring, adjustable, for lower impact velocity

Special Models

MAA, MLA: Air/Oil return without return spring. Use only with external air/oil tank.

MAS, MLS: Air/Oil Return with return spring. Use only with external air/oil tank.

MAN, MLN: Self-Contained without return spring

Ordering Example

Adjustable _____ MA/ML3325M
 33 for 1-1/4-12 UNF or M33 threads _____
 Stroke 0.98" (25 mm) _____
 Metric Thread _____
 (omitted when using thread UNF 1 1/4-12)

Dimensions

| TYPES | Stroke inch | A max. inch | d1 inch | d2 inch | L2 inch | M |
|--------|----------------|----------------|------------|------------|------------|------------------------|
| MA3325 | 0.91 | 5.44 | 1.15 | 1.00 | 3.25 | 1-1/4-12 UNF / M33x1.5 |
| ML3325 | 0.91 | 5.44 | 1.15 | 1.00 | 3.25 | 1-1/4-12 UNF / M33x1.5 |
| MA3350 | 1.91 | 7.44 | 1.15 | 1.00 | 4.25 | 1-1/4-12 UNF / M33x1.5 |
| ML3350 | 1.91 | 7.44 | 1.15 | 1.00 | 4.25 | 1-1/4-12 UNF / M33x1.5 |

Performance

| TYPES | Max. Energy Capacity | | | | Effective Weight | | Return Force min. lbs | Return Force max. lbs | Return Time s | Side Load Angle max. ° | Weight lbs |
|--------|---|----------------------------|---|--|-----------------------------|-----------------------------|-----------------------------|-----------------------------|------------------|------------------------------|---------------|
| | ¹ E ₃ in-lbs/cycle | E ₄ in-lbs/h | E ₄ with Air/Oil Tank in-lbs/h | E ₄ with Oil Recirculation in-lbs/h | ² We min. lbs | ² We max. lbs | | | | | |
| MA3325 | 1,900 | 670,000 | 1,100,000 | 1,500,000 | 20 | 3,800 | 10.3 | 19.8 | 0.03 | 4 | 0.99 |
| ML3325 | 1,900 | 670,000 | 1,100,000 | 1,500,000 | 661 | 110,231 | 10.3 | 19.8 | 0.03 | 4 | 0.99 |
| MA3350 | 3,800 | 760,000 | 1,200,000 | 1,600,000 | 28 | 5,400 | 9.9 | 30.3 | 0.06 | 3 | 1.19 |
| ML3350 | 3,800 | 760,000 | 1,200,000 | 1,600,000 | 1,102 | 176,370 | 9.9 | 30.3 | 0.06 | 3 | 1.19 |

¹ For emergency use only applications it is sometimes possible to exceed the above ratings. Please consult ACE for further details.

² The effective weight range limits can be raised or lowered to special order.

³ For applications with higher side load angles please contact ACE.

Adjustable

MA/ML45



Adjuster

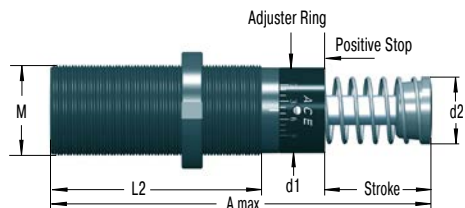

Product available for UNF and metric thread (for metric add suffix -M from part number)

250-0041 Locking Ring

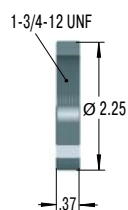

250-0023 Square Flange

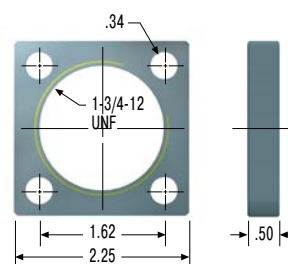

250-0024 Rectangular Flange

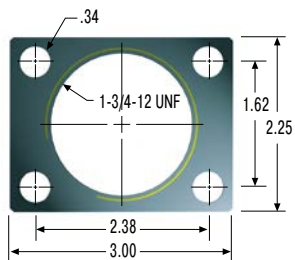

250-0299 Rectangular Flange

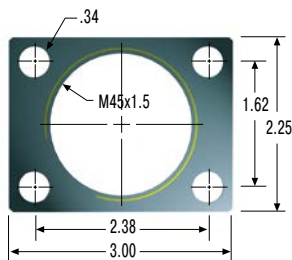

250-0297 Locking Ring

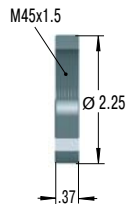

250-0298 Square Flange

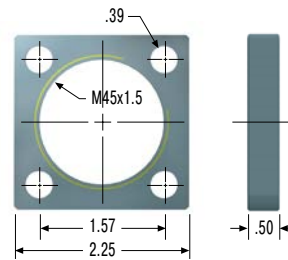

The calculation and selection of the most suitable damper should be carried out or be approved by ACE.

Model Type Prefix

Standard Models

MA: Self-Contained with return spring, adjustable
ML: Self-Contained with return spring, adjustable, for lower impact velocity

Special Models

MAA, MLA: Air/Oil return without return spring. Use only with external air/oil tank.
MAS, MLS: Air/Oil Return with return spring. Use only with external air/oil tank.
MAN, MLN: Self-Contained without return spring

Ordering Example

Adjustable _____ MA/ML4525M
45 for 1-3/4-12 UNF or M45 threads _____
Stroke 0.98" (25 mm) _____
Metric Thread _____
(omitted when using thread UNF 1-3/4-12)

Dimensions

| TYPES | Stroke inch | A max. inch | d1 inch | d2 inch | L2 inch | M |
|--------|----------------|----------------|------------|------------|------------|------------------------|
| MA4525 | 0.91 | 5.69 | 1.65 | 1.38 | 3.72 | 1-3/4-12 UNF / M45x1.5 |
| ML4525 | 0.91 | 5.69 | 1.65 | 1.38 | 3.72 | 1-3/4-12 UNF / M45x1.5 |
| MA4550 | 1.91 | 7.69 | 1.65 | 1.38 | 4.72 | 1-3/4-12 UNF / M45x1.5 |
| ML4550 | 1.91 | 7.69 | 1.65 | 1.38 | 4.72 | 1-3/4-12 UNF / M45x1.5 |
| MA4575 | 2.91 | 9.69 | 1.65 | 1.38 | 5.72 | 1-3/4-12 UNF / M45x1.5 |

Performance

| TYPES | Max. Energy Capacity | | | | Effective Weight | | Return Force | | | Return Time | | Side Load | |
|--------|---|----------------------------|---|--|-----------------------------|-----------------------------|--------------|-------------|------------------|---|---------------|-----------|--|
| | ¹ E ₃ in-lbs/cycle | E ₄ in-lbs/h | E ₄ with Air/Oil Tank in-lbs/h | E ₄ with Oil Recirculation in-lbs/h | ² We min. lbs | ² We max. lbs | min. lbs | max. lbs | Return Time s | ³ Side Load Angle max. ° | Weight lbs | | |
| MA4525 | 3,762 | 950,000 | 1,400,000 | 1,700,000 | 95 | 22,000 | 15.1 | 22.8 | 0.03 | 4 | 2.49 | | |
| ML4525 | 3,762 | 950,000 | 1,400,000 | 1,700,000 | 6,614 | 242,508 | 15.1 | 32.2 | 0.03 | 4 | 2.49 | | |
| MA4550 | 7,523 | 1,000,000 | 1,700,000 | 2,200,000 | 150 | 32,000 | 15.1 | 32.2 | 0.08 | 3 | 3.00 | | |
| ML4550 | 7,523 | 1,000,000 | 1,700,000 | 2,200,000 | 11,023 | 396,832 | 15.1 | 32.2 | 0.08 | 3 | 3.00 | | |
| MA4575 | 11,506 | 1,300,000 | 2,000,000 | 2,500,000 | 155 | 33,000 | 11.7 | 40.3 | 0.11 | 2 | 3.51 | | |

¹ For emergency use only applications it is sometimes possible to exceed the above ratings. Please consult ACE for further details.
² The effective weight range limits can be raised or lowered to special order.
³ For applications with higher side load angles please contact ACE.

MA/ML64

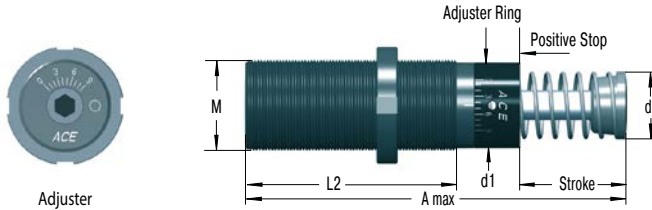

Product available for UNF and metric thread (for metric add suffix -M from part number)
5.91" stroke model does not include stop collar.
Positive stop is provided by the rod button (Ø 2.36") and a stop block.

250-0042 Locking Ring

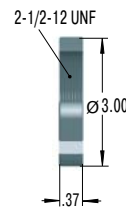

250-0028 Square Flange

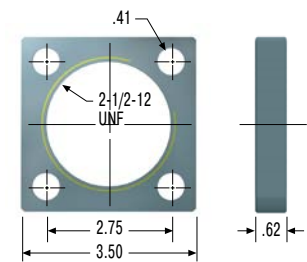

250-0301 Locking Ring

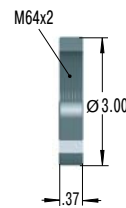

250-0302 Square Flange

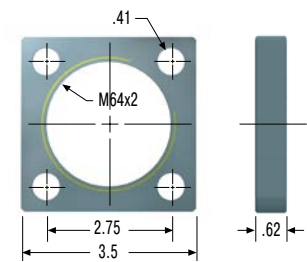

The calculation and selection of the most suitable damper should be carried out or be approved by ACE.

Model Type Prefix

Standard Models

MA: Self-Contained with return spring, adjustable
ML: Self-Contained with return spring, adjustable, for lower impact velocity

Special Models

MAA, MLA: Air/Oil return without return spring. Use only with external air/oil tank.
MAS, MLS: Air/Oil Return with return spring. Use only with external air/oil tank.
MAN, MLN: Self-Contained without return spring

Ordering Example

Adjustable _____ MA/ML6450M
64 for 2-1/2-12 UNF or M64 threads _____
Stroke 1.97" (50 mm) _____
Metric Thread _____
(omitted when using thread UNF 2-1/2-12)

Dimensions

| TYPES | Stroke inch | A max. inch | d1 inch | d2 inch | L2 inch | M |
|---------|----------------|----------------|------------|------------|------------|----------------------|
| ML6425 | 0.91 | 6.85 | 2.37 | 1.90 | 4.5 | 2-1/2-12 UNF / M64x2 |
| MA6450 | 1.91 | 8.85 | 2.37 | 1.90 | 5.5 | 2-1/2-12 UNF / M64x2 |
| ML6450 | 1.91 | 8.85 | 2.37 | 1.90 | 5.5 | 2-1/2-12 UNF / M64x2 |
| MA64100 | 3.91 | 12.85 | 2.37 | 1.90 | 7.5 | 2-1/2-12 UNF / M64x2 |
| MA64150 | 5.91 | 17.73 | 2.37 | 1.90 | 9.5 | 2-1/2-12 UNF / M64x2 |

Performance

| TYPES | Max. Energy Capacity | | | | Effective Weight | | Return Force | | | Return Time | | Side Load | |
|---------|---|----------------------------|---|--|-----------------------------|-----------------------------|--------------|-------------|------|-----------------|---------------|-----------|--|
| | ¹ E ₃ in-lbs/cycle | E ₄ in-lbs/h | E ₄ with Air/Oil Tank in-lbs/h | E ₄ with Oil Recirculation in-lbs/h | ² We min. lbs | ² We max. lbs | min. lbs | max. lbs | s | Angle max. ° | Weight lbs | | |
| ML6425 | 10,046 | 1,100,000 | 2,200,000 | 2,900,000 | 15,432 | 661,386 | 26.7 | 34.9 | 0.06 | 5 | 5.51 | | |
| MA6450 | 20,135 | 1,300,000 | 2,600,000 | 3,400,000 | 480 | 110,000 | 20.1 | 34.9 | 0.12 | 4 | 6.39 | | |
| ML6450 | 20,135 | 1,300,000 | 2,600,000 | 3,400,000 | 24,250 | 1,102,310 | 20.1 | 34.9 | 0.12 | 4 | 6.39 | | |
| MA64100 | 40,005 | 1,700,000 | 3,400,000 | 4,400,000 | 600 | 115,000 | 23.5 | 61.0 | 0.34 | 3 | 8.16 | | |
| MA64150 | 60,008 | 2,200,000 | 4,400,000 | 5,700,000 | 730 | 175,000 | 16.9 | 82.0 | 0.48 | 2 | 11.25 | | |

¹ For emergency use only applications it is sometimes possible to exceed the above ratings. Please consult ACE for further details.

² The effective weight range limits can be raised or lowered to special order.

³ For applications with higher side load angles please contact ACE.

SASL1 1/8

Low velocity and high effective weight range

Adjustable

Energy capacity 8,000 in-lbs/Cycle to 16,000 in-lbs/Cycle

Stroke 1 in to 2 in

Designed for low velocity, high propelling force applications, SASL shock absorbers are a fixed flange product with a built-in square mount.

SASL industrial shock absorbers can be adjusted and precisely adapted to your requirements; they feature an integrated positive stop and are designed to handle effective weights from 16,000 to 48,000 in-lbs. per cycle.

These adjustable shock absorbers are ideal for all areas of industrial automation and machine engineering applications. They are used in linear slides, tool machines, swivel units or wherever deceleration is needed.

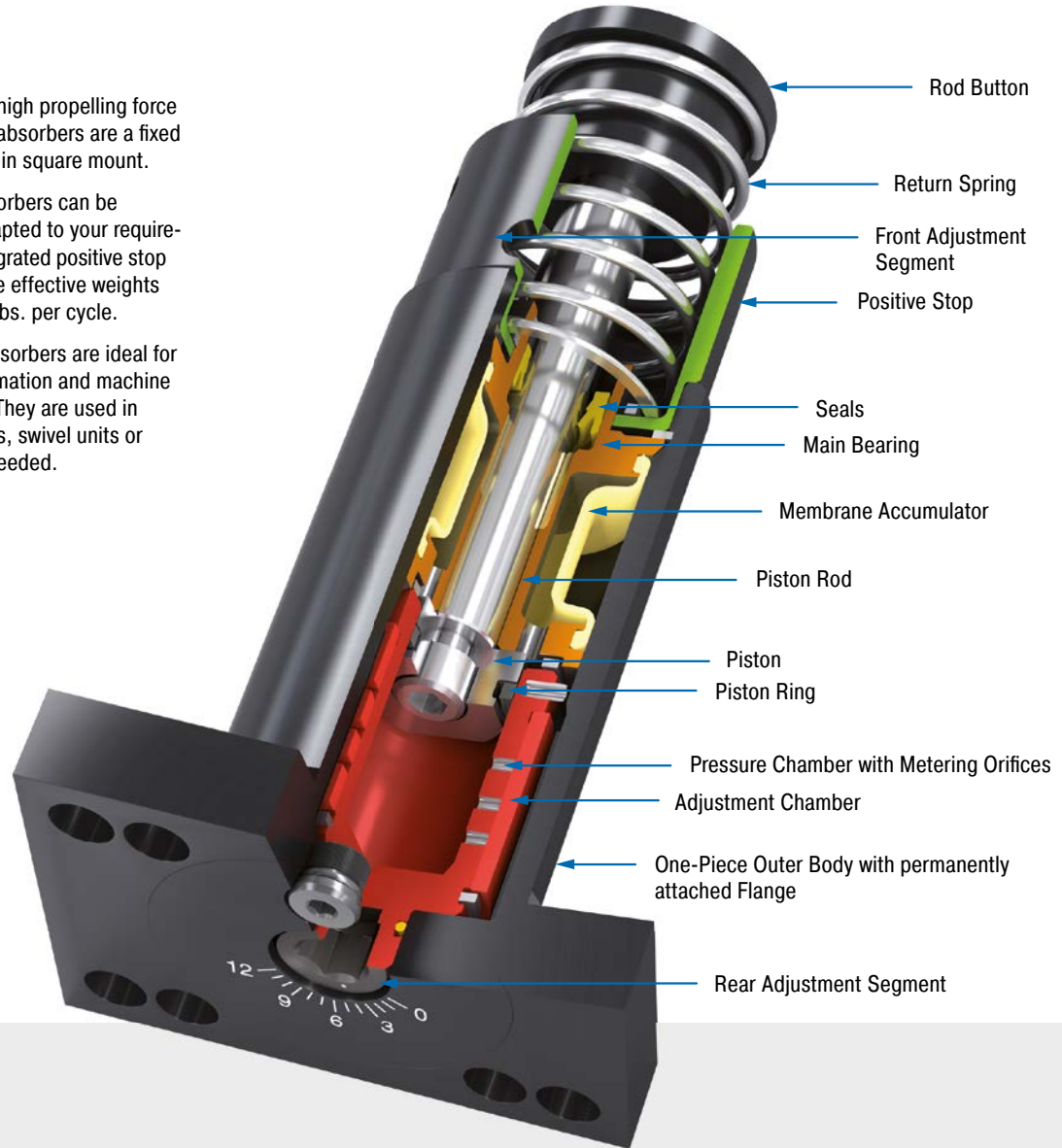

Technical Data

Energy capacity: 8,000 in-lbs/Cycle to 16,000 in-lbs/Cycle

Impact velocity range: 0.25 ft/sec to 2 ft/sec

Operating temperature range: 10 °F to 150 °F

Positive stop: Integrated

Material: Outer body: Nitride hardened steel; Piston rod: Hard chrome plated steel; Rod end button: Hardened steel and corrosion-resistant coating; Return spring: Zinc plated or plastic-coated steel

Damping medium: Automatic Transmission Fluid (ATF)

Application field: Linear slides, Pneumatic cylinders, Swivel units, Handling modules, Machines and plants, Finishing and processing centers, Measuring tables, Tool machines, Machining centers, Locking systems

Safety information: External materials in the surrounding area can attack the seal components and lead to a shorter service life. Please contact ACE for appropriate solution suggestions. Do not paint the shock absorbers due to heat emission.

SASL1 1/8-R Rear Flange

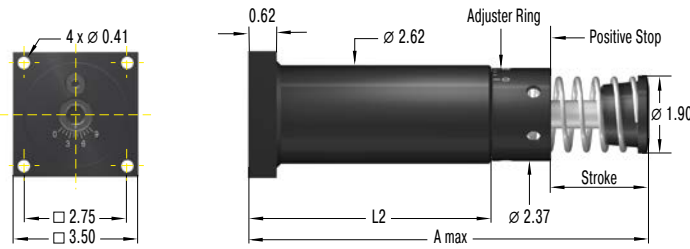

The calculation and selection of the most suitable damper should be carried out or be approved by ACE.

Model Type Prefix

- SASL: Internal accumulator, spring return
- ASLA: Internal accumulator, mechanical return
- ASLS: External accumulator, spring return
- ASL: External accumulator, air or mechanical return

Ordering Example

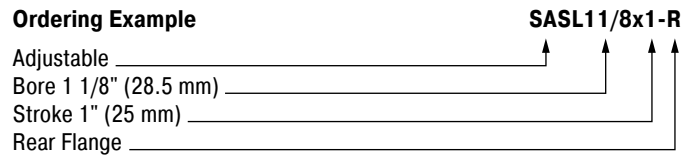

Dimensions

| TYPES | Stroke inch | A max. inch | L2 inch |
|--------------|----------------|----------------|------------|
| SASL11/8X1-R | 0.91 | 6.88 | 3.94 |
| SASL11/8X2-R | 1.91 | 8.85 | 4.88 |

Performance

| TYPES | Max. Energy Capacity | | | Effective Weight | | Weight lbs |
|--------------|--------------------------------|----------------------------|--|-----------------------------|-----------------------------|---------------|
| | E ₃ in-lbs/cycle | E ₄ in-lbs/h | E ₄ with Air/Oil Tank in-lbs/h | ¹ We min. lbs | ¹ We max. lbs | |
| SASL11/8X1-R | 8,000 | 1,250,000 | 2,500,000 | 700 | 700,000 | 8.10 |
| SASL11/8X2-R | 16,000 | 1,500,000 | 3,000,000 | 850 | 1,300,000 | 9.20 |

¹ The effective weight range limits can be raised or lowered to special order.

SALD1/2 to SALD1 1/8

High energy absorption and a wide effective weight range

Adjustable

Energy capacity 1,350 in-lbs/Cycle to 48,000 in-lbs/Cycle

Stroke 1 in to 6 in

Ideal for high-speed moving machines, industrial shock absorbers of the SALD product family feature a built-in external positive stop which prevents damage from bottoming out and a positive work-positioning point.

High energy absorption and a wide damping range lead to huge advantages in practice. Alongside generally more compact designs, these small yet very powerful shock absorbers enable full use of the machine's performance.

These adjustable shock absorbers can be adjusted and precisely adapted to your requirements, making them suitable for a variety of applications in industrial automation and machine engineering applications, especially in automation and gantries.

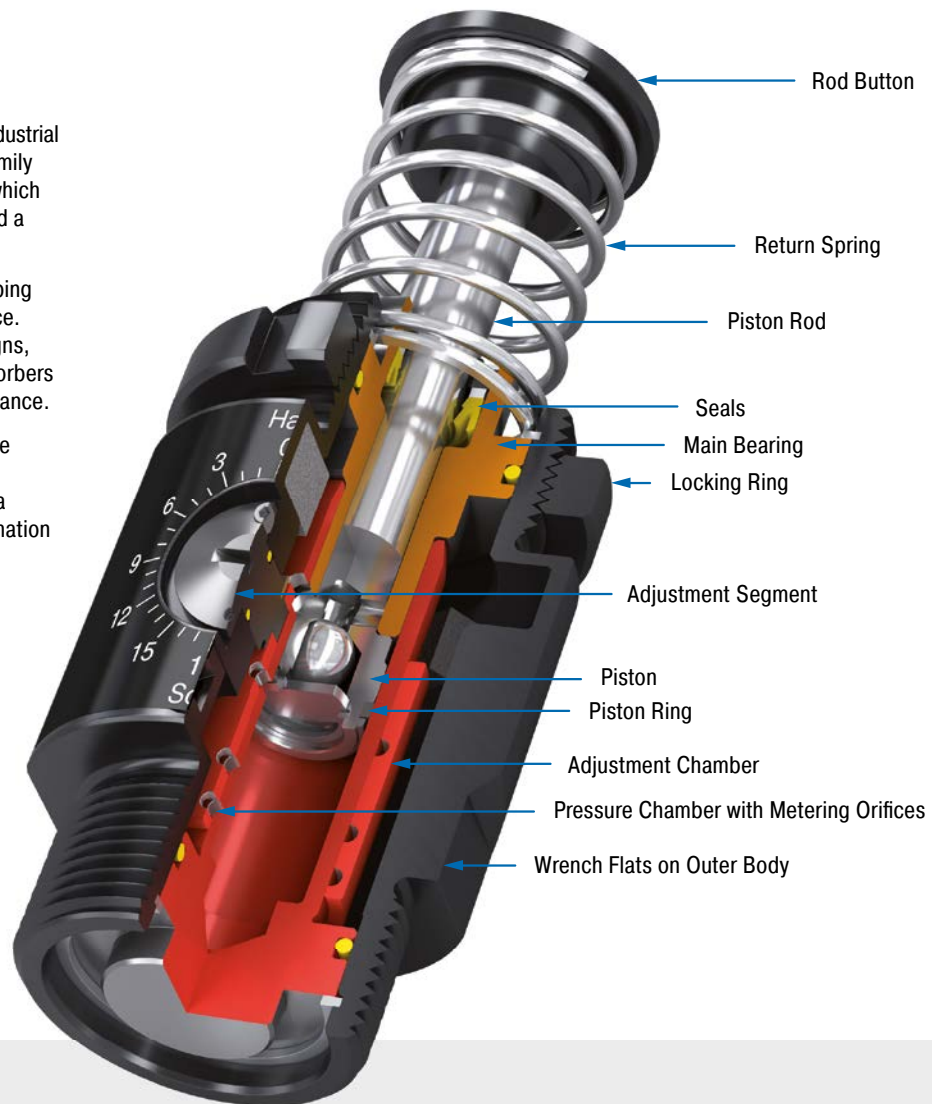

Technical Data

Energy capacity: 1,350 in-lbs/Cycle to 48,000 in-lbs/Cycle

Impact velocity range: 1 ft/sec to 15 ft/sec

Operating temperature range: 10 °F to 150 °F

Mounting: In any position

Positive stop: External

Material: Outer body: Nitride hardened steel; Piston rod: Hard chrome plated steel; Rod end button: Hardened steel and corrosion-resistant coating; Return spring: Zinc plated or plastic-coated steel

Damping medium: Automatic Transmission Fluid (ATF)

Application field: Linear slides, Pneumatic cylinders, Swivel units, Handling modules, Machines and plants, Finishing and processing centers, Measuring tables, Tool machines, Machining centers, Locking systems

Safety information: External materials in the surrounding area can attack the seal components and lead to a shorter service life. Please contact ACE for appropriate solution suggestions. Do not paint the shock absorbers due to heat emission.

SALD1/2-P Primary

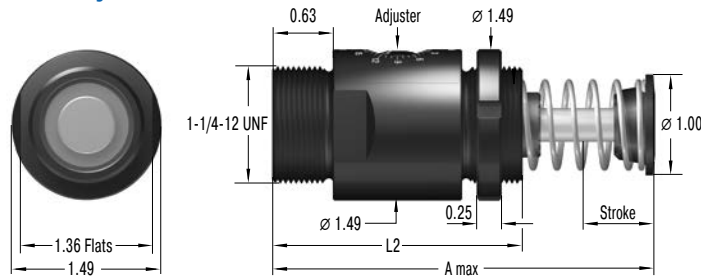

The calculation and selection of the most suitable damper should be carried out or be approved by ACE.

Model Type Prefix

- SALD: Internal accumulator, spring return
- ALDA: Internal accumulator, mechanical return
- ALDS: External accumulator, spring return
- ALD: External accumulator, air or mechanical return

Ordering Example

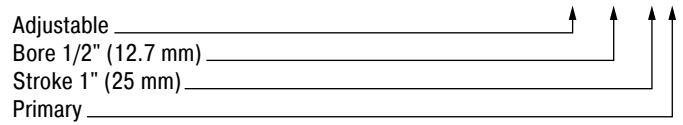

Dimensions

| TYPES | Stroke inch | A max. inch | L2 inch |
|-------------|----------------|----------------|------------|
| SALD1/2X1-P | 0.91 | 5.44 | 3.25 |
| SALD1/2X2-P | 1.91 | 7.44 | 4.25 |

Performance

| TYPES | Max. Energy Capacity | | | Effective Weight | | Weight lbs |
|-------------|--------------------------------|----------------------------|--|-----------------------------|-----------------------------|---------------|
| | E ₃ in-lbs/cycle | E ₄ in-lbs/h | E ₄ with Air/Oil Tank in-lbs/h | ¹ We min. lbs | ¹ We max. lbs | |
| SALD1/2X1-P | 1,350 | 750,000 | 1,300,000 | 10 | 2,700 | 1.50 |
| SALD1/2X2-P | 2,700 | 870,000 | 1,400,000 | 21 | 5,700 | 1.83 |

¹ The effective weight range limits can be raised or lowered to special order.

Adjustable

SALD3/4-P Primary

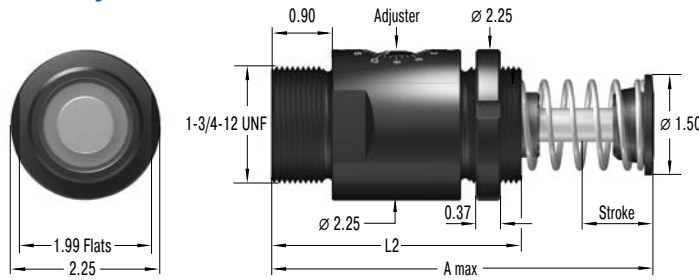

The calculation and selection of the most suitable damper should be carried out or be approved by ACE.

Model Type Prefix

- SALD: Internal accumulator, spring return
- ALDA: Internal accumulator, mechanical return
- ALDS: External accumulator, spring return
- ALD: External accumulator, air or mechanical return

Ordering Example

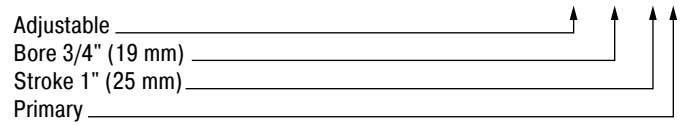

| Dimensions | | | |
|-------------|----------------|----------------|------------|
| TYPES | Stroke inch | A max. inch | L2 inch |
| SALD3/4X1-P | 0.91 | 5.94 | 3.97 |
| SALD3/4X2-P | 1.91 | 7.94 | 4.97 |
| SALD3/4X3-P | 2.91 | 9.94 | 5.97 |

| Performance | | | | | | |
|-------------|--------------------------------|----------------------------|--|-----------------------------|-----------------------------|---------------|
| TYPES | Max. Energy Capacity | | | Effective Weight | | Weight lbs |
| | E ₃ in-lbs/cycle | E ₄ in-lbs/h | E ₄ with Air/Oil Tank in-lbs/h | ¹ We min. lbs | ¹ We max. lbs | |
| SALD3/4X1-P | 3,000 | 1,100,000 | 1,600,000 | 20 | 18,000 | 3.24 |
| SALD3/4X2-P | 6,000 | 1,300,000 | 2,000,000 | 35 | 32,000 | 3.99 |
| SALD3/4X3-P | 9,000 | 1,600,000 | 2,400,000 | 50 | 46,000 | 4.94 |

¹ The effective weight range limits can be raised or lowered to special order.

SALD1 1/8-P Primary

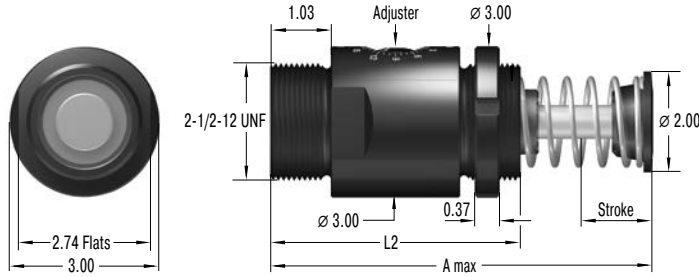

The calculation and selection of the most suitable damper should be carried out or be approved by ACE.

Model Type Prefix

- SALD: Internal accumulator, spring return
- ALDA: Internal accumulator, mechanical return
- ALDS: External accumulator, spring return
- ALD: External accumulator, air or mechanical return

Ordering Example

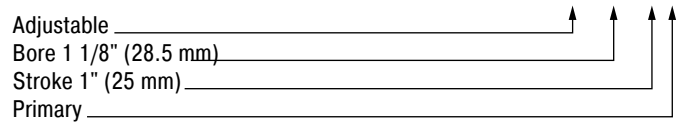

| Dimensions | | | |
|--------------|----------------|----------------|------------|
| TYPES | Stroke inch | A max. inch | L2 inch |
| SALD11/8X2-P | 1.91 | 8.88 | 5.50 |
| SALD11/8X4-P | 3.91 | 12.88 | 7.50 |
| SALD11/8X6-P | 5.91 | 17.75 | 9.50 |

| Performance | | | | | | |
|--------------|--------------------------------|----------------------------|--|-----------------------------|-----------------------------|---------------|
| TYPES | Max. Energy Capacity | | | Effective Weight | | Weight lbs |
| | E ₃ in-lbs/cycle | E ₄ in-lbs/h | E ₄ with Air/Oil Tank in-lbs/h | ¹ We min. lbs | ¹ We max. lbs | |
| SALD11/8X2-P | 16,000 | 1,500,000 | 3,000,000 | 120 | 50,000 | 8.75 |
| SALD11/8X4-P | 32,000 | 2,000,000 | 4,000,000 | 160 | 100,000 | 11.51 |
| SALD11/8X6-P | 48,000 | 2,500,000 | 5,000,000 | 200 | 150,000 | 15.52 |

¹ The effective weight range limits can be raised or lowered to special order.

Issue 04.2018 – Specifications subject to change

SALDN3/4

High energy absorption and a wide effective weight range

Adjustable

Energy capacity 3,450 in-lbs/cycle to 10,350 in-lbs/cycle

Stroke 1 in to 3 in

SALDN industrial shock absorbers offer high performance levels and a long service life, even in the most difficult environments. These shock absorbers feature an integrated positive stop and are designed to handle effective weights from 3,450 to 10,350 in-lbs. per cycle.

High energy absorption in a compact design and a wide damping range lead to huge advantages in practice. Alongside generally more compact designs, these small yet very powerful shock absorbers enable full use of the machine's performance.

These adjustable shock absorbers can be adjusted and precisely adapted to your requirements, making them suitable for a variety of applications in industrial automation and machine engineering applications, especially in automation and gantries.

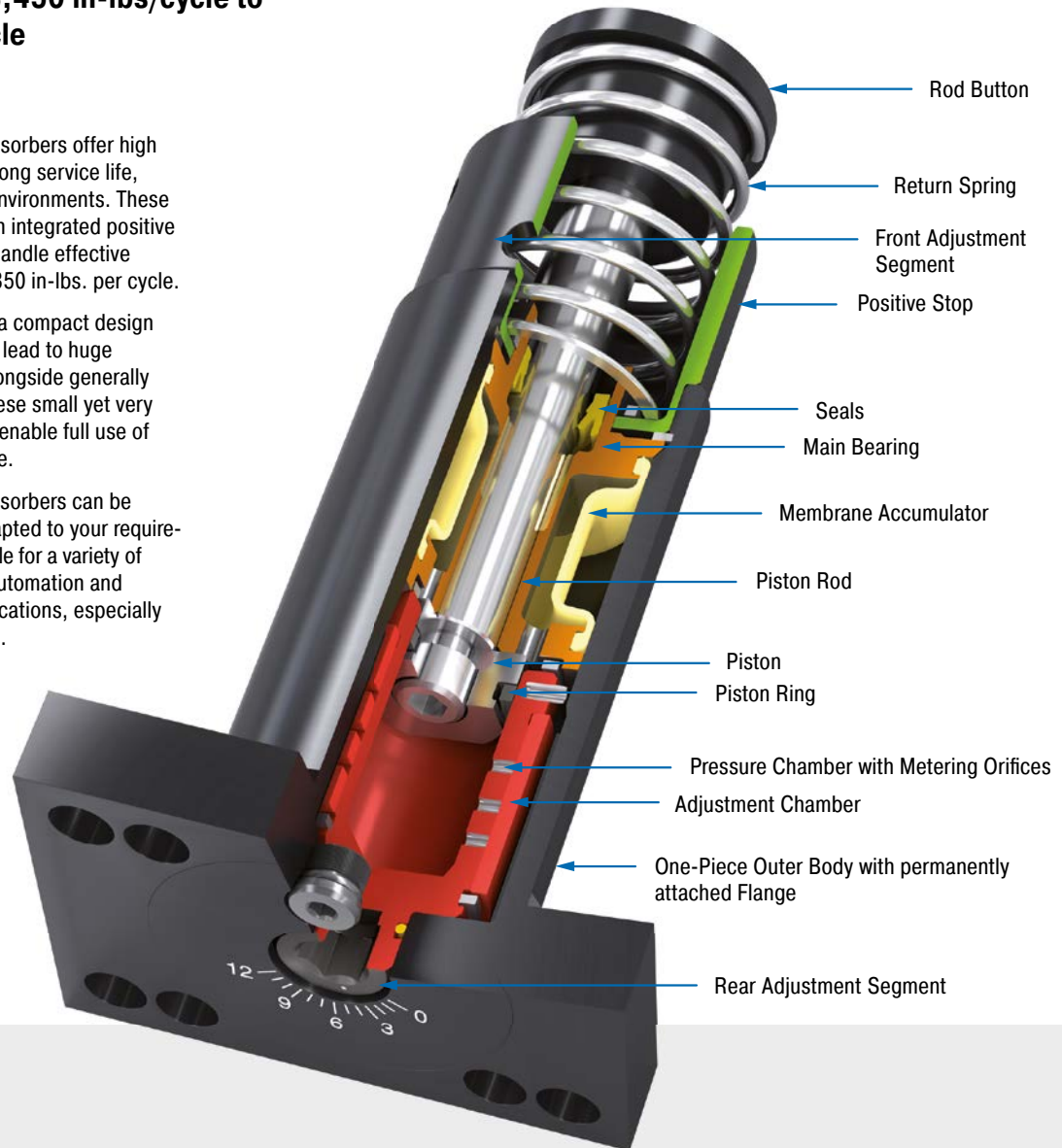

Technical Data

Energy capacity: 3,450 in-lbs/cycle to 10,350 in-lbs/cycle

Impact velocity range: 0.5 ft/sec to 16.5 ft/sec

Operating temperature range: 10 °F to 150 °F

Mounting: In any position

Positive stop: Integrated

Adjustment: Rear of shock

Damping medium: Automatic Transmission Fluid (ATF)

Application field: Linear slides, Pneumatic cylinders, Swivel units, Handling modules,

Machines and plants, Finishing and processing centers, Measuring tables, Tool machines, Machining centers, Locking systems

Note: ACE recommends selecting a model with 20 % more capacity than your calculations indicate necessary. This extra capacity allows for changes in weight, velocity or cycle rates increase in the future.

Safety information: External materials in the surrounding area can attack the seal components and lead to a shorter service life. Please contact ACE for appropriate solution suggestions. Do not paint the shock absorbers due to heat emission.

On request: Special oils, nickel-plated, increased corrosion protection, mounting inside air cylinders, additional impact velocity ranges or other special options are available on request.

SALDN3/4-RF Front Flange

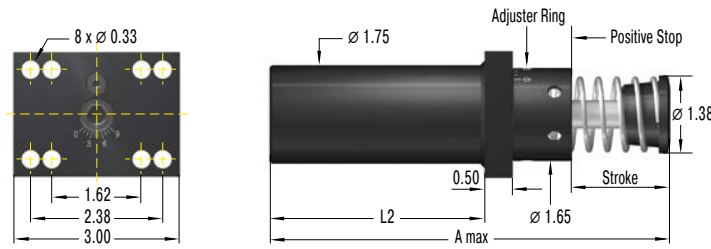

The calculation and selection of the most suitable damper should be carried out or be approved by ACE.

Model Type Prefix

- SALDN: Internal accumulator, spring return
- ALDAN: Internal accumulator, mechanical return
- ALDSN: External accumulator, spring return
- ALDN: External accumulator, air or mechanical return

Ordering Example

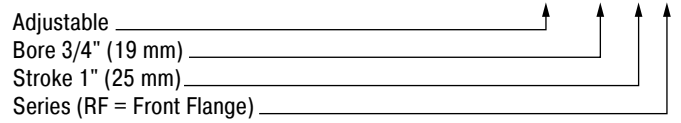

Dimensions

| TYPES | Stroke inch | A max. inch | L2 inch |
|---------------|----------------|----------------|------------|
| SALDN3/4X1-RF | 0.98 | 5.69 | 3.22 |
| SALDN3/4X2-RF | 1.97 | 7.69 | 4.22 |
| SALDN3/4X3-RF | 2.95 | 9.69 | 5.22 |

Performance

| TYPES | Max. Energy Capacity | | | Effective Weight | | Return Force | | Return Time s | Side Load Angle | | Weight lbs |
|---------------|--------------------------------|----------------------------|---|-----------------------------|-----------------------------|--------------|-------------|------------------|-----------------|-----------|---------------|
| | E ₃ in-lbs/cycle | E ₄ in-lbs/h | E ₄ with Air/Oil Tank in-lbs/h | ¹ We min. lbs | ¹ We max. lbs | min. lbs | max. lbs | | min. ° | max. ° | |
| SALDN3/4X1-RF | 3,450 | 950,000 | 1,400,000 | 95 | 22,000 | 15.1 | 22.8 | 0.03 | 4 | 2.49 | |
| SALDN3/4X2-RF | 6,900 | 1,000,000 | 1,700,000 | 150 | 32,000 | 15.1 | 32.2 | 0.08 | 3 | 3.02 | |
| SALDN3/4X3-RF | 10,350 | 1,300,000 | 2,000,000 | 155 | 33,000 | 11.7 | 40.3 | 0.11 | 2 | 3.51 | |

¹ The effective weight range limits can be raised or lowered to special order.

Adjustable

SALDN3/4-RR Rear Flange

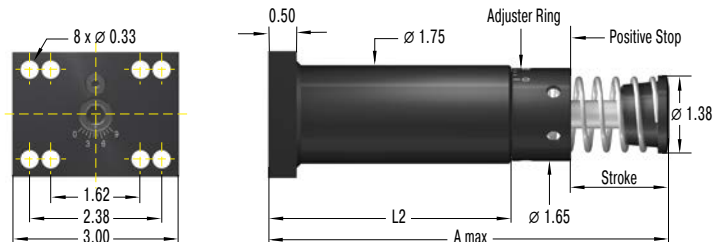

The calculation and selection of the most suitable damper should be carried out or be approved by ACE.

Model Type Prefix

- SALDN: Internal accumulator, spring return
- ALDAN: Internal accumulator, mechanical return
- ALDSN: External accumulator, spring return
- ALDN: External accumulator, air or mechanical return

Ordering Example

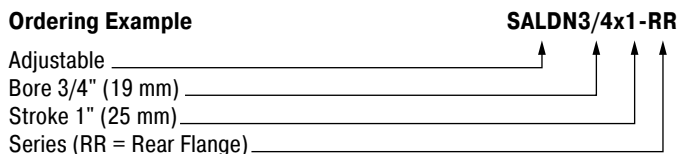

Dimensions

| TYPES | Stroke inch | A max. inch | L2 inch |
|---------------|----------------|----------------|------------|
| SALDN3/4X1-RR | 0.98 | 5.69 | 3.22 |
| SALDN3/4X2-RR | 1.97 | 7.69 | 4.22 |
| SALDN3/4X3-RR | 2.95 | 9.69 | 5.22 |

Performance

| TYPES | Max. Energy Capacity | | | Effective Weight | | Return Force min. lbs | Return Force max. lbs | Return Time s | Side Load Angle max. ° | Weight lbs |
|---------------|--------------------------------|----------------------------|---|-----------------------------|-----------------------------|-----------------------------|-----------------------------|------------------|------------------------------|---------------|
| | E ₃ in-lbs/cycle | E ₄ in-lbs/h | E ₄ with Air/Oil Tank in-lbs/h | ¹ We min. lbs | ¹ We max. lbs | | | | | |
| SALDN3/4X1-RR | 3,450 | 950,000 | 1,400,000 | 95 | 22,000 | 15.1 | 22.8 | 0.03 | 4 | 2.49 |
| SALDN3/4X2-RR | 6,900 | 1,000,000 | 1,700,000 | 150 | 32,000 | 15.1 | 32.2 | 0.08 | 3 | 3.02 |
| SALDN3/4X3-RR | 10,350 | 1,300,000 | 2,000,000 | 155 | 33,000 | 11.7 | 40.3 | 0.11 | 2 | 3.51 |

¹ The effective weight range limits can be raised or lowered to special order.

High Performance

for PET Stretch Blow Machines

NEW



PET 20 and PET 27

**20 million cycles – up to 225 °F – aluminium outer body
hardened pressure chamber – corrosion protection**

=

extended service life – low-wear – faster
reduced downtime – improved system performance
increased production volume – high cost efficiency

For all information see our Website www.acecontrols.com

M33x1.5

250-0294
Side Foot Mounting Kit

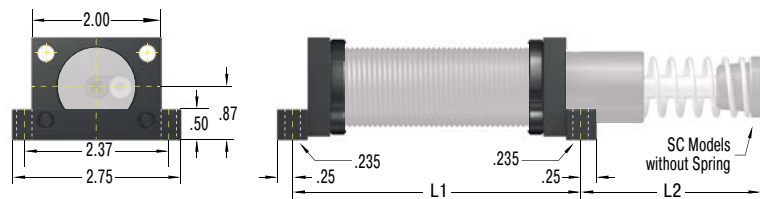

Dimensions

| TYPES | L1 inch | L2 inch |
|----------------|------------|------------|
| MC, MA, ML3325 | 3.75 | 1.94 |
| MC, MA, ML3350 | 4.75 | 2.94 |
| SC3325 | 5.31 | 1.94 |
| SC3350 | 7.31 | 2.94 |
| SCS33-25 | 3.75 | 1.94 |
| SCS33-50 | 4.75 | 2.94 |

250-0294 = 1 locknut, 2 flanges, 2 bars, 4 screws M6x40, DIN 912
 Torque max.: 97 in-lbs
 Clamping torque: 797 in-lbs
 Bolts to mount assembled shock & mount not included.

250-0323
Clevis Mount Assembly

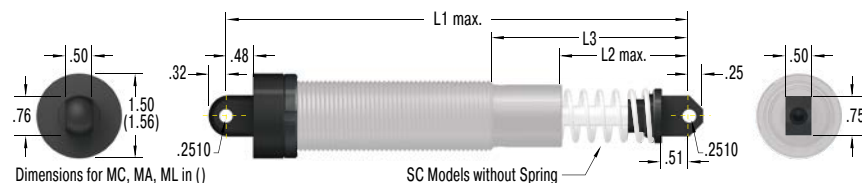

Dimensions

| TYPES | L1 max. inch | L2 max. inch | L3 inch |
|----------------|-----------------|-----------------|------------|
| MC, MA, ML3325 | 6.58 | 1.36 | 2.64 |
| MC, MA, ML3350 | 8.58 | 2.36 | 3.64 |
| SC3325 | 8.14 | 1.37 | 2.65 |
| SC3350 | 11.14 | 2.37 | 3.65 |

Use positive stop at both ends of travel.

250-0292
Locking Ring

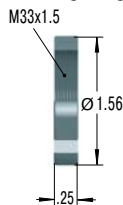

250-0091
Poly Button

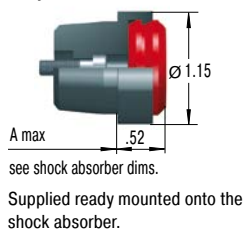

250-0293
Rectangular Flange

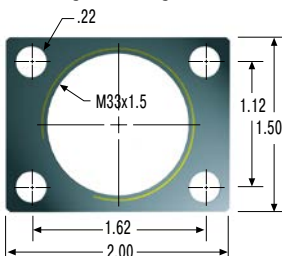

250-0130
Steel Shroud

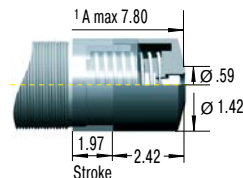

¹ Total installation length of the shock absorber inc. steel shroud

250-0730
Steel Shroud

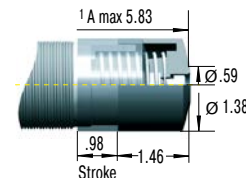

¹ Total installation length of the shock absorber inc. steel shroud

250-0427
Stop Bar

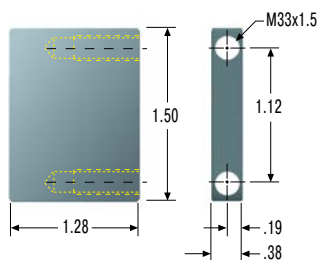

250-0071
Flanged Stop Collar

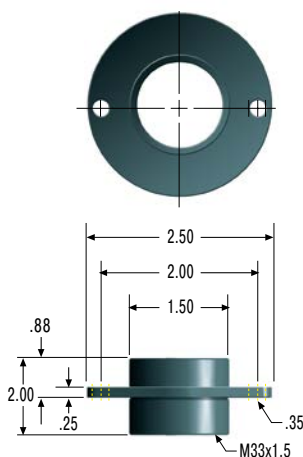

Mounting, installation, ... see page 96.

M45x1.5

250-0300 Side Foot Mounting Kit

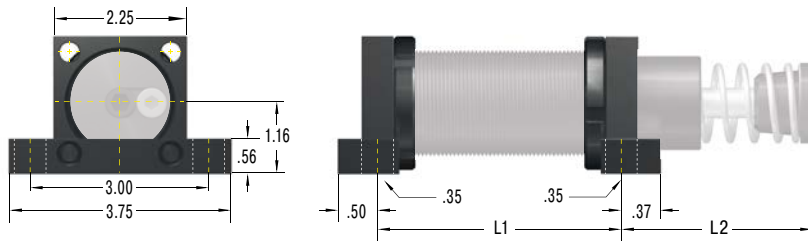

Dimensions

| TYPES | L1 inch | L2 inch |
|----------------|------------|------------|
| MC, MA, ML4525 | 3.50 | 1.94 |
| MC, MA, ML4550 | 4.38 | 3.06 |
| MC, MA4575 | 5.38 | 4.06 |
| SC4525 | 5.10 | 2.09 |
| SC4550 | 7.10 | 3.09 |
| SCS45-25 | 3.50 | 1.94 |
| SCS45-50 | 4.38 | 3.06 |
| SCS45-75 | 5.38 | 4.06 |

250-0300 = 1 locknut, 2 flanges, 2 bars, 4 screws M8x50, DIN 912
 Torque max.: 239 in-lbs
 Clamping torque: 3,098 in-lbs
 Bolts to mount assembled shock & mount not included.

250-0325 Clevis Mount Assembly

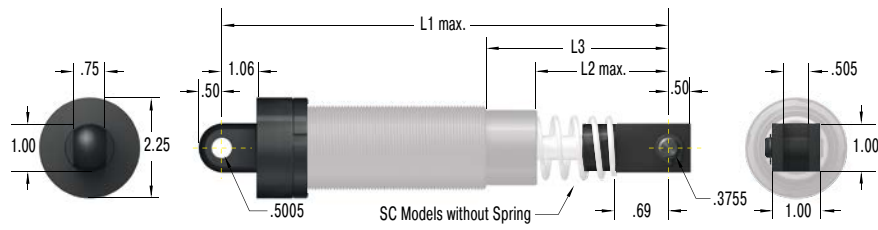

Dimensions

| TYPES | L1 max. inch | L2 max. inch | L3 inch |
|----------------|-----------------|-----------------|------------|
| MC, MA, ML4525 | 7.85 | 1.51 | 2.57 |
| MC, MA, ML4550 | 9.85 | 2.51 | 3.57 |
| MC, MA4575 | 11.85 | 3.51 | 4.57 |
| SC4525 | 9.60 | 1.51 | 2.57 |
| SC4550 | 12.60 | 2.51 | 3.57 |

Use positive stop at both ends of travel.

250-0297 Locking Ring

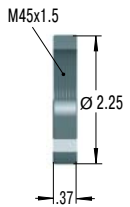

250-0092 Poly Button

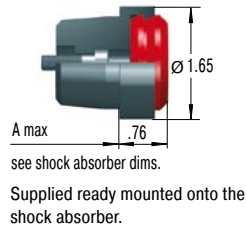

250-0298 Square Flange

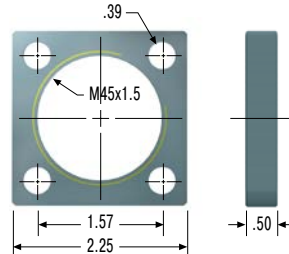

250-0299 Rectangular Flange

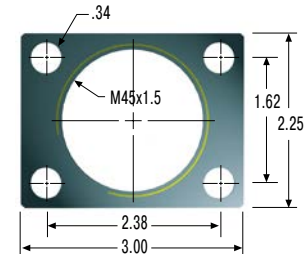

250-0778 Steel Shroud

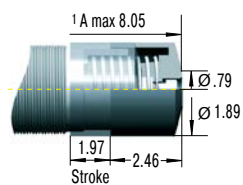

¹ Total installation length of the shock absorber inc. steel shroud

250-0731 Steel Shroud

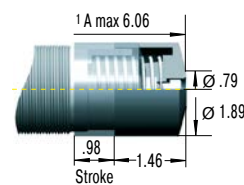

¹ Total installation length of the shock absorber inc. steel shroud

250-0639 Stop Bar

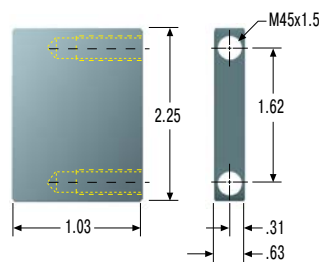

250-0073 Flanged Stop Collar

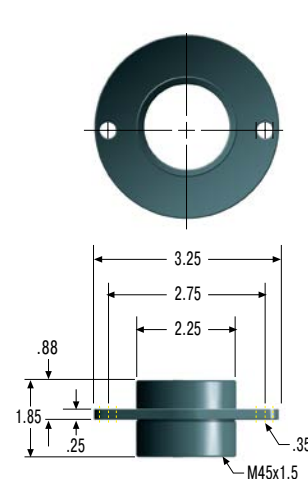

M64x2

250-0304 Side Foot Mounting Kit

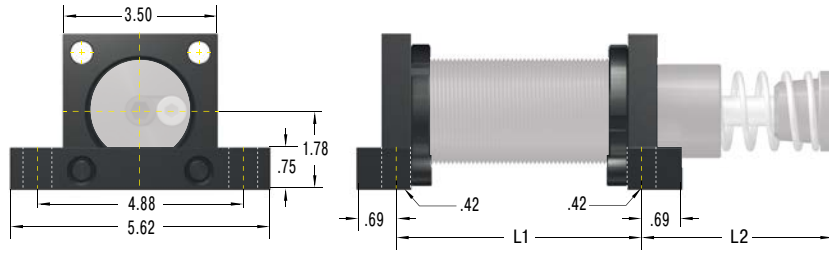

| Dimensions | | |
|----------------|------------|------------|
| TYPES | L1 inch | L2 inch |
| ML6425 | 4.00 | 2.54 |
| MC, MA, ML6450 | 5.00 | 3.54 |
| MC, MA64100 | 7.00 | 5.54 |
| MC, MA64150 | 9.00 | 8.42 |
| SCS64-50 | 5.00 | 3.54 |
| SCS64-100 | 7.00 | 5.54 |
| SCS64-150 | 9.00 | 8.42 |

250-0304 = 1 locknut, 2 flanges, 2 bars, 4 screws M10x80, DIN 912
 Torque max.: 443 in-lbs
 Clamping torque: 3,098 in-lbs
 Bolts to mount assembled shock & mount not included.

250-0626 Clevis Mount Assembly

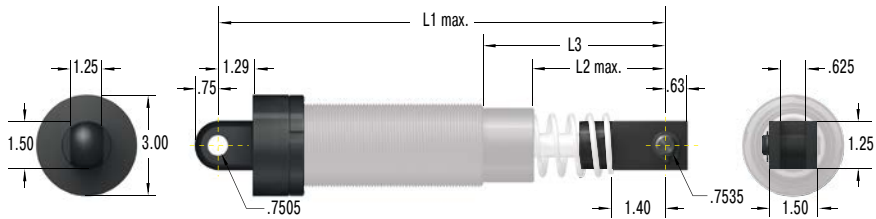

| Dimensions | | | |
|----------------|-----------------|-----------------|------------|
| TYPES | L1 max. inch | L2 max. inch | L3 inch |
| ML6425 | 10.12 | 2.31 | 3.75 |
| MC, MA, ML6450 | 12.12 | 3.31 | 4.75 |
| MC, MA64100 | 16.12 | 5.31 | 6.75 |
| MC, MA64150 | 20.87 | 8.06 | 9.50 |

Use positive stop at both ends of travel.

250-0301 Locking Ring

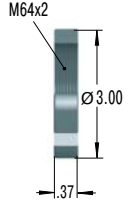

250-0093 Poly Button

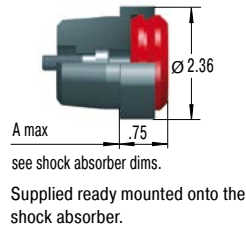

250-0302 Square Flange

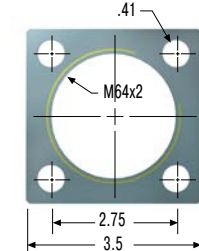

250-0787 Steel Shroud

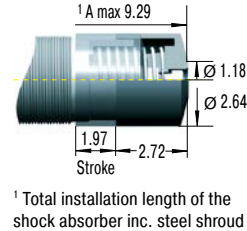

250-0839 Steel Shroud

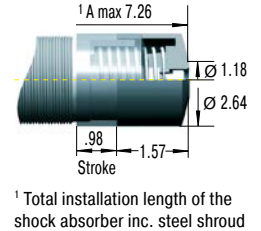

250-0640 Stop Bar

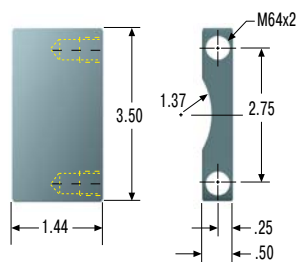

For MC/MA/ML6425M to 64100M models

250-0641 Stop Bar

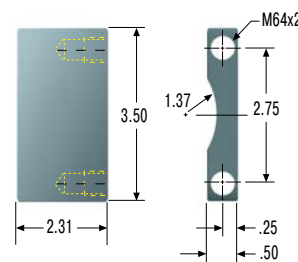

For MC/MA/ML64150M model

250-0077 Flanged Stop Collar

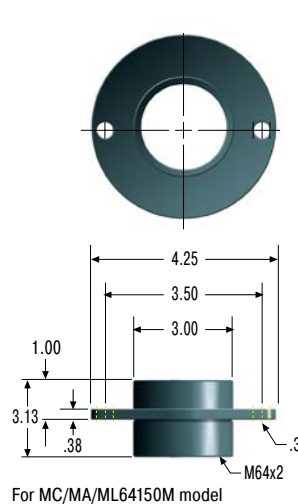

250-0075 Flanged Stop Collar

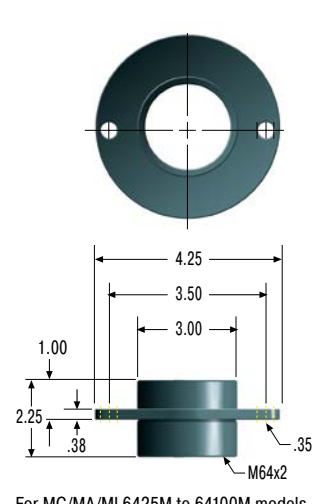

Mounting, installation, ... see page 96.

1-1/4-12 UNF

250-0015 Side Foot Mounting Kit

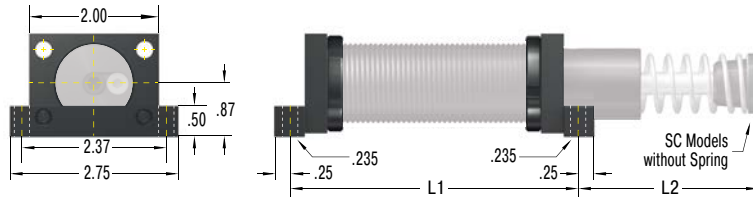

Dimensions

| TYPES | L1 inch | L2 inch |
|----------------|------------|------------|
| MC, MA, ML3325 | 3.75 | 1.94 |
| MC, MA, ML3350 | 4.75 | 2.94 |
| SC3325 | 5.31 | 1.94 |
| SC3350 | 7.31 | 2.94 |
| SCS33-25 | 3.75 | 1.94 |
| SCS33-50 | 4.75 | 2.94 |

250-0015 = 1 locknut, 2 flanges, 2 bars, 4 screws 1-1/4-12 UNF, DIN 912
 Torque max.: 97 in-lbs
 Clamping torque: 797 in-lbs
 Bolts to mount assembled shock & mount not included.

250-0225 Clevis Mount Assembly

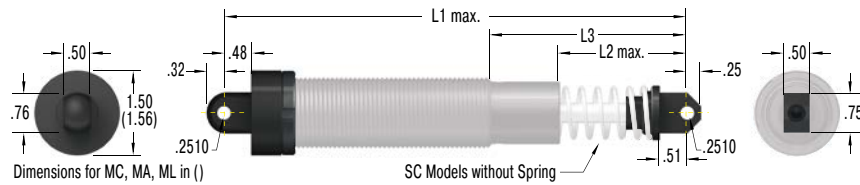

Dimensions

| TYPES | L1 max. inch | L2 max. inch | L3 inch |
|----------------|-----------------|-----------------|------------|
| MC, MA, ML3325 | 6.58 | 1.36 | 2.64 |
| MC, MA, ML3350 | 8.58 | 2.36 | 3.64 |
| SC3325 | 8.14 | 1.37 | 2.65 |
| SC3350 | 11.14 | 2.37 | 3.65 |

Use positive stop at both ends of travel.

250-0038 Locking Ring

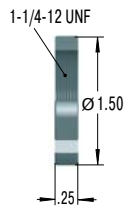

250-0091 Poly Button

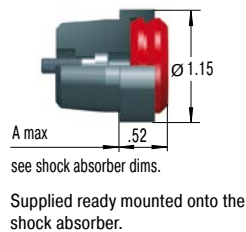

250-0016 Rectangular Flange

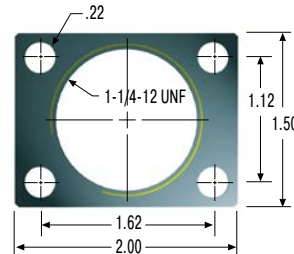

250-0130 Steel Shroud

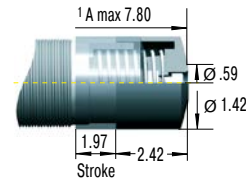

¹ Total installation length of the shock absorber inc. steel shroud

250-0730 Steel Shroud

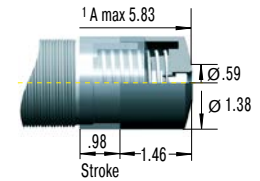

¹ Total installation length of the shock absorber inc. steel shroud

250-0426 Stop Bar

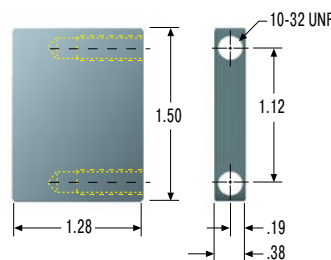

250-0070 Flanged Stop Collar

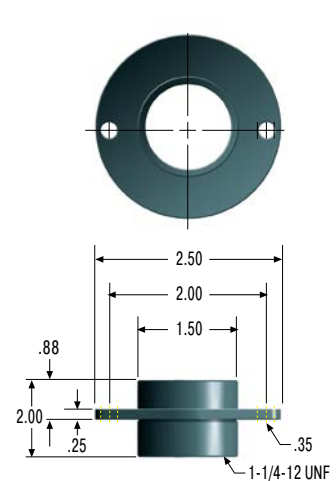

1-3/4-12 UNF

250-0025 Side Foot Mounting Kit

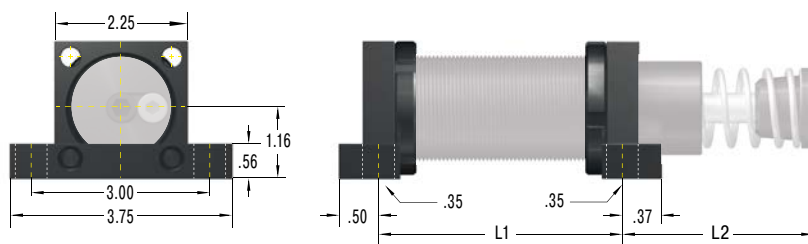

| Dimensions | | |
|----------------|------------|------------|
| TYPES | L1 inch | L2 inch |
| MC, MA, ML4525 | 3.50 | 1.94 |
| MC, MA, ML4550 | 4.38 | 3.06 |
| MC, MA4575 | 5.38 | 4.06 |
| SC4525 | 5.10 | 2.09 |
| SC4550 | 7.10 | 3.09 |
| SCS45-25 | 3.50 | 1.94 |
| SCS45-50 | 4.38 | 3.06 |
| SCS45-75 | 5.38 | 4.06 |

250-0025 = 1 locknut, 2 flanges, 2 bars, 4 screws 1-3/4-12 UNF, DIN 912
 Torque max.: 239 in-lbs
 Clamping torque: 3,098 in-lbs
 Bolts to mount assembled shock & mount not included.

250-0324 Clevis Mount Assembly

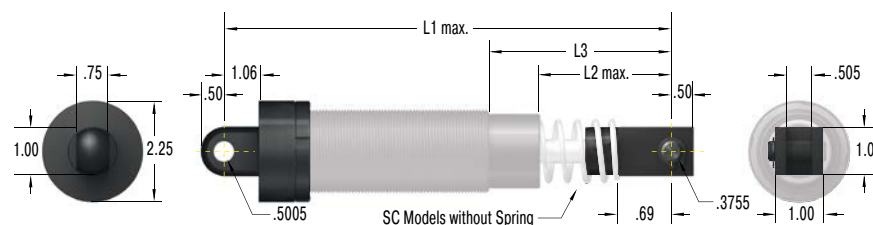

| Dimensions | | | |
|----------------|-----------------|-----------------|------------|
| TYPES | L1 max. inch | L2 max. inch | L3 inch |
| MC, MA, ML4525 | 7.85 | 1.51 | 2.57 |
| MC, MA, ML4550 | 9.85 | 2.51 | 3.57 |
| MC, MA4575 | 11.85 | 3.51 | 4.57 |
| SC4525 | 9.60 | 1.51 | 2.57 |
| SC4550 | 12.60 | 2.51 | 3.57 |

Use positive stop at both ends of travel.

250-0041 Locking Ring

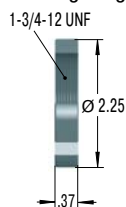

250-0092 Poly Button

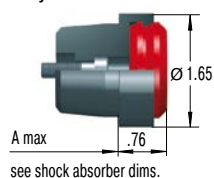

Supplied ready mounted onto the shock absorber.

250-0023 Square Flange

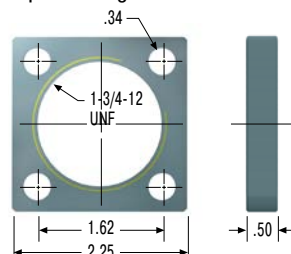

250-0024 Rectangular Flange

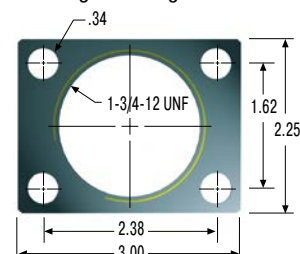

250-0778 Steel Shroud

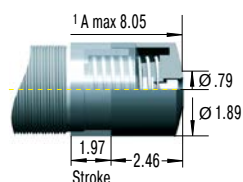

¹ Total installation length of the shock absorber inc. steel shroud

250-0731 Steel Shroud

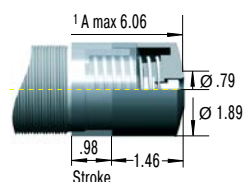

¹ Total installation length of the shock absorber inc. steel shroud

250-0428 Stop Bar

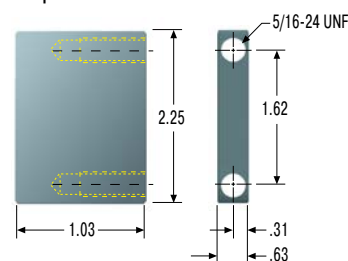

250-0072 Flanged Stop Collar

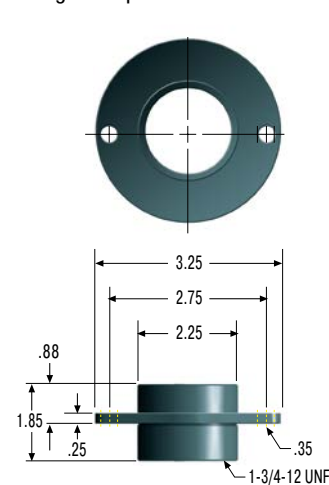

Mounting, installation, ... see page 96.

2-1/2-12 UNF

250-0030

Side Foot Mounting Kit

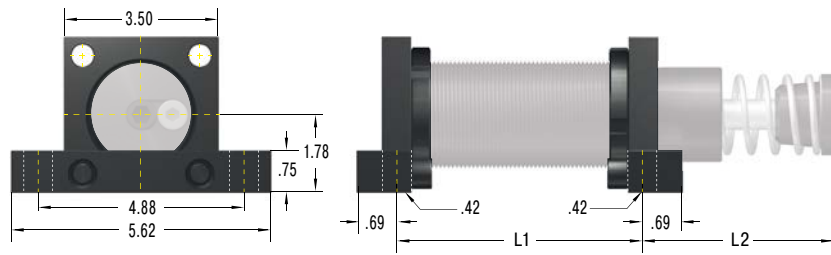

Dimensions

| TYPES | L1 inch | L2 inch |
|----------------|------------|------------|
| ML6425 | 4.00 | 2.54 |
| MC, MA, ML6450 | 5.00 | 3.54 |
| MC, MA64100 | 7.00 | 5.54 |
| MC, MA64150 | 9.00 | 8.42 |
| SCS64-50 | 5.00 | 3.54 |
| SCS64-100 | 7.00 | 5.54 |
| SCS64-150 | 9.00 | 8.42 |

250-0030 = 1 locknut, 2 flanges, 2 bars, 4 screws 2-1/2-12 UNF, DIN 912

Torque max.: 442.5 in-lbs

Clamping torque: 3,098 in-lbs

Bolts to mount assembled shock & mount not included.

250-0625

Clevis Mount Assembly

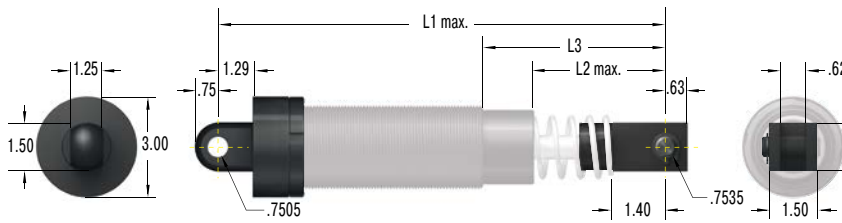

Dimensions

| TYPES | L1 max. inch | L2 max. inch | L3 inch |
|----------------|-----------------|-----------------|------------|
| ML6425 | 10.12 | 2.31 | 3.75 |
| MC, MA, ML6450 | 12.12 | 3.31 | 4.75 |
| MC, MA64100 | 16.12 | 5.31 | 6.75 |
| MC, MA64150 | 20.87 | 8.06 | 9.50 |

Use positive stop at both ends of travel.

250-0042

Locking Ring

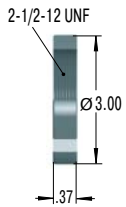

250-0093

Poly Button

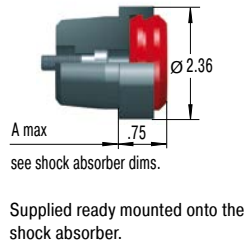

250-0028

Square Flange

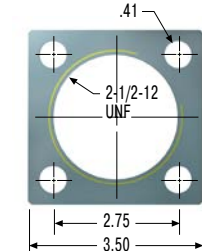

250-0787

Steel Shroud

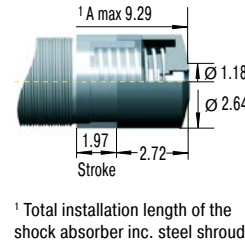

250-0839

Steel Shroud

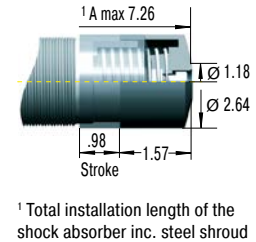

250-0430

Stop Bar

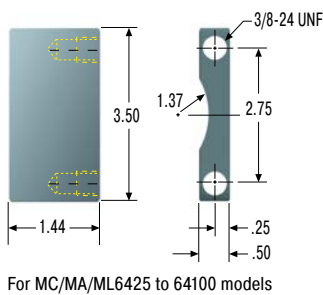

250-0432

Stop Bar

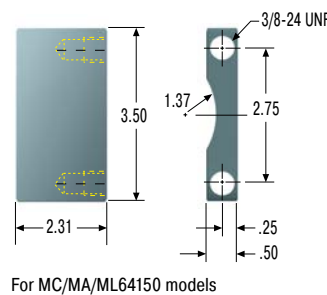

250-0074

Flanged Stop Collar

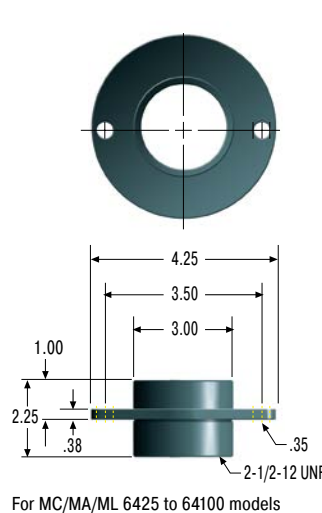

250-0076

Flanged Stop Collar

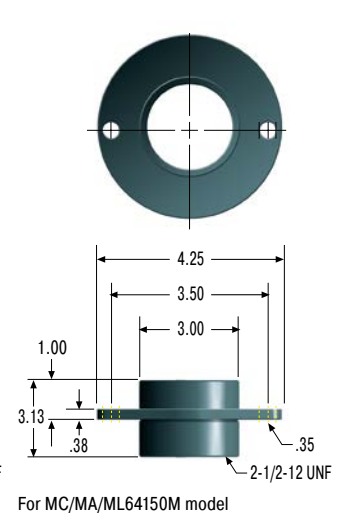

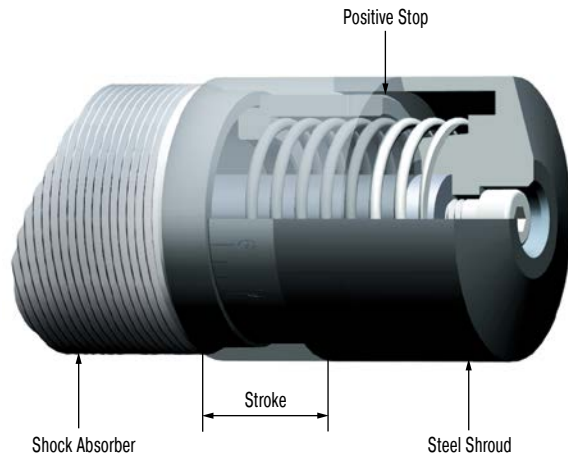

Steel Shroud

For industrial shock absorbers with a 1 or 2 in stroke.

Grinding beads, sand, welding splatter, paints and adhesives etc. can adhere to the piston rod. They then damage the rod seals and the shock absorber quickly fails. In many cases the installation of the optional steel shroud can provide worthwhile protection and increase lifetime.

Material

Hardened high tensile steel

Mounting information

To mount the steel shroud it's necessary to remove the rod end button of the shock absorber.

Safety information

When installing don't forget to allow operating space for the shroud to move as the shock absorber is cycled.

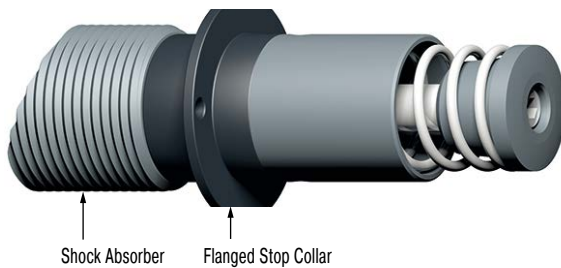

Flanged Stop Collar

Flanged stop collars provide industrial shock absorbers with a secure front mount and a positive mechanical stop. No specific mounting panel thickness is required.

Material

Hardened high tensile steel

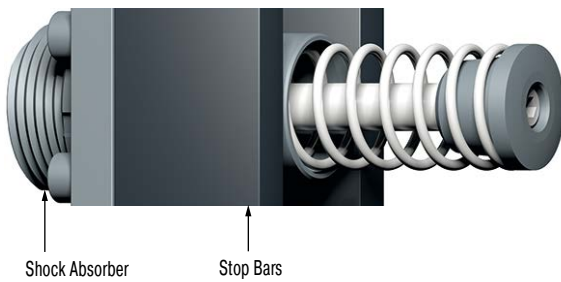

Stop Bar

Stop bars are used in pairs and come two per package for assembly. Hard metric stop bars are available upon request.

Material

Hardened high tensile steel

Application Examples

MC33

Quicker, gentle positioning

ACE industrial shock absorbers optimize portals for machine loading and increase productivity. This device is driven by piston rodless pneumatic cylinders, where two gripper slides are moving independently of each other at speeds of 6.56 ft/sec to 8.20 ft/sec, is equipped with industrial shock absorbers as brake systems. Their function is to stop a mass of 55 lbs up to 540 times per hour. The MC3350-1-S model was chosen for this application, allowing easy and extremely accurate adjustment of the end positions of the adjustable limit stops. In comparison to brake systems with other function principles, shock absorbers allow higher travel speeds and shorter cycle sequences.

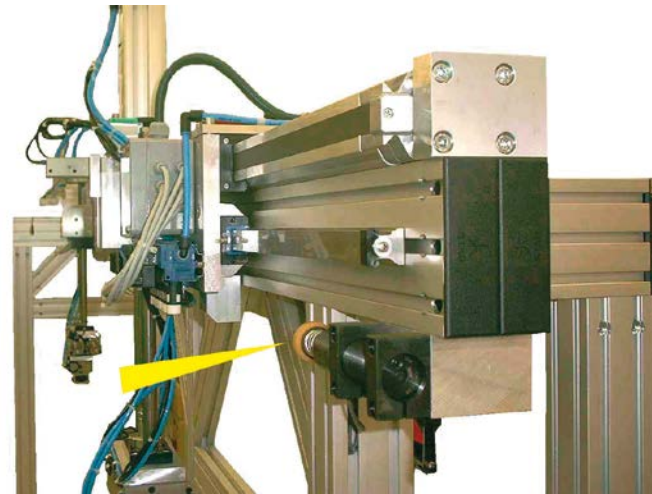

Industrial shock absorbers optimize portal operation

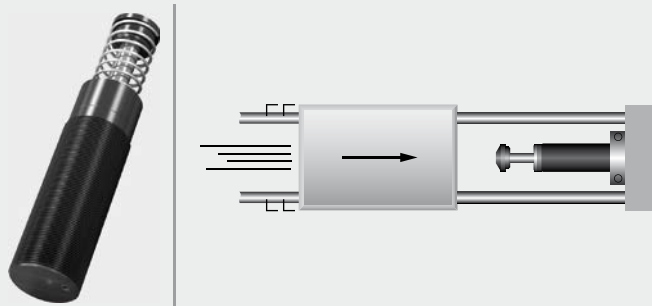

MC45

MAGNUM protection of carriage construction

Serving a similar purpose, several ACE dampers are installed in Jada, the triple-axis, free-moving badminton robot. In order for the badminton robot to be capable of playing, it must be able to change direction in the shortest time possible. Jada is designed therefore to brake at a maximum of 30 m/s². For this task, linear modules are limited by the use of industrial shock absorbers of the type MC4575-0. Miniature shock absorbers and profile dampers are also installed at the location of the „racket hand“. In all cases, the modern ACE machine elements serve to protect the end positions of the construction.

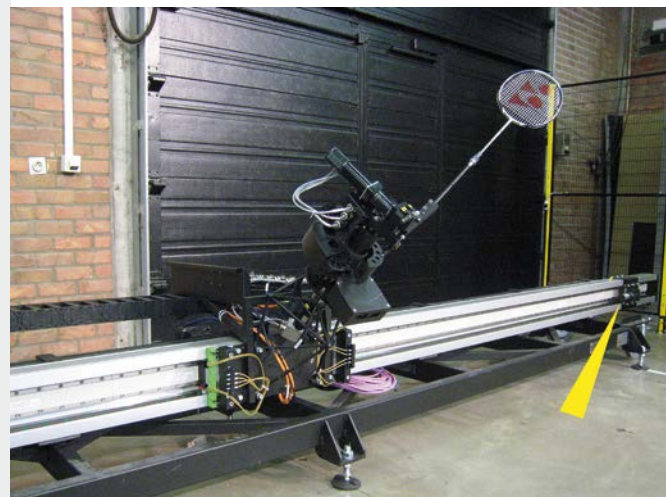

A variety of different dampers are used to slow the rapid movements of a badminton robot
 FMTC vzw, 3001 Leuven, Belgium

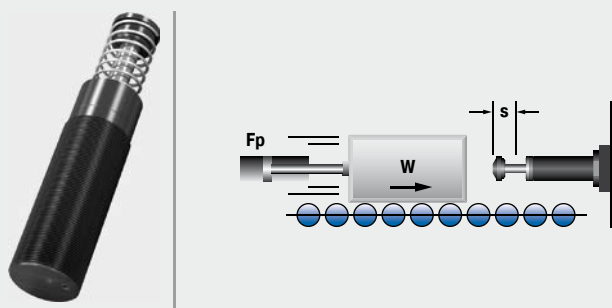

Issue 04.2018 – Specifications subject to change

MC64-VA

MAGNUM damper for safety under water

A pipeline from the rig to the well head that is as flexible as possible is considered to be a quick-disconnect connection in an emergency. Nevertheless, this connection made at the oil source on the sea floor is an Achilles heel. If the connection snaps or if it cannot be separated quickly enough during hazards such as storms, unpredictable, often serious consequences can hardly be prevented. With the so-called XR connector, the safety at this critical point is significantly increased. In the innovative design 10 industrial shock absorbers per connection from the MAGNUM series from ACE master this important task.

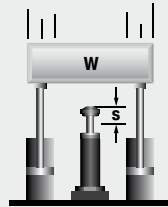

MAGNUMS allow for emergency quick disconnection of the pipelines from the oil rigs

Subsea Technologies Ltd, Aberdeen, AB12 3AY, UK

MC64M

Emergency exits made safer with MAGNUM shock absorbers

MAGNUM 64150 industrial shock absorbers are integrated into the overall safety design for the Amsterdam metro system. In contrast to previous solutions, ACE shocks ensure rapid opening and stopping for a five-ton barrier located at the end of an emergency escape route. In this application, over 45,000 in-lbs of energy are able to be absorbed per stroke. Through installing shock absorbers in end positions of the design, over 140,000 lbs of effective weight are able to be absorbed. ACE provided an excellent solution, even with an impact speed of approximately 6 feet per second and the barrier exit grille at an unusual impact angle.

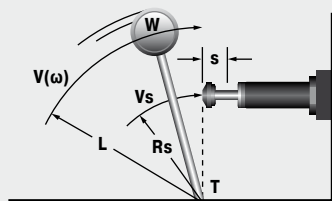

A heavy, five-ton barrier safely stopped by MAGNUM shock absorbers

J.P. van Eesteren B.V., 1006 BD Amsterdam, Netherlands

MA/ML33

Safe swiveling

ACE industrial shock absorbers offer safety to spare for rotation or braking of a large telescope. The optical system of this telescope for special observations is moveable in two space coordinates. The structure in which the telescope is mounted weighs 33,069 lbs and consists of a turntable with drives and two wheel disks rotating on bearings. It enables a rotation by $\pm 90^\circ$ from horizon to horizon. To safeguard the telescope in case of overshooting the respective swiveling limits, ML3325 industrial shock absorbers are used as braking elements. Should the telescope inadvertently overshoot the permissible swivel range, they will safely damp the travel of the valuable telescope.

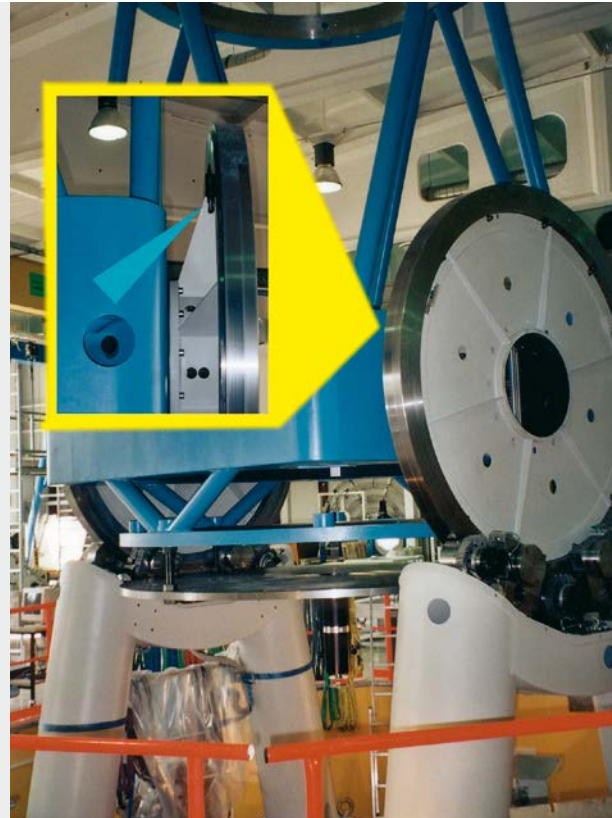
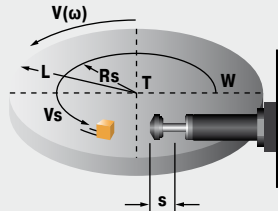

Perfect overshoot protection for precision telescope

MA/ML64

MAGNUM helps in the fight against people not buckling up

The Central-Hessian police department has developed an accident simulator with the help of ACE Stoßdämpfer GmbH aimed at significantly increasing the number of road traffic seatbelt wearers. The mobile simulator demonstrates strikingly that the smallest impact velocities lead to enormous forces, even when wearing seat belts, and can cause serious injuries when not. Adjustable MAGNUM type MA64150 dampers are installed to protect the simulator passengers and the end points of the construction at various speeds and moving masses. These are the largest adjustable dampers of the ACE product range; stronger special constructions are possible at any time.

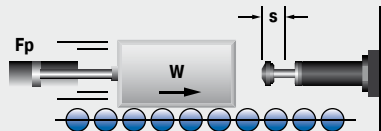

MAGNUM dampers ensure the reliable braking of moving masses on the seat and the protection of the entire carriage construction
Central Hessian Police Department, Karl-Glöckner-Straße 2, 35394 Gießen, Germany

Heavy Industrial Shock Absorbers

Effective shock absorption for heavy loads

The heavy industrial shock absorbers from ACE top off the company's offerings in damping technology. This ACE category gives Designers a choice between self-compensating and adjustable machine elements.

Whichever design is chosen, this type of shock absorber impresses with its robustness and operational readiness wherever heavy loads need to be reliably stopped on-the-spot and at a precise point.

The CA4 models can absorb up to 1,120,000 in/lbf (126,500 Nm) of energy. The series of heavy duty, self-compensating "CA" types are equally suitable for use as an emergency stop as are the adjustable types with the designations "A". The range of effective loads covered is increased considerably for this purpose.



Heavy Industrial Shock Absorbers



CA2 to CA4

Page 102

Self-Compensating

Deceleration of heavy loads

Portal systems, Machines and plants, Conveyor systems, Crane systems,



A1 1/2 to A3

Page 106

Adjustable

Deceleration of heavy loads and progressive adjustment

Portal systems, Machines and plants, Conveyor systems, Crane systems

Rugged and powerful

Gently stops heavy loads with high precision

Also ideal for emergency stop utilization

Safe, reliable production

Maintenance-free and ready-to-install

Special versions available



CA2 to CA4

Deceleration of heavy loads

Self-Compensating

Energy capacity 21,000 in-lbs/Cycle to 1,120,000 in-lbs/Cycle

Stroke 2 in to 16 in

Powerful: The weight of these high capacity absorbers are between 28.2 lbs and 322 lbs. (12.8 and 146 kg). They complement ACE's product range of self-compensating shock absorbers. All models from this product family are designed for applications where robustness and large energy absorption are important.

ACE uses our proprietary custom calculation program to design each shock absorber for the specific customer application. Customization helps reduce the risk of crashes and incorrect product sizing. The CA models can absorb up to 1,119,620 in-lbs (126,500 Nm) of energy and can be used in the area of effective weights between 1,543 lbs and 718,707 lbs. (700 kg and 326,000 kg). The combination of being extremely solid, absorbing high levels of energy and having a large damping range makes them invaluable. Self-compensating shock absorbers react to changing energy conditions, without adjustment.

These heavy duty self-compensating industrial shock absorbers are primarily used in heavy industrial engineering e.g. on lift bridges and steel structures or for damping sluice systems.

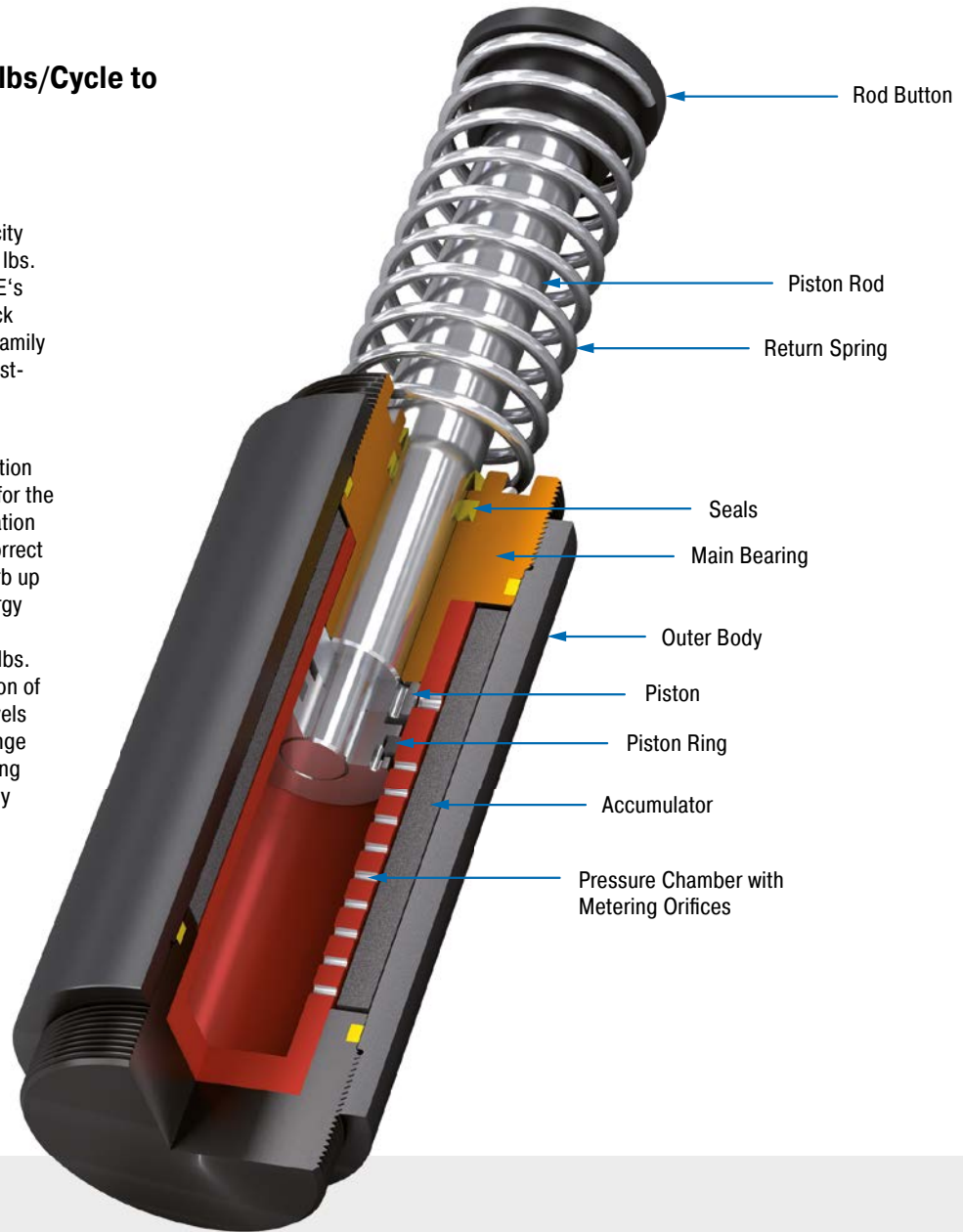

Technical Data

Energy capacity: 21,000 in-lbs/Cycle to 1,120,000 in-lbs/Cycle

Impact velocity range: 1 ft/sec to 16.5 ft/sec. Other speeds on request.

Operating temperature range: 10 °F to 150 °F. Other temperatures on request.

Mounting: In any position

Positive stop: External positive stops 0.10" to 0.12" before the end of stroke provided by the customer.

Material: Outer body: Steel corrosion-resistant coating; Piston rod: Hard chrome plated steel; Rod end button: Hardened steel and corrosion-resistant coating; Return spring: Zinc plated steel

Damping medium: Automatic Transmission Fluid (ATF)

Application field: Portal systems, Machines and plants, Conveyor systems, Crane systems, Loading and lifting equipment, Shelf storage systems, Heavy load applications, Swivel units

Note: For emergency use only applications and for continuous use it is possible to exceed the published max. capacity ratings. In this case, please consult ACE.

Safety information: External materials in the surrounding area can attack the seal components and lead to a shorter service life. Please contact ACE for appropriate solution sugges-

tions. Do not paint the shock absorbers due to heat emission.

On request: Special oils, nickel-plated, increased corrosion protection or other special options are available on request.

CA2-F Front Flange

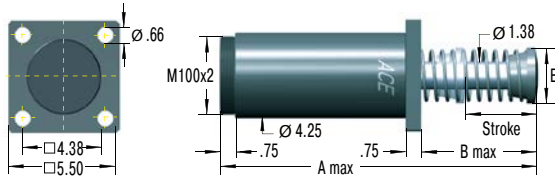

CA2-R Rear Flange

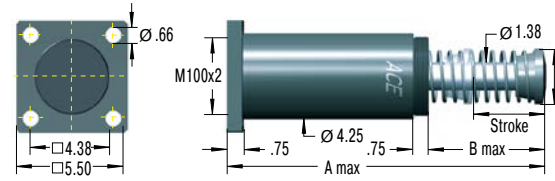

CA2-C Clevis Mount

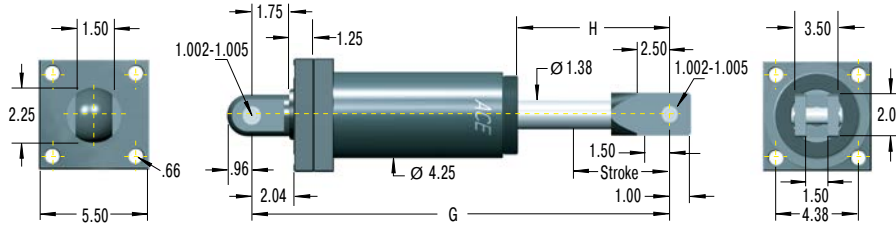

Model Type Prefix

Standard Models

CA: Self-contained with return spring, self-compensating

Special Models

CAA: Air/Oil return without return spring. Use only with external air/oil tank.

CNA: Self-Contained without return spring

CSA: Air/Oil return with return spring. Use only with external air/oil tank.

CA2-S 2" Bore Foot Mount

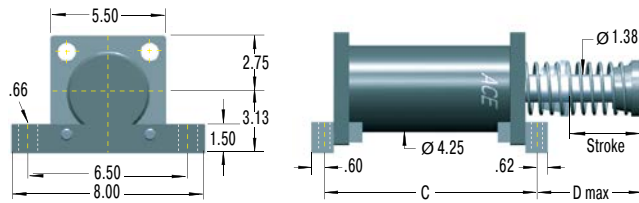

Ordering Example

Self-Compensating CA2x4F-3
 Bore Size \varnothing 2"
 Stroke Length 4" (102 mm)
 Front Flange Mounting
 Effective Weight Range Version

The calculation and selection of the most suitable damper should be carried out or be approved by ACE.

Dimensions

| TYPES | Stroke inch | A max. inch | B max. inch | C inch | D max. inch | E inch |
|--------|----------------|----------------|----------------|-----------|----------------|-----------|
| CA2X2 | 2.00 | 12.37 | 4.37 | 9.28 | 3.74 | 2.73 |
| CA2X4 | 4.00 | 16.37 | 6.31 | 11.28 | 5.74 | 2.73 |
| CA2X6 | 6.00 | 20.37 | 8.37 | 13.28 | 7.74 | 2.73 |
| CA2X8 | 8.00 | 25.37 | 11.37 | 15.28 | 10.74 | 3.63 |
| CA2X10 | 10.00 | 29.37 | 13.37 | 17.28 | 12.74 | 4.25 |

Performance

| TYPES | Max. Energy Capacity | | | Effective Weight | | | Return Force min. lbs | Return Force max. lbs | Return Time s | Side Load Angle max. ° | Weight lbs |
|----------|---|---|---|-----------------------------|-----------------------------|----------|-----------------------------|-----------------------------|------------------|------------------------------|---------------|
| | ¹ E ₃ in-lbs/cycle | ² E ₄ in-lbs/h | ² E ₄ with Air/Oil Tank in-lbs/h | ³ We min. lbs | ³ We max. lbs | Hardness | | | | | |
| CA2X2-1 | 32,000 | 9,600,000 | 12,000,000 | 1,600 | 4,800 | -1 | 48 | 63 | 0.25 | 3 | 28.2 |
| CA2X2-2 | 32,000 | 9,600,000 | 12,000,000 | 4,000 | 12,000 | -2 | 48 | 63 | 0.25 | 3 | 28.2 |
| CA2X2-3 | 32,000 | 9,600,000 | 12,000,000 | 10,000 | 30,000 | -3 | 48 | 63 | 0.25 | 3 | 28.2 |
| CA2X2-4 | 32,000 | 9,600,000 | 12,000,000 | 25,000 | 75,000 | -4 | 48 | 63 | 0.25 | 3 | 28.2 |
| CA2X4-1 | 64,000 | 12,000,000 | 15,000,000 | 3,200 | 9,600 | -1 | 34 | 63 | 0.50 | 3 | 32.6 |
| CA2X4-2 | 64,000 | 12,000,000 | 15,000,000 | 8,000 | 24,000 | -2 | 34 | 63 | 0.50 | 3 | 32.6 |
| CA2X4-3 | 64,000 | 12,000,000 | 15,000,000 | 20,000 | 80,000 | -3 | 34 | 63 | 0.50 | 3 | 32.6 |
| CA2X4-4 | 64,000 | 12,000,000 | 15,000,000 | 50,000 | 150,000 | -4 | 34 | 63 | 0.50 | 3 | 32.6 |
| CA2X6-1 | 96,000 | 14,400,000 | 18,000,000 | 4,800 | 14,400 | -1 | 34 | 90 | 0.60 | 3 | 37.3 |
| CA2X6-2 | 96,000 | 14,400,000 | 18,000,000 | 12,000 | 36,000 | -2 | 34 | 90 | 0.60 | 3 | 37.3 |
| CA2X6-3 | 96,000 | 14,400,000 | 18,000,000 | 30,000 | 90,000 | -3 | 34 | 90 | 0.60 | 3 | 37.3 |
| CA2X6-4 | 96,000 | 14,400,000 | 18,000,000 | 75,000 | 225,000 | -4 | 34 | 90 | 0.60 | 3 | 37.3 |
| CA2X8-1 | 128,000 | 16,800,000 | 21,000,000 | 6,400 | 19,200 | -1 | 51 | 144 | 0.70 | 3 | 42.6 |
| CA2X8-2 | 128,000 | 16,800,000 | 21,000,000 | 16,000 | 48,000 | -2 | 51 | 144 | 0.70 | 3 | 42.6 |
| CA2X8-3 | 128,000 | 16,800,000 | 21,000,000 | 40,000 | 120,000 | -3 | 51 | 144 | 0.70 | 3 | 42.6 |
| CA2X8-4 | 128,000 | 16,800,000 | 21,000,000 | 100,000 | 300,000 | -4 | 51 | 144 | 0.70 | 3 | 42.6 |
| CA2X10-1 | 160,000 | 19,200,000 | 24,000,000 | 8,000 | 24,000 | -1 | 35 | 101 | 0.80 | 3 | 50.3 |
| CA2X10-2 | 160,000 | 19,200,000 | 24,000,000 | 20,000 | 60,000 | -2 | 35 | 101 | 0.80 | 3 | 50.3 |
| CA2X10-3 | 160,000 | 19,200,000 | 24,000,000 | 50,000 | 150,000 | -3 | 35 | 101 | 0.80 | 3 | 50.3 |
| CA2X10-4 | 160,000 | 19,200,000 | 24,000,000 | 125,000 | 375,000 | -4 | 35 | 101 | 0.80 | 3 | 50.3 |

¹ For emergency use only applications it is sometimes possible to exceed the above ratings. Please consult ACE for further details.

² Figures for oil recirculation systems on request.

³ The effective weight range limits can be raised or lowered to special order.

Self-Compensating

CA3-F Front Flange

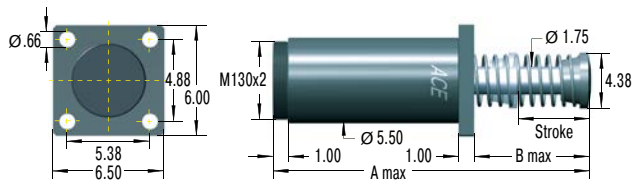

CA3-R Rear Flange

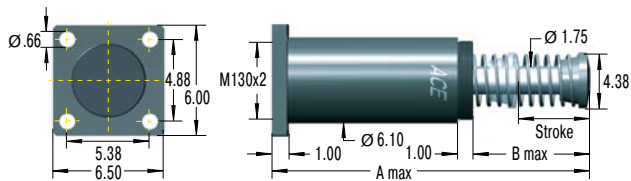

CA3-C Clevis Mount

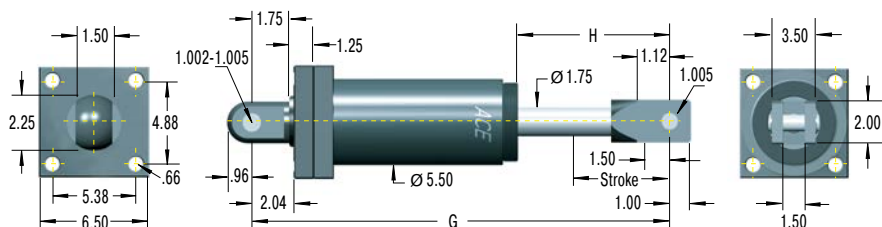

CA3-S Foot Mount

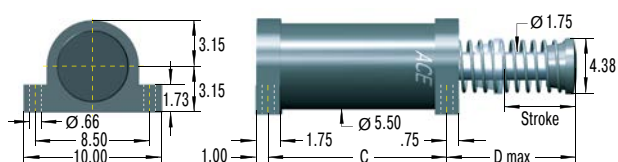

The calculation and selection of the most suitable damper should be carried out or be approved by ACE.

Model Type Prefix

Standard Models

CA: Self-contained with return spring, self-compensating

Special Models

CAA: Air/Oil return without return spring. Use only with external air/oil tank.

CNA: Self-Contained without return spring

CSA: Air/Oil return with return spring. Use only with external air/oil tank.

Ordering Example

Self-Compensating CA3x5-3F
 Bore Size Ø 3"
 Stroke Length 5" = 127 mm
 Effective Weight Range Version
 Front Flange Mounting

Dimensions

| TYPES | Stroke inch | A max. inch | B max. inch | C inch | D max. inch |
|--------|----------------|----------------|----------------|-----------|----------------|
| CA3X5 | 5.00 | 19.31 | 8.31 | 9.95 | 8.81 |
| CA3X8 | 8.00 | 25.31 | 11.31 | 12.95 | 11.81 |
| CA3X12 | 12.00 | 35.09 | 17.09 | 16.95 | 17.59 |

Performance

| TYPES | Max. Energy Capacity | | | Effective Weight | | | Return Force min. lbs | Return Force max. lbs | Return Time s | Side Load Angle max. ° | Weight lbs |
|----------|---|---|---|-----------------------------|-----------------------------|----------|-----------------------------|-----------------------------|------------------|------------------------------|---------------|
| | ¹ E ₃ in-lbs/cycle | ² E ₄ in-lbs/h | ² E ₄ with Air/Oil Tank in-lbs/h | ³ We min. lbs | ³ We max. lbs | Hardness | | | | | |
| CA3X5-1 | 125,000 | 20,000,000 | 25,000,000 | 6,400 | 19,200 | -1 | 59 | 156 | 0.6 | 3 | 63.7 |
| CA3X5-2 | 125,000 | 20,000,000 | 25,000,000 | 16,000 | 48,000 | -2 | 59 | 156 | 0.6 | 3 | 63.7 |
| CA3X5-3 | 125,000 | 20,000,000 | 25,000,000 | 40,000 | 120,000 | -3 | 59 | 156 | 0.6 | 3 | 63.7 |
| CA3X5-4 | 125,000 | 20,000,000 | 25,000,000 | 100,000 | 300,000 | -4 | 59 | 156 | 0.6 | 3 | 63.7 |
| CA3X8-1 | 200,000 | 32,000,000 | 40,000,000 | 10,240 | 30,720 | -1 | 62 | 162 | 0.8 | 3 | 73.6 |
| CA3X8-2 | 200,000 | 32,000,000 | 40,000,000 | 25,600 | 76,800 | -2 | 62 | 162 | 0.8 | 3 | 73.6 |
| CA3X8-3 | 200,000 | 32,000,000 | 40,000,000 | 64,000 | 192,000 | -3 | 62 | 162 | 0.8 | 3 | 73.6 |
| CA3X8-4 | 200,000 | 32,000,000 | 40,000,000 | 160,000 | 480,000 | -4 | 62 | 162 | 0.8 | 3 | 73.6 |
| CA3X12-1 | 300,000 | 48,000,000 | 60,000,000 | 15,360 | 46,080 | -1 | 60 | 160 | 1.2 | 3 | 89.5 |
| CA3X12-2 | 300,000 | 48,000,000 | 60,000,000 | 38,400 | 15,200 | -2 | 60 | 160 | 1.2 | 3 | 89.5 |
| CA3X12-3 | 300,000 | 48,000,000 | 60,000,000 | 96,000 | 288,000 | -3 | 60 | 160 | 1.2 | 3 | 89.5 |
| CA3X12-4 | 300,000 | 48,000,000 | 60,000,000 | 240,000 | 720,000 | -4 | 60 | 160 | 1.2 | 3 | 89.5 |

¹ For emergency use only applications it is sometimes possible to exceed the above ratings. Please consult ACE for further details.

² Figures for oil recirculation systems on request.

³ The effective weight range limits can be raised or lowered to special order.

CA4-F Front Flange

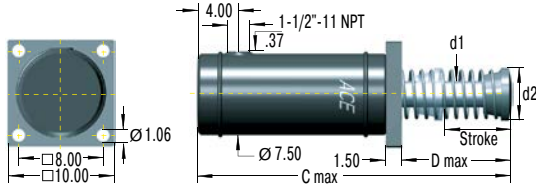

CA4-R Rear Flange

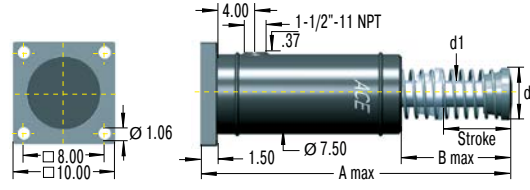

CA4-FRP 6 Tapped Holes Primary Mounting

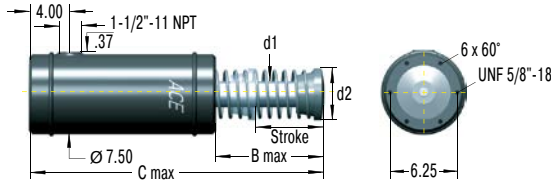

CA4-C Clevis Mount

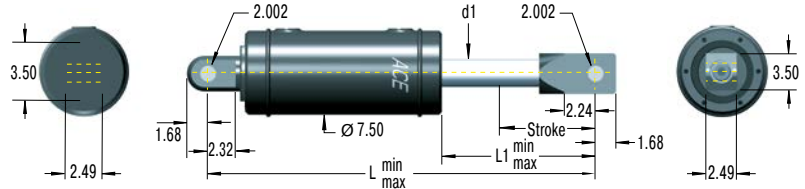

CA4-S Foot Mount

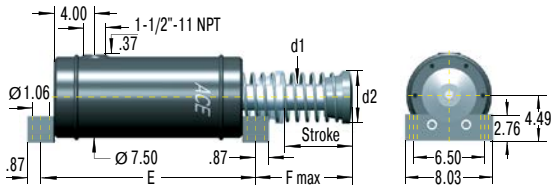

The calculation and selection of the most suitable damper should be carried out or be approved by ACE.

Model Type Prefix

Standard Models

CA: Self-contained with return spring, self-compensating

Special Models

CAA: Air/Oil return without return spring. Use only with external air/oil tank.

CNA: Self-Contained without return spring

CSA: Air/Oil return with return spring. Use only with external air/oil tank.

Ordering Example

Self-Compensating CA4x8R-5
 Bore Size \varnothing 4" ↑↑↑
 Stroke Length 8" (203 mm) ↑↑↑
 Rear Flange Mounting ↑↑↑
 Effective Weight Range Version ↑↑↑

Dimensions

| TYPES | Stroke inch | A max. inch | B max. inch | C max. inch | D max. inch | d1 inch | d2 inch | E inch | F inch |
|--------|----------------|----------------|----------------|----------------|----------------|------------|------------|-----------|-----------|
| CA4X6 | 6.00 | 28.21 | 10.96 | 26.71 | 9.46 | 2.12 | 4.50 | 17.50 | 10.09 |
| CA4X8 | 8.00 | 32.21 | 12.96 | 30.71 | 11.46 | 2.12 | 4.50 | 19.50 | 12.09 |
| CA4X16 | 16.00 | 51.21 | 23.96 | 49.71 | 22.46 | 2.50 | 5.00 | 27.50 | 23.09 |

Performance

| TYPES | Max. Energy Capacity | | | | Effective Weight | | | Return Force min. lbs | Return Force max. lbs | Return Time s | Weight lbs |
|----------|---|----------------------------|---|--|-----------------------------|-----------------------------|----------|-----------------------------|-----------------------------|------------------|---------------|
| | ¹ E ₃ in-lbs/cycle | E ₄ in-lbs/h | E ₄ with Air/Oil Tank in-lbs/h | E ₄ with Oil Recirculation in-lbs/h | ² We min. lbs | ² We max. lbs | Hardness | | | | |
| CA4X6-3 | 420,000 | 27,000,000 | 45,000,000 | 58,400,000 | 8,000 | 19,000 | -3 | 108 | 222 | 1.8 | 132.3 |
| CA4X6-5 | 420,000 | 27,000,000 | 45,000,000 | 58,400,000 | 19,000 | 41,000 | -5 | 108 | 222 | 1.8 | 132.3 |
| CA4X6-7 | 420,000 | 27,000,000 | 45,000,000 | 58,400,000 | 41,000 | 94,000 | -7 | 108 | 222 | 1.8 | 132.3 |
| CA4X8-3 | 560,000 | 30,000,000 | 50,000,000 | 64,600,000 | 11,000 | 25,000 | -3 | 71 | 222 | 2.3 | 149.9 |
| CA4X8-5 | 560,000 | 30,000,000 | 50,000,000 | 64,600,000 | 25,000 | 55,000 | -5 | 71 | 222 | 2.3 | 149.9 |
| CA4X8-7 | 560,000 | 30,000,000 | 50,000,000 | 64,600,000 | 55,000 | 125,000 | -7 | 71 | 222 | 2.3 | 149.9 |
| CA4X16-3 | 1,120,000 | 50,000,000 | 85,000,000 | 109,800,000 | 22,000 | 50,000 | -3 | 71 | 222 | ask | 321.9 |
| CA4X16-5 | 1,120,000 | 50,000,000 | 85,000,000 | 109,800,000 | 50,000 | 110,000 | -5 | 71 | 222 | ask | 321.9 |
| CA4X16-7 | 1,120,000 | 50,000,000 | 85,000,000 | 109,800,000 | 110,000 | 250,000 | -7 | 71 | 222 | ask | 321.9 |

¹ For emergency use only applications it is sometimes possible to exceed the above ratings. Please consult ACE for further details.

² The effective weight range limits can be raised or lowered to special order.

A1 1/2 to A3

Deceleration of heavy loads and progressive adjustment

Adjustable

Energy capacity 21,000 in-lbs/Cycle to 390,000 in-lbs/Cycle

Stroke 2.00 in to 12.00 in

Strong and adjustable: Also in ACE's product range of units are adjustable heavy duty industrial shock absorbers. The models from the A1 1/2 to A3 range, which weigh between 16.6 lbs and 105.8 lbs (7.55 and 48 kg), are extremely robust, ready-to-install hydraulic machine components with impressively high energy absorption levels and a wide range of damping rates.

Their special aspect is the flexibility, as all the absorbers can be adjusted using a socket on the absorber base and be perfectly adapted to the application. The A models cover a range of effective weights from 0.66 lbs to 449,743 lbs. (0.3 to 204,000 kg) and can absorb up to 389,433 in-lbs. (44,000 Nm) energy.

These heavy duty, adjustable ACE industrial shock absorbers are the first choice in heavy duty applications and generally in heavy industrial machining design when the usage data has not been exactly determined.

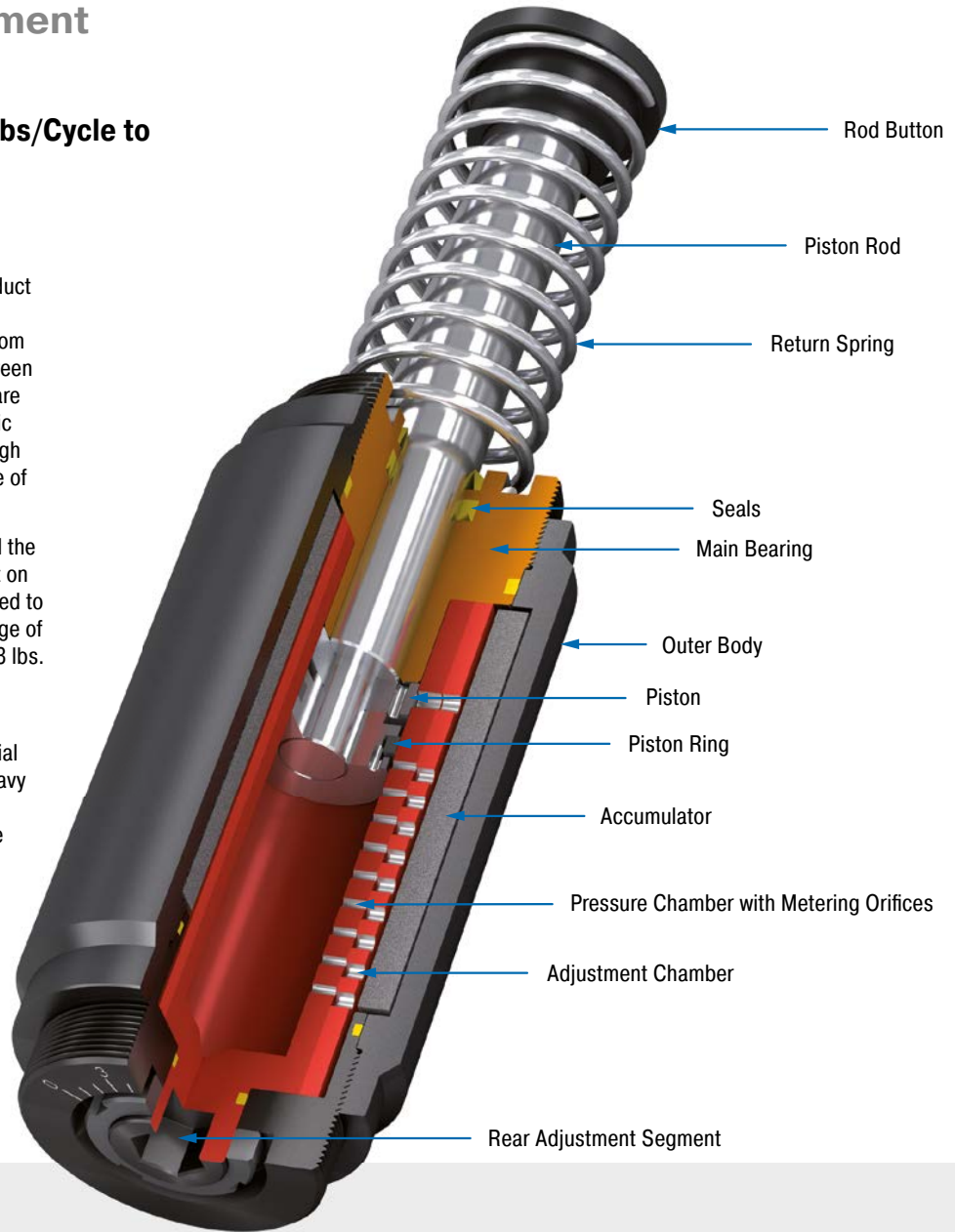

Technical Data

Energy capacity: 21,000 in-lbs/Cycle to 390,000 in-lbs/Cycle

Impact velocity range: 0.5 ft/sec to 15 ft/sec. Other speeds on request.

Operating temperature range: 10 °F to 150 °F. Other temperatures on request.

Mounting: In any position

Positive stop: External positive stops 0.10" to 0.12" before the end of stroke provided by the customer.

Adjustment: Hard impact at the start of stroke, adjust the ring towards 9. Hard impact at the end of stroke, adjust the ring towards 0.

Material: Outer body: Steel corrosion-resistant coating; Piston rod: Hard chrome plated steel; Rod end button: Hardened steel and corrosion-resistant coating; Return spring: Zinc plated steel

Damping medium: Automatic Transmission Fluid (ATF)

Application field: Portal systems, Machines and plants, Conveyor systems, Crane systems, Loading and lifting equipment, Impact panels, Heavy load applications, Swivel units, Shelf storage systems

Note: For emergency use only applications and for continuous use it is possible to exceed

the published max. capacity ratings. In this case, please consult ACE.

Safety information: External materials in the surrounding area can attack the seal components and lead to a shorter service life. Please contact ACE for appropriate solution suggestions. Do not paint the shock absorbers due to heat emission.

On request: Special oils, nickel-plated, increased corrosion protection or other special options are available on request.



A1 1/2-F Front Flange



A1 1/2-R Rear Flange



A1 1/2-C Clevis Mount

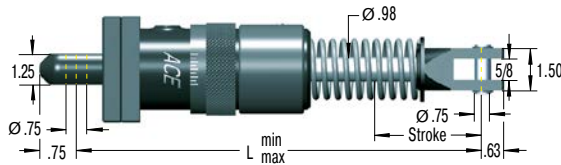

A1 1/2-S Foot Mount



The calculation and selection of the most suitable damper should be carried out or be approved by ACE.

Model Type Prefix

Standard Models

A: Self-contained with return spring, adjustable

Special Models

AA: Air/Oil return without return spring. Use only with external air/oil tank.

NA: Self-contained without return spring

SA: Air/Oil return with return spring. Use only with external air/oil tank.

Ordering Example

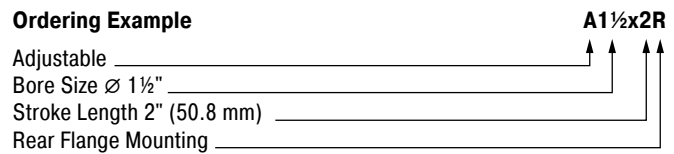

Dimensions

| TYPES | Stroke inch | L min. inch | L max. inch | L1 inch | L2 inch | L3 inch | L4 inch |
|------------|----------------|----------------|----------------|------------|------------|------------|------------|
| A11/2X2 | 2.00 | 10.94 | 12.94 | 7.69 | 2.13 | - | - |
| A11/2X31/2 | 3.50 | 12.46 | 15.97 | 9.19 | 2.13 | 6.69 | 2.31 |
| A11/2X5 | 5.00 | 13.97 | 18.97 | 10.69 | 2.13 | 8.19 | 2.31 |
| A11/2X61/2 | 6.50 | 16.22 | 22.72 | 12.94 | 2.88 | 9.69 | 3.06 |

Performance

| TYPES | Max. Energy Capacity | | | Effective Weight | | Return Force min. lbs | Return Force max. lbs | Return Time s | Side Load Angle max. ° | Weight lbs |
|------------|---|---|--|-----------------------------|-----------------------------|-----------------------------|-----------------------------|------------------|------------------------------|---------------|
| | ¹ E ₃ in-lbs/cycle | ² E ₄ in-lbs/h | ² E ₄ with Air/Oil Tank in-lbs/h | ³ We min. lbs | ³ We max. lbs | | | | | |
| A11/2X2 | 21,000 | 3,200,000 | 4,000,000 | 430 | 70,000 | 34.9 | 47.6 | 0.10 | 5 | 16.6 |
| A11/2X31/2 | 36,750 | 5,600,000 | 7,000,000 | 480 | 80,000 | 25.4 | 47.6 | 0.25 | 4 | 19.6 |
| A11/2X5 | 52,500 | 8,000,000 | 10,000,000 | 500 | 90,000 | 20.7 | 52.5 | 0.40 | 3 | 20.6 |
| A11/2X61/2 | 68,250 | 10,400,000 | 13,000,000 | 680 | 100,000 | 20.7 | 97.4 | 0.40 | 2 | 26.3 |

¹ For emergency use only applications it is sometimes possible to exceed the above ratings. Please consult ACE for further details.

² Figures for oil recirculation systems on request.

³ The effective weight range limits can be raised or lowered to special order.

Adjustable

A2-F Front Flange

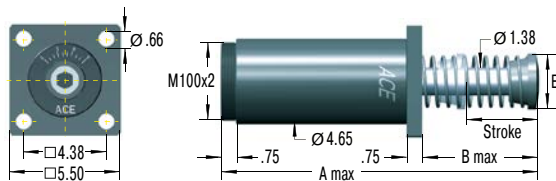

A2-R Rear Flange

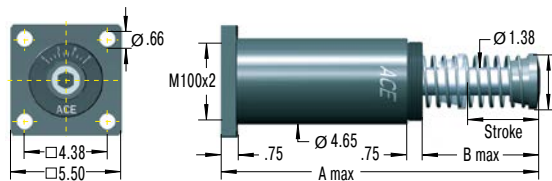

A2-C Clevis Mount

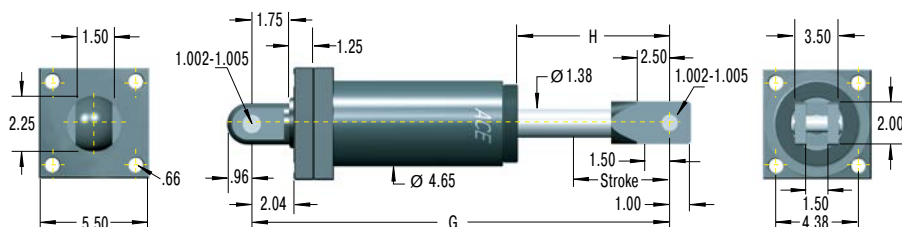

A2-S 2" Bore Foot Mount

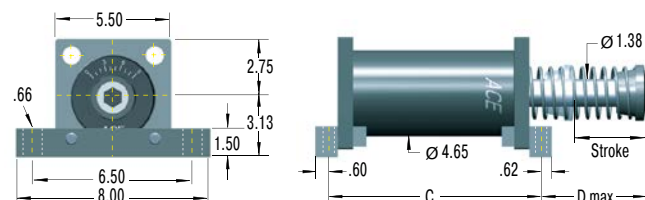

The calculation and selection of the most suitable damper should be carried out or be approved by ACE.

Model Type Prefix

Standard Models

A: Self-contained with return spring, adjustable

Special Models

AA: Air/Oil return without return spring. Use only with external air/oil tank.

NA: Self-contained without return spring

SA: Air/Oil return with return spring. Use only with external air/oil tank.

Ordering Example

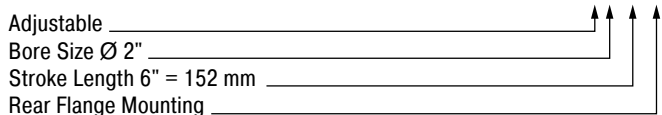

Dimensions

| TYPES | Stroke inch | A max. inch | B max. inch | C inch | D max. inch | E inch |
|-------|----------------|----------------|----------------|-----------|----------------|-----------|
| A2X2 | 2.00 | 12.37 | 4.37 | 9.28 | 3.74 | 2.73 |
| A2X4 | 4.00 | 16.37 | 6.31 | 11.28 | 5.74 | 2.73 |
| A2X6 | 6.00 | 20.37 | 8.37 | 13.28 | 7.74 | 2.73 |
| A2X8 | 8.00 | 25.37 | 11.37 | 15.28 | 10.74 | 3.63 |
| A2X10 | 10.00 | 29.37 | 13.37 | 17.28 | 12.74 | 4.25 |

Performance

| TYPES | Max. Energy Capacity | | | Effective Weight | | Return Force min. lbs | Return Force max. lbs | Return Time s | Side Load Angle max. ° | Weight lbs |
|-------|---|---|---|-----------------------------|-----------------------------|-----------------------------|-----------------------------|------------------|------------------------------|---------------|
| | ¹ E ₃ in-lbs/cycle | ² E ₄ in-lbs/h | ² E ₄ with Air/Oil Tank in-lbs/h | ³ We min. lbs | ³ We max. lbs | | | | | |
| A2X2 | 32,000 | 9,600,000 | 12,000,000 | 560 | 170,000 | 48 | 63 | 0.25 | 3 | 31.5 |
| A2X4 | 80,000 | 12,000,000 | 15,000,000 | 560 | 180,000 | 34 | 63 | 0.50 | 3 | 36.9 |
| A2X6 | 120,000 | 14,400,000 | 18,000,000 | 570 | 190,000 | 34 | 90 | 0.60 | 3 | 42.6 |
| A2X8 | 170,000 | 16,800,000 | 21,000,000 | 580 | 200,000 | 51 | 144 | 0.70 | 3 | 49.2 |
| A2X10 | 210,000 | 19,200,000 | 24,000,000 | 720 | 250,000 | 35 | 101 | 0.80 | 3 | 57.8 |

¹ For emergency use only applications it is sometimes possible to exceed the above ratings. Please consult ACE for further details.

² Figures for oil recirculation systems on request.

³ The effective weight range limits can be raised or lowered to special order.



A3-F Front Flange

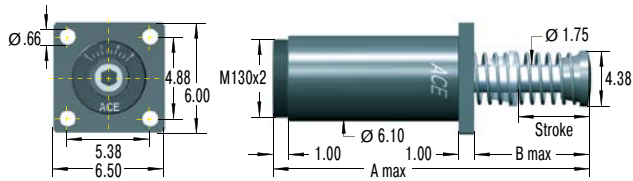

A3-R Rear Flange

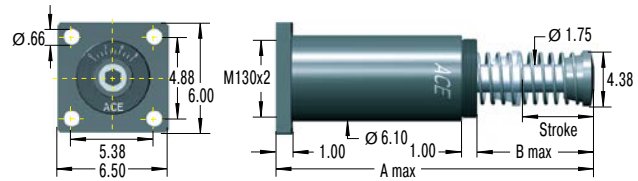

A3-C Clevis Mount

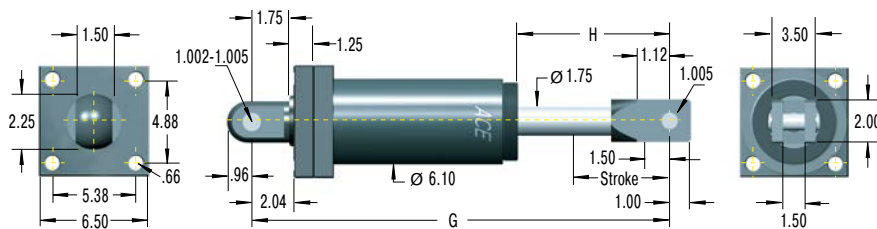

A3-S Foot Mount

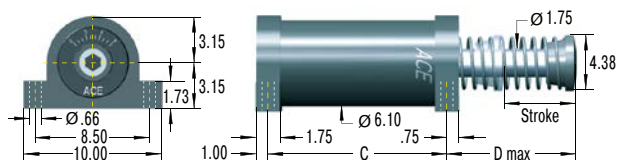

The calculation and selection of the most suitable damper should be carried out or be approved by ACE.

Model Type Prefix

Standard Models

A: Self-contained with return spring, adjustable

Special Models

AA: Air/Oil return without return spring. Use only with external air/oil tank.

NA: Self-contained without return spring

SA: Air/Oil return with return spring. Use only with external air/oil tank.

Ordering Example

Adjustable _____ **A3x8R**
 Bore Size Ø 3" _____
 Stroke Length 8" (203 mm) _____
 Rear Flange Mounting _____

Dimensions

| TYPES | Stroke inch | A max. inch | B max. inch | C inch | D max. inch |
|-------|----------------|----------------|----------------|-----------|----------------|
| A3X5 | 5.00 | 19.31 | 8.31 | 9.95 | 8.81 |
| A3X8 | 8.00 | 25.31 | 11.31 | 12.95 | 11.81 |
| A3X12 | 12.00 | 35.09 | 17.09 | 16.95 | 17.59 |

Performance

| TYPES | Max. Energy Capacity | | | Effective Weight | | Return Force min. lbs | Return Force max. lbs | Return Time s | Side Load Angle max. ° | Weight lbs |
|-------|---|---|---|-----------------------------|-----------------------------|-----------------------------|-----------------------------|------------------|------------------------------|---------------|
| | ¹ E ₃ in-lbs/cycle | ² E ₄ in-lbs/h | ² E ₄ with Air/Oil Tank in-lbs/h | ³ We min. lbs | ³ We max. lbs | | | | | |
| A3X5 | 140,000 | 20,000,000 | 25,000,000 | 1,050 | 340,000 | 59 | 156 | 0.6 | 3 | 72.1 |
| A3X8 | 250,000 | 32,000,000 | 40,000,000 | 1,200 | 400,000 | 62 | 162 | 0.8 | 3 | 84.9 |
| A3X12 | 390,000 | 48,000,000 | 60,000,000 | 1,350 | 450,000 | 60 | 160 | 1.2 | 3 | 105.8 |

¹ For emergency use only applications it is sometimes possible to exceed the above ratings. Please consult ACE for further details.

² Figures for oil recirculation systems on request.

³ The effective weight range limits can be raised or lowered to special order.

Air/Oil Tanks for industrial shock absorbers

For high cycle rates and extreme temperatures with limited mounting space

Shock absorbers convert the introduced energy into heat. The more frequently a shock absorber is stressed per hour, the hotter the oil volume becomes over time. If the requirements placed on the impact frequency of a shock absorber are especially high, use of an air-oil tank is the solution.

Thanks to increased oil volume and resulting heat dissipation, the upper limit of the possible hourly energy capacity of the shock absorber increases significantly.

In addition, the air-oil tank provides an opportunity for controlled piston return if no permanent return force through an integrated spring in the shock absorber is desired.

Air/Oil Tanks AO

A01

Oil capacity 0.6 oz.
Material: Aluminium caps

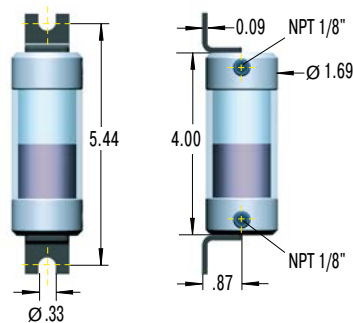

Detail drawings on request

A03

Oil capacity 12.5 oz.
Material: Steel

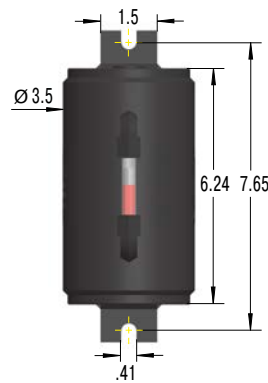

A06

Oil capacity 88 oz.
Material: Steel

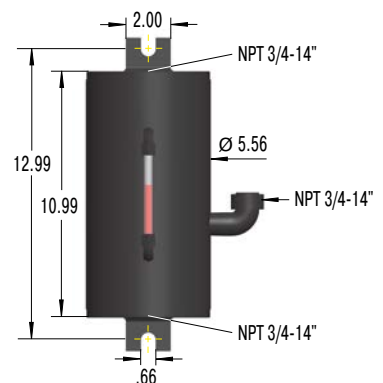

Technical Data

Operating pressure: Max. 8 bar (116 psi)
Operating temperature range: 176 °F
Damping medium: ATF-Oil 42 cSt at 104 °F
Mount air/oil tank higher than shock absorber.
Bleed all air from system before operating.

Safety instructions: Exhaust tank before carrying out service. Check valve holds pressure!

Suggested air/oil tanks in accordance with E₄ ratings

Connection Examples

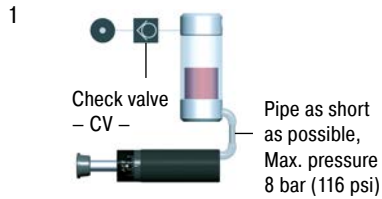

Piston rod returns immediately to extended position when load moves away. Operation without main air supply possible for short periods.

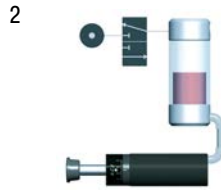

Return stroke may be sequenced by pneumatic valve at any desired time. No return force until valve energised.

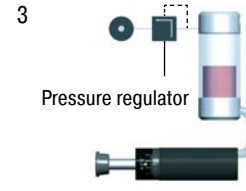

Return force can be adjusted by pressure regulator. Ensure safe minimum pressure to return shock absorber.



Spring return with air/oil tank. No air supply connected. Note: Will extend return time.

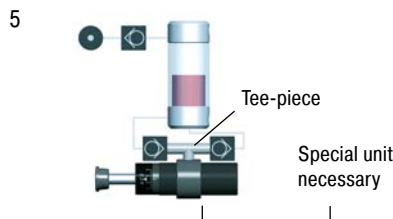

Oil recirculation circuit for extreme high cycle rates. Warm oil is positively circulated through air/oil tank for increased heat dissipation.

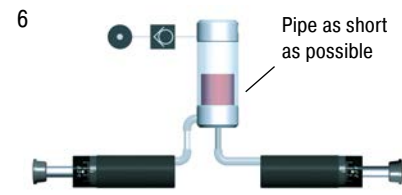

Connection of two shock absorbers to one air/oil tank is possible. Use next larger size tank. Combination with examples 2, 3 and 5 possible.

Selection Chart Air/Oil Tanks

| Shock Absorber Type | With Tank Example 1 to 4 | | With Recirc. Circuits Example 5 to 6 | | Min. Conn. Pipe Ø inch | Thread Sizes for Connection to Air/Oil Tank | |
|---------------------|-----------------------------|-------------|---|-------------|-------------------------------|--|--------------------------|
| | Tank | Check Valve | Tank | Check Valve | | Thread Bottom | ² Thread Side |
| MCA, MAA, MLA33... | AO1 | CV1/8 | AO3 | CV1/4 | 0.16 | ¹ 1/8-27 NPTF inside | 1/8-27 NPTF inside |
| MCA, MAA, MLA45... | AO1 | CV1/8 | AO3 | CV3/8 | 0.24 | 1/8-27 NPTF inside | 1/8-27 NPTF inside |
| MCA, MAA, MLA64... | AO3 | CV1/4 | AO6 | CV3/4 | 0.31 | 1/4-18 NPTF inside | 1/4-18 NPTF inside |
| CAA, AA2... | AO6 | CV3/4 | AO82 | CV3/4 | 0.59 | — | — |
| CAA, AA3... | AO6 | CV3/4 | AO82 | CV3/4 | 0.75 | — | — |
| CAA4... | AO82 | CV3/4 | AO82 | CV3/4 | 1.50 | — | — |

AO82 and connection accessories: Details on request

¹ adapted

² on request (add suffix -PG/-P)

Check Valves CV

Through an oil circuit fresh oil is drawn in from the industrial shock absorber and warm oil is pumped off (see example 5). To obtain this function, ACE offers suitable check valves of the CV series.

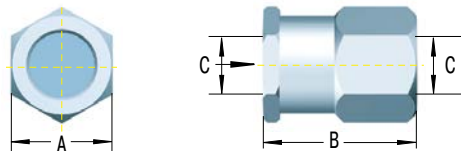

Technical Data

Operating pressure: 20 bar (290 psi)

Operating temperature range: 203 °F

Suitable for: Oil, air, water

Material: Aluminium

Check Valves – Dimensions

| TYPES | A inch | B inch | C |
|-------|-----------|-----------|------------|
| CV1/8 | 0.75 | 0.94 | 1/8-27 NPT |
| CV1/4 | 1.14 | 1.30 | 1/4-18 NPT |
| CV3/8 | 1.14 | 1.30 | 3/8-18 NPT |
| CV1/2 | 1.61 | 1.57 | 1/2-14 NPT |
| CV3/4 | 1.89 | 2.32 | 3/4-14 NPT |

Profile Dampers

The low cost alternative for continuous duty

The exceedingly successful TUBUS series from ACE is a perfect alternative, when masses don't need to be decelerated to an exact point. Available in more than 140 different versions, the profile dampers are used to slow down masses, particularly under extreme conditions.

They are also recommended for use if there is little installation space available. Manufactured in co-polyester elastomer, the highly resistant absorbers provide the best benefits in areas where other materials fail or where a high service life of up to 1 million cycles is required. They are affordable, compact, light and absorb energy with different damping characteristics depending on the design.

Competitive price/performance ratio

Reliable in extreme situations

Highly resistant material

Compact and lightweight design

Easy to mount

Long service life



Physical Properties of TUBUS Profile Dampers

ACE TUBUS profile dampers are high performance damping elements made from a special Co-Polyester Elastomer. They have a high energy absorbing capacity compared with other materials.

The excellent damping characteristics are achieved as a result of the special elastomer material and the worldwide unique construction design. This enables us to change the characteristics of the elastomer material so that individual and distinct damping curves are possible.

TUBUS dampers offer a considerable performance advantage when compared to other materials such as rubber, urethanes (PUR) and steel springs.

An advantage over other damping elements is TUBUS' operating life expectancy – up to twenty times longer than with urethane dampers, up to ten times longer than with rubber dampers and up to five times longer than with steel spring dampers.

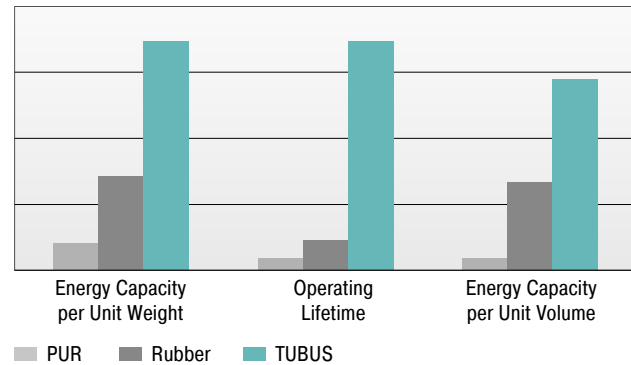

Comparison of Damping Characteristics

The innovative TUBUS dampers absorb energy while exhibiting the following damping characteristics:

Product family TA

Degressive characteristic with max. energy absorption with min. stroke.

Energy absorption: 58 % to 73 %

Product family TS

Almost linear characteristic with low reaction force over a short operating stroke.

Energy absorption: 35 % to 64 %

Product family TR/TR-L/TR-H

Progressive characteristic with gradually increasing reaction force over a long stroke.

Energy absorption TR: 25 % to 45 %

Energy absorption TR-L: 26 % to 41 %

Energy absorption TR-H: 39 % to 62 %

Product family TR-HD

Progressive characteristic with high energy absorption with a short stroke.

Energy absorption: 43 % to 72 %

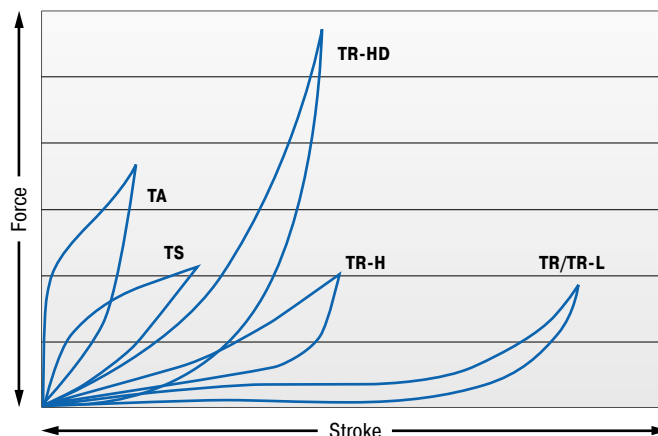

Characteristics of dynamic energy absorption for impact velocity over 1.64 ft/s.

or impact velocities under 1.64 ft/s, please request a static characteristic curve.

Issue 04.2018 – Specifications subject to change



TUBUS TA, TS, TR, TR-H, TR-HD

| TYPES | Max. Energy Capacity | | Stroke max. inch | Page |
|-----------|---|--|---------------------|------|
| | ¹ E ₃ in-lbs/cycle | Emergency Stop E ₃ in-lbs/cycle | | |
| TA12-5 | 17.7 | 26.6 | 0.20 | 117 |
| TA17-7 | 53.1 | 79.7 | 0.28 | 117 |
| TA21-9 | 88.5 | 142 | 0.35 | 117 |
| TA22-10 | 102 | 186 | 0.39 | 117 |
| TA28-12 | 257 | 407 | 0.47 | 117 |
| TA34-14 | 425 | 770 | 0.55 | 117 |
| TA37-16 | 575 | 991 | 0.63 | 117 |
| TA40-16 | 726 | 1,151 | 0.63 | 117 |
| TA43-18 | 991 | 1,460 | 0.71 | 117 |
| TA47-20 | 1,239 | 1,531 | 0.79 | 117 |
| TA50-22 | 1,505 | 1,974 | 0.87 | 117 |
| TA54-22 | 1,779 | 2,956 | 0.87 | 117 |
| TA57-24 | 2,142 | 2,673 | 0.94 | 117 |
| TA62-25 | 2,691 | 3,195 | 0.98 | 117 |
| TA65-27 | 3,310 | 4,142 | 1.06 | 117 |
| TA70-29 | 3,726 | 4,638 | 1.14 | 117 |
| TA72-31 | 4,266 | 4,948 | 1.22 | 117 |
| TA80-32 | 5,045 | 7,355 | 1.26 | 117 |
| TA82-35 | 6,045 | 8,152 | 1.38 | 117 |
| TA85-36 | 7,054 | 9,231 | 1.42 | 117 |
| TA90-38 | 8,267 | 11,055 | 1.50 | 117 |
| TA98-40 | 10,152 | 13,763 | 1.57 | 117 |
| TA116-48 | 17,825 | 26,119 | 1.89 | 117 |
| TS14-7 | 17.7 | 26.6 | 0.28 | 119 |
| TS18-9 | 35.4 | 53.1 | 0.35 | 119 |
| TS20-10 | 53.1 | 62.0 | 0.39 | 119 |
| TS26-15 | 102 | 133 | 0.59 | 119 |
| TS32-16 | 204 | 230 | 0.63 | 119 |
| TS35-19 | 266 | 319 | 0.75 | 119 |
| TS40-19 | 301 | 372 | 0.75 | 119 |
| TS41-21 | 425 | 558 | 0.83 | 119 |
| TS44-23 | 558 | 637 | 0.91 | 119 |
| TS48-25 | 717 | 805 | 0.98 | 119 |
| TS51-27 | 814 | 1,009 | 1.06 | 119 |
| TS54-29 | 1,080 | 1,398 | 1.14 | 119 |
| TS58-30 | 1,319 | 1,363 | 1.18 | 119 |
| TS61-32 | 1,443 | 1,496 | 1.26 | 119 |
| TS64-34 | 1,841 | 2,248 | 1.34 | 119 |
| TS68-36 | 2,009 | 2,407 | 1.42 | 119 |
| TS75-39 | 2,576 | 3,611 | 1.54 | 119 |
| TS78-40 | 3,115 | 4,062 | 1.57 | 119 |
| TS82-44 | 3,708 | 5,487 | 1.73 | 119 |
| TS84-43 | 4,204 | 5,620 | 1.69 | 119 |
| TS90-47 | 5,133 | 6,886 | 1.85 | 119 |
| TS107-56 | 7,983 | 8,550 | 2.20 | 119 |
| TR29-17 | 10.6 | 15.9 | 0.67 | 121 |
| TR37-22 | 20.4 | 47.8 | 0.87 | 121 |
| TR43-25 | 31.0 | 71.7 | 0.98 | 121 |
| TR50-35 | 51.3 | 73.4 | 1.38 | 121 |
| TR63-43 | 106 | 150 | 1.69 | 121 |
| TR67-40 | 204 | 292 | 1.57 | 121 |
| TR76-46 | 305 | 381 | 1.81 | 121 |
| TR83-50 | 398 | 655 | 1.97 | 121 |
| TR85-50 | 602 | 814 | 1.97 | 121 |
| TR93-57 | 814 | 1,080 | 2.24 | 121 |
| TR100-60 | 1,018 | 1,292 | 2.36 | 121 |
| TR30-15H | 23.9 | 50.5 | 0.59 | 123 |
| TR39-19H | 53.1 | 159 | 0.75 | 123 |
| TR45-23H | 77.0 | 212 | 0.91 | 123 |
| TR52-32H | 104 | 177 | 1.26 | 123 |
| TR64-41H | 221 | 407 | 1.61 | 123 |
| TR68-37H | 589 | 867 | 1.46 | 123 |
| TR79-42H | 721 | 938 | 1.65 | 123 |
| TR86-45H | 1,097 | 1,823 | 1.77 | 123 |
| TR87-46H | 1,398 | 2,310 | 1.81 | 123 |
| TR95-50H | 2,018 | 3,027 | 1.97 | 123 |
| TR102-56H | 2,567 | 3,779 | 2.20 | 123 |
| TR42-14HD | 3,585 | 5,018 | 0.58 | 127 |
| TR47-12HD | 7,585 | 10,621 | 0.48 | 127 |
| TR47-17HD | 7,523 | 10,532 | 0.67 | 127 |
| TR52-14HD | 14,462 | 20,250 | 0.47 | 127 |
| TR57-21HD | 10,568 | 14,798 | 0.86 | 127 |

TUBUS TA, TS, TR, TR-H, TR-HD

| TYPES | Max. Energy Capacity | | Stroke max. inch | Page |
|------------|---|--|---------------------|------|
| | ¹ E ₃ in-lbs/cycle | Emergency Stop E ₃ in-lbs/cycle | | |
| TR62-15HD | 15,843 | 22,180 | 0.62 | 127 |
| TR62-19HD | 26,021 | 36,430 | 0.66 | 127 |
| TR63-24HD | 18,241 | 25,534 | 0.97 | 127 |
| TR72-26HD | 15,046 | 21,065 | 1.04 | 127 |
| TR79-20HD | 24,729 | 34,624 | 0.82 | 127 |
| TR79-31HD | 26,331 | 36,863 | 1.17 | 127 |
| TR85-33HD | 22,357 | 31,296 | 1.26 | 127 |
| TR89-21HD | 39,280 | 54,990 | 0.85 | 127 |
| TR90-37HD | 33,456 | 46,838 | 1.48 | 127 |
| TR93-24HD | 30,278 | 42,386 | 0.96 | 127 |
| TR97-31HD | 68,487 | 95,880 | 1.00 | 127 |
| TR97-35HD | 24,968 | 34,952 | 1.50 | 127 |
| TR102-44HD | 41,572 | 58,202 | 1.74 | 127 |
| TR105-28HD | 49,927 | 69,894 | 1.02 | 127 |
| TR117-30HD | 74,851 | 104,793 | 1.09 | 127 |

¹ Max. energy capacity per cycle for continuous use.

TUBUS TR-L

| TYPES | Max. Energy Capacity | | Stroke max. inch | Page |
|--------------|---|--|---------------------|------|
| | ¹ E ₃ in-lbs/cycle | Emergency Stop E ₃ in-lbs/cycle | | |
| TR29-17L | 63.7 | 96 | 0.67 | 125 |
| TR43-25L | 124 | 289 | 0.98 | 125 |
| TR63-43L | 194 | 283 | 1.69 | 125 |
| TR66-40L-1 | 903 | 1,266 | 1.57 | 125 |
| TR66-40L-2 | 1,806 | 2,531 | 1.57 | 125 |
| TR66-40L-3 | 2,708 | 3,788 | 1.57 | 125 |
| TR66-40L-4 | 3,611 | 5,054 | 1.57 | 125 |
| TR66-40L-5 | 4,514 | 6,319 | 1.57 | 125 |
| TR76-45L-1 | 1,283 | 1,797 | 1.77 | 125 |
| TR76-45L-2 | 2,567 | 3,593 | 1.77 | 125 |
| TR76-45L-3 | 3,850 | 5,390 | 1.77 | 125 |
| TR76-45L-4 | 5,133 | 7,187 | 1.77 | 125 |
| TR76-45L-5 | 6,417 | 8,984 | 1.77 | 125 |
| TR83-48L-1 | 1,593 | 2,230 | 1.89 | 125 |
| TR83-48L-2 | 3,186 | 4,461 | 1.89 | 125 |
| TR83-48L-3 | 4,779 | 6,691 | 1.89 | 125 |
| TR83-48L-4 | 6,373 | 8,922 | 1.89 | 125 |
| TR83-48L-5 | 7,966 | 11,152 | 1.89 | 125 |
| TR99-60L-1 | 2,390 | 3,346 | 2.36 | 125 |
| TR99-60L-2 | 4,779 | 6,691 | 2.36 | 125 |
| TR99-60L-3 | 7,169 | 10,037 | 2.36 | 125 |
| TR99-60L-4 | 9,559 | 13,382 | 2.36 | 125 |
| TR99-60L-5 | 11,949 | 16,728 | 2.36 | 125 |
| TR99-60L-6 | 14,338 | 20,073 | 2.36 | 125 |
| TR99-60L-7 | 16,728 | 23,419 | 2.36 | 125 |
| TR143-86L-1 | 5,310 | 7,435 | 3.39 | 125 |
| TR143-86L-2 | 10,621 | 14,869 | 3.39 | 125 |
| TR143-86L-3 | 15,931 | 22,304 | 3.39 | 125 |
| TR143-86L-4 | 21,242 | 29,738 | 3.39 | 125 |
| TR143-86L-5 | 26,552 | 37,173 | 3.39 | 125 |
| TR143-86L-6 | 31,863 | 44,608 | 3.39 | 125 |
| TR143-86L-7 | 37,173 | 52,042 | 3.39 | 125 |
| TR188-108L-1 | 9,736 | 13,630 | 4.25 | 125 |
| TR188-108L-2 | 19,472 | 27,260 | 4.25 | 125 |
| TR188-108L-3 | 29,207 | 40,890 | 4.25 | 125 |
| TR188-108L-4 | 38,943 | 54,521 | 4.25 | 125 |
| TR188-108L-5 | 48,679 | 68,151 | 4.25 | 125 |
| TR188-108L-6 | 58,415 | 81,781 | 4.25 | 125 |
| TR188-108L-7 | 68,151 | 95,411 | 4.25 | 125 |

¹ Max. energy capacity per cycle for continuous use.

Profile Dampers



TUBUS TA

Axial Damping

Compact size and strong force absorption

Linear slides, Pneumatic cylinders, Handling modules, Machines and plants

Page 116



TUBUS TS

Axial Soft Damping

Compact size and smooth deceleration

Linear slides, Pneumatic cylinders, Handling modules, Machines and plants

Page 118



TUBUS TR

Radial Damping

Compact size and soft deceleration

Furniture industry, Sports equipment, Linear slides, Pneumatic cylinders

Page 120



TUBUS TR-H

Radial Damping, Hard Version

Compact size with soft deceleration and high energy absorption

Furniture industry, Sports equipment, Linear slides, Pneumatic cylinders

Page 122



TUBUS TR-L

Radial Damping, Long Version

Powerhouse in long body length

Offshore industry, Agricultural machinery, Impact panels, Conveyor systems

Page 124



TUBUS TR-HD

Radial Damping, Heavy Duty Version

Compact powerhouse in solid material

Offshore industry, Agricultural machinery, Impact panels, Conveyor systems

Page 126

TUBUS TA

Compact size and strong force absorption

Axial Damping

Energy capacity 17.7 in-lbs/Cycle to 17,825 in-lbs/Cycle

Maximum stroke 0.20 in to 1.89 in

Very efficient energy guzzlers: The TA profile dampers from the ACE TUBUS-Series are maintenance-free and ready to install. They're made of co-polyester elastomer; a material that only heats up slightly and ensures consistent damping. The TA models absorb most of the energy at the start of the stroke.

The TA family has been specially developed for maximum energy absorption within a range of 18 in-lbs to 26,119 in-lbs. (2 Nm to 2,951 Nm). These dampers have a minimum height is thanks to the space-saving shape, with \varnothing 0.47" to \varnothing 4.57" (\varnothing 12 mm to \varnothing 116 mm). The dampers can be very easily and quickly installed with the provided special screw.

These compact, cost-effective dampers are ideal as end position dampers in linear axes, in toolmaking and tool machines, in hydraulic and pneumatic equipment, handling equipment and other applications.



Technical Data

Energy capacity: 17.7 in-lbs/Cycle to 17,825 in-lbs/Cycle

Energy absorption: 58 % to 73 %

Dynamic force range: 196 lbs to 20,233 lbs

Operating temperature range: -40 °F to 194 °F

Construction size: 0.47 in to 4.57 in

Mounting: In any position

Material hardness rating: Shore 55D

Material: Profile body: Co-Polyester Elastomer

Environment: Resistant to microbes, seawater or chemical attack. Excellent UV and ozone resistance. Material does not absorb water or swell.

Impact velocity range: Max. 16.4 ft/sec

Torque max.:

M3: 0.74 ft-lbs

M4: 1.25 ft-lbs

M5: 1.70 ft-lbs

M6: 4.43 ft-lbs

M8: 14.75 ft-lbs

M12: 36.88 ft-lbs

M16: 88.51 ft-lbs

Application field: Linear slides, Pneumatic cylinders, Handling modules, Machines and plants, Swivel units, Electro-mechanical drives, Hydraulic devices, Conveyor systems, Crane systems

Note: Suitable for emergency stop applications and for continuous use. For applications with preloading and increased temperatures please consult ACE.

Safety information: Mounting screw should additionally be secured with Loctite.

On request: Special strokes, -characteristics, -spring rates, -sizes and -materials.

TA

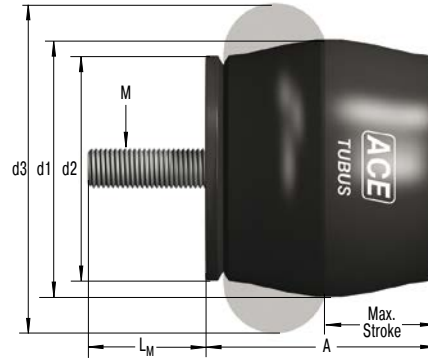

Characteristics

Type TA37-16
Energy-Stroke Characteristic (dynamic)
 (with impact velocity over 1.64 ft/s)

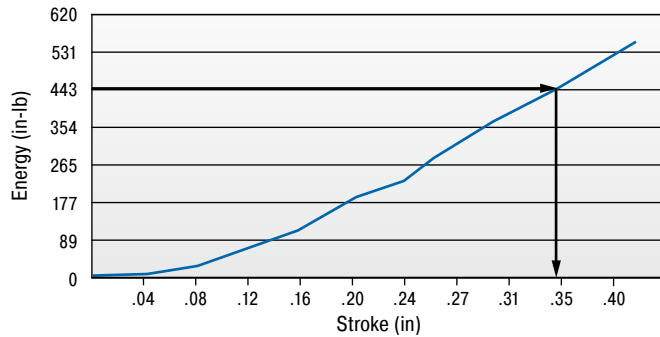

Type TA37-16
Force-Stroke Characteristic (dynamic)
 (with impact velocity over 1.64 ft/s)

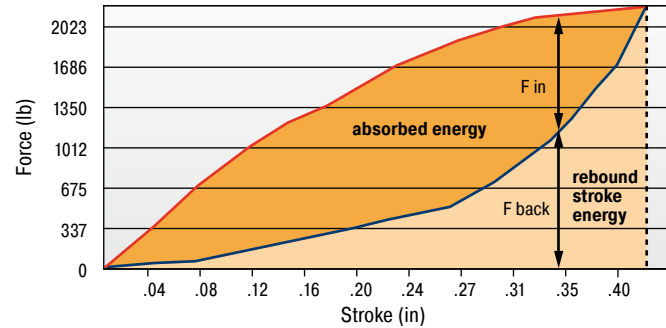

With the aid of the characteristic curves above you can estimate the proportion of the total energy that will be absorbed.
 Example: With impact energy of 443 lbs the Energy-Stroke diagram shows that a stroke of about 0.35 in is needed.
 On the Force-Stroke diagram you can estimate the proportion of absorbed energy to rebound energy at this stroke length.

Dynamic ($v > 1.64$ ft/s) and static ($v \leq 1.64$ ft/s) characteristics of all types are available on request.

The calculation and selection of the most suitable damper should be carried out or be approved by ACE.

Ordering Example

TUBUS Axial _____ **TA37-16**
 Outer- \varnothing 1.46" (37 mm) _____
 Stroke 0.63" (16 mm) _____

Performance and Dimensions

| TYPES | Emergency Stop | | Stroke max. inch | A inch | d1 inch | d2 inch | d3 inch | L _m inch | M | Weight lbs |
|----------|---|--------------------------------|---------------------|-----------|------------|------------|------------|------------------------|-----|---------------|
| | ¹ E ₃ in-lbs/cycle | E ₃ in-lbs/cycle | | | | | | | | |
| TA12-5 | 17.7 | 26.6 | 0.20 | 0.43 | 0.47 | 0.43 | 0.59 | 0.12 | M3 | 0.003 |
| TA17-7 | 53.1 | 79.7 | 0.28 | 0.63 | 0.67 | 0.59 | 0.87 | 0.16 | M4 | 0.013 |
| TA21-9 | 88.5 | 142 | 0.35 | 0.71 | 0.83 | 0.71 | 1.02 | 0.20 | M5 | 0.038 |
| TA22-10 | 102 | 186 | 0.39 | 0.75 | 0.87 | 0.75 | 1.06 | 0.24 | M6 | 0.019 |
| TA28-12 | 257 | 407 | 0.47 | 1.02 | 1.10 | 0.98 | 1.42 | 0.24 | M6 | 0.035 |
| TA34-14 | 425 | 770 | 0.55 | 1.18 | 1.34 | 1.18 | 1.69 | 0.24 | M6 | 0.052 |
| TA37-16 | 575 | 991 | 0.63 | 1.30 | 1.46 | 1.30 | 1.89 | 0.24 | M6 | 0.067 |
| TA40-16 | 726 | 1,151 | 0.63 | 1.38 | 1.57 | 1.34 | 1.97 | 0.31 | M8 | 0.088 |
| TA43-18 | 991 | 1,460 | 0.71 | 1.50 | 1.69 | 1.50 | 2.17 | 0.31 | M8 | 0.113 |
| TA47-20 | 1,239 | 1,531 | 0.79 | 1.61 | 1.85 | 1.61 | 2.36 | 0.47 | M12 | 0.154 |
| TA50-22 | 1,505 | 1,974 | 0.87 | 1.77 | 1.97 | 1.73 | 2.52 | 0.47 | M12 | 0.187 |
| TA54-22 | 1,779 | 2,956 | 0.87 | 1.85 | 2.13 | 1.85 | 2.68 | 0.47 | M12 | 0.220 |
| TA57-24 | 2,142 | 2,673 | 0.94 | 2.01 | 2.24 | 1.97 | 2.87 | 0.47 | M12 | 0.256 |
| TA62-25 | 2,691 | 3,195 | 0.98 | 2.13 | 2.44 | 2.09 | 3.07 | 0.47 | M12 | 0.291 |
| TA65-27 | 3,310 | 4,142 | 1.06 | 2.28 | 2.56 | 2.24 | 3.23 | 0.47 | M12 | 0.338 |
| TA70-29 | 3,726 | 4,638 | 1.14 | 2.40 | 2.76 | 2.36 | 3.39 | 0.47 | M12 | 0.385 |
| TA72-31 | 4,266 | 4,948 | 1.22 | 2.56 | 2.83 | 2.48 | 3.58 | 0.63 | M16 | 0.566 |
| TA80-32 | 5,045 | 7,355 | 1.26 | 2.72 | 3.15 | 2.72 | 3.94 | 0.63 | M16 | 0.687 |
| TA82-35 | 6,045 | 8,152 | 1.38 | 2.91 | 3.23 | 2.83 | 4.13 | 0.63 | M16 | 0.773 |
| TA85-36 | 7,054 | 9,231 | 1.42 | 2.99 | 3.35 | 2.95 | 4.33 | 0.63 | M16 | 0.863 |
| TA90-38 | 8,267 | 11,055 | 1.50 | 3.15 | 3.54 | 3.07 | 4.49 | 0.63 | M16 | 0.912 |
| TA98-40 | 10,152 | 13,763 | 1.57 | 3.39 | 3.86 | 3.35 | 4.84 | 0.63 | M16 | 1.131 |
| TA116-48 | 17,825 | 26,119 | 1.89 | 3.98 | 4.57 | 3.86 | 5.75 | 0.63 | M16 | 1.770 |

¹ Max. energy capacity per cycle for continuous use.

TUBUS TS

Compact size and smooth deceleration

Axial Soft Damping

Energy capacity 17.7 in-lbs/Cycle to 7,983 in-lbs/Cycle

Maximum stroke 0.28 in to 2.20 in

Energy absorption in a compact and uniform way: The TS (TUBUS soft) profile dampers are also manufactured from co-polyester elastomer. Due to the almost linear damping characteristic curve, the maintenance-free, ready-to-install components softly absorb the energy with minimum stress on the machine. Consistent damping is helped by the low temperature increase of the material during operation.

The TS product family impresses with maximum energy absorption within a range of 17.7 in-lbs to 8,549 in-lbs (2 Nm to 966 Nm) within a minimum height. The space-saving design has been implemented from Ø 0.55" to Ø 4.21" (Ø 14 mm to Ø 107 mm). The special screw supplied is used to simply and quickly secure the profile dampers in place.

Suitable for emergency stop and permanent applications, the cost-effective, durable TUBUS TS can be used as end position dampers in linear axes, in tool making and tool machines and in hydraulic, pneumatic and handling equipment.



Technical Data

Energy capacity: 17.7 in-lbs/Cycle to 7,983 in-lbs/Cycle

Energy absorption: 35 % to 64 %

Dynamic force range: 120 lbs to 5,283 lbs

Operating temperature range: -40 °F to 194 °F

Construction size: 0.55 in to 4.21 in

Mounting: In any position

Material hardness rating: Shore 40D

Material: Profile body: Co-Polyester Elastomer

Environment: Resistant to microbes, seawater or chemical attack. Excellent UV and ozone resistance. Material does not absorb water or swell.

Impact velocity range: Max. 16.4 ft/sec

Torque max.:

M4: 1.25 ft-lbs

M5: 1.70 ft-lbs

M6: 4.43 ft-lbs

M12: 36.88 ft-lbs

M16: 88.51 ft-lbs

Application field: Linear slides, Pneumatic cylinders, Handling modules, Machines and plants, Swivel units, Electro-mechanical drives, Crane systems, Conveyor systems

Note: Suitable for emergency stop applications and for continuous use. For applications with preloading and increased temperatures please consult ACE.

Safety information: Mounting screw should additionally be secured with Loctite.

On request: Special strokes, -characteristics, -spring rates, -sizes and -materials.

TS

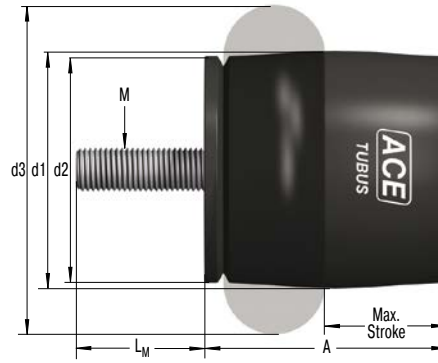

Characteristics

Type TS44-23

Energy-Stroke Characteristic (dynamic)
(with impact velocity over 1.64 ft/s)

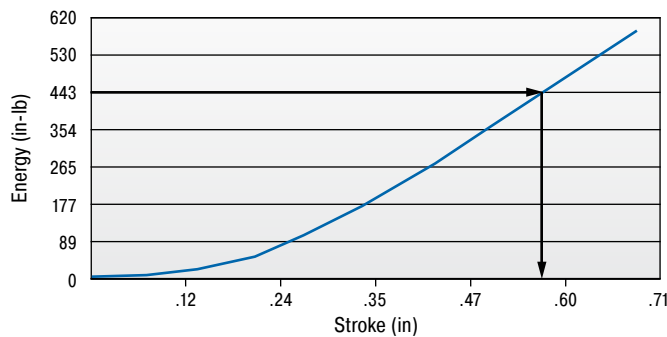

Type TS44-23

Force-Stroke Characteristic (dynamic)
(with impact velocity over 1.64 ft/s)

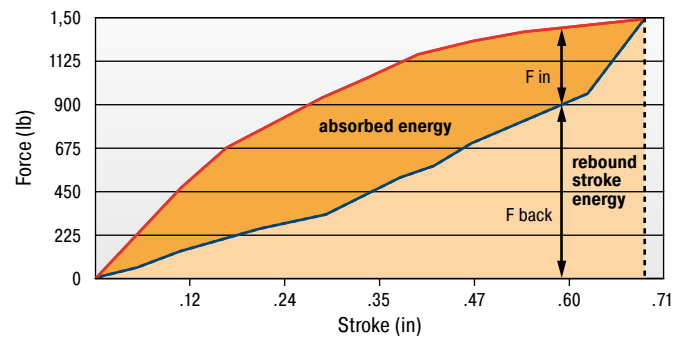

With the aid of the characteristic curves above you can estimate the proportion of the total energy that will be absorbed.
 Example: With impact energy of 443 lbs the Energy-Stroke diagram shows that a stroke of about 0.55 in is needed.
 On the Force-Stroke diagram you can estimate the proportion of absorbed energy to rebound energy at this stroke length.
Dynamic ($v > 1.64$ ft/s) and static ($v \leq 1.64$ ft/s) characteristics of all types are available on request.

The calculation and selection of the most suitable damper should be carried out or be approved by ACE.

Ordering Example

TUBUS Axial Soft _____ **TS44-23**
 Outer- \varnothing 1.73" (44 mm) _____
 Stroke 0.91" (23 mm) _____

Performance and Dimensions

| TYPES | Emergency Stop | | Stroke max. inch | A inch | d1 inch | d2 inch | d3 inch | L _m inch | M | Weight lbs |
|----------|---|--------------------------------|---------------------|-----------|------------|------------|------------|------------------------|-----|---------------|
| | ¹ E ₃ in-lbs/cycle | E ₃ in-lbs/cycle | | | | | | | | |
| TS14-7 | 17.7 | 26.6 | 0.28 | 0.59 | 0.55 | 0.51 | 0.75 | 0.16 | M4 | 0.015 |
| TS18-9 | 35.4 | 53.1 | 0.35 | 0.71 | 0.71 | 0.63 | 0.94 | 0.20 | M5 | 0.017 |
| TS20-10 | 53.1 | 62.0 | 0.39 | 0.83 | 0.79 | 0.75 | 1.06 | 0.24 | M6 | 0.017 |
| TS26-15 | 102 | 133 | 0.59 | 1.10 | 1.02 | 0.98 | 1.46 | 0.24 | M6 | 0.032 |
| TS32-16 | 204 | 230 | 0.63 | 1.26 | 1.26 | 1.18 | 1.73 | 0.24 | M6 | 0.046 |
| TS35-19 | 266 | 319 | 0.75 | 1.42 | 1.38 | 1.30 | 1.89 | 0.24 | M6 | 0.062 |
| TS40-19 | 301 | 372 | 0.75 | 1.50 | 1.57 | 1.34 | 2.01 | 0.24 | M6 | 0.068 |
| TS41-21 | 425 | 558 | 0.83 | 1.61 | 1.61 | 1.50 | 2.17 | 0.47 | M12 | 0.132 |
| TS44-23 | 558 | 637 | 0.91 | 1.77 | 1.73 | 1.57 | 2.36 | 0.47 | M12 | 0.154 |
| TS48-25 | 717 | 805 | 0.98 | 1.93 | 1.89 | 1.73 | 2.52 | 0.47 | M12 | 0.176 |
| TS51-27 | 814 | 1,009 | 1.06 | 2.05 | 2.01 | 1.85 | 2.72 | 0.47 | M12 | 0.209 |
| TS54-29 | 1,080 | 1,398 | 1.14 | 2.17 | 2.13 | 1.97 | 2.87 | 0.47 | M12 | 0.231 |
| TS58-30 | 1,319 | 1,363 | 1.18 | 2.32 | 2.28 | 2.09 | 3.07 | 0.47 | M12 | 0.266 |
| TS61-32 | 1,443 | 1,496 | 1.26 | 2.44 | 2.40 | 2.20 | 3.27 | 0.63 | M16 | 0.448 |
| TS64-34 | 1,841 | 2,248 | 1.34 | 2.60 | 2.52 | 2.36 | 3.43 | 0.63 | M16 | 0.512 |
| TS68-36 | 2,009 | 2,407 | 1.42 | 2.72 | 2.68 | 2.48 | 3.62 | 0.63 | M16 | 0.546 |
| TS75-39 | 2,576 | 3,611 | 1.54 | 2.95 | 2.95 | 2.72 | 3.98 | 0.63 | M16 | 0.664 |
| TS78-40 | 3,115 | 4,062 | 1.57 | 3.11 | 3.07 | 2.83 | 4.13 | 0.63 | M16 | 0.732 |
| TS82-44 | 3,708 | 5,487 | 1.73 | 3.31 | 3.23 | 2.95 | 4.33 | 0.63 | M16 | 0.762 |
| TS84-43 | 4,204 | 5,620 | 1.69 | 3.35 | 3.31 | 3.07 | 4.53 | 0.63 | M16 | 0.886 |
| TS90-47 | 5,133 | 6,886 | 1.85 | 3.62 | 3.54 | 3.31 | 4.88 | 0.63 | M16 | 1.286 |
| TS107-56 | 7,983 | 8,550 | 2.20 | 4.33 | 4.21 | 3.94 | 5.79 | 0.63 | M16 | 1.616 |

¹ Max. energy capacity per cycle for continuous use.

TUBUS TR

Compact size and soft deceleration

Radial Damping

Energy capacity 10.6 in-lbs/Cycle to 1,018 in-lbs/Cycle

Maximum stroke 0.67 in to 2.36 in

For long, soft braking action: The TUBUS TR models deliver linear damping forces. These maintenance-free, ready-to-install elements are made of co-polyester elastomer, which only heats up slightly during operation and therefore provides consistent damping.

The radial loading enables a very long and soft deceleration with progressive energy reduction at the end of the stroke. The TR product family has been specially designed for maximum stroke with a minimum height, producing energy absorption per stroke extending from 10.6 in-lbs to 1,292 in-lbs. (1.2 Nm to 146 Nm). The dampers are available in compact formats of Ø 1.14" to Ø 3.94" (Ø 29 mm to Ø 100 mm) and are supplied with a special screw for simple, quick assembly.

The TUBUS TR products are suitable as end position dampers in linear axes, in tool making and tool machines, in hydraulic and pneumatic equipment, handling equipment and other applications.



Technical Data

Energy capacity: 10.6 in-lbs/Cycle to 1,018 in-lbs/Cycle

Energy absorption: 25 % to 45 %

Dynamic force range: 49 lbs to 1,686 lbs

Operating temperature range: -40 °F to 194 °F

Construction size: 1.14 in to 3.93 in

Mounting: In any position

Material hardness rating: Shore 40D

Material: Profile body: Co-Polyester Elastomer

Environment: Resistant to microbes, seawater or chemical attack. Excellent UV and ozone resistance. Material does not absorb water or swell.

Impact velocity range: Max. 16.4 ft/sec

Torque max.:

M5: 2.21 ft-lbs

M6: 4.43 ft-lbs

M8: 14.75 ft-lbs

Application field: Furniture industry, Sports equipment, Linear slides, Pneumatic cylinders, Handling modules, Machines and plants, Stacking units, Electro-mechanical drives, Conveyor systems, Dock constructions for shipbuilding

Note: Suitable for emergency stop applications and for continuous use. For applications with preloading and increased temperatures please consult ACE.

Safety information: Mounting screw should additionally be secured with Loctite.

On request: Special strokes, -characteristics, -spring rates, -sizes and -materials.

TR

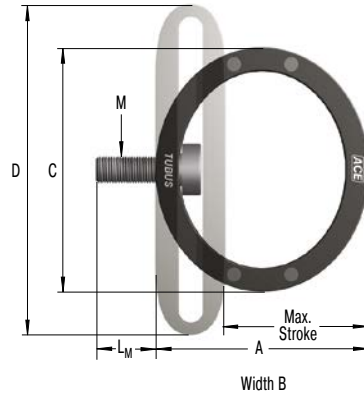

Characteristics

Type TR93-57

Energy-Stroke Characteristic (dynamic)
(with impact velocity over 1.64 ft/s)

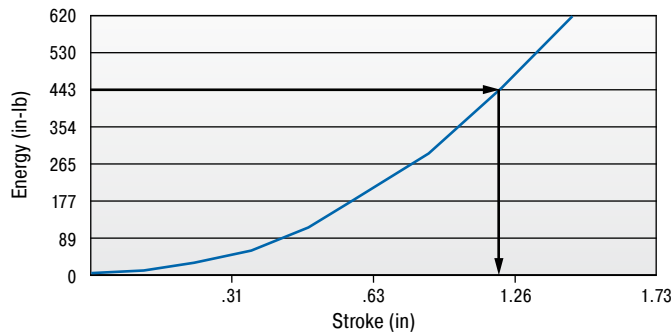

Type TR93-57

Force-Stroke Characteristic (dynamic)
(with impact velocity over 1.64 ft/s)

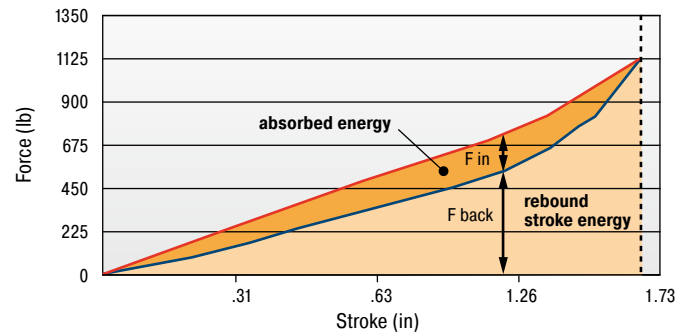

With the aid of the characteristic curves above you can estimate the proportion of the total energy that will be absorbed.
Example: With impact energy of 443 lbs the Energy-Stroke diagram shows that a stroke of about 1.22 in is needed.
On the Force-Stroke diagram you can estimate the proportion of absorbed energy to rebound energy at this stroke length.
Dynamic ($v > 1.64$ ft/s) and static ($v \leq 1.64$ ft/s) characteristics of all types are available on request.

The calculation and selection of the most suitable damper should be carried out or be approved by ACE.

Ordering Example

TUBUS Radial _____ **TR93-57**
Outer- \varnothing 3.66" (93 mm) _____
Stroke 2.24" (57 mm) _____

Performance and Dimensions

| TYPES | Emergency Stop | | Stroke max. inch | A inch | B inch | C inch | D inch | L _m inch | M | Weight lbs |
|----------|---|--------------------------------|---------------------|-----------|-----------|-----------|-----------|------------------------|----|---------------|
| | ¹ E ₃ in-lbs/cycle | E ₃ in-lbs/cycle | | | | | | | | |
| TR29-17 | 10.6 | 15.9 | 0.67 | 0.98 | 0.51 | 1.14 | 1.50 | 0.20 | M5 | 0.015 |
| TR37-22 | 20.4 | 47.8 | 0.87 | 1.26 | 0.75 | 1.46 | 1.97 | 0.20 | M5 | 0.028 |
| TR43-25 | 31.0 | 71.7 | 0.98 | 1.46 | 0.79 | 1.69 | 2.28 | 0.20 | M5 | 0.038 |
| TR50-35 | 51.3 | 73.4 | 1.38 | 1.73 | 1.34 | 1.97 | 2.68 | 0.20 | M5 | 0.048 |
| TR63-43 | 106 | 150 | 1.69 | 2.17 | 1.69 | 2.48 | 3.43 | 0.20 | M5 | 0.112 |
| TR67-40 | 204 | 292 | 1.57 | 2.32 | 1.81 | 2.64 | 3.46 | 0.20 | M5 | 0.170 |
| TR76-46 | 305 | 381 | 1.81 | 2.64 | 1.81 | 2.99 | 4.02 | 0.24 | M6 | 0.230 |
| TR83-50 | 398 | 655 | 1.97 | 2.87 | 2.01 | 3.27 | 4.29 | 0.24 | M6 | 0.313 |
| TR85-50 | 602 | 814 | 1.97 | 2.87 | 2.68 | 3.35 | 4.37 | 0.31 | M8 | 0.455 |
| TR93-57 | 814 | 1,080 | 2.24 | 3.27 | 3.27 | 3.66 | 4.88 | 0.31 | M8 | 0.655 |
| TR100-60 | 1,018 | 1,292 | 2.36 | 3.46 | 3.23 | 3.94 | 5.24 | 0.31 | M8 | 0.679 |

¹ Max. energy capacity per cycle for continuous use.

TUBUS TR-H

Compact size with soft deceleration and high energy absorption

Radial Damping, Hard Version

Energy capacity 23.9 in-lbs/Cycle to 2,567 in-lbs/Cycle

Maximum stroke 0.59 in to 2.20 in

Harder mixture of materials for higher energy absorption: The maintenance-free and ready-to-install TR-H profile dampers, are stressed radially in the same way as the basic TR model. With almost the same dimensions, they also decelerate with a very long and soft action. The harder co-polyester elastomer mixture leads to significantly high energy absorption of 23.9 in-lbs to 3,779 in-lbs (2.7 Nm to 427 Nm) in these models. The supplied special screw makes them easy to mount.

The TR-H product family is space-saving with dimensions of Ø 1.18" to Ø 4.02" (Ø 30 mm to Ø 102 mm). It complements the TUBUS range between the progressive TR and almost linear TS models. Users are therefore provided with a full range of deceleration curves within the ACE TUBUS family.

The TUBUS TR-H products are suitable end position dampers in linear axes, in tool making and tool machines and in hydraulic, pneumatic and handling equipment as well as other applications.



Technical Data

Energy capacity: 23.9 in-lbs/Cycle to 2,567 in-lbs/Cycle

Energy absorption: 39 % to 62 %

Dynamic force range: 124 lbs to 4,766 lbs

Operating temperature range: -40 °F to 194 °F

Construction size: 1.18 in to 4.01 in

Mounting: In any position

Material hardness rating: Shore 55D

Material: Profile body: Co-Polyester Elastomer

Environment: Resistant to microbes, seawater or chemical attack. Excellent UV and ozone resistance. Material does not absorb water or swell.

Impact velocity range: Max. 16.4 ft/sec

Torque max.:

M5: 2.21 ft-lbs

M6: 4.43 ft-lbs

M8: 14.75 ft-lbs

Application field: Furniture industry, Sports equipment, Linear slides, Pneumatic cylinders, Handling modules, Machines and plants, Stacking units, Electro-mechanical drives, Conveyor systems, Dock constructions for shipbuilding

Note: Suitable for emergency stop applications and for continuous use. For applications with preloading and increased temperatures please consult ACE.

Safety information: Mounting screw should additionally be secured with Loctite.

On request: Special strokes, -characteristics, -spring rates, -sizes and -materials.

TR-H

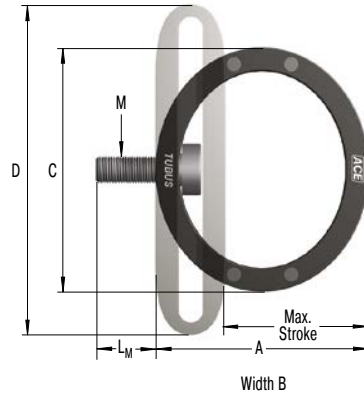

Characteristics

Type TR95-50H
Energy-Stroke Characteristic (dynamic)
(with impact velocity over 1.64 ft/s)

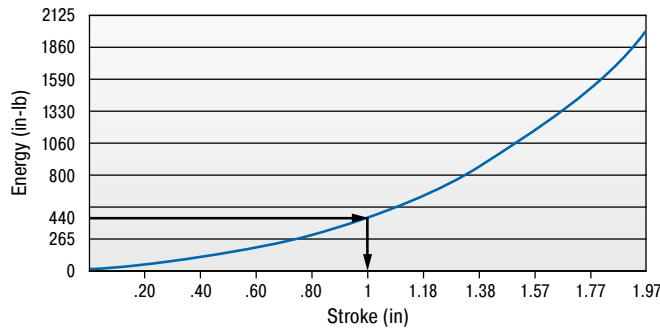

Type TR95-50H
Force-Stroke Characteristic (dynamic)
(with impact velocity over 1.64 ft/s)

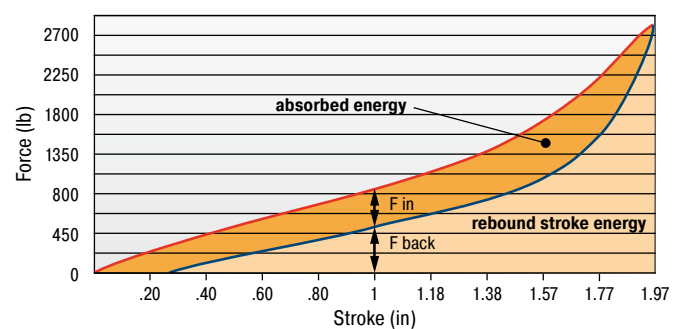

With the aid of the characteristic curves above you can estimate the proportion of the total energy that will be absorbed.
 Example: With impact energy of 443 lbs the Energy-Stroke diagram shows that a stroke of about 0.98 in is needed.
 On the Force-Stroke diagram you can estimate the proportion of absorbed energy to rebound energy at this stroke length.
Dynamic ($v > 1.64$ ft/s) and static ($v \leq 1.64$ ft/s) characteristics of all types are available on request.

The calculation and selection of the most suitable damper should be carried out or be approved by ACE.

Ordering Example

TUBUS Radial _____
 Outer- \varnothing 3.74" (95 mm) _____
 Stroke 1.97" (50 mm) _____
 Hard Version _____

TR95-50H

Performance and Dimensions

| TYPES | Emergency Stop | | Stroke max. inch | A inch | B inch | C inch | D inch | L _m inch | M | Weight lbs |
|-----------|---|--------------------------------|---------------------|-----------|-----------|-----------|-----------|------------------------|----|---------------|
| | ¹ E ₃ in-lbs/cycle | E ₃ in-lbs/cycle | | | | | | | | |
| TR30-15H | 23.9 | 50.5 | 0.59 | 0.91 | 0.51 | 1.18 | 1.50 | 0.20 | M5 | 0.013 |
| TR39-19H | 53.1 | 159 | 0.75 | 1.18 | 0.75 | 1.54 | 1.97 | 0.20 | M5 | 0.029 |
| TR45-23H | 77.0 | 212 | 0.91 | 1.42 | 0.79 | 1.77 | 2.28 | 0.20 | M5 | 0.042 |
| TR52-32H | 104 | 177 | 1.26 | 1.65 | 1.34 | 2.05 | 2.68 | 0.20 | M5 | 0.060 |
| TR64-41H | 221 | 407 | 1.61 | 2.09 | 1.69 | 2.52 | 3.43 | 0.20 | M5 | 0.119 |
| TR68-37H | 589 | 867 | 1.46 | 2.20 | 1.81 | 2.68 | 3.46 | 0.20 | M5 | 0.183 |
| TR79-42H | 721 | 938 | 1.65 | 2.52 | 1.81 | 3.11 | 4.02 | 0.24 | M6 | 0.235 |
| TR86-45H | 1,097 | 1,823 | 1.77 | 2.72 | 2.01 | 3.39 | 4.29 | 0.24 | M6 | 0.334 |
| TR87-46H | 1,398 | 2,310 | 1.81 | 2.68 | 2.64 | 3.39 | 4.37 | 0.31 | M8 | 0.446 |
| TR95-50H | 2,018 | 3,027 | 1.97 | 3.03 | 3.23 | 3.74 | 4.88 | 0.31 | M8 | 0.619 |
| TR102-56H | 2,567 | 3,779 | 2.20 | 3.31 | 3.19 | 4.02 | 5.24 | 0.31 | M8 | 0.736 |

¹ Max. energy capacity per cycle for continuous use.

TUBUS TR-L

Powerhouse in long body length

Radial Damping, Long Version

Energy capacity 63.7 in-lbs/Cycle to 68,151 in-lbs/Cycle

Maximum stroke 0.67 in to 4.25 in

Designed for applications with long and soft deceleration: The ACE TUBUS range TR-L radial tube dampers are maintenance-free, ready-to-install elements made of co-polyester elastomer.

Their radial load offers designers a very long and soft deceleration with a progressive reduction in energy at the end of the stroke. The TR-L range has been specially developed for a maximum stroke with a minimum height and a range of 63.7 in-lbs to 95,411 in-lbs (7.2 Nm to 10,780 Nm). The absorption capacity is dependent on the length of the selected tube damper. These models are available in sizes between \varnothing 1.14" and \varnothing 46.77" (\varnothing 29 mm and \varnothing 188 mm).

The TUBUS TR-L is used where impact or collision protection is necessary along a straight line e.g. on shovels in mining equipment, loading and lifting devices, dock systems in shipbuilding or luggage and transport belts.

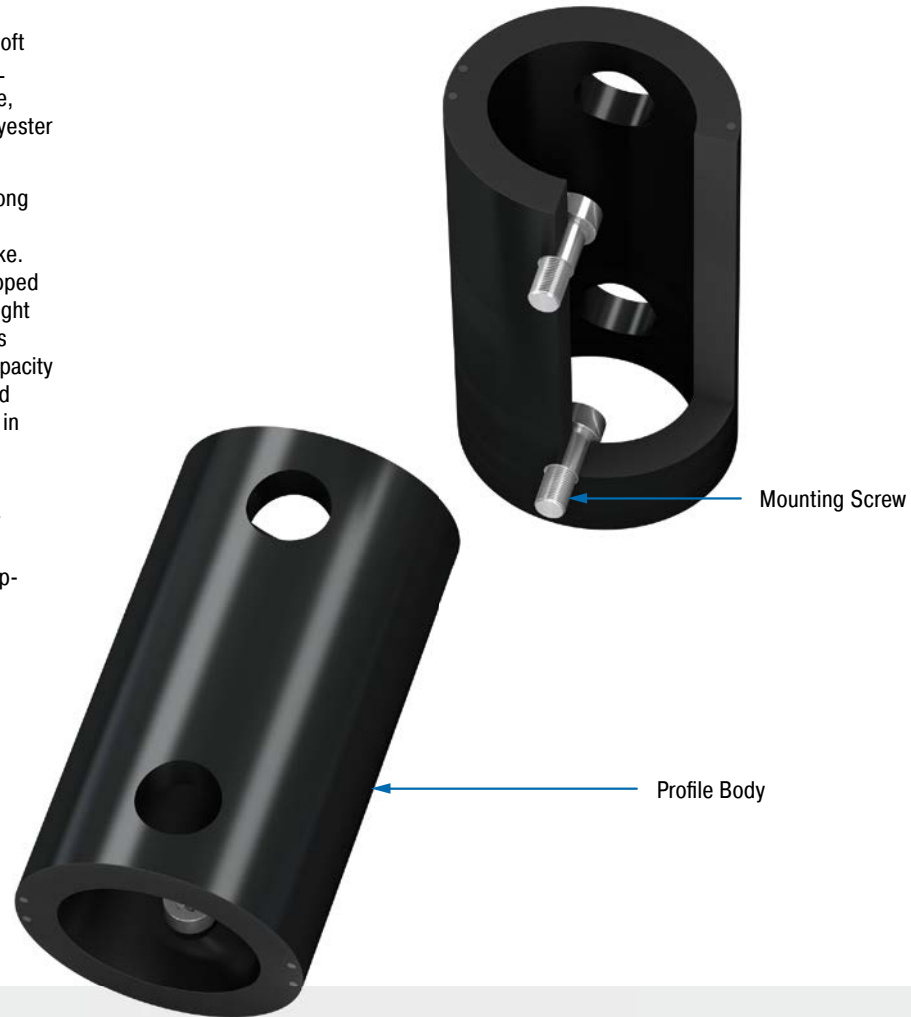

Technical Data

Energy capacity: 63.7 in-lbs/Cycle to 68,151 in-lbs/Cycle

Energy absorption: 26 % to 41 %

Dynamic force range: 295 lbs to 48,941 lbs

Operating temperature range: -40 °F to 194 °F

Construction size: 1.14 in to 7.40 in

Mounting: In any position

Material hardness rating: Shore 55D

Material: Profile body: Co-Polyester Elastomer

Environment: Resistant to microbes, seawater or chemical attack. Excellent UV and

ozone resistance. Material does not absorb water or swell.

Impact velocity range: Max. 16.4 ft/sec

Torque max.:

M5: 2.21 ft-lbs

M8: 14.75 ft-lbs

M16: 29.50 ft-lbs (DIN912)

M16: 88.51 ft-lbs (Shouldered screw)

Application field: Offshore industry, Agricultural machinery, Impact panels, Conveyor systems, Stacking units, Shipbuilding, Shovels or articulated joints for construction machinery, Transport roads, Loading and lifting equipment

Note: Suitable for emergency stop applications and for continuous use. For applications with preloading and increased temperatures please consult ACE.

Safety information: Mounting screw should additionally be secured with Loctite.

On request: Special strokes, -characteristics, -spring rates, -sizes and -materials.

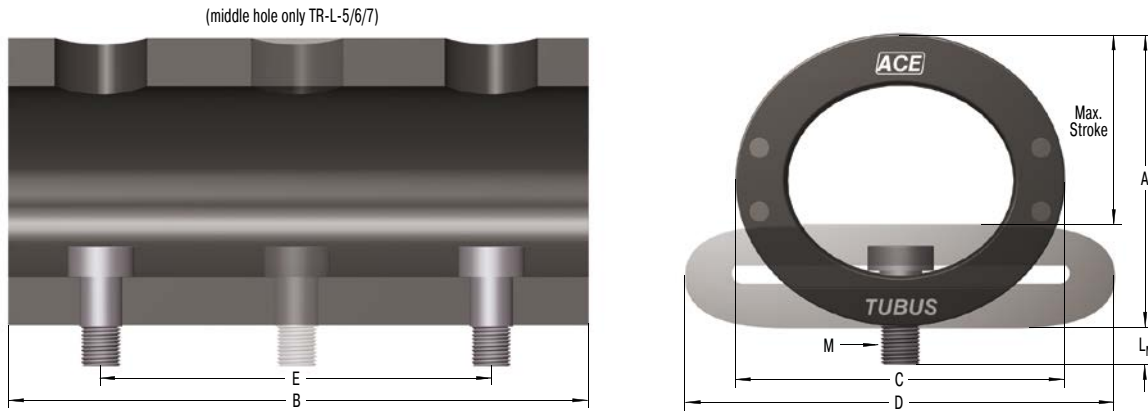
TR-L

The calculation and selection of the most suitable damper should be carried out or be approved by ACE.

Ordering Example

TUBUS Radial _____ **TR66-40L-2**
 Outer- \varnothing 2.60" (66 mm) _____
 Stroke 1.57" (40 mm) _____
 Long Version _____
 Length 2 = 12.01" (305 mm) _____

Performance and Dimensions

| TYPES | Emergency Stop | | Stroke max. inch | A inch | B inch | C inch | D inch | E inch | L _M inch | M | Weight lbs |
|--------------|---|--------------------------------|---------------------|-----------|-----------|-----------|-----------|-----------|------------------------|-----|---------------|
| | ¹ E ₃ in-lbs/cycle | E ₃ in-lbs/cycle | | | | | | | | | |
| TR29-17L | 63.7 | 96 | 0.67 | 0.98 | 3.15 | 1.14 | 1.50 | 1.57 | 0.20 | M5 | 0.064 |
| TR43-25L | 124 | 289 | 0.98 | 1.46 | 3.15 | 1.69 | 2.28 | 1.57 | 0.20 | M5 | 0.135 |
| TR63-43L | 194 | 283 | 1.69 | 2.17 | 3.15 | 2.48 | 3.43 | 1.57 | 0.20 | M5 | 0.223 |
| TR66-40L-1 | 903 | 1,266 | 1.57 | 2.32 | 5.98 | 2.60 | 3.43 | 4.02 | 0.31 | M8 | 0.627 |
| TR66-40L-2 | 1,806 | 2,531 | 1.57 | 2.32 | 12.01 | 2.60 | 3.43 | 10.00 | 0.31 | M8 | 1.279 |
| TR66-40L-3 | 2,708 | 3,788 | 1.57 | 2.32 | 17.99 | 2.60 | 3.43 | 15.98 | 0.31 | M8 | 1.784 |
| TR66-40L-4 | 3,611 | 5,054 | 1.57 | 2.32 | 24.02 | 2.60 | 3.43 | 22.01 | 0.31 | M8 | 2.347 |
| TR66-40L-5 | 4,514 | 6,319 | 1.57 | 2.32 | 30.00 | 2.60 | 3.43 | 27.99 | 0.31 | M8 | 2.963 |
| TR76-45L-1 | 1,283 | 1,797 | 1.77 | 2.68 | 5.98 | 2.99 | 3.94 | 4.02 | 0.31 | M8 | 0.838 |
| TR76-45L-2 | 2,567 | 3,593 | 1.77 | 2.68 | 12.01 | 2.99 | 3.94 | 10.00 | 0.31 | M8 | 1.535 |
| TR76-45L-3 | 3,850 | 5,390 | 1.77 | 2.68 | 17.99 | 2.99 | 3.94 | 15.98 | 0.31 | M8 | 2.492 |
| TR76-45L-4 | 5,133 | 7,187 | 1.77 | 2.68 | 24.02 | 2.99 | 3.94 | 22.01 | 0.31 | M8 | 3.153 |
| TR76-45L-5 | 6,417 | 8,984 | 1.77 | 2.68 | 30.00 | 2.99 | 3.94 | 27.99 | 0.31 | M8 | 4.013 |
| TR83-48L-1 | 1,593 | 2,230 | 1.89 | 2.87 | 5.98 | 3.27 | 4.17 | 4.02 | 0.31 | M8 | 1.058 |
| TR83-48L-2 | 3,186 | 4,461 | 1.89 | 2.87 | 12.01 | 3.27 | 4.17 | 10.00 | 0.31 | M8 | 1.917 |
| TR83-48L-3 | 4,779 | 6,691 | 1.89 | 2.87 | 17.99 | 3.27 | 4.17 | 15.98 | 0.31 | M8 | 3.043 |
| TR83-48L-4 | 6,373 | 8,922 | 1.89 | 2.87 | 24.02 | 3.27 | 4.17 | 22.01 | 0.31 | M8 | 3.991 |
| TR83-48L-5 | 7,966 | 11,152 | 1.89 | 2.87 | 30.00 | 3.27 | 4.17 | 27.99 | 0.31 | M8 | 4.983 |
| TR99-60L-1 | 2,390 | 3,346 | 2.36 | 3.46 | 5.98 | 3.90 | 5.12 | 4.02 | 0.31 | M8 | 1.299 |
| TR99-60L-2 | 4,779 | 6,691 | 2.36 | 3.46 | 12.01 | 3.90 | 5.12 | 10.00 | 0.31 | M8 | 2.567 |
| TR99-60L-3 | 7,169 | 10,037 | 2.36 | 3.46 | 17.99 | 3.90 | 5.12 | 15.98 | 0.31 | M8 | 4.278 |
| TR99-60L-4 | 9,559 | 13,382 | 2.36 | 3.46 | 24.02 | 3.90 | 5.12 | 22.01 | 0.31 | M8 | 5.865 |
| TR99-60L-5 | 11,949 | 16,728 | 2.36 | 3.46 | 30.00 | 3.90 | 5.12 | 27.99 | 0.31 | M8 | 6.836 |
| TR99-60L-6 | 14,338 | 20,073 | 2.36 | 3.46 | 35.98 | 3.90 | 5.12 | 34.02 | 0.31 | M8 | 8.255 |
| TR99-60L-7 | 16,728 | 23,419 | 2.36 | 3.46 | 42.01 | 3.90 | 5.12 | 40.00 | 0.31 | M8 | 9.482 |
| TR143-86L-1 | 5,310 | 7,435 | 3.39 | 5.00 | 5.98 | 5.63 | 7.52 | 2.99 | 0.87 | M16 | 3.462 |
| TR143-86L-2 | 10,621 | 14,869 | 3.39 | 5.00 | 12.01 | 5.63 | 7.52 | 7.99 | 0.87 | M16 | 6.262 |
| TR143-86L-3 | 15,931 | 22,304 | 3.39 | 5.00 | 17.99 | 5.63 | 7.52 | 13.98 | 0.87 | M16 | 8.555 |
| TR143-86L-4 | 21,242 | 29,738 | 3.39 | 5.00 | 24.02 | 5.63 | 7.52 | 20.00 | 0.87 | M16 | 11.951 |
| TR143-86L-5 | 26,552 | 37,173 | 3.39 | 5.00 | 30.00 | 5.63 | 7.52 | 25.98 | 0.87 | M16 | 15.589 |
| TR143-86L-6 | 31,863 | 44,608 | 3.39 | 5.00 | 35.98 | 5.63 | 7.52 | 31.97 | 0.87 | M16 | 18.456 |
| TR143-86L-7 | 37,173 | 52,042 | 3.39 | 5.00 | 42.01 | 5.63 | 7.52 | 37.99 | 0.87 | M16 | 20.903 |
| TR188-108L-1 | 9,736 | 13,630 | 4.25 | 6.50 | 5.98 | 7.40 | 9.65 | 2.99 | 1.02 | M16 | 5.465 |
| TR188-108L-2 | 19,472 | 27,260 | 4.25 | 6.50 | 12.01 | 7.40 | 9.65 | 7.99 | 1.02 | M16 | 8.897 |
| TR188-108L-3 | 29,207 | 40,890 | 4.25 | 6.50 | 17.99 | 7.40 | 9.65 | 13.98 | 1.02 | M16 | 15.898 |
| TR188-108L-4 | 38,943 | 54,521 | 4.25 | 6.50 | 24.02 | 7.40 | 9.65 | 20.00 | 1.02 | M16 | 21.653 |
| TR188-108L-5 | 48,679 | 68,151 | 4.25 | 6.50 | 30.00 | 7.40 | 9.65 | 25.98 | 1.02 | M16 | 25.115 |
| TR188-108L-6 | 58,415 | 81,781 | 4.25 | 6.50 | 35.98 | 7.40 | 9.65 | 31.97 | 1.02 | M16 | 30.716 |
| TR188-108L-7 | 68,151 | 95,411 | 4.25 | 6.50 | 42.01 | 7.40 | 9.65 | 37.99 | 1.02 | M16 | 35.148 |

¹ Max. energy capacity per cycle for continuous use.

TUBUS TR-HD

Compact powerhouse in solid material

Radial Damping, Heavy Duty Version

Energy capacity 3,585 in-lbs/Cycle to 104,793 in-lbs/Cycle

Maximum stroke 0.47 in to 1.73 in

Impact and collision protection: The TR-HD profile dampers are stressed in the same way as the basic model TR but offer a higher force and energy absorption with a shorter damping distance thanks to the solid design. Different damping characteristic curves can be achieved with two different co-polyester elastomer hardness levels. The slightly oval (bi-concave) shape also ensures a softer force intake.

This product family absorbs a lot of energy despite the low height: a range of 3,585 in-lbs to 104,793 in-lbs (405 Nm to 11,840 Nm) is progressively covered by strokes of 0.47" to 1.73" (12 mm to 44 mm). Delivered with two included screws, the damper can be easily and quickly installed both horizontally or vertically. The drill hole distance can be adapted if required.

These dampers are used in agricultural technology and on shovels or break joints on construction machines as well as on loading and lifting or similar equipment.



Technical Data

Energy capacity: 3,585 in-lbs/Cycle to 104,793 in-lbs/Cycle

Energy absorption: 43 % to 72 %

Dynamic force range: 17,715 lbs to 182,748 lbs

Operating temperature range: -40 °F to 194 °F

Construction size: 1.65 in to 46.29 in

Mounting: In any position

Material hardness rating: Shore 40D, Shore 55D

Material: Profile body: Co-Polyester Elastomer

Environment: Resistant to microbes, seawater or chemical attack. Excellent UV and ozone resistance. Material does not absorb water or swell.

Impact velocity range: Max. 16.4 ft/sec

Torque max.:

M10: 5.16 ft-lbs

M12: 8.85 ft-lbs

Application field: Offshore industry, Agricultural machinery, Impact panels, Conveyor systems, Stacking units, Shipbuilding, Shovels or articulated joints for construction machinery, Transport roads, Loading and lifting equipment

Note: Suitable for emergency stop applications and for continuous use. For applications with preloading and increased temperatures please consult ACE.

Safety information: Mounting screw should additionally be secured with Loctite.

On request: Special strokes, -characteristics, -spring rates, -sizes and -materials.

TR-HD

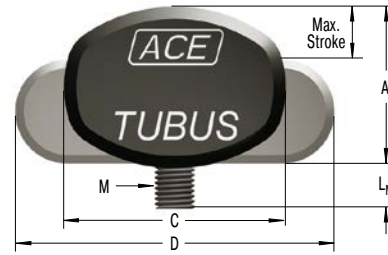
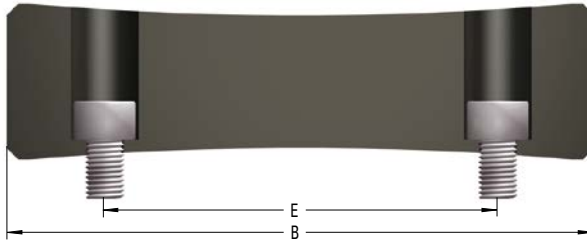

Characteristics

TUBUS TR-HD

Force-Stroke Characteristics (static)

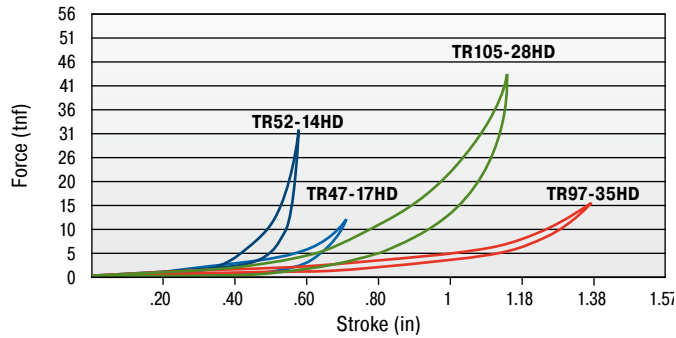

The calculation and selection of the most suitable damper should be carried out or be approved by ACE.

Ordering Example

TUBUS Radial _____
 Outer- \varnothing 2.48" (63 mm) _____
 Stroke 0.94" (24 mm) _____
 Heavy Duty Version _____

TR63-24HD

Performance and Dimensions

| TYPES | Emergency Stop | | F max. static lbs | Stroke max. inch | A inch | B inch | C inch | D inch | E inch | L _M inch | M | Weight lbs |
|------------|---|--------------------------------|----------------------|---------------------|-----------|-----------|-----------|-----------|-----------|------------------------|-----|---------------|
| | ¹ E ₃ in-lbs/cycle | E ₃ in-lbs/cycle | | | | | | | | | | |
| TR42-14HD | 3,585 | 5,018 | 14,365 | 0.58 | 1.33 | 5.84 | 1.65 | 2.31 | 4.02 | 0.79 | M10 | 0.472 |
| TR47-12HD | 7,585 | 10,621 | 33,632 | 0.48 | 1.23 | 5.92 | 1.83 | 2.28 | 4.02 | 0.75 | M10 | 0.494 |
| TR47-17HD | 7,523 | 10,532 | 27,449 | 0.67 | 1.27 | 5.90 | 1.84 | 2.75 | 4.02 | 0.94 | M10 | 0.494 |
| TR52-14HD | 14,462 | 20,250 | 68,455 | 0.47 | 1.07 | 6.10 | 2.14 | 2.73 | 4.02 | 0.87 | M10 | 0.494 |
| TR57-21HD | 10,568 | 14,798 | 23,560 | 0.86 | 1.87 | 5.86 | 2.23 | 3.12 | 4.02 | 0.71 | M10 | 0.847 |
| TR62-15HD | 15,843 | 22,180 | 55,078 | 0.62 | 1.59 | 6.02 | 2.44 | 3.04 | 4.02 | 0.63 | M10 | 0.825 |
| TR62-19HD | 26,021 | 36,430 | 87,653 | 0.66 | 1.50 | 6.25 | 2.94 | 3.71 | 4.02 | 0.63 | M10 | 0.706 |
| TR63-24HD | 18,241 | 25,534 | 43,703 | 0.97 | 1.79 | 6.02 | 2.46 | 3.61 | 4.02 | 0.79 | M10 | 0.831 |
| TR72-26HD | 15,046 | 21,065 | 28,056 | 1.04 | 2.33 | 5.88 | 2.84 | 3.86 | 4.02 | 0.91 | M12 | 1.235 |
| TR79-20HD | 24,729 | 34,624 | 65,038 | 0.82 | 2.11 | 6.04 | 3.12 | 3.86 | 4.02 | 0.94 | M12 | 1.411 |
| TR79-31HD | 26,331 | 36,863 | 50,942 | 1.17 | 2.21 | 6.09 | 3.10 | 4.42 | 4.02 | 0.91 | M12 | 1.169 |
| TR85-33HD | 22,357 | 31,296 | 32,845 | 1.26 | 2.75 | 5.89 | 3.20 | 4.36 | 4.02 | 0.91 | M12 | 1.566 |
| TR89-21HD | 39,280 | 54,990 | 107,324 | 0.85 | 1.88 | 6.37 | 3.50 | 4.42 | 4.02 | 0.87 | M12 | 1.389 |
| TR90-37HD | 33,456 | 46,838 | 54,112 | 1.48 | 2.71 | 6.11 | 3.56 | 5.04 | 4.02 | 0.91 | M12 | 1.808 |
| TR93-24HD | 30,278 | 42,386 | 68,005 | 0.96 | 2.50 | 6.10 | 3.66 | 4.54 | 4.02 | 0.91 | M12 | 1.742 |
| TR97-31HD | 68,487 | 95,880 | 129,311 | 1.00 | 2.23 | 6.45 | 4.11 | 5.07 | 4.02 | 0.83 | M12 | 1.918 |
| TR97-35HD | 24,968 | 34,952 | 34,351 | 1.50 | 3.30 | 5.93 | 3.85 | 5.16 | 4.02 | 0.79 | M12 | 2.337 |
| TR102-44HD | 41,572 | 58,202 | 57,214 | 1.74 | 3.18 | 6.15 | 4.10 | 5.80 | 4.02 | 0.87 | M12 | 2.315 |
| TR105-28HD | 49,927 | 69,894 | 96,129 | 1.02 | 2.74 | 6.14 | 4.12 | 4.97 | 4.02 | 0.83 | M12 | 2.205 |
| TR117-30HD | 74,851 | 104,793 | 143,676 | 1.09 | 2.48 | 6.57 | 4.59 | 5.61 | 4.02 | 0.98 | M12 | 2.381 |

¹ Max. energy capacity per cycle for continuous use.

Application Examples

TUBUS TA

Safe end position damping

ACE TUBUS profile dampers protect the integrated loading station on a new high speed machining center. The ACE TUBUS damper is designed to prevent overrun on the high speed loading station of a Camshaft machining centre used in the automobile industry. In the event that the drive train fails during operation or incorrect data is inputted the ACE TUBUS damper absorbs the impact preventing costly damage to the machine. The TA98-40 TUBUS damper impressed engineers with this exceptionally long service life in operation. When used as an emergency stop the TUBUS damper can absorb up to 73 % of the impact energy.



Safety with ultra high speed operation

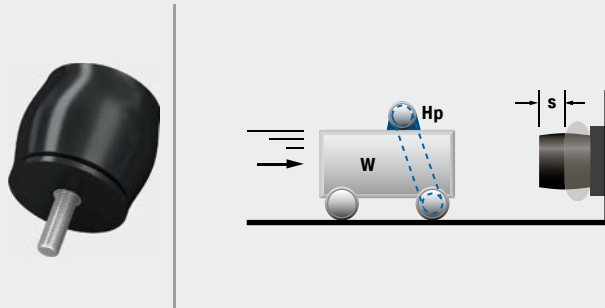

TUBUS TS

Safe braking of maintenance boats

The maintenance of wind turbines in open seas has long resulted in damage to maintenance boats. Because of impact velocity and swell, an increase in the boat's mass of up to 20 percent must be taken into account when landing on a rigid mooring structure. It is only since the landing operation has been carried out with the aid of the ACE company's TUBUS series that cable repair and maintenance work on wind turbines has been made safe for both personnel and equipment. TUBUS of the type TS84-43 are seawater resistant and can withstand ambient temperatures from -40 °F to + 194 °F.



Seawater-resistant, robust TUBUS profile dampers made of co-polyester elastomer allow boats and crew to dock safely
Wals Diving and Marine Service, 1970AC IJmuiden, Netherlands

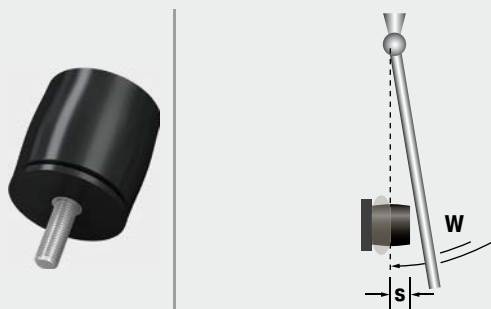

TUBUS TS

Protection of drive used in space treadmill

When training in zero gravity, a harness with bungee cords is used to ensure that trainees do not become disengaged. Three ACE profile dampers with a linear-working facility are utilized in this case. One TUBUS is positioned in the pneumatic cylinder, while the other two are put in place in the rest of the system. All the dampers have the task of protecting the system if the treadmill drive belts become damaged. Otherwise, the cylinder would reach a very high speed and become seriously damaged at the end of the stroke.



TUBUS are used to protect a fitness machine in zero gravity
QinetiQ Space nv, 9150 Kruibekke, Belgium

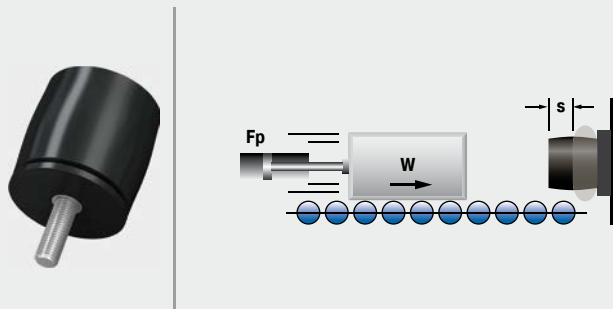

TUBUS TR

Gentle damping for electric scooters

TUBUS bumpers make driving an e-scooter a real experience. The footboard of an electric scooter should be dampened to enable the driver to experience a comfortable ride even over potholes and other bumpy surfaces. Ideally, the characteristic line should be furnished with a soft increase in force over a long stroke. The elegant look of the scooter as well as the folding mechanism designed to save space have not allowed the use of feasible damper solutions until now. Inferior alternatives such as rubber dampers made of polyurethane or simple steel springs could not be considered from the start. The TUBUS bumper TR52-32H offered the perfect solution with its compact construction design paired with progressive damping action.



Profile dampers increase the riding comfort of an electric scooter

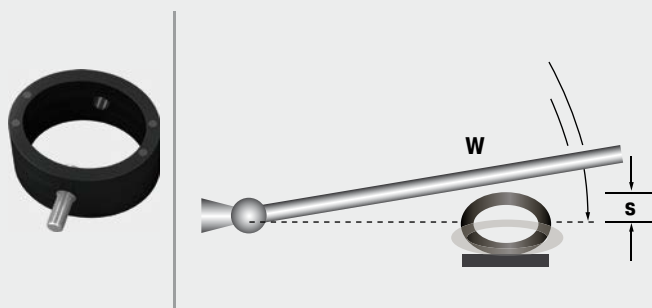

Special Profile Dampers

Cost-effective damping for your pressing tools

ACE provides TUBUS profile dampers in many variations. Special solutions for presses can now be cost-effectively achieved with down holder dampers, damping plugs, lift dampers and press dampers from ACE.

They replace the PU-springs previously used in the automotive industry. It was no longer possible for them to fulfil the required tasks due to the higher return stroke speeds in modern pressing tools. Made of co-polyester elastomers, the TUBUS special takes care of the protection of mounting bolts and insert bolts much more reliably. On the one hand they protect a so-called down holders during the return stroke after the forming of sheet metal parts, and on the other they function as protection for hoisting lifters.

High reliability

Long service life

High power and energy absorption

Efficient working through higher cycle rates

Extreme abrasion hardness and sheer strength

Noise reduction



TUBUS Special Profile Dampers

A wide range of solutions for your tools

Small but effective: These versatile, custom-manufactured components make all the difference during sheet metal forming in the automotive and tool industries thanks to long service lives and high power absorption.



TUBUS Down Holder Dampers

The innovation as a substitute for overburdened PU springs

The axial-functioning elements are ideal for different diameters of mounting bolts from M10 to M30 in the press tools. They increase clock rates, service lives and reliability during increased cushioning strokes there.



TUBUS Lift Dampers

The brother of the down holder damper

Used in the end position damping in ProgDie presses, they sit on the mounting bolts of the spring-loaded belt guide rails or hoisting lifters in the bottom part of the tool of the follow-on composite tool, protect it and accelerate production.



TUBUS Damping Plugs

A special kind of emergency plug

These side-mounted, radial damping elements also protect the mounting bolts and insert bolts during the opening of the pressing tools. They are available in four different sizes and are used in large tools.



TUBUS Press Dampers

When a side effect (nearly) becomes the main thing

All TUBUS specials additionally reduce noise. In press dampers, used particularly in eccentric presses by manufacturers of large household appliances, this is however the main task. Screwed into a hole pocket, they also effectively protect the tools.

Damping Pads

Customized damping technology

With damping pads from the SLAB series, ACE provides solutions to effectively slow down loads impacting large and small surfaces. This means that these products are found in a wide range of damping technologies from ACE where oscillation begins or where damaging impacts in construction designs need to be slowed over a large surface.

The ACE SLAB pads, available to choose in any size, absorb static loads from 0.26 to 2.65 in-lb² and can be either cut to size according to each requirement or designed as a molded part. Simply use an adhesive to install. The standard plate heights are between 0.5 and 1 inch. Many different coatings clear the way for numerous applications and not least because they can be used in a temperature range from 23 °F to 122 °F.

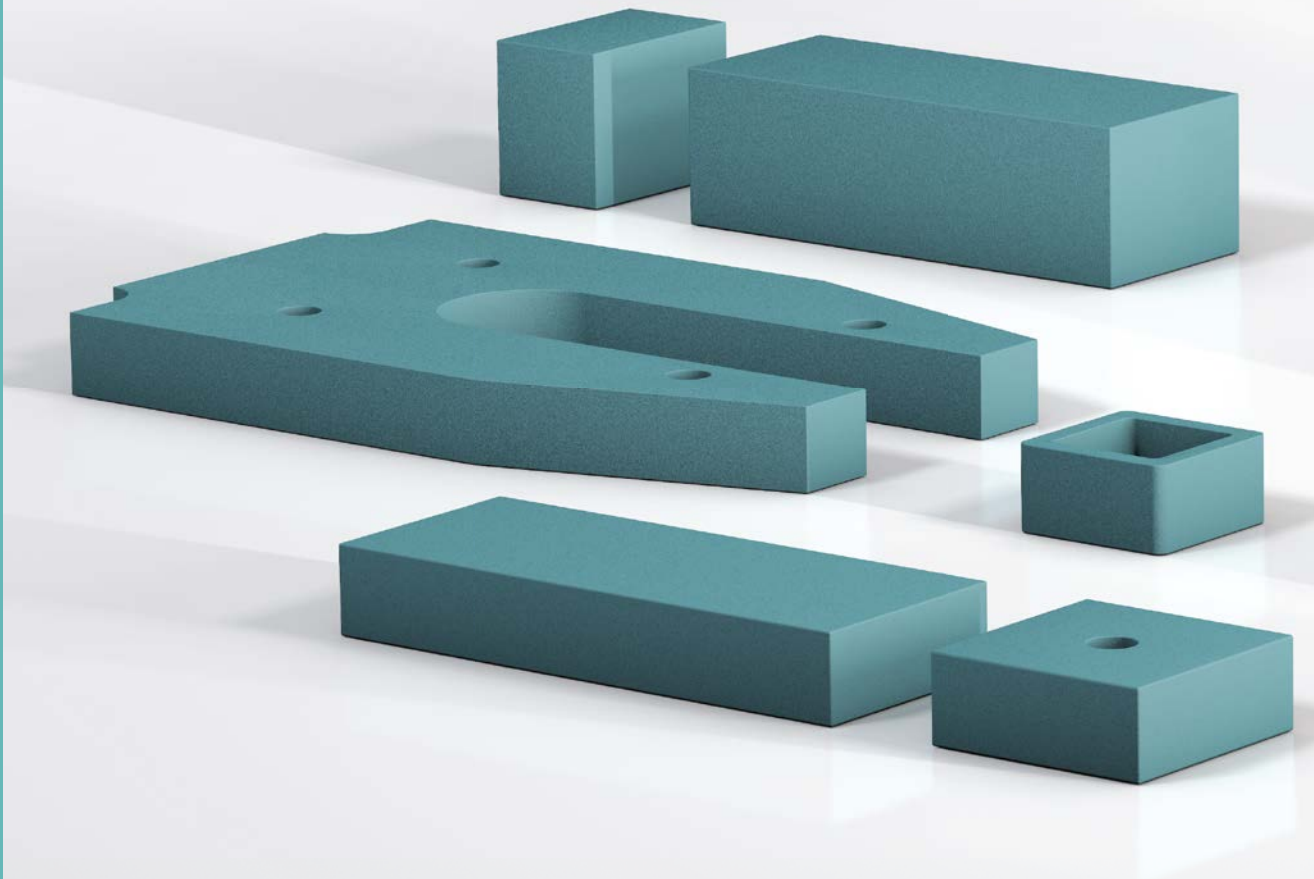

Individual Pad Cutting

SLAB pads pre-assembled for each project

Whether pads, cuts or drawing parts, stocked SLAB pads in combination with our freely programmable cutting machine ensure maximum flexibility with excellent delivery speed.

Fast, flexible and adapted to your conditions.

Ask for special solutions!!!

Can be integrated quickly and cost-effectively

Immense inner damping

Pad thicknesses up to 3.15 inch on request

Can be assembled with CNC cutting machines

Patented formula

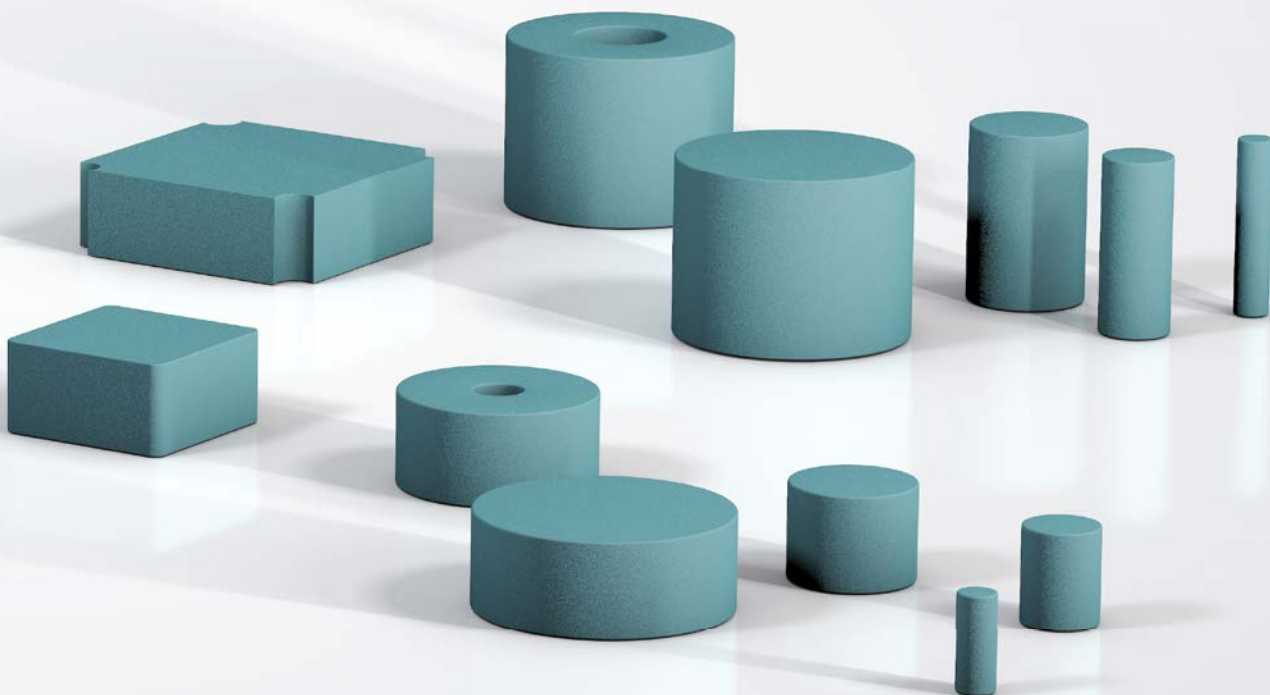

SLAB 030 to SLAB 300

Energy absorption in pad format

Connectable and Combinable

Energy capacity 27.4 in-lbs/Cycle to 1,858.7 in-lbs/Cycle

Stroke 0.26 inch to 0.49 inch

Tailor made damping material in pad format: SLAB damping pads are made of a viscoelastic PUR-material. They absorb impact loads extremely effectively and are also suitable for insulating or damping vibration.

The pads of the product family SL-030 to SL-300 are quickly adapted to the relevant type of application. This is in part achieved through the configuration of the calculating tool or directly by the ACE specialist engineers. Furthermore, this is possible because the standard material can be cut exactly and quickly to any customer requirement with our new cutting system. It is also possible to obtain a sample to find an optimum solution.

The SLAB damping pads are proven impact or collision protection. They are used on luggage and transport belts, conveyor systems, pneumatic, electromechanical and hydraulic drives as well as on linear carriages.

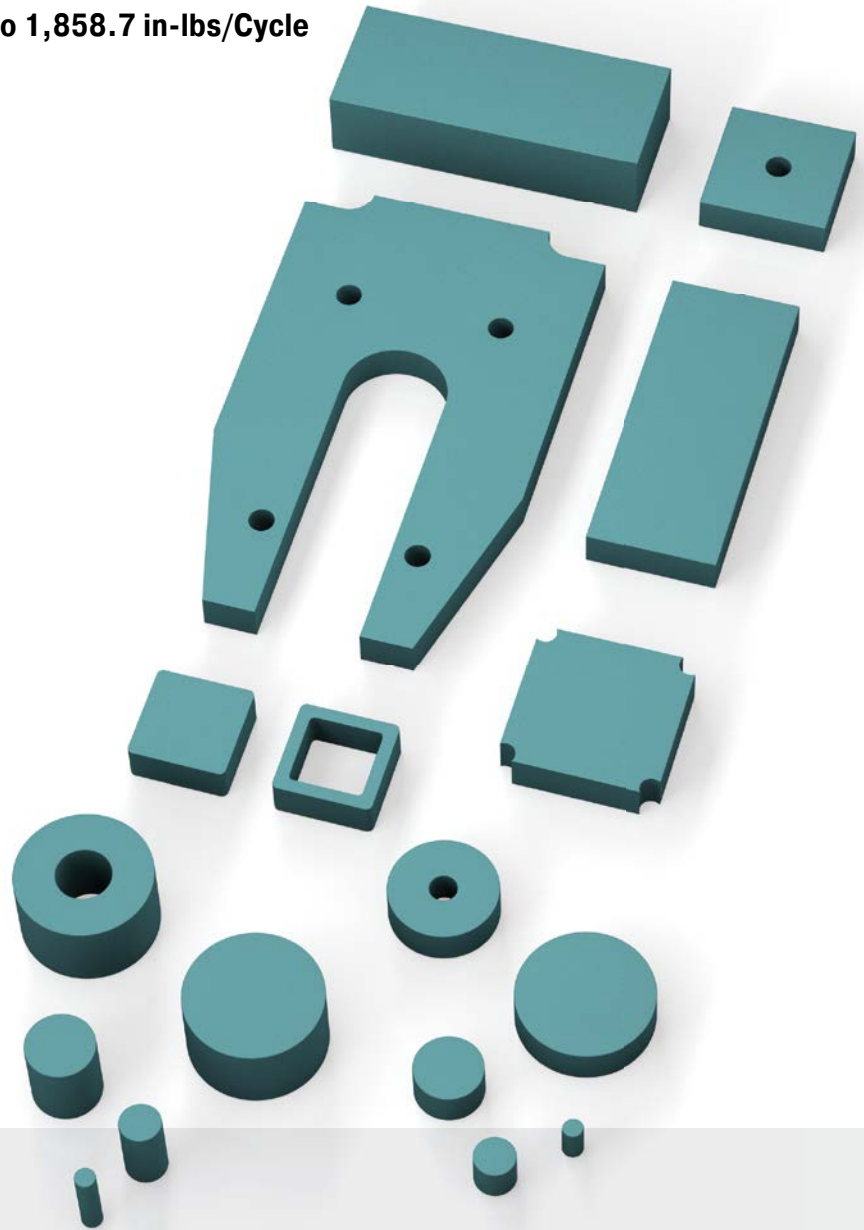

Technical Data

Energy capacity: 27.4 in-lbs/Cycle to 1,858.7 in-lbs/Cycle

Standard density:

SL-030 = approx. 12.48 lbs/ft³

SL-100 = approx. 27.47 lbs/ft³

SL-300 = approx. 42.45 lbs/ft³

Standard colour: Green

Dimensions:

Widths: up to 59 inch

Lengths: up to 197 inch

Thicknesses: 0.5 inch and 1 inch

Environment: Resistant against ozone and UV radiation. Chemical resistancy on request.

Operating temperature range: 23 °F to 122 °F

Material: Profile body: Mixed cellular PUR-Elastomer (polyurethane)

Application field: Linear slides, Handling modules, Luggage and transport belts, Impact panels, Pipeline insulation, Foundation mounting, Conveyor technology, Electronic systems and controls, Medical technology, Buildings

Note: Possibilities for cutting: Water jet cutting, stamping, splitting, sawing and drilling

Safety information: Fire rating: B2, normally flammable, according to DIN 4102

On request: Special versions with further dimensions such as thicknesses, colours, shapes and drawing parts e.g. curves. Different wear layers.

SL-030-12

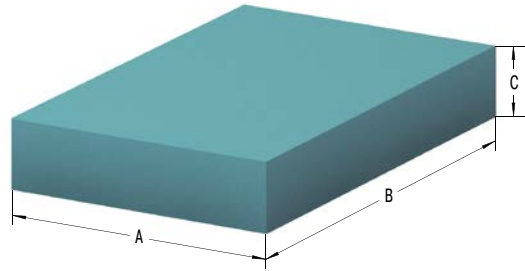

Characteristics

Type SL-030-12
Force-Stroke Characteristic (dynamic)
Stroke Utilization 0.26 in

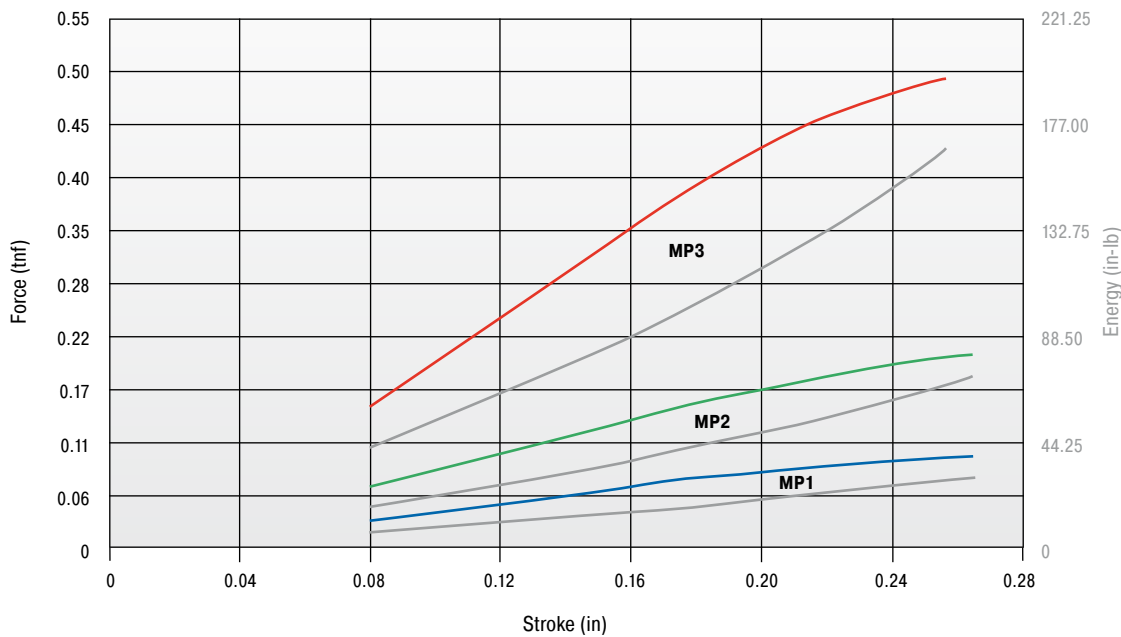

Load data

Dynamic load, impact velocity: approx. 3.28 ft/s

| | | |
|-----------|------|------------------------|
| — (Red) | Area | 15,500 in ² |
| — (Green) | Area | 7,750 in ² |
| — (Blue) | Area | 3,875 in ² |

tnf = ton force

The chosen damping plate should be tested by the customer on the specific application.

Ordering Example

ACE-SLAB _____ **SL-030-12-Dxxxx**
 Material Type _____
 Material Thickness 0.49" (12.5 mm) _____
 Customers Specific Dimension/Shape _____
 (D-Number is assigned by ACE)

Performance and Dimensions

| TYPES | ¹ E ₃ max. in-lbs/cycle | ¹ Stroke inch | A inch | B inch | C inch | Area inch ² | Standard density lbs/ft ³ | Return Time s | Weight lbs |
|-----------------|--|-----------------------------|-----------|-----------|-----------|---------------------------|---|------------------|---------------|
| SL-030-12-D-MP1 | 27.44 | 0.26 | 1.97 | 1.97 | 0.49 | 3.875 | 12.48 | 4 | 0.014 |
| SL-030-12-D-MP2 | 70.81 | 0.26 | 2.78 | 2.78 | 0.49 | 7.750 | 12.48 | 4 | 0.028 |
| SL-030-12-D-MP3 | 168.16 | 0.26 | 3.94 | 3.94 | 0.49 | 15.500 | 12.48 | 4 | 0.055 |

¹ Maximum energy absorption in terms of area graded pad sizes as a reference for the correct selection of material and pad size. The energy absorption depends on the individual impact surface and stroke utilization.

Connectable and Combinable

SL-030-25

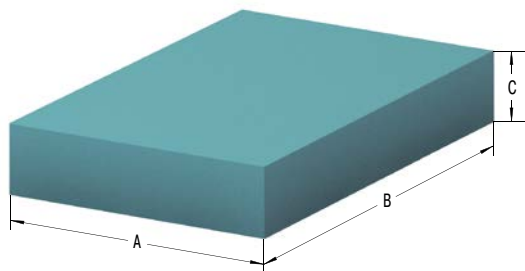

Characteristics

Type SL-030-25
 Force-Stroke Characteristic (dynamic)
 Stroke Utilization 0.49 in

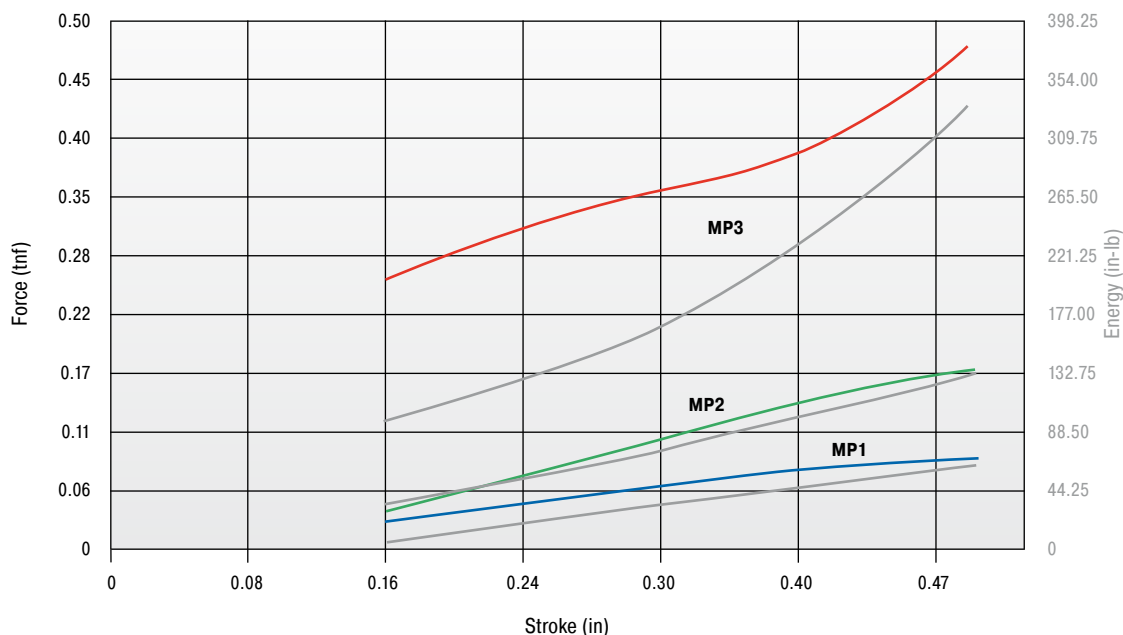

Load data
 Dynamic load, impact velocity: approx. 3.28 ft/s

| | |
|----------------|-----------------------------|
| — (Red line) | Area 15,500 in ² |
| — (Green line) | Area 7,750 in ² |
| — (Blue line) | Area 3,875 in ² |

tnf = ton force

The chosen damping plate should be tested by the customer on the specific application.

Ordering Example

SL-030-25-Dxxxx
 ACE-SLAB _____
 Material Type _____
 Material Thickness 0.98" (25 mm) _____
 Customers Specific Dimension/Shape _____
 (D-Number is assigned by ACE)

Performance and Dimensions

| TYPES | ¹ E ₃ max. in-lbs/cycle | ¹ Stroke inch | A inch | B inch | C inch | Area inch ² | Standard density lbs/ft ³ | Return Time s | Weight lbs |
|-----------------|--|-----------------------------|-----------|-----------|-----------|---------------------------|---|------------------|---------------|
| SL-030-25-D-MP1 | 59.30 | 0.49 | 1.97 | 1.97 | 0.98 | 3.875 | 12.48 | 5 | 0.028 |
| SL-030-25-D-MP2 | 132.76 | 0.49 | 2.78 | 2.78 | 0.98 | 7.750 | 12.48 | 5 | 0.055 |
| SL-030-25-D-MP3 | 371.73 | 0.49 | 3.94 | 3.94 | 0.98 | 15.500 | 12.48 | 5 | 0.110 |

¹ Maximum energy absorption in terms of area graded pad sizes as a reference for the correct selection of material and pad size. The energy absorption depends on the individual impact surface and stroke utilization.

SL-100-12

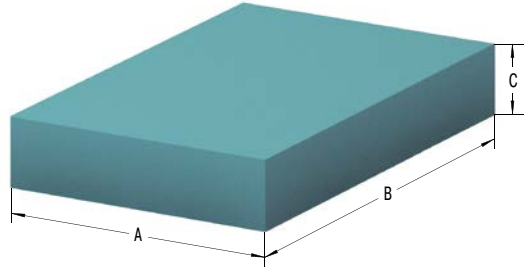

Characteristics

Type SL-100-12
Force-Stroke Characteristic (dynamic)
Stroke Utilization 0.26 in

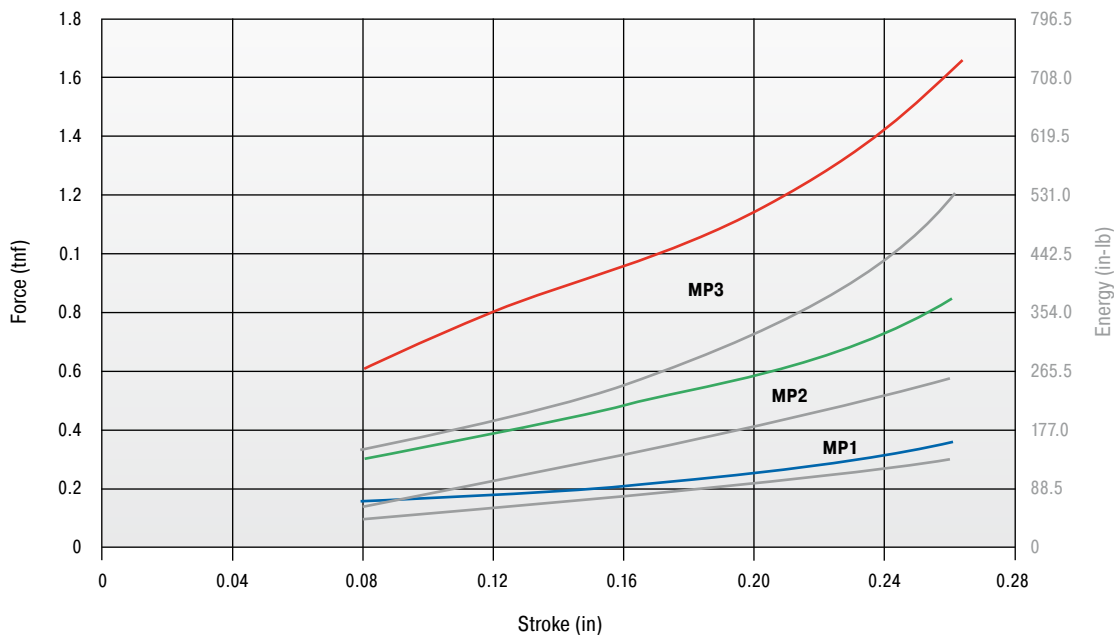

Load data
 Dynamic load, impact velocity: approx. 3.28 ft/s

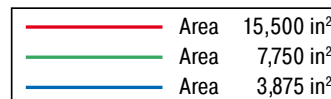

tnf = ton force

The chosen damping plate should be tested by the customer on the specific application.

Ordering Example

ACE-SLAB _____ **SL-100-12-Dxxxx**
 Material Type _____
 Material Thickness 0.49" (12.5 mm) _____
 Customers Specific Dimension/Shape _____
 (D-Number is assigned by ACE)

Performance and Dimensions

| TYPES | ¹ E ₃ max. in-lbs/cycle | ¹ Stroke inch | A inch | B inch | C inch | Area inch ² | Standard density lbs/ft ³ | Return Time s | Weight lbs |
|-----------------|--|-----------------------------|-----------|-----------|-----------|---------------------------|---|------------------|---------------|
| SL-100-12-D-MP1 | 132.76 | 0.26 | 1.97 | 1.97 | 0.49 | 3.875 | 27.47 | 4 | 0.030 |
| SL-100-12-D-MP2 | 265.52 | 0.26 | 2.78 | 2.78 | 0.49 | 7.750 | 27.47 | 4 | 0.061 |
| SL-100-12-D-MP3 | 531.04 | 0.26 | 3.94 | 3.94 | 0.49 | 15.500 | 27.47 | 4 | 0.121 |

¹ Maximum energy absorption in terms of area graded pad sizes as a reference for the correct selection of material and pad size. The energy absorption depends on the individual impact surface and stroke utilization.

Connectable and Combinable

SL-100-25

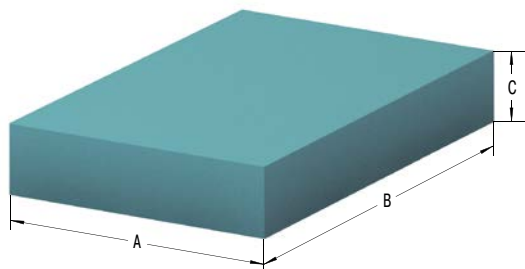

Characteristics

Type SL-100-25
 Force-Stroke Characteristic (dynamic)
 Stroke Utilization 0.49 in

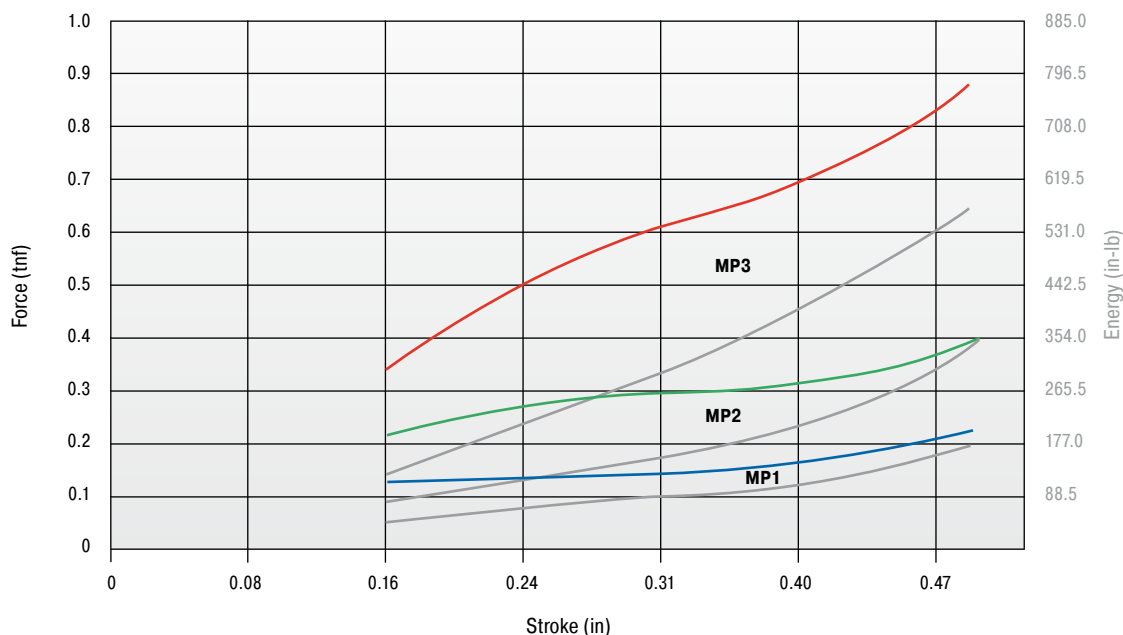

Load data
 Dynamic load, impact velocity: approx. 3.28 ft/s

| | |
|-----------|-----------------------------|
| — (Red) | Area 15,500 in ² |
| — (Green) | Area 7,750 in ² |
| — (Blue) | Area 3,875 in ² |

tnf = ton force

The chosen damping plate should be tested by the customer on the specific application.

Ordering Example

ACE-SLAB _____
 Material Type _____
 Material Thickness 0.98" (25 mm) _____
 Customers Specific Dimension/Shape _____
 (D-Number is assigned by ACE)

SL-100-25-Dxxxx

Performance and Dimensions

| TYPES | ¹ E ₃ max. in-lbs/cycle | ¹ Stroke inch | A inch | B inch | C inch | Area inch ² | Standard density lbs/ft ³ | Return Time s | Weight lbs |
|-----------------|--|-----------------------------|-----------|-----------|-----------|---------------------------|---|------------------|---------------|
| SL-100-25-D-MP1 | 177.01 | 0.49 | 1.97 | 1.97 | 0.98 | 3.875 | 27.47 | 5 | 0.061 |
| SL-100-25-D-MP2 | 354.03 | 0.49 | 2.78 | 2.78 | 0.98 | 7.750 | 27.47 | 5 | 0.121 |
| SL-100-25-D-MP3 | 557.60 | 0.49 | 3.94 | 3.94 | 0.98 | 15.500 | 27.47 | 5 | 0.243 |

¹ Maximum energy absorption in terms of area graded pad sizes as a reference for the correct selection of material and pad size. The energy absorption depends on the individual impact surface and stroke utilization.

SL-300-12

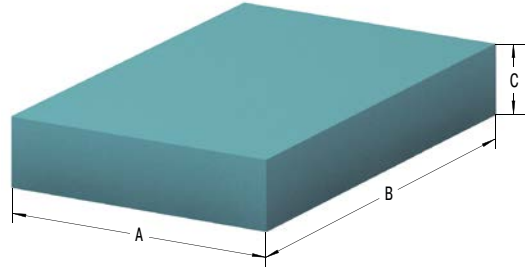

Characteristics

Type SL-300-12
Force-Stroke Characteristic (dynamic)
Stroke Utilization 0.26 in

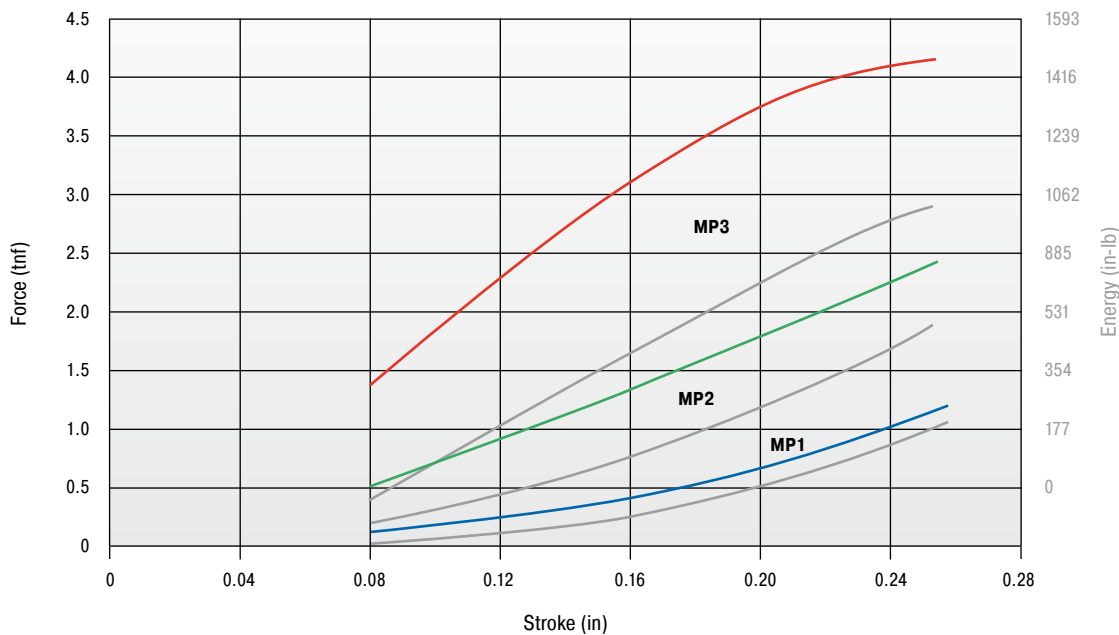

Load data

Dynamic load, impact velocity: approx. 3.28 ft/s



tnf = ton force

The chosen damping plate should be tested by the customer on the specific application.

Ordering Example

ACE-SLAB _____ **SL-300-12-Dxxxx**
 Material Type _____
 Material Thickness 0.49" (12.5 mm) _____
 Customers Specific Dimension/Shape _____
 (D-Number is assigned by ACE)

Performance and Dimensions

| TYPES | ¹ E ₃ max. in-lbs/cycle | ¹ Stroke inch | A inch | B inch | C inch | Area inch ² | Standard density lbs/ft ³ | Return Time s | Weight lbs |
|-----------------|--|-----------------------------|-----------|-----------|-----------|---------------------------|---|------------------|---------------|
| SL-300-12-D-MP1 | 336.33 | 0.26 | 1.97 | 1.97 | 0.49 | 3.875 | 42.45 | 3 | 0.046 |
| SL-300-12-D-MP2 | 575.30 | 0.26 | 2.78 | 2.78 | 0.49 | 7.750 | 42.45 | 3 | 0.094 |
| SL-300-12-D-MP3 | 1,070.94 | 0.26 | 3.94 | 3.94 | 0.49 | 15.500 | 42.45 | 3 | 0.187 |

¹ Maximum energy absorption in terms of area graded pad sizes as a reference for the correct selection of material and pad size. The energy absorption depends on the individual impact surface and stroke utilization.

Connectable and Combinable

SL-300-25

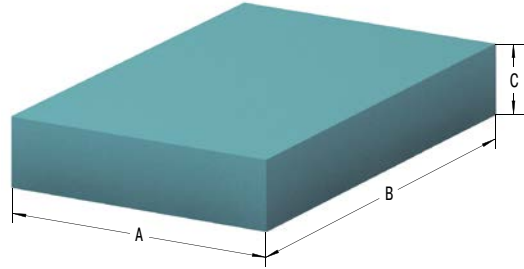

Characteristics

Type SL-300-25
Force-Stroke Characteristic (dynamic)
Stroke Utilization 0.49 in

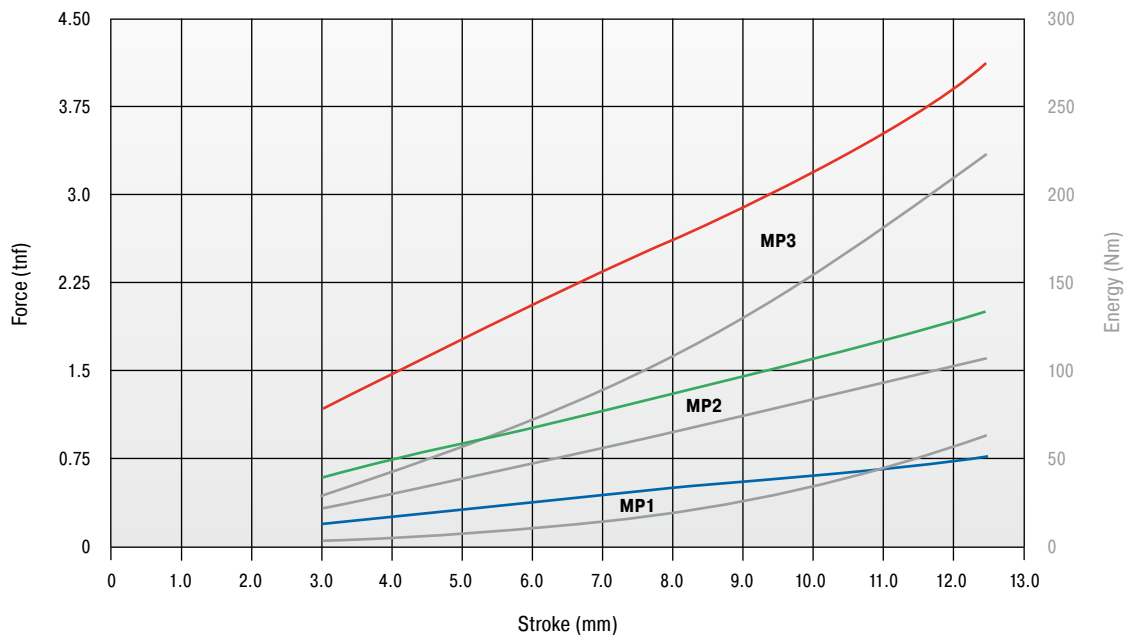

Load data
 Dynamic load, impact velocity: approx. 3.28 ft/s

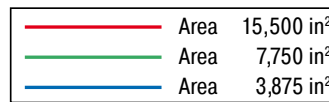

tnf = ton force

The chosen damping plate should be tested by the customer on the specific application.

Ordering Example

ACE-SLAB _____ **SL-300-25-Dxxxx**
 Material Type _____
 Material Thickness 0.98" (25 mm) _____
 Customers Specific Dimension/Shape _____
 (D-Number is assigned by ACE)

Performance and Dimensions

| TYPES | ¹ E ₃ max. in-lbs/cycle | ¹ Stroke inch | A inch | B inch | C inch | Area inch ² | Standard density lbs/ft ³ | Return Time s | Weight lbs |
|-----------------|--|-----------------------------|-----------|-----------|-----------|---------------------------|---|------------------|---------------|
| SL-300-25-D-MP1 | 522.19 | 0.49 | 1.97 | 1.97 | 0.98 | 3.875 | 42.45 | 4 | 0.094 |
| SL-300-25-D-MP2 | 893.92 | 0.49 | 2.78 | 2.78 | 0.98 | 7.750 | 42.45 | 4 | 0.187 |
| SL-300-25-D-MP3 | 1,858.66 | 0.49 | 3.94 | 3.94 | 0.98 | 15.500 | 42.45 | 4 | 0.375 |

¹ Maximum energy absorption in terms of area graded pad sizes as a reference for the correct selection of material and pad size. The energy absorption depends on the individual impact surface and stroke utilization.

Bonding of Polyurethane (PUR) Elastomers

Cellular and compact parts of polyurethane (PUR) elastomers SLAB damping pads can be bonded according to the following recommendations. If treatment instructions are followed, the strengths of the bonded joint can be equivalent to the elastomer material itself.

1. General Information

To achieve the required bonding strength it is necessary to ensure the correct adhesive is chosen for each individual application.

Contact bonding material

Thin adhesive film, with little filling of the gaps. Correcting or moving of the areas covered with bonding material is no longer possible after the first contact is made (contact effect).

Once a bonding is separated, the bonding process must be renewed.

Please note that creases, ripples or blisters cannot be straightened once the contact is made.

Hardening bonding material

(As thin as possible) the film of glue fills the joint. The gluing can be done after the edges are brought together.

2. Preparation

The preparation of bonding surfaces is of significant importance for the bonding strength. The surfaces must be adapted to each other and available in plain, clean form.

Careful removal of

Adhesive remnants, oil, fat, separating agents, dirt, dust, scales, molding layers, protective coating, finish, paint, sweat etc.

Mechanical support

Stripping, brushing, scraping, grinding, sandblasting.

Chemical support

Degreasing (washing off with grease remover), etching, priming; pay attention to chemical resistancy on the following page!

In general, SLAB damping pads in sheet form can be bonded without pretreatment. Molded parts, with or without special skin, have to be cleaned from left-over separating agents, if necessary by grinding. When bonding with other materials like plastic, wood, metal or concrete, mechanical and/or chemical additives have to be used.

The adhesive has to be prepared according to the formula, observing the manufacturer's recommendations. The adhesive film is also to be carefully applied pursuant to these details. (Tools: brush, spatula, adhesive spreader, airless spray gun).

Contact bonding material

Apply the non-gap-filling adhesive film to both bonding surfaces – the thinner, the better. To close the pores of low density materials, two layers may be necessary.

Hardening bonding material

Apply evenly. Possible irregularities can be compensated by the film thickness.

3. Bonding

When using contact bonding material, the flash off time has to be kept in mind. Especially, with systems containing water instead of usual solvents, the adhesive film must be as dry as possible in order to pass the 'finger test' – no marks appear when touching the adhesive surface. When using hardening bonding material, the parts have to be joined immediately after applying the bonding material.

4. Pressing

Contact bonding material Contact pressure up to 2.85 in/lb²
Hardening bonding material Fix firmly

It is important to carefully follow the manufacturer's instructions with regard to processing temperature, hardening time and earliest possible loading.

5. Selection of Approved Bonding Materials

Because of the variety of materials that can be bonded together as well as numerous suitable bonding materials, we refer you to a worldwide leading producer of bonding and sealing materials.

Sika U.S.
 Sika Corporation
 201 Polito Avenue
 Lyndhurst, NJ 07071
 T +1 (800) 933-SIKA (7452)
www.usa.sika.com

Chemical Resistance

Test (following DIN 53428)

Exposure time of the medium: 6 weeks at room temperature, but for concentrated acids and bases as well as solvents: 7 days at room temperature

Evaluation Criteria

Changing of tensile strength and elongation of break (dry samples), change in volume

Evaluation Standard

- | | |
|---------------------------------|---|
| 1 Excellent resistance | change in characteristics <10 % |
| 2 Good resistance | change in characteristics between 10 % and 20 % |
| 3 Conditional resistance | change in characteristics partly above 20 % |
| 4 Not resistant | change in characteristics all above 20 % |

All information is based on our current knowledge and experiences. We reserve the rights for changes towards product refinement.

Chemical Resistance

Water/Watery Solutions

SL-030 to SL-300

| | |
|--------------------------|---|
| Water | 1 |
| Iron (III) chloride 10 % | 1 |
| Sodium carbonate | 1 |
| Sodium chlorate 10 % | 1 |
| Sodium chloride 10 % | 1 |
| Sodium nitrate 10 % | 1 |
| Tensides (div.) | 1 |
| Hydrogen peroxide 3 % | 1 |
| Laitance | 1 |

Oils and Greases

| | |
|---------------------------|----------------------------------|
| ASTM Oil No. 1 | 1 |
| ASTM Oil No. 3 | 1 |
| Laitance | 2 |
| Hydraulic oils | depends on consistency/additives |
| Motor oil | 1 |
| Formwork oil | 1 |
| High performance grease | 1-2 |
| Railroad switch lubricant | 1-2 |

Acids and Bases

| | |
|-----------------------------|---|
| Formic acid 5 % | 3 |
| Acetic acid 5 % | 2 |
| Phosphoric acid 5 % | 1 |
| Nitic acid 5 % | 4 |
| Hydrochloric acid 5 % | 1 |
| Sulphuric acid 5 % | 1 |
| Ammonia solution 5 % | 1 |
| Caustic potash solution 5 % | 1 |
| Caustic soda solution 5 % | 1 |

Solvents

SL-030 to SL-300

| | |
|--------------------------|-----|
| Acetone | 4 |
| Diesel/Fuel oil | 2 |
| Carburetor fuel/Benzine | 3 |
| Glycerin | 1 |
| Glycols | 1-2 |
| Cleaning solvents/Hexane | 1 |
| Methanol | 3 |
| Aromatic hydrocarbons | 4 |

Other Factors

| | |
|-----------------------------|-----|
| Hydrolysis * | 1 |
| Ozone | 1 |
| UV radiation and weathering | 1-2 |
| Biological resistance | 1 |

* 28 days, 158 °F, 95 % relative humidity

Sample Pads and Kits

Sample Kits

| Part Number | Description | Dimensions |
|-------------|-------------------------|--|
| 250-0800 | SL-030-12 Sample Kit | 1.97 x 1.97 in / 2.78 x 2.78 in / 3.94 x 3.94 in x 0.49 in |
| 250-0801 | SL-030-25 Sample Kit | 1.97 x 1.97 in / 2.78 x 2.78 in / 3.94 x 3.94 in x 0.49 in |
| 250-0802 | SL-100-12 Sample Kit | 1.97 x 1.97 in / 2.78 x 2.78 in / 3.94 x 3.94 in x 0.49 in |
| 250-0803 | SL-100-25 Sample Kit | 1.97 x 1.97 in / 2.78 x 2.78 in / 3.94 x 3.94 in x 0.49 in |
| 250-0804 | SL-300-12 Sample Kit | 1.97 x 1.97 in / 2.78 x 2.78 in / 3.94 x 3.94 in x 0.49 in |
| 250-0805 | SL-300-25 Sample Kit | 1.97 x 1.97 in / 2.78 x 2.78 in / 3.94 x 3.94 in x 0.49 in |
| 250-0806 | SL-170-12/25 Sample Kit | 8.66 in x 5.91 in x 0.49 in & 0.98 in |
| 250-0807 | SL-210-12/25 Sample Kit | 8.66 in x 5.91 in x 0.49 in & 0.98 in |
| 250-0808 | SL-275-12/25 Sample Kit | 8.66 in x 5.91 in x 0.49 in & 0.98 in |
| 250-0809 | SL-450-12/25 Sample Kit | 8.66 in x 5.91 in x 0.49 in & 0.98 in |
| 250-0810 | SL-600-12/25 Sample Kit | 8.66 in x 5.91 in x 0.49 in & 0.98 in |
| 250-0811 | SL-720-12/25 Sample Kit | 8.66 in x 5.91 in x 0.49 in & 0.98 in |

Additional Information

50 x 50 mm, 70.7 x 70.7 mm, 100 x 100 mm kits include 1 sample each of the MP1, MP2 and MP3.
 220 mm x 150 mm x 12.5 mm & 25 mm kits include 1 sample each of the 12 and 25 MP4.

Shock Absorption Samples (Sold Separately)

| Part Number | Description | Dimensions |
|-----------------|----------------------|---------------------|
| SL-030-12-D-MP1 | SL-030-12-D-MP1 | 1.97 in x 1.97 in |
| SL-030-12-D-MP2 | SL-030-12-D-MP2 | 2.78 in x 2.78 in |
| SL-030-12-D-MP3 | SL-030-12-D-MP3 | 3.94 in x 3.94 in |
| SL-030-12-D-MP4 | SL-030-12-D-MP4 | 8.66 in x 5.91 in |
| | SL-030-12-D-MP4-V+K* | 8.66 in x 5.91 in |
| SL-030-12-D-MP5 | SL-030-12-D-MP5 | 59.06 in x 31.50 in |
| SL-030-25-D-MP1 | SL-030-25-D-MP1 | 1.97 in x 1.97 in |
| SL-030-25-D-MP2 | SL-030-25-D-MP2 | 2.78 in x 2.78 in |
| SL-030-25-D-MP3 | SL-030-25-D-MP3 | 3.94 in x 3.94 in |
| SL-030-25-D-MP4 | SL-030-25-D-MP4 | 8.66 in x 5.91 in |
| SL-030-25-D-MP5 | SL-030-25-D-MP5 | 59.06 in x 31.50 in |
| SL-100-12-D-MP1 | SL-100-12-D-MP1 | 1.97 in x 1.97 in |
| SL-100-12-D-MP2 | SL-100-12-D-MP2 | 2.78 in x 2.78 in |
| SL-100-12-D-MP3 | SL-100-12-D-MP3 | 3.94 in x 3.94 in |
| SL-100-12-D-MP4 | SL-100-12-D-MP4 | 8.66 in x 5.91 in |
| | SL-100-12-D-MP4-V+K* | 7.87 in x 5.91 in |
| SL-100-12-D-MP5 | SL-100-12-D-MP5 | 59.06 in x 31.50 in |
| SL-100-25-D-MP1 | SL-100-25-D-MP1 | 1.97 in x 1.97 in |
| SL-100-25-D-MP2 | SL-100-25-D-MP2 | 2.78 in x 2.78 in |
| SL-100-25-D-MP3 | SL-100-25-D-MP3 | 3.94 in x 3.94 in |
| SL-100-25-D-MP4 | SL-100-25-D-MP4 | 8.66 in x 5.91 in |
| SL-100-25-D-MP5 | SL-100-25-D-MP5 | 59.06 in x 31.50 in |
| SL-300-12-D-MP1 | SL-300-12-D-MP1 | 1.97 in x 1.97 in |
| SL-300-12-D-MP2 | SL-300-12-D-MP2 | 2.78 in x 2.78 in |
| SL-300-12-D-MP3 | SL-300-12-D-MP3 | 3.94 in x 3.94 in |
| SL-300-12-D-MP4 | SL-300-12-D-MP4 | 8.66 in x 5.91 in |
| | SL-300-12-D-MP4-V+K* | 7.87 in x 5.91 in |
| SL-300-12-D-MP5 | SL-300-12-D-MP5 | 59.06 in x 31.50 in |
| SL-300-25-D-MP1 | SL-300-25-D-MP1 | 1.97 in x 1.97 in |
| SL-300-25-D-MP2 | SL-300-25-D-MP2 | 2.78 in x 2.78 in |
| SL-300-25-D-MP3 | SL-300-25-D-MP3 | 3.94 in x 3.94 in |
| SL-300-25-D-MP4 | SL-300-25-D-MP4 | 8.66 in x 5.91 in |
| SL-300-25-D-MP5 | SL-300-25-D-MP5 | 59.06 in x 31.50 in |

* Has a layer for wear protection & adhesive on one side

Vibration Isolation Samples (Sold Separately)

| Part Number | Description | Dimensions |
|-----------------|-----------------|-------------------|
| SL-170-12-F-MP4 | SL-170-12-F-MP4 | 8.66 in x 5.91 in |
| SL-170-25-F-MP4 | SL-170-25-F-MP4 | 8.66 in x 5.91 in |
| SL-210-12-F-MP4 | SL-210-12-F-MP4 | 8.66 in x 5.91 in |
| SL-210-25-F-MP4 | SL-210-25-F-MP4 | 8.66 in x 5.91 in |
| SL-275-12-F-MP4 | SL-275-12-F-MP4 | 8.66 in x 5.91 in |
| SL-275-25-F-MP4 | SL-275-25-F-MP4 | 8.66 in x 5.91 in |
| SL-450-12-F-MP4 | SL-450-12-F-MP4 | 8.66 in x 5.91 in |
| SL-450-25-F-MP4 | SL-450-25-F-MP4 | 8.66 in x 5.91 in |
| SL-600-12-F-MP4 | SL-600-12-F-MP4 | 8.66 in x 5.91 in |
| SL-600-25-F-MP4 | SL-600-25-F-MP4 | 8.66 in x 5.91 in |
| SL-720-12-F-MP4 | SL-720-12-F-MP4 | 8.66 in x 5.91 in |
| SL-720-25-F-MP4 | SL-720-25-F-MP4 | 8.66 in x 5.91 in |

Application Examples

SL-030, TA

Damping combination SLAB and TUBUS

SLAB-TUBUS-Combination ensures fast luggage transport. Airports strive to shorten air passengers' waiting times as much as possible. This goal is met with a solution specially developed for luggage transport systems and has solved previous damping issues. Transport carriers with a weight of up to 265 lbs can now be moved at the desired conveyor belt speeds. A SLAB-combination of the material SL-030-12(25) together with two TA40-16 type TUBUS profile dampers are used here.



Fast luggage transport for airport customers

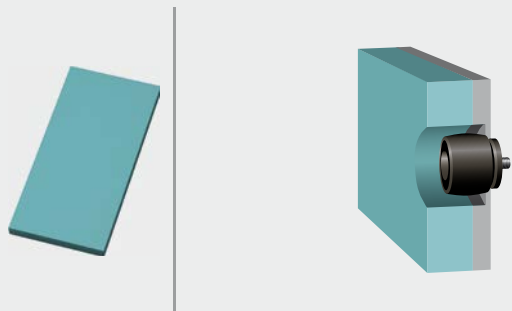

SL-030

Noise reduction

ACE-SLAB damping pads protect man and machine. At the beginning of the construction phase of a modern processing center at the end position, a 55 lb cable channel collided with force against the housing and produced a deafening noise and mechanical strain on the energy chain. A reliable solution for compliance with the operational parameters was realized with the SL-030-25 ACE-SLAB damping pads even before the milling machine was finished.



Low-noise energy chain

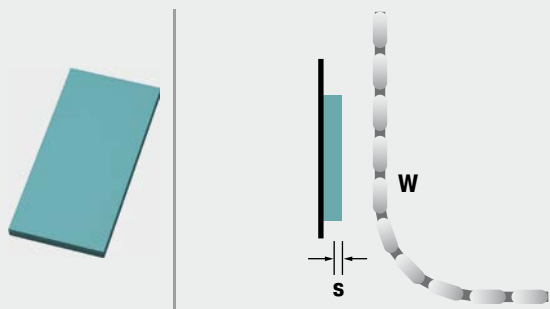

SL-030

Impact reduction in ring form

ACE-SLAB damping pads make tire transport safer. Developed for absorbing the impact of forces, the ACE-SLAB damping pads SL-030-121 applied in this tire testing system are ideal for protecting the sliding parts of the machine during quality tests. The individual customization of the ring form of the center arm and simple integration into the equipment also support the decision for applying these innovative absorber elements.

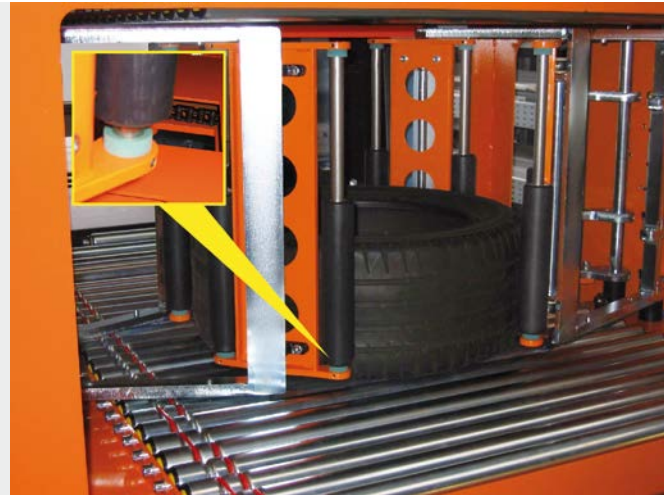

Perfectly fitted machine protection
SDS Systemtechnik GmbH, 75365 Calw, Germany

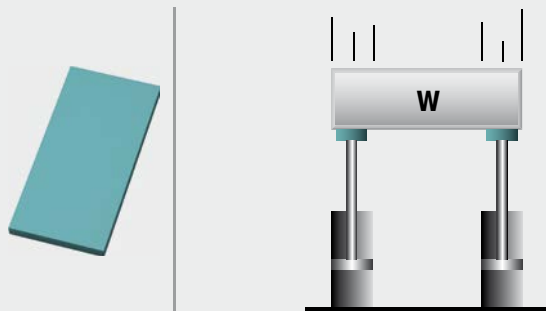

SL-030

Impact protection for large areas

ACE-SLAB damping pads offer impact protection for wooden battens. To protect wooden battens with differing weights and impact speeds of approx. 6.5 in/s, the SLAB-material SL-030-12 was screwed across the whole surface between two steel sheets in this application. This creates an even damping effect over the whole impact area, which protects the impact surfaces of the battens from an excessive impact load. The minimisation of recoil as well as reduction of noise are further positive side effects of this construction.



Impact protection for wooden battens

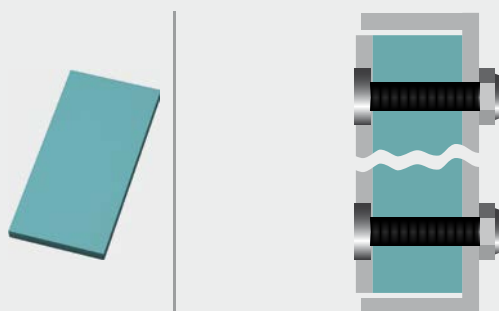

Motion Control

Gas Springs – Push Type, Gas Springs – Pull Type
Hydraulic Dampers, Hydraulic Feed Controls
Rotary Dampers



Custom Control of Hand Forces

Customized to suit your applications

The ACE products in this segment enhance the quality of any type of movement. Anyone who wants to raise or lower loads, regulate the feed of an object to the precise millimeter or gently decelerate rotating or linear movements will find the right solution here.

ACE delivers industry leading quality. Our innovative solutions correspond with stringent requirements for ergonomics and individuality, including custom pressurized gas springs.



Industrial Gas Springs – Push Type

The smart way to lift and lower

Anyone who wants to lift or lower loads with control and without excessive strength relies on the industrial gas springs from ACE. These maintenance-free, ready-to-install machine elements, which are available from stock, support sheer muscle power, reliably open and hold.

Available with body diameters of 0.31" to 2.76" (8 to 70 mm) and forces from 2 to 2,925 lbs. (10 to 13,000 N), ACE push type gas springs offer a huge variety and maximum service life. The first is achieved thanks to the number of available connections and fittings for simple attachment and the latter with high quality design and materials. Whether they are made of steel or stainless steel, these components make any work easier and are also visually appealing.

Ready-to-install and universally applicable

Modular end fittings and mounting brackets

Calculation program for individual design

Standard with fill/DE-Gas valve

Maintenance-free

Large variety in stock



Function of a Gas Spring – Push Type

ACE gas springs are individually filled to a predetermined pressure to suit a customer's requirement (extension Force F_1). The cross-sectional area of the piston rod and filling pressure determines the extension force.

During the compression of the piston rod, nitrogen flows through an orifice in the piston from the full bore side of the piston to the annulus. The nitrogen is compressed by the volume of the piston rod. As the piston rod is compressed the pressure increases, so increasing the reaction force (progression). The force depends on the proportional relationship between the piston rod and the inner tube diameter, which is approximately linear.

Calculation Principles

Force-Stroke Characteristics of Gas Spring (Push Type)

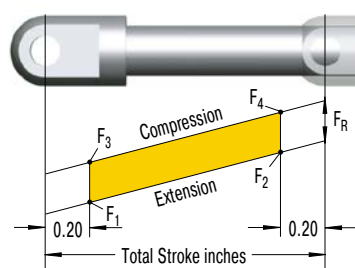

Free calculation service see page 188!

F_1 = nominal force at 68 °F
(this is the pressure figure normally used when specifying the gas spring)

F_2 = force in the complete compressed position

When compressing the piston rod, there is an additional friction force caused by the contact pressure of the seals (this **only** occurs **during the compression stroke**):

F_3 = force at the beginning of the compression stroke

F_4 = force at the end of the compression stroke

Gas Springs (Push Type)

| TYPES | Progression approx. % | ¹ Friction F_R approx. in lbs |
|-------|-----------------------|--|
| GS-8 | 29 - 33 ² | 2.25 |
| GS-10 | 13 - 16 ² | 2.25 |
| GS-12 | 20 - 35 ² | 4.50 |
| GS-15 | 30 - 40 ² | 4.50 |
| GS-19 | 24 - 35 ² | 6.74 |
| GS-22 | 30 - 40 ² | 6.74 |
| GS-28 | 63 - 76 ² | 8.99 |
| GS-40 | 38 - 50 ² | 11.24 |
| GS-70 | 25 | 11.24 |

¹ Depending on the filling force

² Depending on the stroke

Progression: (the slope of the force line in the diagram above) is due to the reduction of the internal gas volume as the piston rod moves from its initial position to its fully stroked position. The approx. progression values given above for standard springs can be altered on request.

Effect of temperature: The nominal F_1 figure is given at 68 °F. An increase of 50 °F will increase force by 3.4 %.

Filling tolerances: -4.50 lbs to +8.99 lbs or 5 % to 7 %. Depending on size and extension force the tolerances can differ.

Industrial Gas Springs – Push Type



GS-8 to GS-70

Valve Technology

Individual stroke length and extension forces

Hoods, Shutters, Machine housing, Conveyor systems

Page 150



GS-8-V4A to GS-40-VA

Valve Technology, Stainless Steel

With food grade oil for FDA compliance

Hoods, Shutters, Machine housing, Conveyor systems

Page 160



GST-40 Tandem

Valve Technology

Optimized dual force for heavy flaps and wide angle applications

Hoods, Shutters, Machine housing, Conveyor systems

Page 170

GS-8 to GS-70

Individual stroke length and extension forces

Valve Technology

Extension force 2 lbs to 2,923 lbs

Stroke 0.79 in to 39.37 in

Universal and tailor made: ACE industrial gas springs offer perfect support of muscle power with forces from 2 to 2,923 lbs. (10 to 13,000 N) with body diameter of 0.31" to 2.76" (8 to 70 mm). These durable and sealed systems are ready for installation, maintenance-free and filled with pressurized nitrogen gas.

They are filled according to individual customer pressure requirements and may be adjusted later by use of a built-in valve. ACE provides free calculation support and designs the gas springs with mounting points specifically for the particular application. A variety of accessories makes assembly even easier and allows universal application of the gas springs.

ACE industrial gas push type springs are used on covers, lids, or other components. They are used in industrial applications, automation and machine building, medical technology as well as in the electronics, automobile and furniture industries.

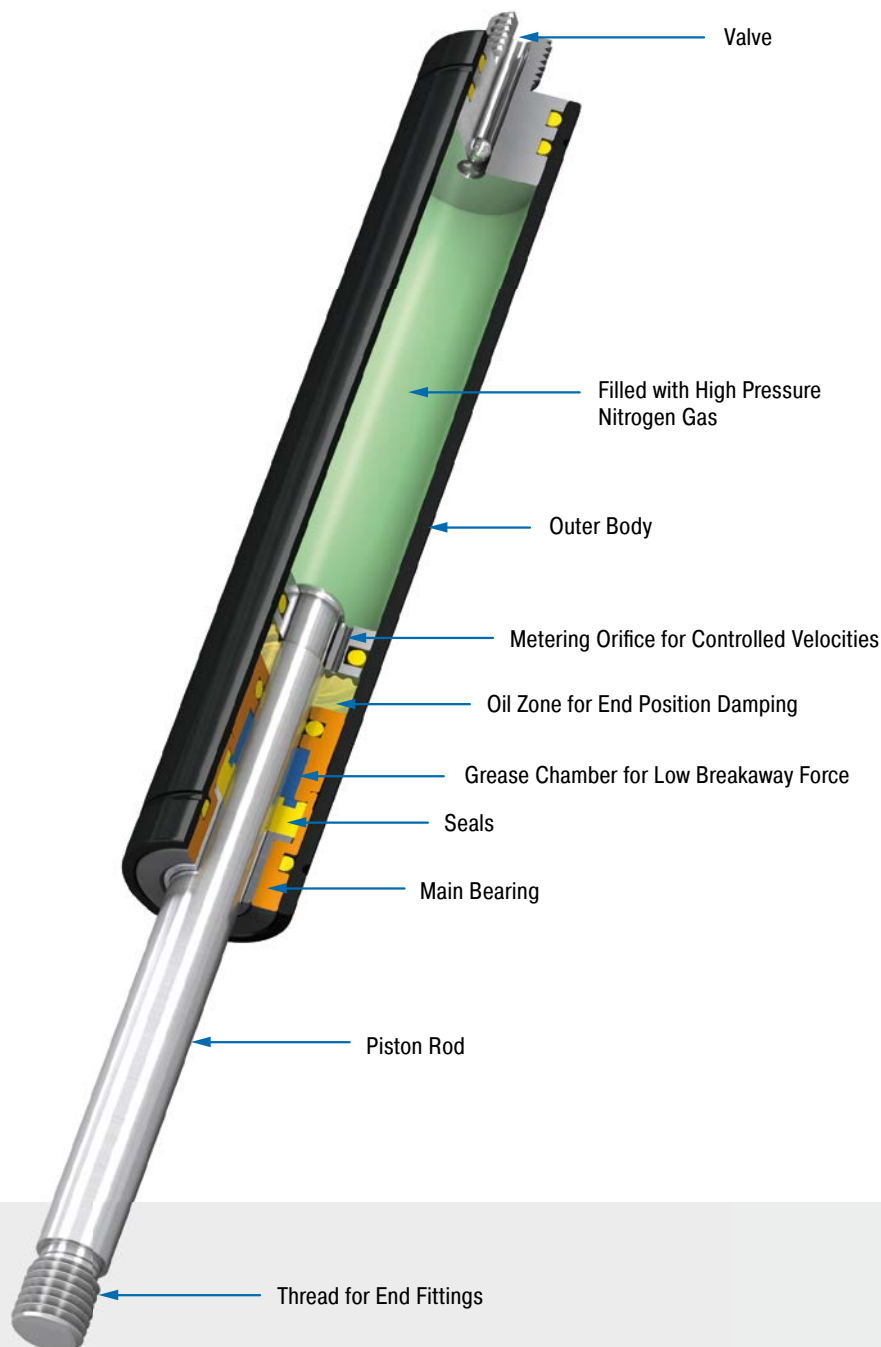

Technical Data

Extension force: 2 lbs to 2,923 lbs

Piston rod diameter: Ø 0.12 in to Ø 1.18 in

Progression: Approx. 13 % to 76 % (depending on size and stroke)

Lifetime: Approx. 250,000 cycles

Operating temperature range: -4 °F to 176 °F

Material: Outer body: Coated steel; Piston rod: Steel or stainless steel with wear-resistant coating; End fittings: Zinc plated steel

Operating fluid: Nitrogen gas and oil

Mounting: We recommend mounting with piston rod downwards to take advantage of the built-in end position damping.

End position damping length: Approx. 20 % to 67 % (depending on size and stroke)

Positive stop: External positive stop at the end of stroke provided by the customer.

Application field: Hoods, Shutters, Machine housing, Conveyor systems, Control boxes, Furniture industry, Jacking applications, Assembly stations, Vehicle technology, Folding elements

Note: Increased break-away force if unit has not moved for some time.

End fittings: They are interchangeable and if necessary must be positively secured by the customer to prevent unscrewing.

Safety information: Gas springs (push type) should not be installed under pre-tension.

On request: Special oils and other special options. Alternative accessories. Different end position damping and extension speed.

Valve Technology , Extension force 2 lbs to 22 lbs (compressed up to 30 lbs)

End Fitting

Standard Dimensions

End Fitting

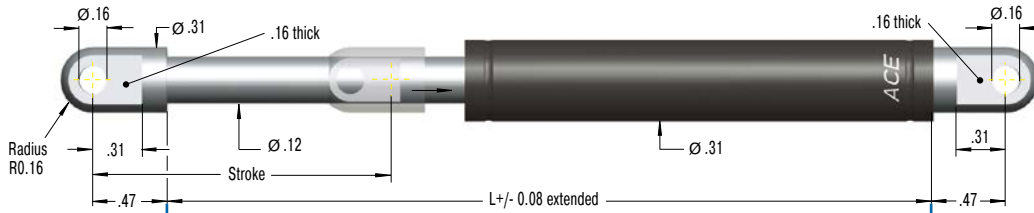
A3.5

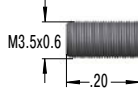
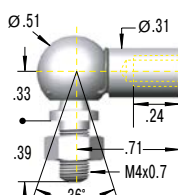
Eye A3.5
max. force 83 lbs

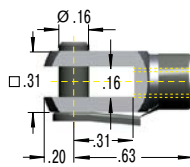
B3.5

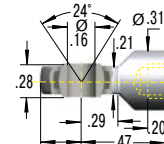
Stud Thread B3.5
C3.5

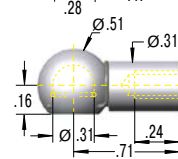
Angle Ball Joint C3.5
max. force 83 lbs

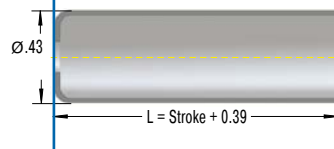
D3.5

Clevis Fork D3.5
max. force 83 lbs

E3.5

Swivel Eye E3.5
max. force 83 lbs

G3.5

Ball Socket G3.5
max. force 83 lbs

Rod Shroud W3.5-8

Performance and Dimensions

| TYPES | Stroke inch | L extended inch | Extension force max. lbs |
|---------|----------------|--------------------|-----------------------------|
| GS-8-20 | 0.79 | 2.83 | 22 |
| GS-8-30 | 1.18 | 3.62 | 22 |
| GS-8-40 | 1.57 | 4.41 | 22 |
| GS-8-50 | 1.97 | 5.20 | 22 |
| GS-8-60 | 2.36 | 5.98 | 22 |
| GS-8-80 | 3.14 | 7.56 | 22 |

Ordering Example

GS-8-30-AC-30

Type (Push Type) _____
 Body 0.31" (8 mm) _____
 Stroke 1.18" (30 mm) _____
 Piston Rod End Fitting A3.5 _____
 Body End Fitting C3.5 _____
 Nominal Force F₁ 7 lbs (30 N) _____

Mounting accessories see from page 212.

Adjuster Knob DE-GAS-3.5

See page 191.

Technical Data

Extension force: 2 lbs to 22 lbs (compressed up to 30 lbs)

Progression: Approx. 29 % to 33 %

Operating temperature range: -4 °F to 176 °F

Material: Outer body: Coated steel; Piston rod: Stainless steel (1.4301/1.4305, AISI 304/303); End fittings: Zinc plated steel

Mounting: We recommend mounting with piston rod downwards to take advantage of the built-in end position damping.

End position damping length: approx. 0.2" (depending on the stroke)

Positive stop: External positive stop at the end of stroke provided by the customer.

Note: Increased break-away force if unit has not moved for some time.

End fittings: They are interchangeable and if necessary must be positively secured by the customer to prevent unscrewing.

Safety information: Gas springs (push type) should not be installed under pre-tension.

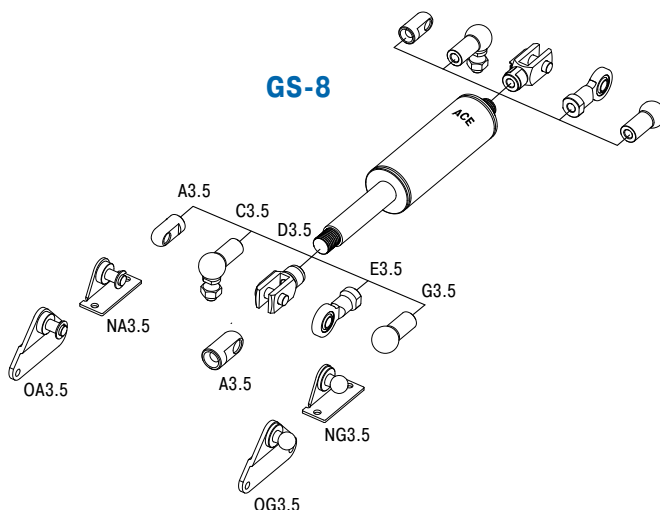

Valve Technology, Extension force 2 lbs to 22 lbs (compressed up to 26 lbs)

End Fitting

Standard Dimensions

End Fitting

A3.5

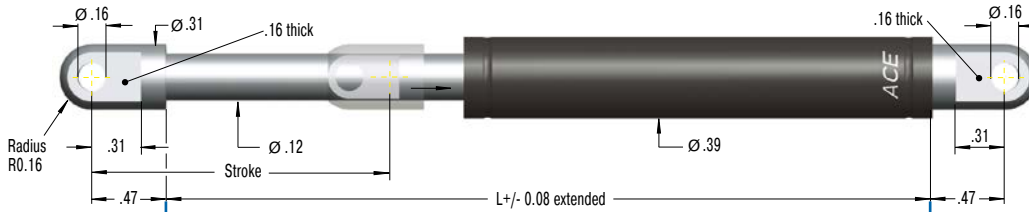

Eye A3.5
max. force 83 lbs

B3.5

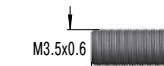

Stud Thread B3.5

C3.5

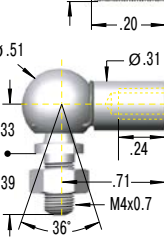

Angle Ball Joint C3.5
max. force 83 lbs

D3.5

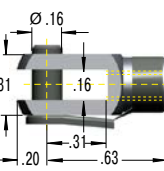

Clevis Fork D3.5
max. force 83 lbs

E3.5

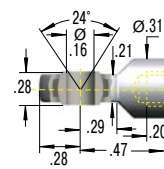

Swivel Eye E3.5
max. force 83 lbs

G3.5

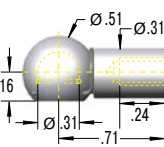

Ball Socket G3.5
max. force 83 lbs

Rod Shroud
W3.5-10

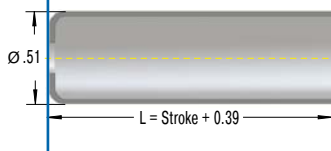

Performance and Dimensions

| TYPES | Stroke inch | L extended inch | Extension force max. lbs |
|----------|----------------|--------------------|-----------------------------|
| GS-10-20 | 0.79 | 2.83 | 22 |
| GS-10-30 | 1.18 | 3.62 | 22 |
| GS-10-40 | 1.57 | 4.41 | 22 |
| GS-10-50 | 1.97 | 5.20 | 22 |
| GS-10-60 | 2.36 | 5.98 | 22 |
| GS-10-80 | 3.15 | 7.56 | 22 |

Ordering Example

Type (Push Type) → GS-10-80-AC-60
 Body 0.39" (10 mm)
 Stroke 3.15" (80 mm)
 Piston Rod End Fitting A3.5
 Body End Fitting C3.5
 Nominal Force F₁ 13 lbs (60 N)

Mounting accessories see from page 212.

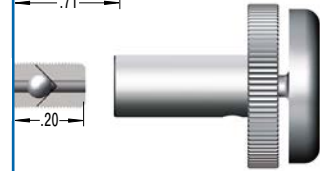

Adjuster Knob
DE-GAS-3.5
See page 191.

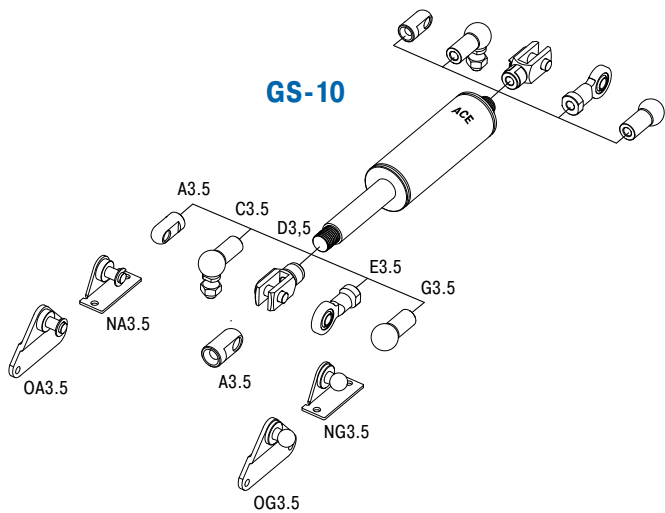

Technical Data

- Extension force:** 2 lbs to 22 lbs (compressed up to 26 lbs)
- Progression:** Approx. 13 % to 16 %
- Operating temperature range:** -4 °F to 176 °F
- Material:** Outer body: Coated steel; Piston rod: Stainless steel (1.4301/1.4305, AISI 304/303); End fittings: Zinc plated steel
- Mounting:** We recommend mounting with piston rod downwards to take advantage of the built-in end position damping.
- End position damping length:** approx. 0.2" (depending on the stroke)
- Positive stop:** External positive stop at the end of stroke provided by the customer.
- Note:** Increased break-away force if unit has not moved for some time.
- End fittings:** They are interchangeable and if necessary must be positively secured by the customer to prevent unscrewing.
- Safety information:** Gas springs (push type) should not be installed under pre-tension.

Issue 04.2018 – Specifications subject to change

Valve Technology, Extension force 3 lbs to 40 lbs (compressed up to 55 lbs)

End Fitting

Standard Dimensions

End Fitting

A3.5

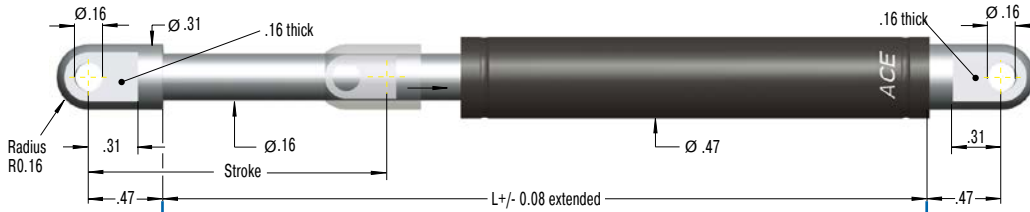

Eye A3.5
max. force 83 lbs

B3.5

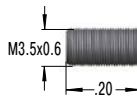

Stud Thread B3.5

C3.5

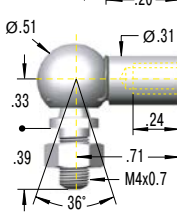

Angle Ball Joint C3.5
max. force 83 lbs

D3.5

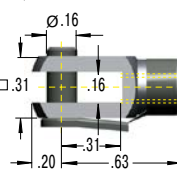

Clevis Fork D3.5
max. force 83 lbs

E3.5

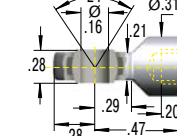

Swivel Eye E3.5
max. force 83 lbs

G3.5

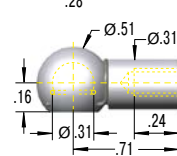

Ball Socket G3.5
max. force 83 lbs

Rod Shroud W3.5-12

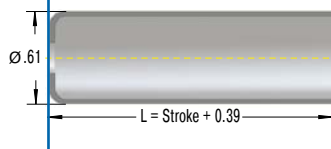

Performance and Dimensions

| TYPES | Stroke inch | L extended inch | Extension force max. lbs |
|-----------|----------------|--------------------|-----------------------------|
| GS-12-20 | 0.79 | 2.83 | 40 |
| GS-12-30 | 1.18 | 3.62 | 40 |
| GS-12-40 | 1.57 | 4.41 | 40 |
| GS-12-50 | 1.97 | 5.20 | 40 |
| GS-12-60 | 2.36 | 5.98 | 40 |
| GS-12-80 | 3.15 | 7.56 | 34 |
| GS-12-100 | 3.94 | 9.13 | 34 |
| GS-12-120 | 4.72 | 10.71 | 27 |
| GS-12-150 | 5.91 | 13.07 | 22 |

Ordering Example

GS-12-100-AA-30

Type (Push Type) _____
 Body 0.47" (12 mm) _____
 Stroke 3.94" (100 mm) _____
 Piston Rod End Fitting A3.5 _____
 Body End Fitting A3.5 _____
 Nominal Force F₁ 7 lbs (30 N) _____

Mounting accessories see from page 212.

Adjuster Knob DE-GAS-3.5

See page 191.

Technical Data

- Extension force:** 3 lbs to 40 lbs (compressed up to 55 lbs)
- Progression:** Approx. 20 % to 35 %
- Operating temperature range:** -4 °F to 176 °F
- Material:** Outer body: Coated steel; Piston rod: Stainless steel (1.4301/1.4305, AISI 304/303); End fittings: Zinc plated steel
- Mounting:** We recommend mounting with piston rod downwards to take advantage of the built-in end position damping.
- End position damping length:** approx. 0.39" (depending on the stroke)
- Positive stop:** External positive stop at the end of stroke provided by the customer.
- Note:** Increased break-away force if unit has not moved for some time.
- End fittings:** They are interchangeable and if necessary must be positively secured by the customer to prevent unscrewing.
- Safety information:** Gas springs (push type) should not be installed under pre-tension.

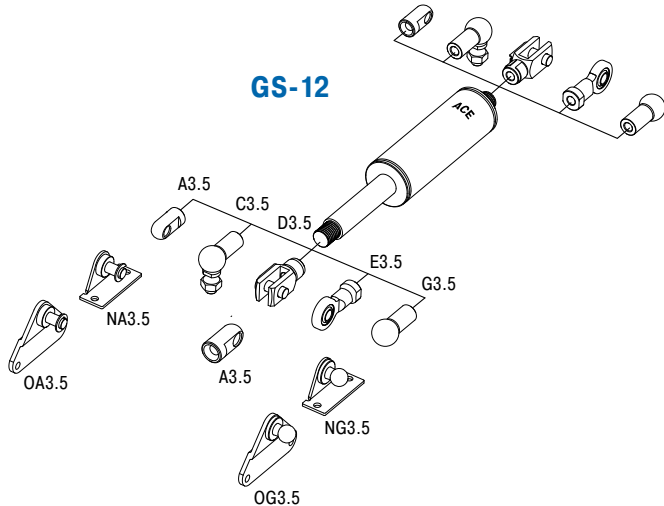

Valve Technology, Extension force 9 lbs to 90 lbs (compressed up to 126 lbs)

End Fitting

Standard Dimensions

End Fitting

A5

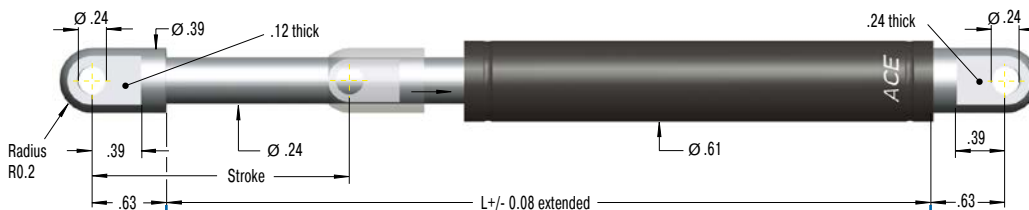

Eye A5
max. force 180 lbs

B5

C5

D5

E5

F5

G5

Rod Shroud
W5-15

Performance and Dimensions

| TYPES | Stroke inch | L extended inch | Extension force max. lbs |
|-----------|----------------|--------------------|-----------------------------|
| GS-15-20 | 0.79 | 2.64 | 90 |
| GS-15-40 | 1.57 | 4.21 | 90 |
| GS-15-50 | 1.97 | 5.00 | 90 |
| GS-15-60 | 2.36 | 5.79 | 90 |
| GS-15-80 | 3.15 | 7.36 | 90 |
| GS-15-100 | 3.94 | 8.94 | 90 |
| GS-15-120 | 4.72 | 10.51 | 90 |
| GS-15-150 | 5.91 | 12.87 | 90 |
| GS-15-200 | 7.87 | 16.81 | 79 |

Ordering Example

Type (Push Type) _____
 Body 0.61" (15.6 mm) _____
 Stroke 5.91" (150 mm) _____
 Piston Rod End Fitting A5 _____
 Body End Fitting C5 _____
 Nominal Force F₁ 34 lbs (150 N) _____

GS-15-150-AC-150

Mounting accessories see from page 212.

Adjuster Knob
DE-GAS-5
See page 191.

Stud Thread B5

Angle Ball Joint C5
max. force 112 lbs

Clevis Fork D5
max. force 180 lbs

Swivel Eye E5
max. force 180 lbs

Inline Ball Joint F5
max. force 112 lbs

Ball Socket G5
max. force 112 lbs

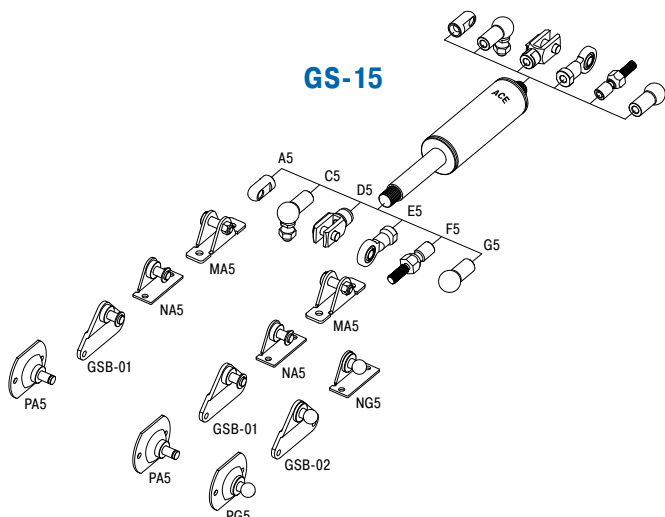

Technical Data

- Extension force:** 9 lbs to 90 lbs (compressed up to 126 lbs)
- Progression:** Approx. 30 % to 40 %
- Operating temperature range:** -4 °F to 176 °F
- Material:** Outer body: Steel coated with UV paint; Piston rod: Steel with wear-resistant coating; End fittings: Zinc plated steel
- Mounting:** We recommend mounting with piston rod downwards to take advantage of the built-in end position damping.
- End position damping length:** approx. 0.39" (depending on the stroke)
- Positive stop:** External positive stop at the end of stroke provided by the customer.
- Note:** Increased break-away force if unit has not moved for some time.
- End fittings:** They are interchangeable and if necessary must be positively secured by the customer to prevent unscrewing.
- Safety information:** Gas springs (push type) should not be installed under pre-tension.

Valve Technology, Extension force 11 lbs to 157 lbs (compressed up to 212 lbs)

End Fitting

Standard Dimensions

End Fitting

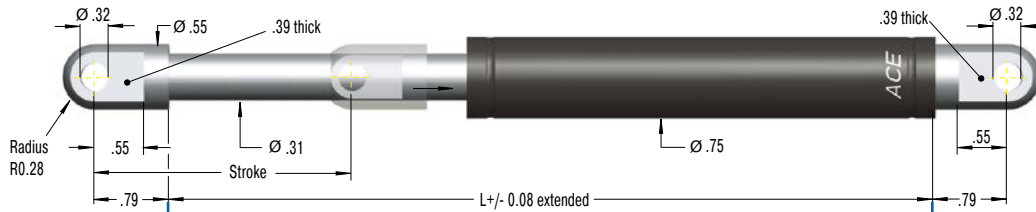
A8

Eye A8

max. force 674 lbs

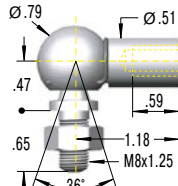
B8

Stud Thread B8
C8

Angle Ball Joint C8

max. force 270 lbs

Also available with

UNF thread 5/16-18.

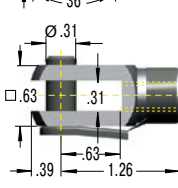
Order G5/16.

D8

Clevis Fork D8

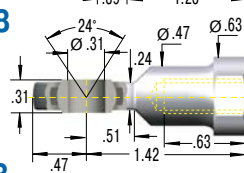
max. force 674 lbs

E8

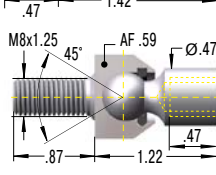
Swivel Eye E8

max. force 674 lbs

F8

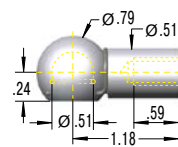
Inline Ball Joint F8

max. force 270 lbs

G8

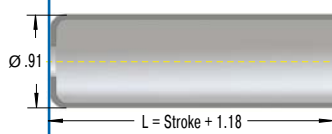
Ball Socket G8

max. force 270 lbs

Rod Shroud W8-19

Adjuster Knob DE-GAS-8

See page 191.

Performance and Dimensions

| TYPES | Stroke inch | L extended inch | Extension force max. lbs |
|-----------|----------------|--------------------|-----------------------------|
| GS-19-50 | 1.97 | 6.46 | 157 |
| GS-19-100 | 3.94 | 10.39 | 157 |
| GS-19-150 | 5.91 | 14.33 | 157 |
| GS-19-200 | 7.87 | 18.28 | 157 |
| GS-19-250 | 9.84 | 22.20 | 135 |
| GS-19-300 | 11.81 | 26.14 | 101 |

Ordering Example

GS-19-150-AC-600

Type (Push Type) _____
 Body 0.75" (19 mm) _____
 Stroke 5.91" (150 mm) _____
 Piston Rod End Fitting A8 _____
 Body End Fitting C8 _____
 Nominal Force F₁ 135 lbs (600 N) _____

Mounting accessories see from
page 212.

Technical Data

Extension force: 11 lbs to 157 lbs (compressed up to 212 lbs)

Progression: Approx. 24 % to 35 %

Operating temperature range: -4 °F to 176 °F

Material: Outer body: Steel coated with UV paint; Piston rod: Steel with wear-resistant coating; End fittings: Zinc plated steel

Mounting: In any position. Hint: We recommend mounting with piston rod downwards to take advantage of the built-in end position damping.

End position damping length: approx. 0.79" to 2.36" (depending on the stroke)

Positive stop: External positive stop at the end of stroke provided by the customer.

Note: Integrated grease chamber reduces friction and wear and optimizes lubrication.

End fittings: They are interchangeable and if necessary must be positively secured by the customer to prevent unscrewing.

Safety information: Gas springs (push type) should not be installed under pre-tension.

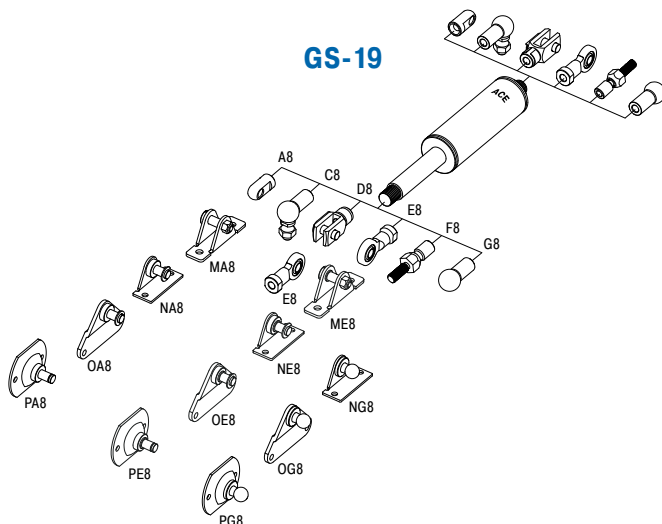
GS-19

Valve Technology, Extension force 18 lbs to 292 lbs (compressed up to 409 lbs)

End Fitting

Standard Dimensions

End Fitting

A8

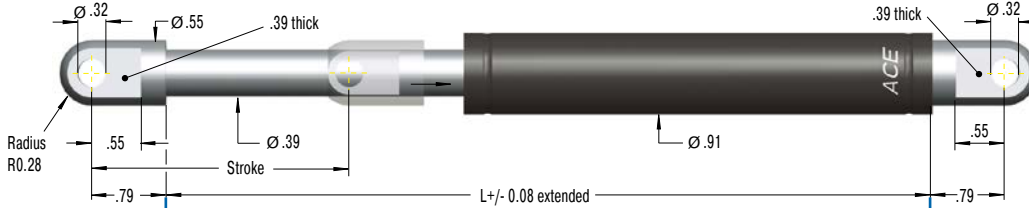

Eye A8
max. force 674 lbs

B8

C8

D8

E8

F8

G8

Rod Shroud
W8-22

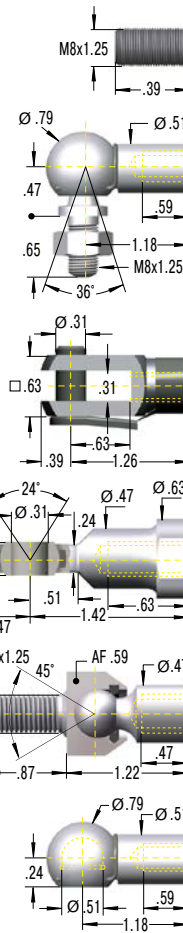

Performance and Dimensions

| TYPES | Stroke inch | L extended inch | Extension force max. lbs |
|-----------|----------------|--------------------|-----------------------------|
| GS-22-50 | 1.97 | 6.46 | 292 |
| GS-22-100 | 3.94 | 10.39 | 292 |
| GS-22-150 | 5.91 | 14.33 | 292 |
| GS-22-200 | 7.87 | 18.28 | 292 |
| GS-22-250 | 9.84 | 22.20 | 292 |
| GS-22-300 | 11.81 | 26.14 | 247 |
| GS-22-350 | 13.78 | 30.08 | 191 |
| GS-22-400 | 15.75 | 34.02 | 146 |
| GS-22-450 | 17.72 | 37.95 | 124 |
| GS-22-500 | 19.69 | 41.89 | 101 |
| GS-22-550 | 21.65 | 45.83 | 90 |
| GS-22-600 | 23.62 | 49.76 | 79 |
| GS-22-650 | 25.59 | 53.70 | 67 |
| GS-22-700 | 27.56 | 57.64 | 56 |

Ordering Example

Type (Push Type) _____
 Body 0.91" (23 mm) _____
 Stroke 5.91" (150 mm) _____
 Piston Rod End Fitting A8 _____
 Body End Fitting E8 _____
 Nominal Force F₁ 180 lbs (800 N) _____

GS-22-150-AE-800

Mounting accessories see from page 212.

Adjuster Knob
DE-GAS-8
See page 191.

Technical Data

- Extension force:** 18 lbs to 292 lbs (compressed up to 409 lbs)
- Progression:** Approx. 30 % to 40 %
- Operating temperature range:** -4 °F to 176 °F
- Material:** Outer body: Steel coated with UV paint; Piston rod: Steel with wear-resistant coating; End fittings: Zinc plated steel
- Mounting:** In any position. Hint: We recommend mounting with piston rod downwards to take advantage of the built-in end position damping.
- End position damping length:** approx. 0.79" to 2.76" (depending on the stroke)
- Positive stop:** External positive stop at the end of stroke provided by the customer.
- Note:** Integrated grease chamber reduces friction and wear and optimizes lubrication.
- End fittings:** They are interchangeable and if necessary must be positively secured by the customer to prevent unscrewing.
- Safety information:** Gas springs (push type) should not be installed under pre-tension.

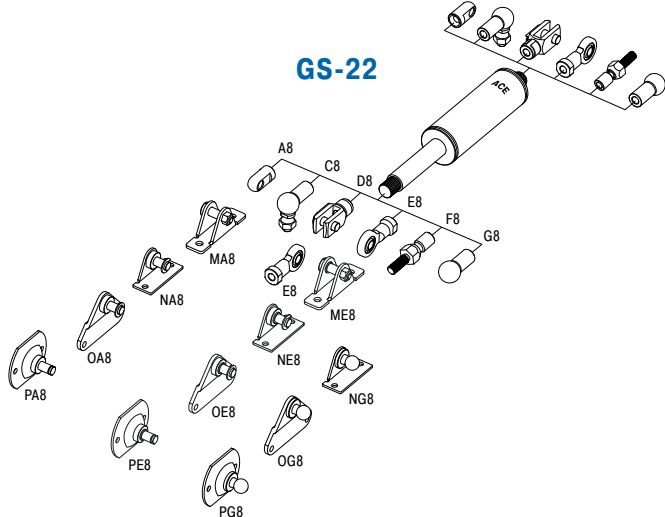

Valve Technology, Extension force 34 lbs to 562 lbs (compressed up to 989 lbs)

End Fitting

Standard Dimensions

End Fitting

A10

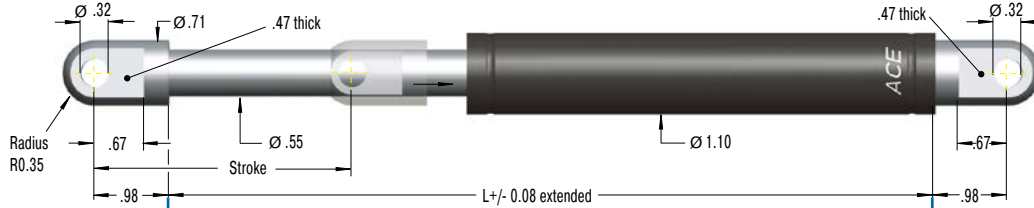

Eye A10
max. force 2,248 lbs

B10



Stud Thread B10

C10

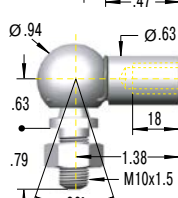

Angle Ball Joint C10
max. force 405 lbs

D10

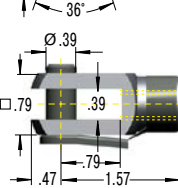

Clevis Fork D10
max. force 2,248 lbs

E10

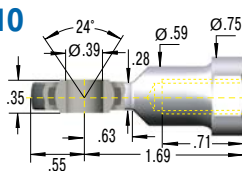

Swivel Eye E10
max. force 2,248 lbs

F10

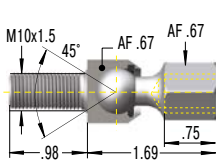

Inline Ball Joint F10
max. force 405 lbs

Rod Shroud W10-28

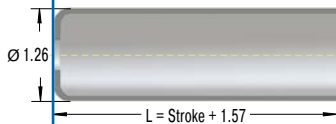

Adjuster Knob DE-GAS-10
See page 191.

Performance and Dimensions

| TYPES | Stroke inch | L extended inch | Extension force max. lbs |
|-----------|----------------|--------------------|-----------------------------|
| GS-28-100 | 3.94 | 10.31 | 562 |
| GS-28-150 | 5.91 | 14.25 | 562 |
| GS-28-200 | 7.87 | 18.19 | 562 |
| GS-28-250 | 9.84 | 22.13 | 562 |
| GS-28-300 | 11.81 | 26.06 | 562 |
| GS-28-350 | 13.78 | 30.00 | 562 |
| GS-28-400 | 15.75 | 33.94 | 540 |
| GS-28-450 | 17.72 | 37.87 | 438 |
| GS-28-500 | 19.69 | 41.81 | 360 |
| GS-28-550 | 21.65 | 45.75 | 303 |
| GS-28-600 | 23.62 | 49.69 | 259 |
| GS-28-650 | 25.59 | 53.62 | 225 |
| GS-28-700 | 27.56 | 57.56 | 202 |
| GS-28-750 | 29.53 | 61.50 | 180 |

Ordering Example

GS-28-150-EE-1200

Type (Push Type) _____
 Body 1.1" (28 mm) _____
 Stroke 5.91" (150 mm) _____
 Piston Rod End Fitting E10 _____
 Body End Fitting E10 _____
 Nominal Force F₁ 270 lbs (1,200 N) _____

Mounting accessories see from page 212.

Technical Data

Extension force: 34 lbs to 562 lbs (compressed up to 989 lbs)

Progression: Approx. 63 % to 76 %

Operating temperature range: -4 °F to 176 °F

Material: Outer body: Steel coated with UV paint; Piston rod: Steel with wear-resistant coating; End fittings: Zinc plated steel

Mounting: In any position. Hint: We recommend mounting with piston rod downwards to take advantage of the built-in end position damping.

End position damping length: approx. 1.18" to 2.76" (depending on the stroke)

Positive stop: External positive stop at the end of stroke provided by the customer.

Note: Integrated grease chamber reduces friction and wear and optimizes lubrication.

End fittings: They are interchangeable and if necessary must be positively secured by the customer to prevent unscrewing.

Safety information: Gas springs (push type) should not be installed under pre-tension.

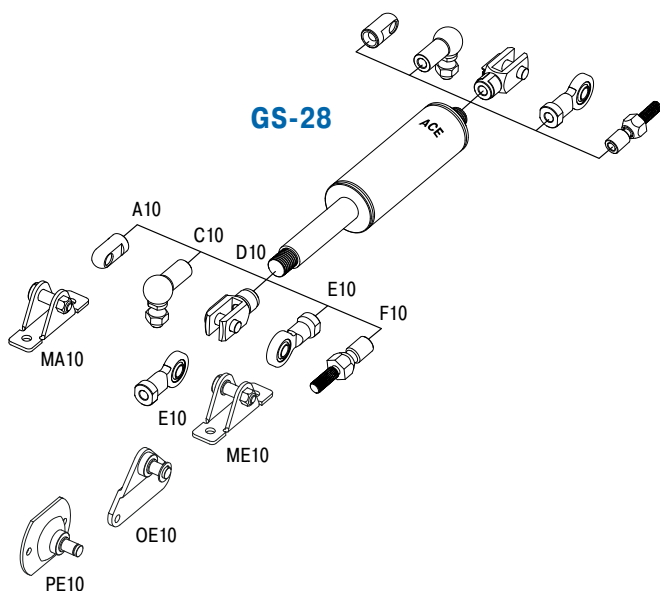

Valve Technology, Extension force 112 lbs to 1,124 lbs (compressed up to 1,686 lbs)

End Fitting

Standard Dimensions

End Fitting

A14

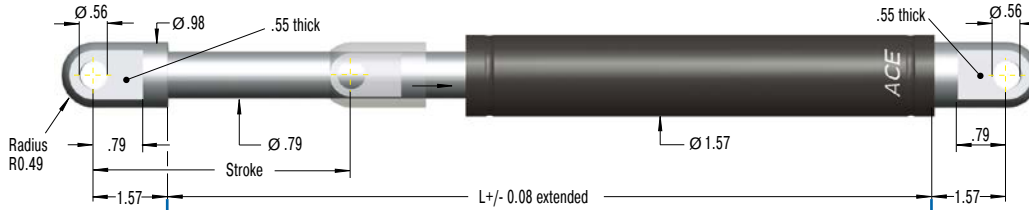

Eye A14
max. force 2,248 lbs

B14

C14

D14

E14

F14

Rod Shroud
W14-40

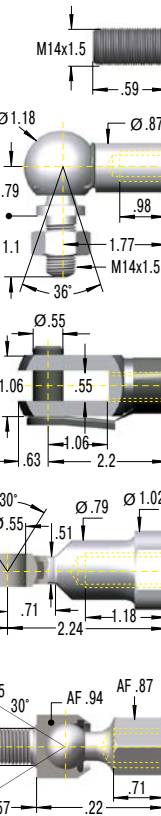

Performance and Dimensions

| TYPES | Stroke inch | L extended inch | Extension force max. lbs |
|------------|----------------|--------------------|-----------------------------|
| GS-40-100 | 3.94 | 12.48 | 1,124 |
| GS-40-150 | 5.91 | 16.42 | 1,124 |
| GS-40-200 | 7.87 | 20.35 | 1,124 |
| GS-40-250 | 9.84 | 24.29 | 1,124 |
| GS-40-300 | 11.81 | 28.23 | 1,124 |
| GS-40-400 | 15.75 | 36.10 | 1,124 |
| GS-40-500 | 19.69 | 43.98 | 1,124 |
| GS-40-600 | 23.62 | 51.85 | 933 |
| GS-40-800 | 32.50 | 67.60 | 573 |
| GS-40-1000 | 39.37 | 83.35 | 382 |

Ordering Example

GS-40-150-DD-3500

Type (Push Type) _____
 Body 1.57" (40 mm) _____
 Stroke 5.91" (150 mm) _____
 Piston Rod End Fitting D14 _____
 Body End Fitting D14 _____
 Nominal Force F_1 787 lbs (3,500 N) _____

Mounting accessories see from page 212.

Stud Thread B14

Angle Ball Joint C14
max. force 719 lbs

Clevis Fork D14
max. force 2,248 lbs

Swivel Eye E14
max. force 2,248 lbs

Inline Ball Joint F14
max. force 719 lbs

Adjuster Knob
DE-GAS-14
See page 191.

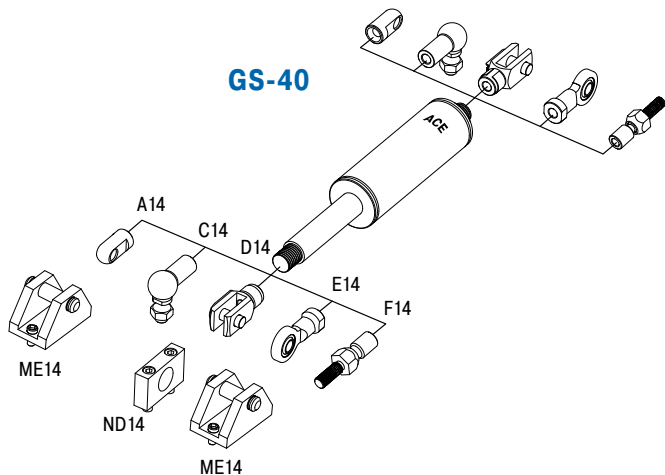
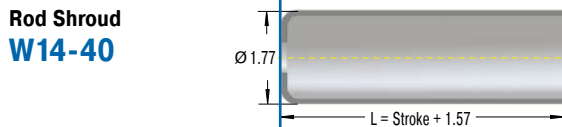

Technical Data

Extension force: 112 lbs to 1,124 lbs (compressed up to 1,686 lbs)

Progression: Approx. 38 % to 50 %

Operating temperature range: -4 °F to 176 °F

Material: Outer body: Steel coated with UV paint; Piston rod: Steel with wear-resistant coating; End fittings: Zinc plated steel

Mounting: In any position. Hint: We recommend mounting with piston rod downwards to take advantage of the built-in end position damping.

End position damping length: approx. 1.18" to 2.76" (depending on the stroke)

Positive stop: External positive stop at the end of stroke provided by the customer.

Note: Integrated grease chamber reduces friction and wear and optimizes lubrication.

End fittings: They are interchangeable and if necessary must be positively secured by the customer to prevent unscrewing.

Safety information: Gas springs (push type) should not be installed under pre-tension.

Valve Technology, Extension force 450 lbs to 2,923 lbs (compressed up to 3,653 lbs)

End Fitting

Standard Dimensions

End Fitting

B24 Stud Thread **B24**

D24 Clevis Fork **D24**
max. force 11,240 lbs

E24 Swivel Eye **E24**
max. force 11,240 lbs

Rod Shroud W24-70

$L = \text{Stroke} + 5.12$

| Performance and Dimensions | | | |
|----------------------------|----------------|--------------------|-----------------------------|
| TYPES | Stroke inch | L extended inch | Extension force max. lbs |
| GS-70-100 | 3.94 | 12.60 | 2,923 |
| GS-70-200 | 7.87 | 20.47 | 2,923 |
| GS-70-300 | 11.81 | 28.35 | 2,923 |
| GS-70-400 | 15.75 | 36.22 | 2,923 |
| GS-70-500 | 19.69 | 44.09 | 2,923 |
| GS-70-600 | 23.62 | 51.97 | 2,923 |
| GS-70-700 | 27.56 | 59.84 | 2,923 |
| GS-70-800 | 31.50 | 67.72 | 2,597 |

Ordering Example **GS-70-200-EE-8000**

Type (Push Type) _____

Body 2.76" (70 mm) _____

Stroke 7.87" (200 mm) _____

Piston Rod End Fitting E24 _____

Body End Fitting E24 _____

Nominal Force F_1 1,798 lbs (8,000 N) _____

Mounting accessories see from page 212.

Technical Data

Extension force: 450 lbs to 2,923 lbs (compressed up to 3,653 lbs)

Progression: Approx. 25 %

Operating temperature range: -4 °F to 176 °F

Material: Outer body: Coated steel; Piston rod: Hard chrome plated steel; End fittings: Zinc plated steel

Mounting: In any position. Hint: We recommend mounting with piston rod downwards to take advantage of the built-in end position damping.

End position damping length: approx. 0.39" to 0.79" (depending on the stroke)

Positive stop: External positive stop at the end of stroke provided by the customer.

Note: Increased break-away force if unit has not moved for some time.

End fittings: They are interchangeable and if necessary must be positively secured by the customer to prevent unscrewing.

Safety information: Gas springs (push type) should not be installed under pre-tension.

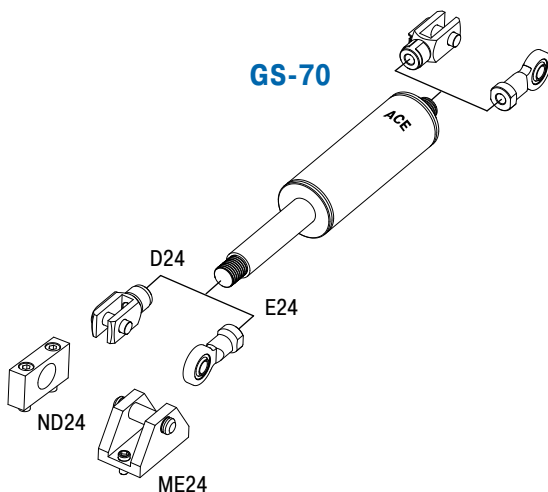

GS-8-V4A to GS-40-VA

With food grade oil for FDA compliance

Valve Technology, Stainless Steel

Extension force 2 lbs to 1,124 lbs

Stroke 0.79 in to 27.56 in

Protection against corrosion and superior visual appearance for even more sophisticated requirements: Based on ACE's industrial gas springs GS-8 to 40 made of steel, these models combine all advantages of stainless steel: they look great and are rust free. They are filled with food-grade oil as standard, which conforms to the requirements of FDA 21 CFR 178.3570.

These ACE gas springs not only look good, they are also available in various stroke lengths and extension forces. A comprehensive range of accessories in stainless steel guarantees easy assembly and a broad range of uses.

ACE stainless steel industrial gas springs are used in the automotive sector, in industrial applications, automation and machine building and medical clean room technology as well as in the food, electronics and shipbuilding industries.

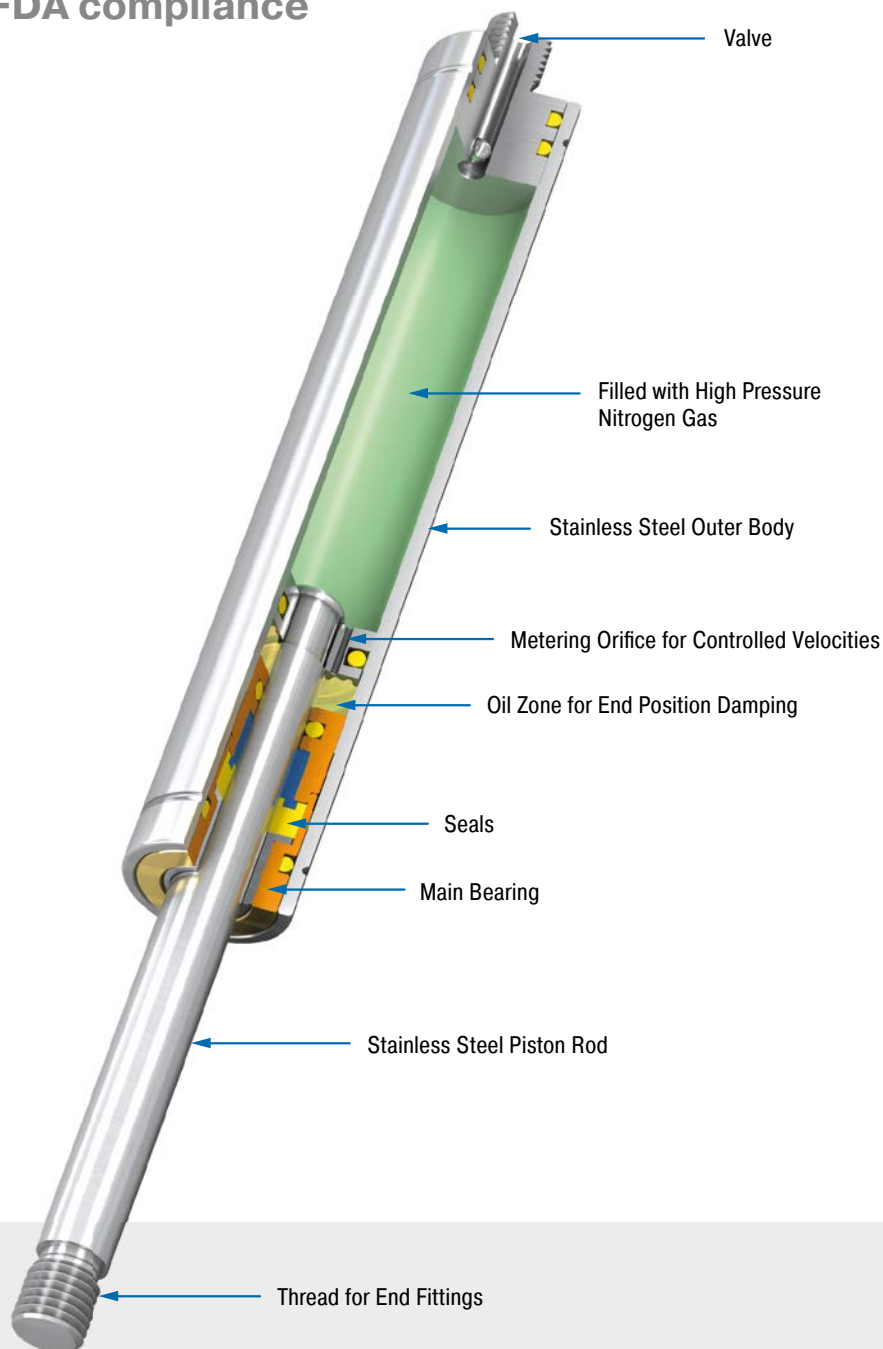

Technical Data

Extension force: 2 lbs to 1,124 lbs

Piston rod diameter: Ø 0.12 in to Ø 1.18 in

Progression: Approx. 13 % to 59 %
(depending on size and stroke)

Lifetime: Approx. 250,000 cycles

Operating temperature range: -4 °F to +176 °F

Material: Outer body, Piston rod, End fittings:
Stainless steel (1.4301/1.4305, AISI 304/303
and 1.4404/1.4571, AISI 316L/316Ti)

Operating fluid: Nitrogen gas and HLP oil
according to DIN 51524, part 2

Mounting: We recommend mounting with
piston rod downwards to take advantage of the
built-in end position damping.

End position damping length: Approx.
0.2 in to 1.18 in (depending on the stroke)

Positive stop: External positive stop at the
end of stroke provided by the customer.

Application field: Hoods, Shutters, Machine
housing, Conveyor systems, Control boxes,
Furniture industry, Shipbuilding, Food industry,
Pharmaceutical industry, Folding elements

Note: Special oil according to FDA 21 CFR
178.3570 of the food industry

End fittings: They are interchangeable and if
necessary must be positively secured by the
customer to prevent unscrewing.

Safety information: Gas pressure springs
should not be installed under pre-tension.

On request: Special oils and other special
options. Alternative accessories. Different end
position damping and extension speed. Other
gas springs material 1.4404/1.4571, AISI
316L/316Ti (V4A) available on request.

Valve Technology, Stainless Steel, Extension force 2 lbs to 22 lbs (compressed up to 29 lbs)

End Fitting

Standard Dimensions

End Fitting

B3.5 Stud Thread **B3.5**

A3.5-V4A Eye **A3.5-V4A**
max. force 83 lbs

C3.5-V4A Angle Ball Joint **C3.5-V4A**
max. force 83 lbs

D3.5-V4A Clevis Fork **D3.5-V4A**
max. force 83 lbs

G3.5-V4A Ball Socket **G3.5-V4A**
max. force 83 lbs

Adjuster Knob DE-GAS-3.5
See page 191.

| Performance and Dimensions | | | |
|----------------------------|----------------|--------------------|-----------------------------|
| TYPES | Stroke inch | L extended inch | Extension force max. lbs |
| GS-8-20-V4A | 0.79 | 2.83 | 22 |
| GS-8-30-V4A | 1.18 | 3.62 | 22 |
| GS-8-40-V4A | 1.57 | 4.41 | 22 |
| GS-8-50-V4A | 1.97 | 5.20 | 22 |
| GS-8-60-V4A | 2.36 | 5.98 | 22 |
| GS-8-80-V4A | 3.14 | 7.56 | 22 |

Ordering Example

GS-8-30-AC-30-V4A

Type (Push Type) _____
 Body 0.31" (8 mm) _____
 Stroke 1.18" (30 mm) _____
 Piston Rod End Fitting A3.5-V4A _____
 Body End Fitting C3.5-V4A _____
 Nominal Force F₁ 7 lbs (30 N) _____
 Material (1.4404/1.4571, AISI 316L/316Ti, V4A) _____

Mounting accessories see from page 220.

Technical Data

- Extension force:** 2 lbs to 22 lbs (compressed up to 29 lbs)
- Progression:** Approx. 28 % to 31 %
- Operating temperature range:** -4 °F to +176 °F
- Material:** Outer body, Piston rod, End fittings: Stainless steel (1.4404/1.4571, AISI 316L/316Ti)
- Mounting:** We recommend mounting with piston rod downwards to take advantage of the built-in end position damping.
- End position damping length:** approx. 0.2" (depending on the stroke)
- Positive stop:** External positive stop at the end of stroke provided by the customer.
- Note:** Special oil according to FDA 21 CFR 178.3570 of the food industry
- End fittings:** They are interchangeable and if necessary must be positively secured by the customer to prevent unscrewing.
- Safety information:** Gas pressure springs should not be installed under pre-tension.

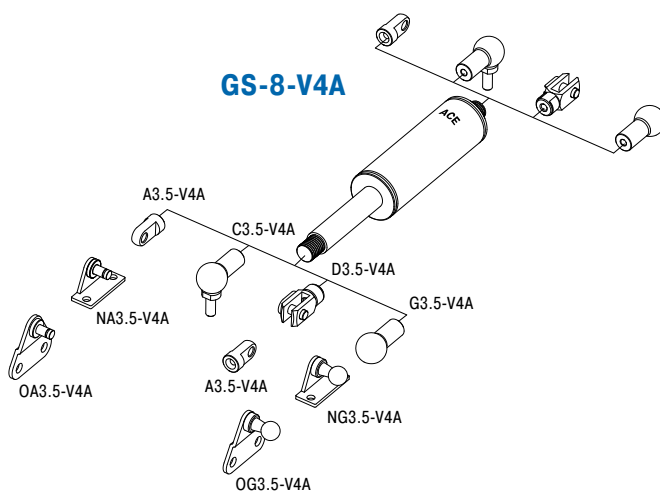

Valve Technology, Stainless Steel, Extension force 2 lbs to 22 lbs (compressed up to 26 lbs)

End Fitting

Standard Dimensions

End Fitting

B3.5 Stud Thread **B3.5**

A3.5-V4A Eye **A3.5-V4A**
max. force 83 lbs

C3.5-V4A Angle Ball Joint **C3.5-V4A**
max. force 83 lbs

D3.5-V4A Clevis Fork **D3.5-V4A**
max. force 83 lbs

G3.5-V4A Ball Socket **G3.5-V4A**
max. force 83 lbs

Adjuster Knob
DE-GAS-3.5
See page 191.

| Performance and Dimensions | | | |
|----------------------------|----------------|--------------------|-----------------------------|
| TYPES | Stroke inch | L extended inch | Extension force max. lbs |
| GS-10-20-V4A | 0.79 | 2.83 | 22 |
| GS-10-30-V4A | 1.18 | 3.62 | 22 |
| GS-10-40-V4A | 1.57 | 4.41 | 22 |
| GS-10-50-V4A | 1.97 | 5.20 | 22 |
| GS-10-60-V4A | 2.36 | 5.98 | 22 |
| GS-10-80-V4A | 3.14 | 7.56 | 22 |

Ordering Example
GS-10-30-AC-30-V4A
 Type (Push Type) _____
 Body 0.39" (10 mm) _____
 Stroke 1.18" (30 mm) _____
 Piston Rod End Fitting A3.5-V4A _____
 Body End Fitting C3.5-V4A _____
 Nominal Force F₁ 7 lbs (30 N) _____
 Material (1.4404/1.4571, AISI 316L/316Ti, V4A) _____

Mounting accessories see from page 220.

Technical Data

- Extension force:** 2 lbs to 22 lbs (compressed up to 26 lbs)
- Progression:** Approx. 13 % to 16 %
- Operating temperature range:** -4 °F to +176 °F
- Material:** Outer body, Piston rod, End fittings: Stainless steel (1.4404/1.4571, AISI 316L/316Ti)
- Mounting:** We recommend mounting with piston rod downwards to take advantage of the built-in end position damping.
- End position damping length:** approx. 0.2" (depending on the stroke)
- Positive stop:** External positive stop at the end of stroke provided by the customer.
- Note:** Special oil according to FDA 21 CFR 178.3570 of the food industry
- End fittings:** They are interchangeable and if necessary must be positively secured by the customer to prevent unscrewing.
- Safety information:** Gas pressure springs should not be installed under pre-tension.

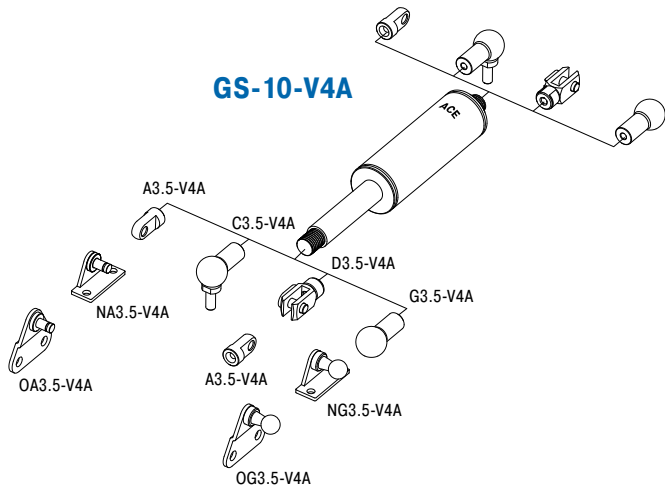

Valve Technology, Stainless Steel, Extension force 3 lbs to 40 lbs (compressed up to 51 lbs)

End Fitting

Standard Dimensions

End Fitting

B3.5

A3.5-V4A

C3.5-V4A

D3.5-V4A

G3.5-V4A

| Performance and Dimensions | | | |
|----------------------------|----------------|--------------------|-----------------------------|
| TYPES | Stroke inch | L extended inch | Extension force max. lbs |
| GS-12-20-V4A | 0.79 | 2.83 | 40 |
| GS-12-30-V4A | 1.18 | 3.62 | 40 |
| GS-12-40-V4A | 1.57 | 4.41 | 40 |
| GS-12-50-V4A | 1.97 | 5.20 | 40 |
| GS-12-60-V4A | 2.36 | 5.98 | 40 |
| GS-12-80-V4A | 3.14 | 7.56 | 34 |
| GS-12-100-V4A | 3.94 | 9.13 | 34 |
| GS-12-120-V4A | 4.72 | 10.71 | 27 |
| GS-12-150-V4A | 5.91 | 13.07 | 22 |

Ordering Example

GS-12-100-AA-30-V4A

Type (Push Type) _____

Body 0.47" (12 mm) _____

Stroke 3.94" (100 mm) _____

Piston Rod End Fitting A3.5-V4A _____

Body End Fitting A3.5-V4A _____

Nominal Force F₁ 7 lbs (30 N) _____

Material (1.4404/1.4571, AISI 316L/316Ti, V4A) _____

Mounting accessories see from page 220.

Stud Thread B3.5

Eye A3.5-V4A
max. force 83 lbs

Angle Ball Joint C3.5-V4A
max. force 83 lbs

Clevis Fork D3.5-V4A
max. force 83 lbs

Ball Socket G3.5-V4A
max. force 83 lbs

Adjuster Knob DE-GAS-3.5
See page 191.

Issue 04.2018 – Specifications subject to change

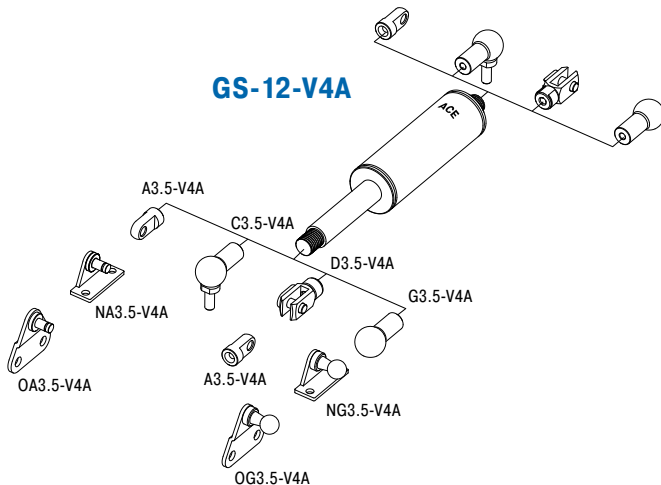

Technical Data

- Extension force:** 3 lbs to 40 lbs (compressed up to 51 lbs)
- Progression:** Approx. 20 % to 25 %
- Operating temperature range:** -4 °F to +176 °F
- Material:** Outer body, Piston rod, End fittings: Stainless steel (1.4404/1.4571, AISI 316L/316Ti)
- Mounting:** We recommend mounting with piston rod downwards to take advantage of the built-in end position damping.
- End position damping length:** approx. 0.39" (depending on the stroke)
- Positive stop:** External positive stop at the end of stroke provided by the customer.
- Note:** Special oil according to FDA 21 CFR 178.3570 of the food industry
- End fittings:** They are interchangeable and if necessary must be positively secured by the customer to prevent unscrewing.
- Safety information:** Gas pressure springs should not be installed under pre-tension.

Valve Technology, Stainless Steel, Extension force 9 lbs to 90 lbs (compressed up to 138 lbs)

End Fitting

Standard Dimensions

End Fitting

B5

A5-VA

C5-VA

D5-VA

E5-VA

G5-VA

Rod Shroud W5-15-VA

Performance and Dimensions

| TYPES | Stroke inch | L extended inch | Extension force max. lbs |
|--------------|----------------|--------------------|-----------------------------|
| GS-15-20-VA | 0.79 | 2.91 | 90 |
| GS-15-40-VA | 1.57 | 4.49 | 90 |
| GS-15-50-VA | 1.97 | 5.28 | 90 |
| GS-15-60-VA | 2.36 | 6.06 | 90 |
| GS-15-80-VA | 3.15 | 7.64 | 90 |
| GS-15-100-VA | 3.94 | 9.21 | 90 |
| GS-15-120-VA | 4.72 | 10.79 | 90 |
| GS-15-150-VA | 5.91 | 13.15 | 90 |

Ordering Example

GS-15-150-AC-150-VA

Type (Push Type) _____

Body 0.61" (15.6 mm) _____

Stroke 5.91" (150 mm) _____

Piston Rod End Fitting A5-VA _____

Body End Fitting C5-VA _____

Nominal Force F₁ 34 lbs (150 N) _____

Material (1.4301/1.4305, AISI 304/303, VA) _____

Stud Thread **B5**

Eye A5-VA
max. force 110 lbs

Angle Ball Joint C5-VA
max. force 97 lbs

Clevis Fork D5-VA
max. force 110 lbs

Swivel Eye E5-VA
max. force 110 lbs

Ball Socket G5-VA
max. force 97 lbs

Adjuster Knob DE-GAS-5
See page 191.

Mounting accessories see from page 220.

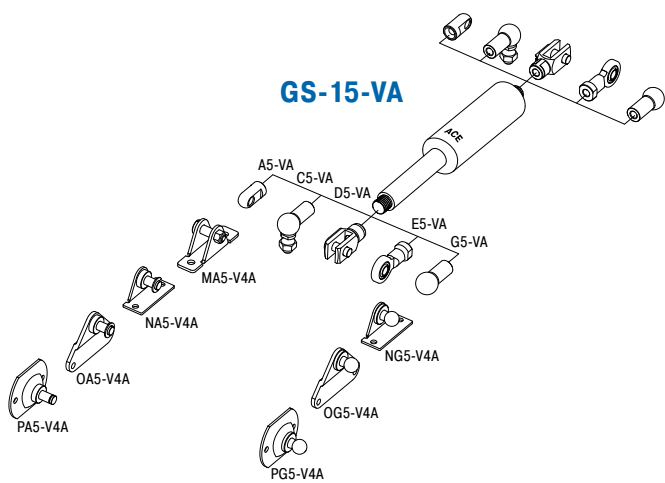

Technical Data

- Extension force:** 9 lbs to 90 lbs (compressed up to 138 lbs)
- Progression:** Approx. 30 % to 53 %
- Operating temperature range:** -4 °F to +176 °F
- Material:** Outer body, Piston rod, End fittings: Stainless steel (1.4301/1.4305, AISI 304/303)
- Mounting:** We recommend mounting with piston rod downwards to take advantage of the built-in end position damping.
- End position damping length:** approx. 0.79" (depending on the stroke)
- Positive stop:** External positive stop at the end of stroke provided by the customer.
- Note:** Special oil according to FDA 21 CFR 178.3570 of the food industry
- End fittings:** They are interchangeable and if necessary must be positively secured by the customer to prevent unscrewing.
- Safety information:** Gas pressure springs should not be installed under pre-tension.

Issue 04.2018 – Specifications subject to change

Valve Technology, Stainless Steel, Extension force 11 lbs to 157 lbs (compressed up to 208 lbs)

End Fitting

Standard Dimensions

End Fitting

B8

A8-VA

C8-VA

D8-VA

E8-VA

G8-VA

Rod Shroud W8-19-VA

Performance and Dimensions

| TYPES | Stroke inch | L extended inch | Extension force max. lbs |
|--------------|----------------|--------------------|-----------------------------|
| GS-19-50-VA | 1.97 | 6.46 | 157 |
| GS-19-100-VA | 3.94 | 10.39 | 157 |
| GS-19-150-VA | 5.91 | 14.33 | 157 |
| GS-19-200-VA | 7.87 | 18.27 | 157 |
| GS-19-250-VA | 9.84 | 22.20 | 135 |
| GS-19-300-VA | 11.81 | 26.14 | 101 |

Ordering Example

GS-19-150-AC-600-VA

Type (Push Type) _____

Body 0.75" (19 mm) _____

Stroke 5.91" (150 mm) _____

Piston Rod End Fitting A8-VA _____

Body End Fitting C8-VA _____

Nominal Force F₁ 135 lbs (600 N) _____

Material (1.4301/1.4305, AISI 304/303, VA) _____

Stud Thread B8

Eye A8-VA
max. force 351 lbs

Angle Ball Joint C8-VA
max. force 256 lbs

Clevis Fork D8-VA
max. force 351 lbs

Swivel Eye E8-VA
max. force 351 lbs

Ball Socket G8-VA
max. force 256 lbs

Adjuster Knob DE-GAS-8
See page 191.

Mounting accessories see from page 220.

Technical Data

- Extension force:** 11 lbs to 157 lbs (compressed up to 208 lbs)
- Progression:** Approx. 28 % to 32 %
- Operating temperature range:** -4 °F to +176 °F
- Material:** Outer body, Piston rod, End fittings: Stainless steel (1.4301/1.4305, AISI 304/303)
- Mounting:** We recommend mounting with piston rod downwards to take advantage of the built-in end position damping.
- End position damping length:** approx. 0.79" (depending on the stroke)
- Positive stop:** External positive stop at the end of stroke provided by the customer.
- Note:** Special oil according to FDA 21 CFR 178.3570 of the food industry
- End fittings:** They are interchangeable and if necessary must be positively secured by the customer to prevent unscrewing.
- Safety information:** Gas pressure springs should not be installed under pre-tension.

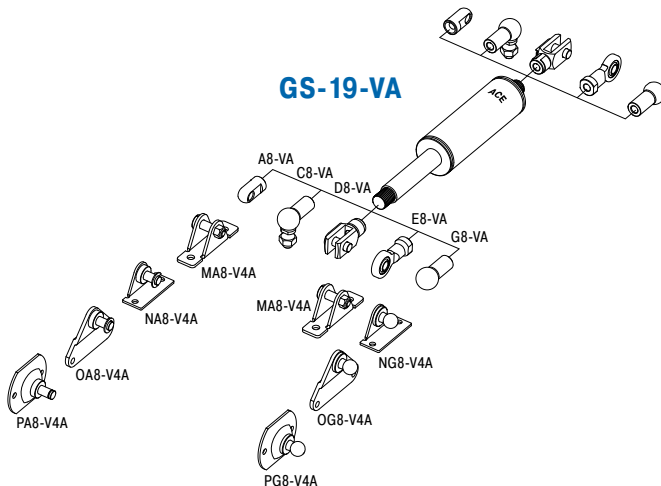

Valve Technology, Stainless Steel, Extension force 22 lbs to 270 lbs (compressed up to 359 lbs)

End Fitting

Standard Dimensions

End Fitting

B8 Stud Thread **B8**

A8-VA Eye **A8-VA** max. force 351 lbs

C8-VA Angle Ball Joint **C8-VA** max. force 256 lbs

D8-VA Clevis Fork **D8-VA** max. force 351 lbs

E8-VA Swivel Eye **E8-VA** max. force 351 lbs

G8-VA Ball Socket **G8-VA** max. force 256 lbs

W8-22-VA Rod Shroud

Adjuster Knob DE-GAS-8 See page 191.

| Performance and Dimensions | | | |
|----------------------------|----------------|--------------------|-----------------------------|
| TYPES | Stroke inch | L extended inch | Extension force max. lbs |
| GS-22-50-VA | 1.97 | 6.46 | 270 |
| GS-22-100-VA | 3.94 | 10.39 | 270 |
| GS-22-150-VA | 5.91 | 14.33 | 270 |
| GS-22-200-VA | 7.87 | 18.28 | 270 |
| GS-22-250-VA | 9.84 | 22.20 | 270 |
| GS-22-300-VA | 11.81 | 26.14 | 247 |
| GS-22-350-VA | 13.78 | 30.08 | 191 |
| GS-22-400-VA | 15.75 | 34.02 | 146 |
| GS-22-450-VA | 17.72 | 37.95 | 124 |
| GS-22-500-VA | 19.69 | 41.89 | 101 |
| GS-22-550-VA | 21.65 | 45.83 | 90 |
| GS-22-600-VA | 23.62 | 49.76 | 79 |
| GS-22-650-VA | 25.59 | 53.70 | 67 |
| GS-22-700-VA | 27.56 | 57.64 | 56 |

Ordering Example

GS-22-150-AE-800-VA

Type (Push Type) _____
 Body 0.91" (23 mm) _____
 Stroke 5.91" (150 mm) _____
 Piston Rod End Fitting A8-VA _____
 Body End Fitting E8-VA _____
 Nominal Force F₁ 180 lbs (800 N) _____
 Material (1.4301/1.4305, AISI 304/303, VA) _____

Mounting accessories see from page 220.

Technical Data

Extension force: 22 lbs to 270 lbs (compressed up to 359 lbs)

Progression: Approx. 29 % to 33 %

Operating temperature range: -4 °F to +176 °F

Material: Outer body, Piston rod, End fittings: Stainless steel (1.4301/1.4305, AISI 304/303)

Mounting: We recommend mounting with piston rod downwards to take advantage of the built-in end position damping.

End position damping length: approx. 0.79" (depending on the stroke)

Positive stop: External positive stop at the end of stroke provided by the customer.

Note: Special oil according to FDA 21 CFR 178.3570 of the food industry

End fittings: They are interchangeable and if necessary must be positively secured by the customer to prevent unscrewing.

Safety information: Gas pressure springs should not be installed under pre-tension.

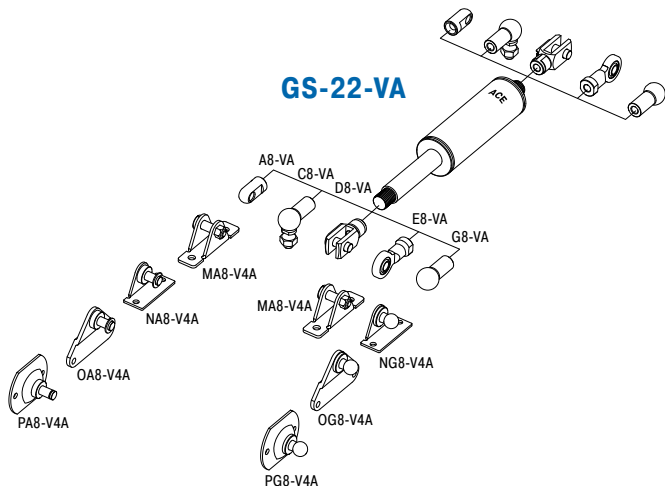

Valve Technology, Stainless Steel, Extension force 34 lbs to 562 lbs (compressed up to 894 lbs)

End Fitting

Standard Dimensions

End Fitting

B10

M10x1.5

Ø.55

Stroke

L +/- 0.08 extended

Ø.110

.47

Performance and Dimensions

| TYPES | Stroke inch | L extended inch | Extension force max. lbs |
|--------------|----------------|--------------------|-----------------------------|
| GS-28-100-VA | 3.94 | 10.31 | 562 |
| GS-28-150-VA | 5.91 | 14.25 | 562 |
| GS-28-200-VA | 7.87 | 18.19 | 562 |
| GS-28-250-VA | 9.84 | 22.13 | 562 |
| GS-28-300-VA | 11.81 | 26.06 | 562 |
| GS-28-350-VA | 13.78 | 30.00 | 562 |
| GS-28-400-VA | 15.75 | 33.94 | 540 |
| GS-28-450-VA | 17.72 | 37.87 | 438 |
| GS-28-500-VA | 19.69 | 41.81 | 360 |
| GS-28-550-VA | 21.65 | 45.75 | 303 |
| GS-28-600-VA | 23.62 | 49.69 | 259 |
| GS-28-650-VA | 25.59 | 53.62 | 225 |

Ordering Example

GS-28-150-EE-1200-VA

Type (Push Type) _____

Body 1.1" (28 mm) _____

Stroke 5.91" (150 mm) _____

Piston Rod End Fitting E10-VA _____

Body End Fitting E10-VA _____

Nominal Force F₁ 270 lbs (1,200 N) _____

Material (1.4301/1.4305, AISI 304/303, VA) _____

Stud Thread B10

Eye A10-VA
max. force 854 lbs

Angle Ball Joint C10-VA
max. force 393 lbs

Clevis Fork D10-VA
max. force 854 lbs

Swivel Eye E10-VA
max. force 854 lbs

Adjuster Knob DE-GAS-10
See page 191.

A10-VA

Radius R0.35

Ø.71

.32

.59

.59

1.06

Mounting accessories see from page 220.

Eye A10-VA
max. force 854 lbs

Angle Ball Joint C10-VA
max. force 393 lbs

Clevis Fork D10-VA
max. force 854 lbs

Swivel Eye E10-VA
max. force 854 lbs

Adjuster Knob DE-GAS-10
See page 191.

C10-VA

Ø.94

Ø.63

.63

.71

.79

1.38

M10x1.5

36°

Mounting accessories see from page 220.

Angle Ball Joint C10-VA
max. force 393 lbs

Clevis Fork D10-VA
max. force 854 lbs

Swivel Eye E10-VA
max. force 854 lbs

Adjuster Knob DE-GAS-10
See page 191.

D10-VA

Ø.39

1.04

.79

.39

.79

.47

1.57

Mounting accessories see from page 220.

Clevis Fork D10-VA
max. force 854 lbs

Swivel Eye E10-VA
max. force 854 lbs

Adjuster Knob DE-GAS-10
See page 191.

E10-VA

24°

Ø.39

.28

Ø.59

Ø.75

.55

.63

1.69

.71

.55

Mounting accessories see from page 220.

Swivel Eye E10-VA
max. force 854 lbs

Adjuster Knob DE-GAS-10
See page 191.

Rod Shroud W10-28-VA

Ø 1.26

L = Stroke + 1.57

Mounting accessories see from page 220.

Adjuster Knob DE-GAS-10
See page 191.

Issue 04.2018 – Specifications subject to change

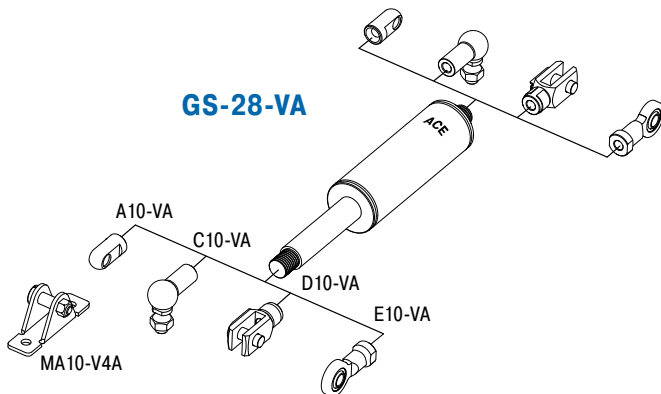

Technical Data

- Extension force:** 34 lbs to 562 lbs (compressed up to 894 lbs)
- Progression:** Approx. 53 % to 59 %
- Operating temperature range:** -4 °F to +176 °F
- Material:** Outer body, Piston rod, End fittings: Stainless steel (1.4301/1.4305, AISI 304/303)
- Mounting:** We recommend mounting with piston rod downwards to take advantage of the built-in end position damping.
- End position damping length:** approx. 0.79" (depending on the stroke)
- Positive stop:** External positive stop at the end of stroke provided by the customer.
- Note:** Special oil according to FDA 21 CFR 178.3570 of the food industry
- End fittings:** They are interchangeable and if necessary must be positively secured by the customer to prevent unscrewing.
- Safety information:** Gas pressure springs should not be installed under pre-tension.

Valve Technology, Stainless Steel, Extension force 112 lbs to 1,124 lbs (compressed up to 1,596 lbs)

End Fitting

Standard Dimensions

End Fitting

B14

A14-VA

C14-VA

D14-VA

E14-VA

Rod Shroud W14-40-VA

Performance and Dimensions

| TYPES | Stroke inch | L extended inch | Extension force max. lbs |
|--------------|----------------|--------------------|-----------------------------|
| GS-40-100-VA | 3.94 | 12.48 | 1,124 |
| GS-40-150-VA | 5.91 | 16.42 | 1,124 |
| GS-40-200-VA | 7.87 | 20.35 | 1,124 |
| GS-40-300-VA | 11.81 | 28.23 | 1,124 |
| GS-40-400-VA | 15.75 | 36.10 | 1,124 |
| GS-40-500-VA | 19.69 | 43.98 | 1,124 |
| GS-40-600-VA | 23.62 | 51.85 | 933 |

Ordering Example

GS-40-150-DD-3500-VA

Type (Push Type) _____

Body 1.57" (40 mm) _____

Stroke 5.91" (150 mm) _____

Piston Rod End Fitting D14-VA _____

Body End Fitting D14-VA _____

Nominal Force F₁ 787 lbs (3,500 N) _____

Material (1.4301/1.4305, AISI 304/303, VA) _____

Stud Thread B14

Eye A14-VA
max. force 1,574 lbs

Angle Ball Joint C14-VA
max. force 719 lbs

Clevis Fork D14-VA
max. force 1,574 lbs

Swivel Eye E14-VA
max. force 1,574 lbs

Adjuster Knob DE-GAS-14
See page 191.

Mounting accessories see from page 220.

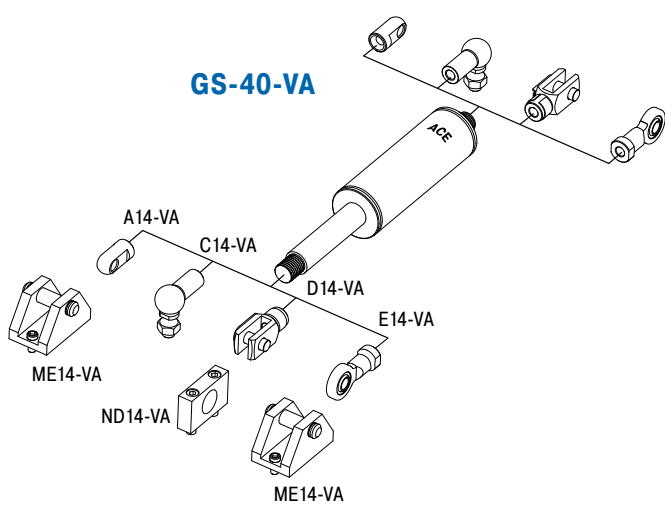

Technical Data

- Extension force:** 112 lbs to 1,124 lbs (compressed up to 1,596 lbs)
- Progression:** Approx. 34 % to 42 %
- Operating temperature range:** -4 °F to +176 °F
- Material:** Outer body, Piston rod, End fittings: Stainless steel (1.4301/1.4305, AISI 304/303)
- Mounting:** We recommend mounting with piston rod downwards to take advantage of the built-in end position damping.
- End position damping length:** approx. 1.18" (depending on the stroke)
- Positive stop:** External positive stop at the end of stroke provided by the customer.
- Note:** Special oil according to FDA 21 CFR 178.3570 of the food industry
- End fittings:** They are interchangeable and if necessary must be positively secured by the customer to prevent unscrewing.
- Safety information:** Gas pressure springs should not be installed under pre-tension.

Issue 04.2018 – Specifications subject to change

Stainless Steel Gas Springs (Push Type), V4A

| TYPES | Stroke inch | L extended inch | Dimensions see page |
|---------------|----------------|--------------------|------------------------|
| GS-15-20-V4A | 0.79 | 2.91 | 164 |
| GS-15-40-V4A | 1.57 | 4.49 | 164 |
| GS-15-50-V4A | 1.97 | 5.28 | 164 |
| GS-15-60-V4A | 2.36 | 6.06 | 164 |
| GS-15-80-V4A | 3.15 | 7.64 | 164 |
| GS-15-100-V4A | 3.94 | 9.21 | 164 |
| GS-15-120-V4A | 4.72 | 10.79 | 164 |
| GS-15-150-V4A | 5.91 | 13.15 | 164 |
| GS-19-50-V4A | 1.97 | 6.46 | 165 |
| GS-19-100-V4A | 3.94 | 10.39 | 165 |
| GS-19-150-V4A | 5.91 | 14.33 | 165 |
| GS-19-200-V4A | 7.87 | 18.27 | 165 |
| GS-19-250-V4A | 9.84 | 22.20 | 165 |
| GS-19-300-V4A | 11.81 | 26.14 | 165 |
| GS-22-50-V4A | 1.97 | 6.46 | 166 |
| GS-22-100-V4A | 3.94 | 10.39 | 166 |
| GS-22-150-V4A | 5.91 | 14.33 | 166 |
| GS-22-200-V4A | 7.87 | 18.28 | 166 |
| GS-22-250-V4A | 9.84 | 22.20 | 166 |
| GS-22-300-V4A | 11.81 | 26.14 | 166 |
| GS-22-350-V4A | 13.78 | 30.08 | 166 |
| GS-22-400-V4A | 15.75 | 34.02 | 166 |
| GS-22-450-V4A | 17.72 | 37.95 | 166 |
| GS-22-500-V4A | 19.69 | 41.89 | 166 |
| GS-22-550-V4A | 21.65 | 45.83 | 166 |
| GS-22-600-V4A | 23.62 | 49.76 | 166 |
| GS-22-650-V4A | 25.59 | 53.70 | 166 |
| GS-22-700-V4A | 27.56 | 57.64 | 166 |
| GS-28-100-V4A | 3.94 | 10.31 | 167 |
| GS-28-150-V4A | 5.91 | 14.25 | 167 |
| GS-28-200-V4A | 7.87 | 18.19 | 167 |
| GS-28-250-V4A | 9.84 | 22.13 | 167 |
| GS-28-300-V4A | 11.81 | 26.06 | 167 |
| GS-28-350-V4A | 13.78 | 30.00 | 167 |
| GS-28-400-V4A | 15.75 | 33.94 | 167 |
| GS-28-450-V4A | 17.72 | 37.87 | 167 |
| GS-28-500-V4A | 19.69 | 41.81 | 167 |
| GS-28-550-V4A | 21.65 | 45.75 | 167 |
| GS-28-600-V4A | 23.62 | 49.69 | 167 |
| GS-28-650-V4A | 25.59 | 53.62 | 167 |
| GS-40-100-V4A | 3.94 | 12.48 | 168 |
| GS-40-150-V4A | 5.91 | 16.42 | 168 |
| GS-40-200-V4A | 7.87 | 20.35 | 168 |
| GS-40-300-V4A | 11.81 | 28.23 | 168 |
| GS-40-400-V4A | 15.75 | 36.10 | 168 |
| GS-40-500-V4A | 19.69 | 43.98 | 168 |
| GS-40-600-V4A | 23.62 | 51.85 | 168 |

Stainless Steel Accessories, V4A

| TYPES | Dimensions see page |
|---------|------------------------|
| A5-V4A | 222 |
| C5-V4A | 222 |
| D5-V4A | 222 |
| E5-V4A | 222 |
| G5-V4A | 222 |
| A8-V4A | 223 |
| C8-V4A | 223 |
| D8-V4A | 223 |
| E8-V4A | 223 |
| G8-V4A | 224 |
| A10-V4A | 224 |
| C10-V4A | 224 |
| D10-V4A | 224 |
| E10-V4A | 224 |
| A14-V4A | 225 |
| C14-V4A | 225 |
| D14-V4A | 225 |
| E14-V4A | 225 |

GST-40 Tandem

Optimized dual force for heavy flaps and wide angle applications

Valve Technology

Extension force 67 lbs to 1,124 lbs

Stroke 1.97 in to 15.75 in

Cover two differing force ranges: Tandem gas springs by ACE are maintenance-free and ready-to-install. Two pressure tubes deliver different extension forces and progression curves. With this type of gas spring you cover the different force ranges between the start and end of an application. ACE provides free specification support to deliver a gas spring that meets your specific application needs. We manufacture and adjust precisely to the required dynamics of the application.

A comprehensive range of accessories guarantees easy assembly and a broad range of uses, are specifically suitable for heavy loads with large opening angle. Stainless steel versions are available to meet environmental or appearance requirements.

Tandem push type gas springs from ACE are used in industrial applications such as in automation and machine building, in the automobile, electronics and furniture industries, but also in medical technology as well as for service hatches.

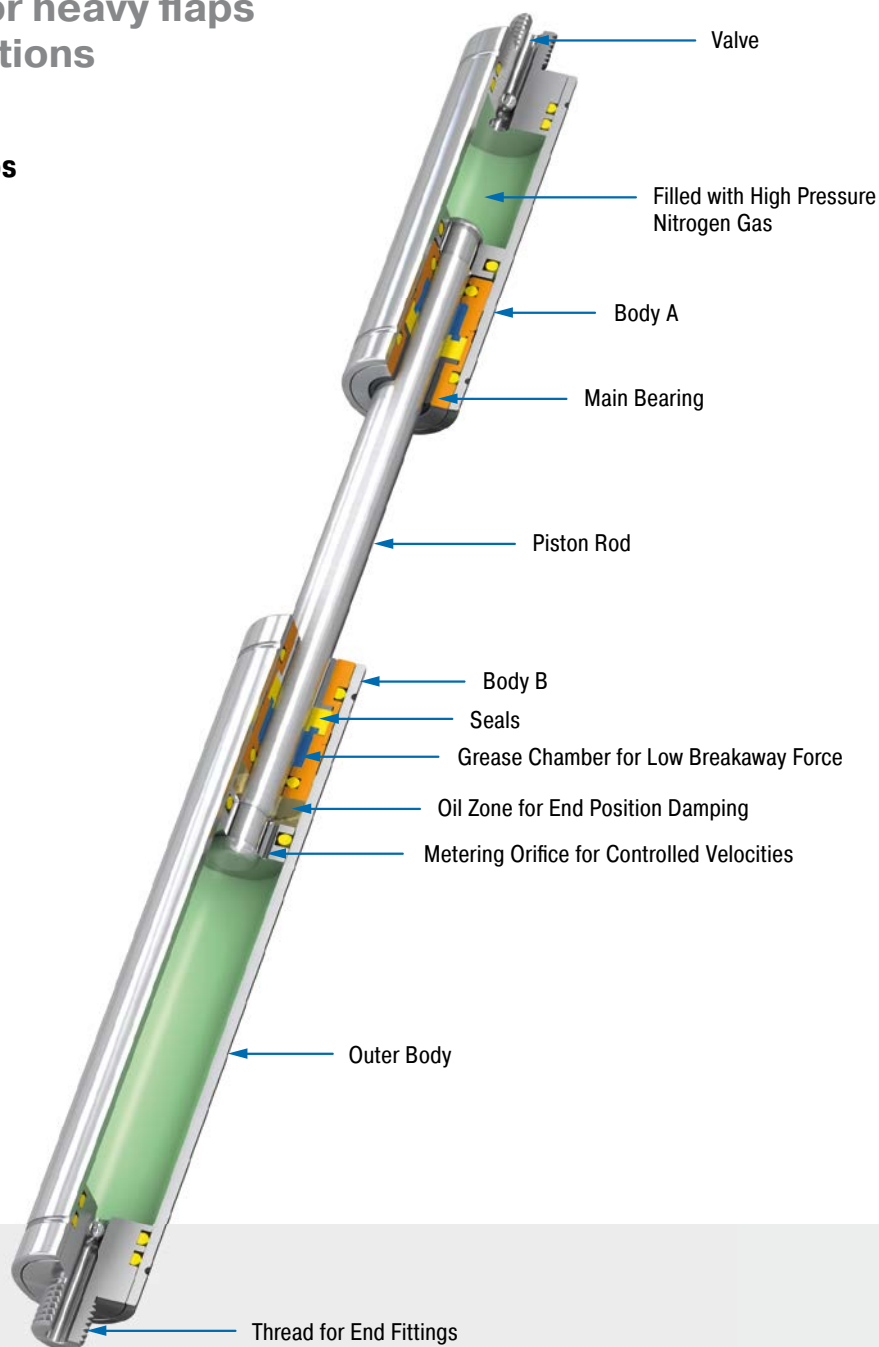

Technical Data

Extension force: 67 lbs to 1,124 lbs

Piston rod diameter: Ø 0.79 in

Progression: According to calculation relating to your application.

Lifetime: Approx. 250,000 cycles

Operating temperature range: -4 °F to +176 °F

Material: Outer body, End fittings: Zinc plated steel; Piston rod: Steel with wear-resistant coating

Operating fluid: Nitrogen gas and oil

Mounting: In any position. Please adopt the mounting points determined by ACE.

End position damping length: Application-specific end position damping and extension speed.

Positive stop: External positive stop at the end of stroke provided by the customer.

Application field: Hoods, Shutters, Machine housing, Conveyor systems, Folding elements, Loading and lifting equipment

Note: These gas springs are tailored to the relevant application and are therefore not available ex stock.

End fittings: They are interchangeable and if necessary must be positively secured by the customer to prevent unscrewing.

On request: Special oils and other special options. Alternative accessories. Material 1.4301/1.4305, AISI 304/303 (V2A) and 1.4404/1.4571, AISI 316L/316Ti (V4A).

End Fitting

Standard Dimensions

End Fitting

A14

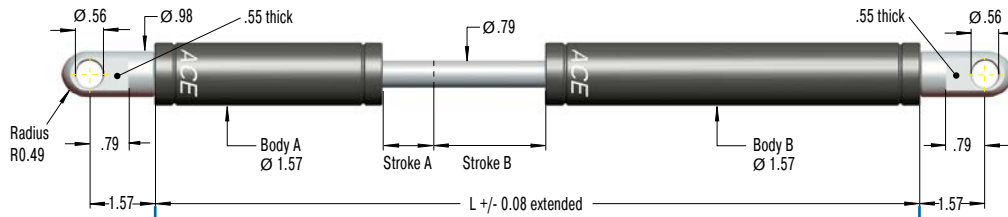

Eye A14
max. force 2,248 lbs

B14

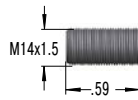

Performance and Dimensions

| TYPES | Stroke A inch | Stroke B inch | L extended inch | Extension force max. lbs |
|---------------|------------------|------------------|--------------------|-----------------------------|
| GST-40-50-100 | 1.97 | 3.94 | 10.09 | 1,124 |
| GST-40-50-150 | 1.97 | 5.91 | 23.03 | 1,124 |
| GST-40-50-200 | 1.97 | 7.87 | 26.97 | 1,124 |
| GST-40-70-250 | 2.76 | 9.84 | 32.48 | 1,124 |
| GST-40-70-300 | 2.76 | 11.81 | 36.42 | 1,124 |
| GST-40-70-350 | 2.76 | 13.78 | 40.35 | 1,124 |
| GST-40-70-400 | 2.76 | 15.75 | 40.35 | 1,124 |

Stud Thread B14

D14

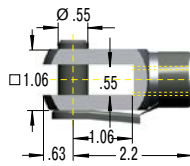

Clevis Fork D14
max. force 2,248 lbs

E14

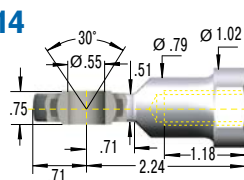

Swivel Eye E14
max. force 2,248 lbs

Ordering Example

GST-40-50-150-AD-900N-2500N

- Type (Tandem Gas Spring) _____
- Body 1.57" (40 mm) _____
- Stroke A 1.97" (50 mm) _____
- Stroke B 5.91" (150 mm) _____
- Body A End Fitting, A14 _____
- Body B End Fitting, D14 _____
- Nominal Force Body A, 202 lbs (900 N) _____
- Nominal Force Body B, 562 lbs (2,500 N) _____

Mounting accessories see from page 212.

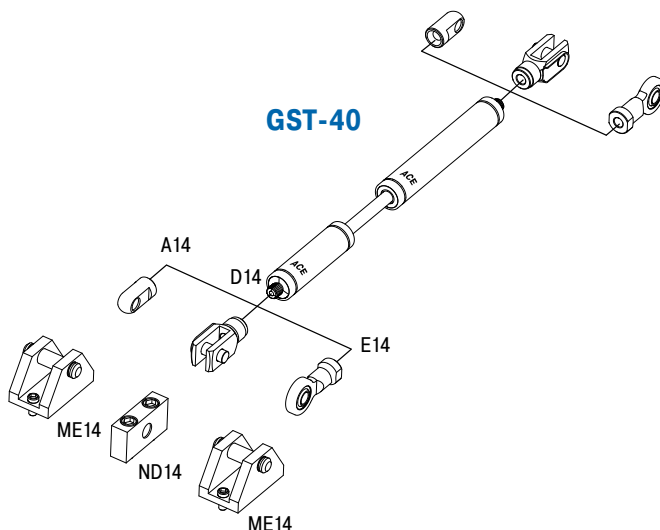

Technical Data

- Extension force:** 67 lbs to 1,124 lbs
- Progression:** According to calculation relating to your application.
- Operating temperature range:** -4 °F to +176 °F
- Material:** Outer body, End fittings: Zinc plated steel; Piston rod: Steel with wear-resistant coating
- Mounting:** In any position. Please adopt the mounting points determined by ACE.
- End position damping length:** Application-specific end position damping and extension speed.
- Positive stop:** External positive stop at the end of stroke provided by the customer.
- Note:** These gas springs are tailored to the relevant application and are therefore not available ex stock.
- End fittings:** They are interchangeable and if necessary must be positively secured by the customer to prevent unscrewing.

Application Examples

GS-12

Safe opening and closing

ACE industrial gas springs (push type) protect samples in an incubator, which is used for chemical and biochemical applications. The plexiglass hood, under which may be found valuable laboratory goods, is securely held open by two maintenance-free, ready-to-install ACE industrial gas springs (push type) of the type GS-12-60-AA-X. With an end-position damping of 0.20 in and an extension force of 2.25 to 40.5 lbs, they help to handle the forces generated. The hood is always easily opened and remains in this position. It also remains securely shut when the incubator is in operation.



Very small ACE industrial gas springs (push type) enable careful opening and closing movements of a mini-incubator hood, under which may be found laboratory products

GFL Gesellschaft für Labortechnik mbH, 30938 Burgwedel, Germany

GS-19

Doors open and close safely

ACE industrial gas springs make opening and closing doors of rescue helicopters easier. The maintenance-free, sealed systems are installed in the access doors of helicopters of the EC 135. There, they allow the crew to enter or exit the helicopter quickly, thus contributing to enhanced safety. The GS-19-300 gas springs provide a defined retraction speed and secure engagement of the door lock. The integrated end position damper allows gentle closing of the door and saves wear and tear on the valuable, lightweight material.

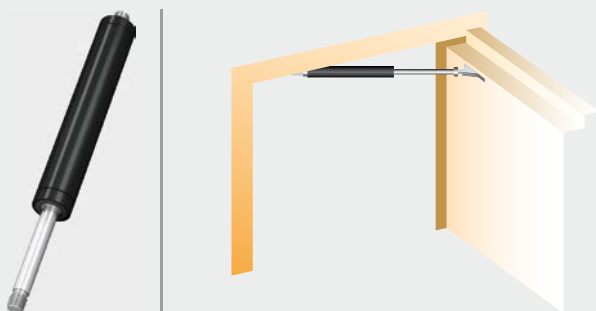

Industrial gas springs: For safe entry and exit

GS-22-VA

Made-to-measure stainless steel gas springs

A special hygiene and toilet chair, designed for children and young people with disabilities, must be firmly lockable in the sit and tilt positions. The practical aid thereby provided for relatives and carers can be attributed to two lockable ACE industrial gas springs (push type) which were especially developed and manufactured for this application and operate on the basis of the so-called tilt-in-space function. This allows the chair to be tilted forwards and backwards and provides significantly more convenience for users and patients. In order to meet all hygiene requirements, the gas springs are constructed in stainless steel.

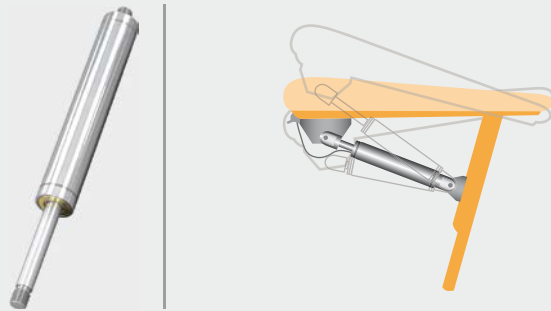

With inclination angles of 15 degrees to the front and rear, the ACE stainless steel gas springs facilitate the work of nurses
Rifton Equipment, Rifton, New York 12471, USA

GST-40

Tandemly-operated large flaps securely under control

Underground distribution systems are visually advantageous. To facilitate their servicing, the heavy covers of the often large supply systems are brought back to the surface with the help of ACE industrial tandem gas springs (push type). This is quite easily achieved thanks to the use of two pressure pipes, the result of which is two different force ranges. This means fitters must not endure laborious bending and a downward passage into the system of channels. In addition to these advantages, the springs benefit from their long service life and their capacity to be used, as stainless steel variants, in even the most hygienically-sensitive areas.

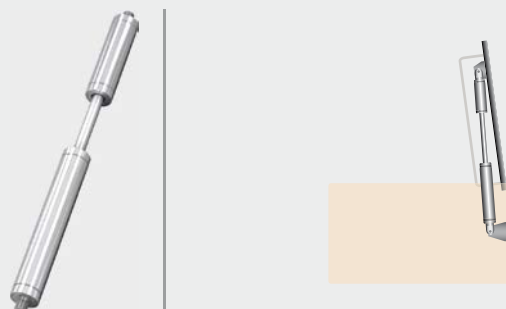

ACE industrial tandem gas springs (push type) enable easy maintenance of supply boxes by making the heavy flaps easier to operate
Langmatz GmbH, 82467 Garmisch-Partenkirchen, Germany

Issue 04.2018 – Specifications subject to change

Industrial Gas Springs – Pull Type

Alternatives for tight spaces and mounting requirements

If ACE gas push type springs cannot be used due to a lack of space, ACE's industrial gas pull type springs come into their own. These compact assistants with body diameters of 0.59" to 1.57" (15 to 40 mm) are effective in the direction of traction and work in the opposite way to the principle of gas push type springs.

This means that the gas pressure in the cylinder draws the piston rod in and, when closing a flap for example, supports the manual force required for a controlled motion. ACE's gas pull type springs are also self-contained, maintenance-free machine elements and equipped with a standard valve to individually regulate the gas pressure, whereby they cover forces between 7 to 1125 lbf (30 and 5,000 N). The ability to mount in any orientation and position along with an extensive range of DIN standardized accessories enable universal use.

Compact design

Individual filling valve technology

Calculation program for specific design

Universally applicable



Function of a Gas Spring – Pull Type

Gas pull type springs work based on the reverse principle of a gas push type spring. They are also individually filled according to customer request to a certain pressure (extension force F_1). However, the piston rod here is pulled inwards by the gas pressure in the cylinder. The higher the pressure, the greater the traction force.

The piston ring surface between the piston rod and the inner tube is decisive for the function. When the piston rod pulls out, the nitrogen from the piston is compressed in the inner tube. The force increase (progression) of the gas spring is due to the rising pressure. The force increase is almost linear.

Calculation Principles

Force-Stroke Characteristics of Traction Gas Spring (Pull Type)

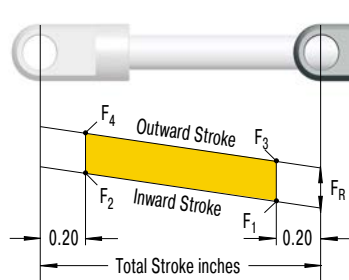

- F_1 = nominal force at 68 °F (this is the pressure figure normally used when specifying the gas spring)
- F_2 = force in the complete extended position
- When extending the piston rod, there is an additional friction force caused by the contact pressure of the seals (this **only** occurs **during the extension stroke**):
- F_3 = force at the beginning of the extension stroke
- F_4 = force at the end of the extension stroke

Free calculation service see page 188!

Gas Springs (Pull Type)

| TYPES | Progression approx. % | ¹ Friction F_R approx. in lbs |
|-------|-----------------------|--|
| GZ-15 | 12 - 22 ² | 12.36 - 31.47 |
| GZ-19 | 21 - 28 ² | 4.50 - 8.99 |
| GZ-28 | 28 - 30 ² | 22.48 - 44.96 |
| GZ-40 | 43 - 45 ² | |

¹ Depending on the filling force
² Depending on the stroke

Progression: (the slope of the force line in the diagram above) is due to the reduction of the internal gas volume as the piston rod moves from its initial position to its fully stroked position. The approx. progression values given above for standard springs can be altered on request.

Effect of temperature: The nominal F_1 figure is given at 68 °F. An increase of 50 °F will increase force by 3.4 %.

Filling tolerances: -4.50 lbs to +8.99 lbs or 5 % to 7 %. Depending on size and extension force the tolerances can differ.

Industrial Gas Springs – Pull Type



GZ-15 to GZ-40

Valve Technology
Very low progression rate
 Hoods, Shutters, Machine housing, Conveyor systems

Page 176

GZ-15-V4A to GZ-40-VA

Valve Technology, Stainless Steel
Very low progression rate with FDA approval
 Hoods, Shutters, Machine housing, Conveyor systems

Page 182

GZ-15 to GZ-40

Very low progression rate

Valve Technology

Traction force 9 lbs to 1,124 lbs

Stroke 0.79 in to 25.59 in

The solution to a lack of space: If standard push type gas springs cannot be used due to a lack of space, ACE's industrial pull type gas springs are the solution. They work in the opposite way of standard push type gas springs. The piston rod is retracted when the cylinder is unloaded. The gas pressure in the cylinder draws the piston rod in.

ACE pull type gas springs offer the maximum service life thanks to the solid chrome-plated piston rod and an integrated sliding bearing. The maintenance-free and ready-to-install products are available in body diameters of 0.59" to 1.57" (15 to 40 mm) as well as forces from 8.99 lbs to 1,124 lbs. (40 to 5,000 N) and are available from stock with valve and a large selection of accessories. The traction force can be fine-tuned using the adjustment valve.

Gas traction springs from ACE are used in industrial applications, automation and machine building, especially in test equipment and in medical technology as well as in the electronics and furniture industries.

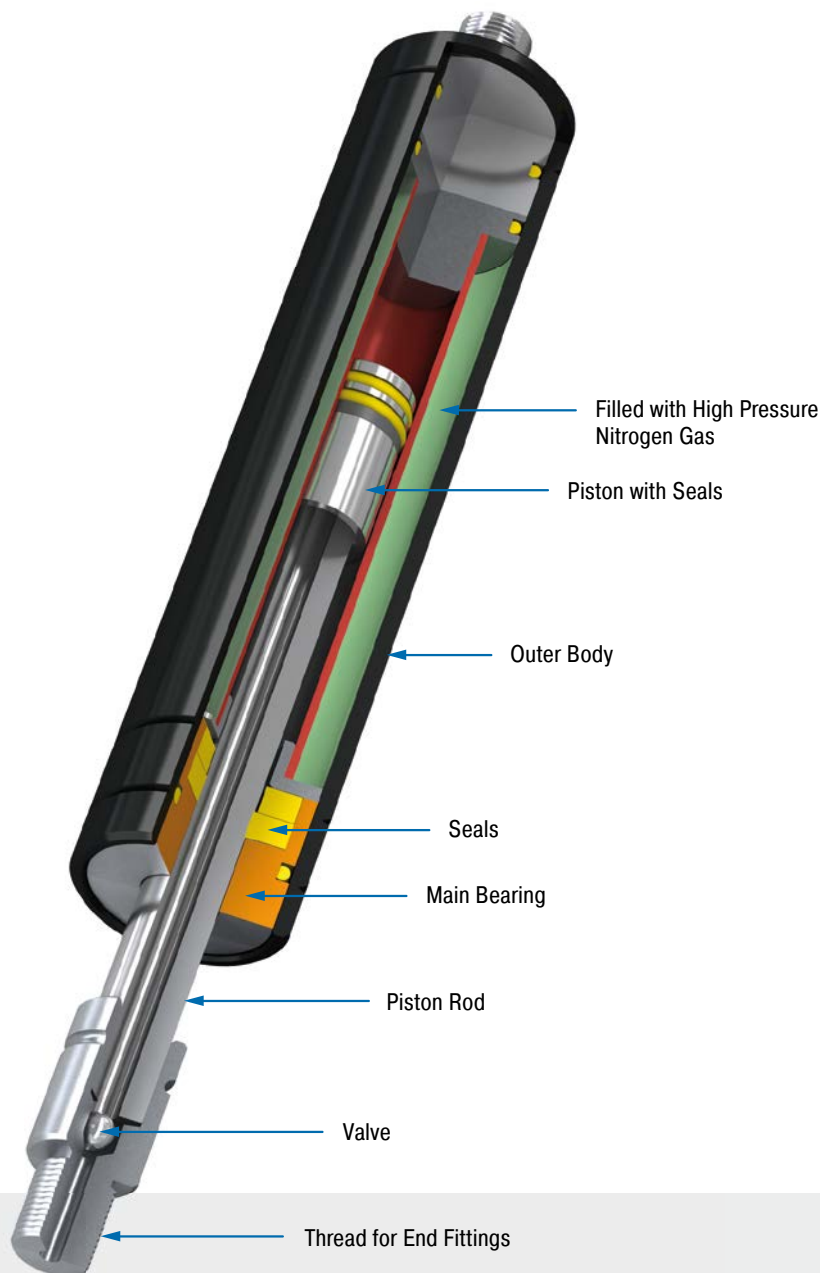

Technical Data

Traction force: 9 lbs to 1,124 lbs

Piston rod diameter: Ø 0.16 in to Ø 1.10 in

Progression: Approx. 12 % to 45 %

Lifetime: Approx. 6,561 ft

Operating temperature range: -4 °F to +176 °F

Material: Outer body, End fittings: Zinc plated steel; Piston rod: Steel or stainless steel with wear-resistant coating

Operating fluid: Nitrogen gas

Mounting: With piston rod upwards.

End position damping length: Without damping. For end position damping use damping material (e.g. TUBUS or SLAB).

Positive stop: External positive stop at the end of stroke provided by the customer.

Application field: Hoods, Shutters, Machine housing, Conveyor systems, Control boxes, Furniture industry, Shipbuilding, Assembly stations, Vehicle technology, Folding elements

End fittings: They are interchangeable and if necessary must be positively secured by the customer to prevent unscrewing.

On request: Special oils and other special options. Alternative accessories. Traction gas springs with end position damping also available on request.

Valve Technology, Traction force 11 lbs to 34 lbs (extended up to 41 lbs)

End Fitting

Standard Dimensions

End Fitting

A3.5

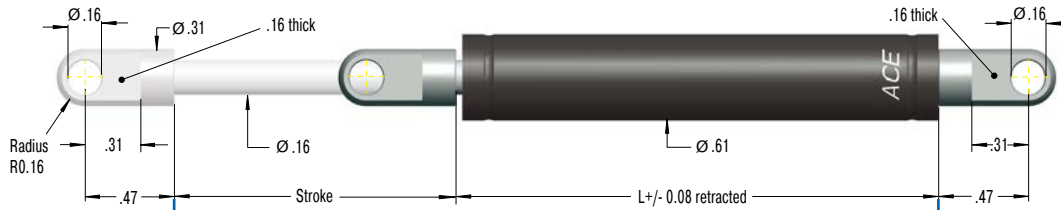

Eye A3.5
max. force 83 lbs

B3.5



Stud Thread B3.5

C3.5

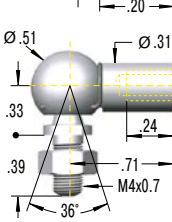

Angle Ball Joint C3.5
max. force 83 lbs

D3.5

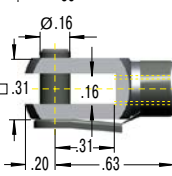

Clevis Fork D3.5
max. force 83 lbs

E3.5

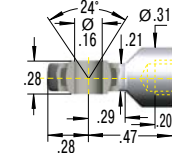

Swivel Eye E3.5
max. force 83 lbs

G3.5

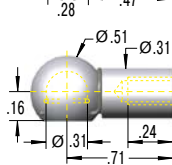

Ball Socket G3.5
max. force 83 lbs

Performance and Dimensions

| TYPES | Stroke inch | L retracted inch | Traction force max. lbs |
|-----------|----------------|---------------------|----------------------------|
| GZ-15-20 | 0.79 | 3.43 | 34 |
| GZ-15-40 | 1.57 | 4.21 | 34 |
| GZ-15-50 | 1.97 | 4.61 | 34 |
| GZ-15-60 | 2.36 | 5.00 | 34 |
| GZ-15-80 | 3.15 | 5.79 | 34 |
| GZ-15-100 | 3.94 | 6.57 | 34 |
| GZ-15-120 | 4.72 | 7.36 | 34 |
| GZ-15-150 | 5.91 | 8.54 | 34 |

Ordering Example

GZ-15-150-AC-V-150

Type (Pull Type) _____
 Body 0.61" (15.6 mm) _____
 Stroke 5.91" (150 mm) _____
 Piston Rod End Fitting A3.5 _____
 Body End Fitting C3.5 _____
 Adjustable (V) _____
 Traction Force F₁ 34 lbs (150 N) _____

Mounting accessories see from page 212.

Adjuster Knob
DE-GAS-3.5

See page 191.

GZ-15

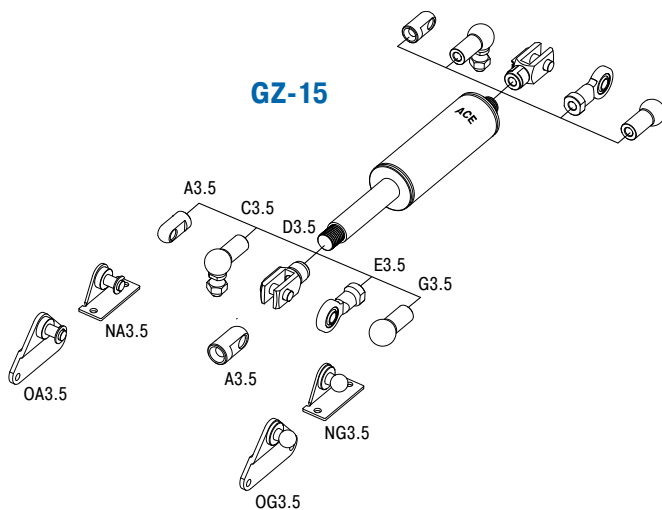

Technical Data

Traction force: 11 lbs to 34 lbs (extended up to 41 lbs)

Progression: Approx. 12 % to 22 %

Lifetime: Approx. 6,561 ft

Operating temperature range: -4 °F to +176 °F

Material: Outer body, End fittings: Zinc plated steel; Piston rod: Stainless steel (1.4301/1.4305, AISI 304/303)

Mounting: With piston rod upwards.

End position damping length: Without damping. For end position damping use damping material (e.g. TUBUS or SLAB).

Positive stop: External positive stop at the end of stroke provided by the customer.

End fittings: They are interchangeable and if necessary must be positively secured by the customer to prevent unscrewing.

Valve Technology, Traction force 9 lbs to 79 lbs (extended up to 101 lbs)

End Fitting

Standard Dimensions

End Fitting

A8

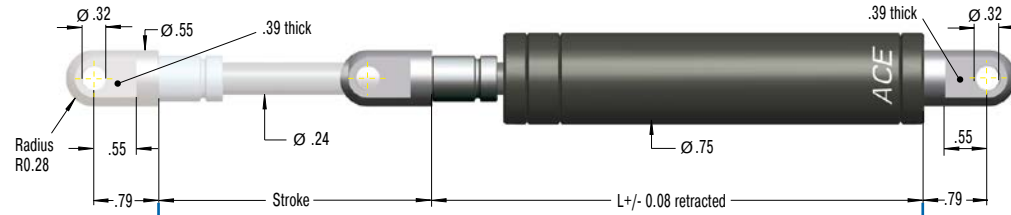

Eye A8
max. force 674 lbs

B8

C8

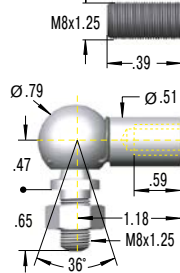

Performance and Dimensions

| TYPES | Stroke inch | L retracted inch | Traction force max. lbs |
|-----------|----------------|---------------------|----------------------------|
| GZ-19-30 | 1.18 | 4.41 | 79 |
| GZ-19-50 | 1.97 | 5.20 | 79 |
| GZ-19-100 | 3.94 | 7.17 | 79 |
| GZ-19-150 | 5.91 | 9.13 | 79 |
| GZ-19-200 | 7.87 | 11.10 | 79 |
| GZ-19-250 | 9.84 | 13.07 | 79 |

Stud Thread B8

Angle Ball Joint C8

max. force 270 lbs
Also available with UNF thread 5/16-18.
Order G5/16.

D8

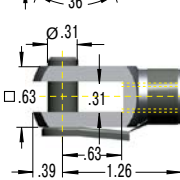

Ordering Example

GZ-19-150-AC-V-250

- Type (Pull Type) _____
- Body 0.75" (19 mm) _____
- Stroke 5.91" (150 mm) _____
- Piston Rod End Fitting A8 _____
- Body End Fitting C8 _____
- Adjustable (V) _____
- Traction Force F₁ 56 lbs (250 N) _____

Clevis Fork D8
max. force 674 lbs

E8

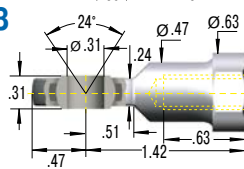

Swivel Eye E8
max. force 674 lbs

G8

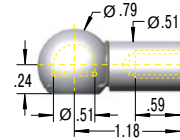

Ball Socket G8
max. force 270 lbs

Mounting accessories see from page 212.

Rod Shroud W8-19

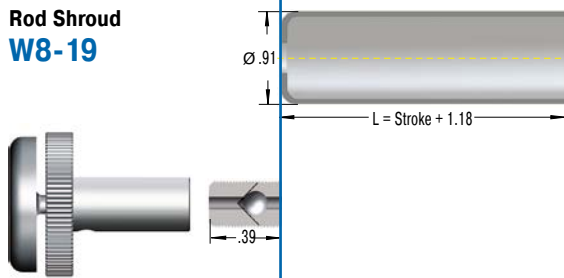

Adjuster Knob DE-GAS-8

See page 191.

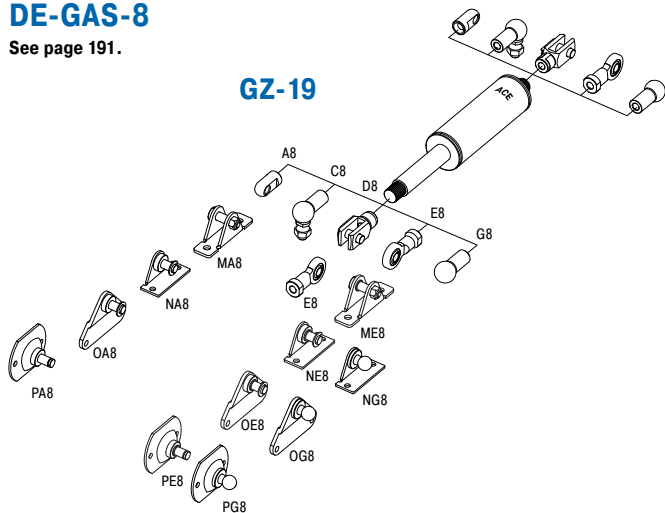

Technical Data

- Traction force:** 9 lbs to 79 lbs (extended up to 101 lbs)
- Progression:** Approx. 21 % to 28 %
- Lifetime:** Approx. 6,561 ft
- Operating temperature range:** -4 °F to +176 °F
- Material:** Outer body, End fittings: Zinc plated steel; Piston rod: Steel with wear-resistant coating
- Mounting:** With piston rod upwards.
- End position damping length:** Without damping. For end position damping use damping material (e.g. TUBUS or SLAB).
- Positive stop:** External positive stop at the end of stroke provided by the customer.
- End fittings:** They are interchangeable and if necessary must be positively secured by the customer to prevent unscrewing.

Valve Technology, Traction force 34 lbs to 270 lbs (extended up to 351 lbs)

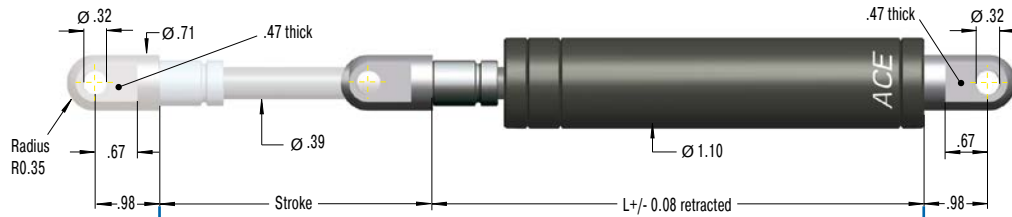
End Fitting
Standard Dimensions
End Fitting
A10

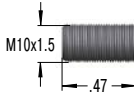
Eye A10
 max. force 2,248 lbs

B10

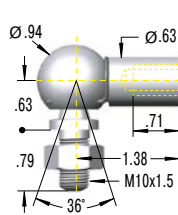
Performance and Dimensions

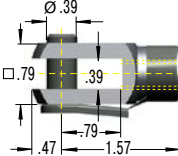
| TYPES | Stroke inch | L retracted inch | Traction force max. lbs |
|-----------|----------------|---------------------|----------------------------|
| GZ-28-30 | 1.18 | 5.12 | 270 |
| GZ-28-50 | 1.97 | 5.91 | 270 |
| GZ-28-100 | 3.94 | 7.87 | 270 |
| GZ-28-150 | 5.91 | 9.84 | 270 |
| GZ-28-200 | 7.87 | 11.81 | 270 |
| GZ-28-250 | 9.84 | 13.78 | 270 |
| GZ-28-300 | 11.81 | 15.75 | 270 |
| GZ-28-350 | 13.78 | 17.72 | 270 |
| GZ-28-400 | 15.75 | 19.69 | 270 |
| GZ-28-450 | 17.72 | 21.65 | 270 |
| GZ-28-500 | 19.69 | 23.62 | 270 |
| GZ-28-550 | 21.65 | 25.59 | 270 |
| GZ-28-600 | 23.62 | 27.56 | 270 |
| GZ-28-650 | 25.59 | 29.53 | 270 |

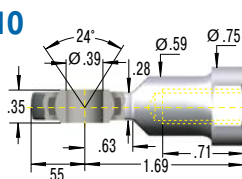
Stud Thread B10
C10

Angle Ball Joint C10
 max. force 405 lbs

D10

Clevis Fork D10
 max. force 2,248 lbs

E10

Swivel Eye E10
 max. force 2,248 lbs

Ordering Example
GZ-28-150-EE-V-800

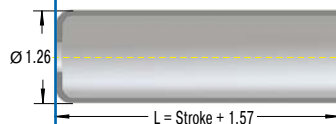
Type (Pull Type) _____
 Body 1.10" (28 mm) _____
 Stroke 5.91" (150 mm) _____
 Piston Rod End Fitting E10 _____
 Body End Fitting E10 _____
 Adjustable (V) _____
 Traction Force F₁ 180 lbs (800 N) _____

Mounting accessories see from page 212.

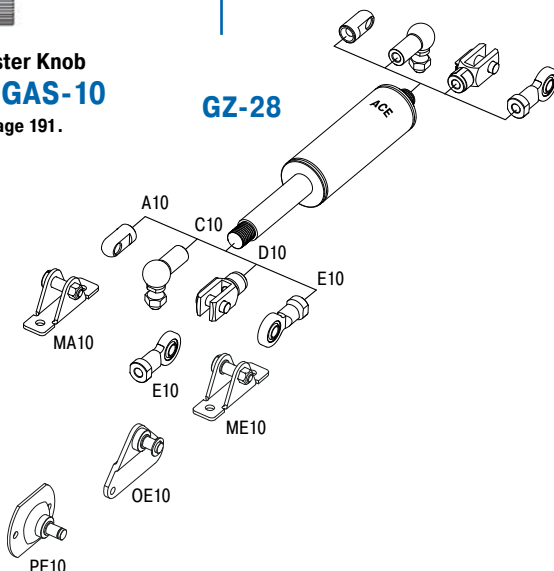
Rod Shroud W10-28

Adjuster Knob DE-GAS-10
 See page 191.

GZ-28

Technical Data

- Traction force:** 34 lbs to 270 lbs (extended up to 351 lbs)
- Progression:** Approx. 28 % to 30 %
- Lifetime:** Approx. 6,561 ft
- Operating temperature range:** -4 °F to +176 °F
- Material:** Outer body, End fittings: Zinc plated steel; Piston rod: Steel with wear-resistant coating
- Mounting:** With piston rod upwards.
- End position damping length:** Without damping. For end position damping use damping material (e.g. TUBUS or SLAB).
- Positive stop:** External positive stop at the end of stroke provided by the customer.
- End fittings:** They are interchangeable and if necessary must be positively secured by the customer to prevent unscrewing.

Valve Technology, Traction force 112 lbs to 1,124 lbs (extended up to 1,630 lbs)

End Fitting

Standard Dimensions

End Fitting

A14

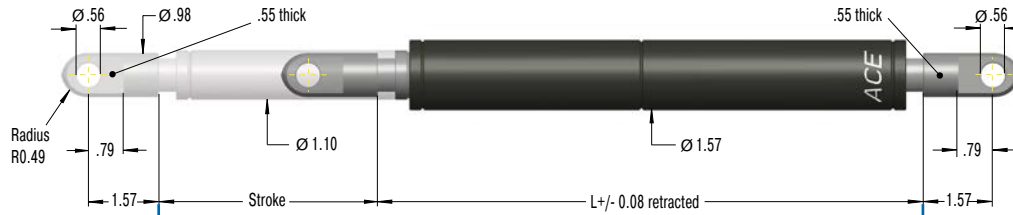

Eye A14
max. force 2,248 lbs

B14

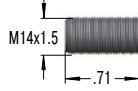

Stud Thread B14

C14

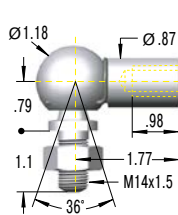

Angle Ball Joint C14
max. force 719 lbs

D14

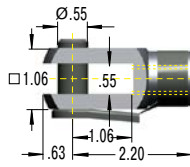

Clevis Fork D14
max. force 2,248 lbs

E14

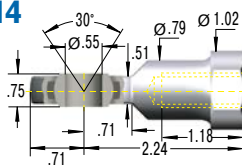

Swivel Eye E14
max. force 2,248 lbs

Performance and Dimensions

| TYPES | Stroke inch | L retracted inch | Traction force max. lbs |
|-----------|----------------|---------------------|----------------------------|
| GZ-40-100 | 3.94 | 9.84 | 1,124 |
| GZ-40-150 | 5.91 | 12.80 | 1,124 |
| GZ-40-200 | 7.87 | 15.75 | 1,124 |
| GZ-40-250 | 9.84 | 18.70 | 1,124 |
| GZ-40-300 | 11.81 | 21.65 | 1,124 |
| GZ-40-400 | 15.75 | 27.56 | 1,124 |
| GZ-40-500 | 19.69 | 33.46 | 1,124 |
| GZ-40-600 | 23.62 | 39.37 | 1,124 |

Ordering Example

GZ-40-150-EE-V-800

- Type (Pull Type) _____
- Body 1.57" (40 mm) _____
- Stroke 5.91" (150 mm) _____
- Piston Rod End Fitting E14 _____
- Body End Fitting E14 _____
- Adjustable (V) _____
- Traction Force F₁ 180 lbs (800 N) _____

Mounting accessories see from page 212.

Rod Shroud W14-40

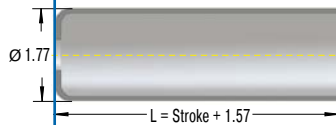

Adjuster Knob DE-GAS-14

See page 191.

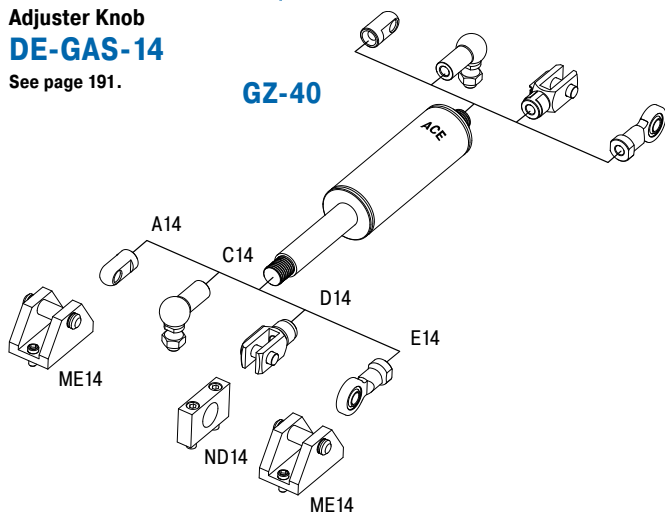

Technical Data

- Traction force:** 112 lbs to 1,124 lbs (extended up to 1,630 lbs)
- Progression:** Approx. 43 % to 45 %
- Lifetime:** Approx. 6,561 ft
- Operating temperature range:** -4 °F to +176 °F
- Material:** Outer body, End fittings: Zinc plated steel; Piston rod: Steel with wear-resistant coating
- Mounting:** With piston rod upwards.
- End position damping length:** Without damping. For end position damping use damping material (e.g. TUBUS or SLAB).
- Positive stop:** External positive stop at the end of stroke provided by the customer.
- End fittings:** They are interchangeable and if necessary must be positively secured by the customer to prevent unscrewing.

ACE Easy Sizing

Just a few simple steps to your perfect ACE Gas Spring

NEW !

1

Select the position of flap and pivot point.

2

Specify your application within our 3D-simulator.

3

Calculate your ACE Gas Springs.

4

Add mounting accessories.

5

Send an order request.

Talk to us!

Sometimes your problems are more complicated than an online tool can solve. ACE application engineers have the skills, knowledge and training to deliver a solution.

1-800-521-3320

The screenshot shows the ACE Easy Sizing web application interface. At the top, there is a navigation bar with the ACE logo and 'ACE Controls Inc.' followed by menu items: Products, Applications, Calculations (highlighted), CAD & Downloads, Company, and Sales & Contact. Below the navigation bar, there is a search bar and a 'Select Region' dropdown set to 'United States of America'. The main content area features a header with the text 'Just a few steps to your perfect fitting gas spring' and 'ACE Sizing Tools & Services'. A 'Gas Springs - easy mounting...' section includes an 'ACE TIPS' button. The main interface is divided into several sections: 'ACE Easy Sizing' (sub-section: 'Gas Springs (Push Type)', 'GS-8 to GS-40'), 'Simulation' (3D model of a gas spring mechanism), 'Details of Flap' (input fields for Length: 800 mm, Width: 2400 mm, Height: 40 mm, Handle Distance: 800 mm, Mass: 60 kg, Opening angle: 88°, Number of gas springs: 2, Hinge Position: Bottom), 'Material' (Steel, coated (NEWTOLINE), Ambient temperature: 20 °C), 'Hand Force Trajectory' (graph showing force vs. angle), 'Configuration' (Filling pressure: 31.5 %, End fitting (piston rod): Eye A, Matching gas springs: GS-22-300, End fitting (cylinder): Eye A, Mounting bracket (piston rod): MA, Mounting bracket (cylinder): MA), and a 'Calculate Your Gas Spring(s)' button. At the bottom, there is an 'Amount' field set to 2 and a 'How to Order' button with a shopping cart icon.

All available at
www.acecontrols.com

Calculations



GZ-15-V4A to GZ-40-VA

Very low progression rate with FDA approval

Valve Technology, Stainless Steel

Traction force 9 lbs to 1,124 lbs

Stroke 0.79 in to 23.62 in

Brilliant performance when things become tight: For specific use e.g. in tough surroundings or small spaces, the broad spectrum of ACE stainless steel industrial pull type gas springs come in body diameters from 0.59" to 1.57" (15 to 40 mm). These units supplement the comprehensive program of the ACE industrial pull type gas springs with valves.

This high quality design is rust free and is more robust against environmental impact compared with standard gas pull type springs. These stainless steel gas springs are also visually appealing, very durable and available, upon request, in many stroke lengths and traction forces. A comprehensive range of accessories in stainless steel guarantees easy assembly and a broad range of uses.

ACE industrial push type springs made of stainless steel are used in industries such as the chemical and food industry, in automobiles, plant engineering and shipbuilding and also in medical, military, environmental and water supply technology.

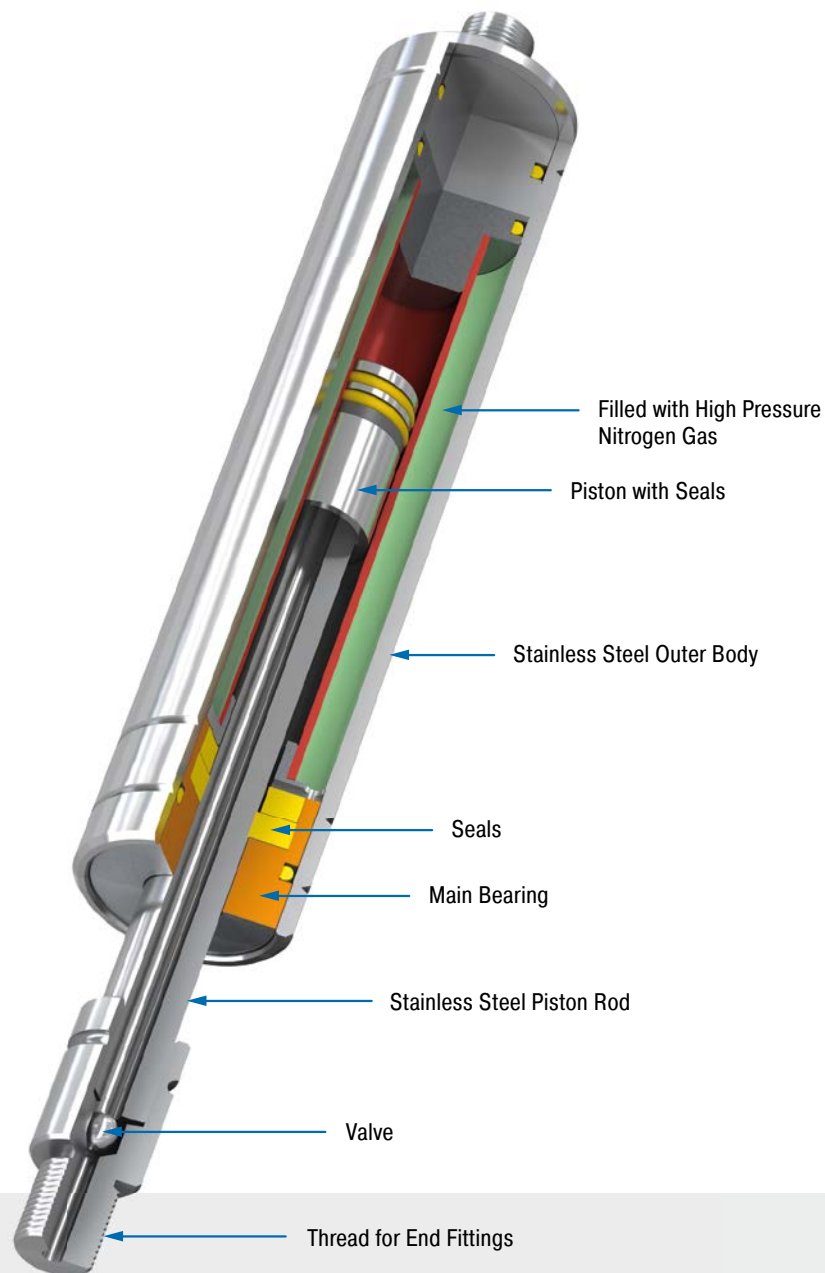

Technical Data

Traction force: 9 lbs to 1,124 lbs

Piston rod diameter: Ø 0.16 in to Ø 1.10 in

Progression: Approx. 11 % to 45 %

Lifetime: Approx. 50,000 cycles

Operating temperature range: -4 °F to +176 °F

Material: Outer body, Piston rod, End fittings: Stainless steel (1.4301/1.4305, AISI 304/303 and 1.4404/1.4571, AISI 316L/316Ti)

Operating fluid: Nitrogen gas

Mounting: With piston rod upwards.

End position damping length: Without damping. For end position damping use damping material (e.g. TUBUS or SLAB).

Positive stop: External positive stop in the pulling direction provided by the customer.

Application field: Hoods, Shutters, Machine housing, Conveyor systems, Control boxes, Furniture industry, Shipbuilding, Food industry, Pharmaceutical industry, Folding elements

End fittings: They are interchangeable and if necessary must be positively secured by the customer to prevent unscrewing.

On request: Special oils and other special options. Alternative accessories. Traction gas springs with end position damping also available on request. Other traction gas springs material 1.4404/1.4571, AISI 316L/316Ti (V4A) available on request.

Valve Technology, Stainless Steel, Traction force 11 lbs to 34 lbs (extended up to 41 lbs)

End Fitting

Standard Dimensions

End Fitting

B3.5 Stud Thread **B3.5**

A3.5-V4A Eye **A3.5-V4A**
max. force 83 lbs

C3.5-V4A Angle Ball Joint **C3.5-V4A**
max. force 83 lbs

D3.5-V4A Clevis Fork **D3.5-V4A**
max. force 83 lbs

G3.5-V4A Ball Socket **G3.5-V4A**
max. force 83 lbs

Adjuster Knob DE-GAS-3.5
See page 191.

Performance and Dimensions

| TYPES | Stroke inch | L retracted inch | Traction force max. lbs |
|---------------|----------------|---------------------|----------------------------|
| GZ-15-20-V4A | 0.79 | 3.43 | 34 |
| GZ-15-40-V4A | 1.57 | 4.21 | 34 |
| GZ-15-50-V4A | 1.97 | 4.61 | 34 |
| GZ-15-60-V4A | 2.36 | 5.00 | 34 |
| GZ-15-80-V4A | 3.15 | 5.79 | 34 |
| GZ-15-100-V4A | 3.94 | 6.57 | 34 |
| GZ-15-120-V4A | 4.72 | 7.36 | 34 |
| GZ-15-150-V4A | 5.91 | 8.54 | 34 |

Ordering Example

GZ-15-150-AC-V-150-V4A

Type (Pull Type) _____

Body 0.61" (15.6 mm) _____

Stroke 5.91" (150 mm) _____

Piston Rod End Fitting A3.5-V4A _____

Body End Fitting C3.5-V4A _____

Adjustable (V) _____

Traction Force F₁ 34 lbs (150 N) _____

Material (1.4404/1.4571, AISI 316L/316Ti, V4A) _____

Mounting accessories see from page 220.

GZ-15-V4A

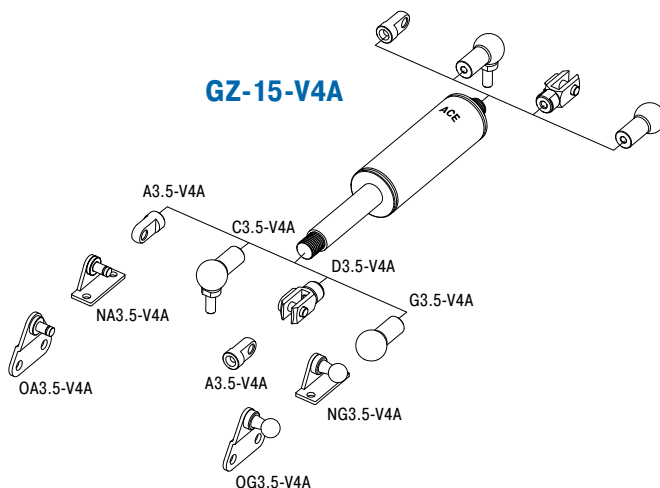

Technical Data

Traction force: 11 lbs to 34 lbs (extended up to 41 lbs)

Progression: Approx. 11 % to 21 %

Lifetime: Approx. 50,000 cycles

Operating temperature range: -4 °F to +176 °F

Material: Outer body, Piston rod, End fittings: Stainless steel (1.4404/1.4571, AISI 316L/316Ti)

Mounting: With piston rod upwards.

End position damping length: Without damping. For end position damping use damping material (e.g. TUBUS or SLAB).

Positive stop: External positive stop in the pulling direction provided by the customer.

End fittings: They are interchangeable and if necessary must be positively secured by the customer to prevent unscrewing.

Valve Technology, Stainless Steel, Traction force 9 lbs to 79 lbs (extended up to 101 lbs)

End Fitting

Standard Dimensions

End Fitting

B8 Stud Thread **B8**

A8-VA Eye **A8-VA** max. force 351 lbs

C8-VA Angle Ball Joint **C8-VA** max. force 256 lbs

D8-VA Clevis Fork **D8-VA** max. force 351 lbs

E8-VA Swivel Eye **E8-VA** max. force 351 lbs

G8-VA Ball Socket **G8-VA** max. force 256 lbs

W8-19-VA Rod Shroud

Stroke: .39
 L +/- 0.08 retracted
 Ø.24
 Ø.75
 .39 thick
 Radius R0.28
 Ø.55
 .45
 .39
 .75
 Ø.79
 Ø.51
 .47
 .59
 .65
 1.18
 M8x1.25
 36°
 Ø.31
 .87
 .63
 .31
 .39
 .63
 1.26
 24°
 Ø.31
 .24
 Ø.47
 Ø.63
 .47
 .51
 1.42
 .63
 .47
 Ø.79
 Ø.51
 .24
 Ø.51
 .59
 1.18
 Ø.91
 L = Stroke + 1.18
 .39

| Performance and Dimensions | | | |
|----------------------------|----------------|---------------------|----------------------------|
| TYPES | Stroke inch | L retracted inch | Traction force max. lbs |
| GZ-19-30-VA | 1.18 | 5.12 | 79 |
| GZ-19-50-VA | 1.97 | 5.91 | 79 |
| GZ-19-100-VA | 3.94 | 7.87 | 79 |
| GZ-19-150-VA | 5.91 | 9.84 | 79 |
| GZ-19-200-VA | 7.87 | 11.81 | 79 |
| GZ-19-250-VA | 9.84 | 13.78 | 79 |

Ordering Example **GZ-19-150-AC-V-150-VA**

Type (Pull Type) _____
 Body 0.75" (19 mm) _____
 Stroke 5.91" (150 mm) _____
 Piston Rod End Fitting A8-VA _____
 Body End Fitting C8-VA _____
 Adjustable (V) _____
 Traction Force F₁ 34 lbs (150 N) _____
 Material (1.4301/1.4305, AISI 304/303, VA) _____

Mounting accessories see from page 220.

Adjuster Knob DE-GAS-8
 See page 191.

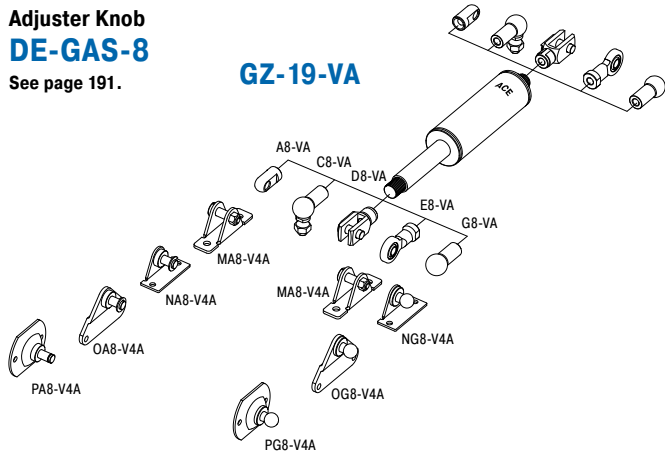

Technical Data

- Traction force:** 9 lbs to 79 lbs (extended up to 101 lbs)
- Progression:** Approx. 23 % to 28 %
- Lifetime:** Approx. 50,000 cycles
- Operating temperature range:** -4 °F to +176 °F
- Material:** Outer body, Piston rod, End fittings: Stainless steel (1.4301/1.4305, AISI 304/303)
- Mounting:** With piston rod upwards.
- End position damping length:** Without damping. For end position damping use damping material (e.g. TUBUS or SLAB).
- Positive stop:** External positive stop in the pulling direction provided by the customer.
- End fittings:** They are interchangeable and if necessary must be positively secured by the customer to prevent unscrewing.

Issue 04.2018 – Specifications subject to change

Valve Technology, Stainless Steel, Traction force 34 lbs to 270 lbs (extended up to 351 lbs)

End Fitting

Standard Dimensions

End Fitting

B10

M10x1.5

Ø.39

Stroke

L +/- 0.08 retracted

Ø1.10

.47

Performance and Dimensions

| TYPES | Stroke inch | L retracted inch | Traction force max. lbs |
|--------------|----------------|---------------------|----------------------------|
| GZ-28-50-VA | 1.97 | 6.50 | 270 |
| GZ-28-100-VA | 3.94 | 8.46 | 270 |
| GZ-28-150-VA | 5.91 | 10.43 | 270 |
| GZ-28-200-VA | 7.87 | 12.40 | 270 |
| GZ-28-250-VA | 9.84 | 14.37 | 270 |
| GZ-28-300-VA | 11.81 | 16.34 | 270 |
| GZ-28-350-VA | 13.78 | 18.31 | 270 |
| GZ-28-400-VA | 15.75 | 20.28 | 270 |
| GZ-28-450-VA | 17.72 | 22.24 | 270 |
| GZ-28-500-VA | 19.69 | 24.21 | 270 |
| GZ-28-550-VA | 21.65 | 26.18 | 270 |
| GZ-28-600-VA | 23.62 | 28.15 | 270 |

Stud Thread B10

Eye A10-VA
max. force 854 lbs

Angle Ball Joint C10-VA
max. force 393 lbs

Clevis Fork D10-VA
max. force 854 lbs

Swivel Eye E10-VA
max. force 854 lbs

Ordering Example

GZ-28-150-EE-V-800-VA

Type (Pull Type) _____

Body 1.10" (28 mm) _____

Stroke 5.91" (150 mm) _____

Piston Rod End Fitting E10-VA _____

Body End Fitting E10-VA _____

Adjustable (V) _____

Traction Force F₁ 180 lbs (800 N) _____

Material (1.4301/1.4305, AISI 304/303, VA) _____

Mounting accessories see from page 220.

Adjuster Knob DE-GAS-10

See page 191.

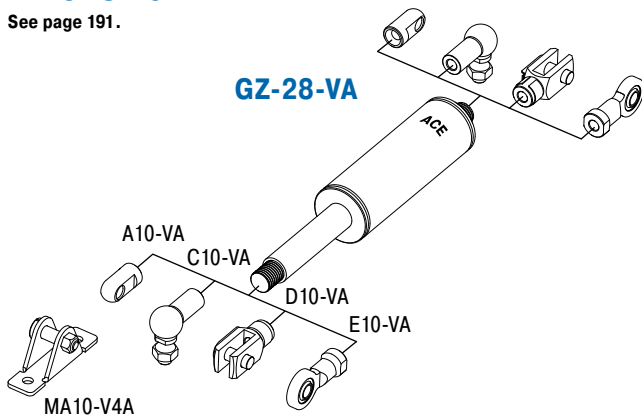

Technical Data

Traction force: 34 lbs to 270 lbs (extended up to 351 lbs)

Progression: Approx. 29 % to 30 %

Lifetime: Approx. 50,000 cycles

Operating temperature range: -4 °F to +176 °F

Material: Outer body, Piston rod, End fittings: Stainless steel (1.4301/1.4305, AISI 304/303)

Mounting: With piston rod upwards.

End position damping length: Without damping. For end position damping use damping material (e.g. TUBUS or SLAB).

Positive stop: External positive stop in the pulling direction provided by the customer.

End fittings: They are interchangeable and if necessary must be positively secured by the customer to prevent unscrewing.

Valve Technology, Stainless Steel, Traction force 112 lbs to 1,124 lbs (extended up to 1,630 lbs)

End Fitting

Standard Dimensions

End Fitting

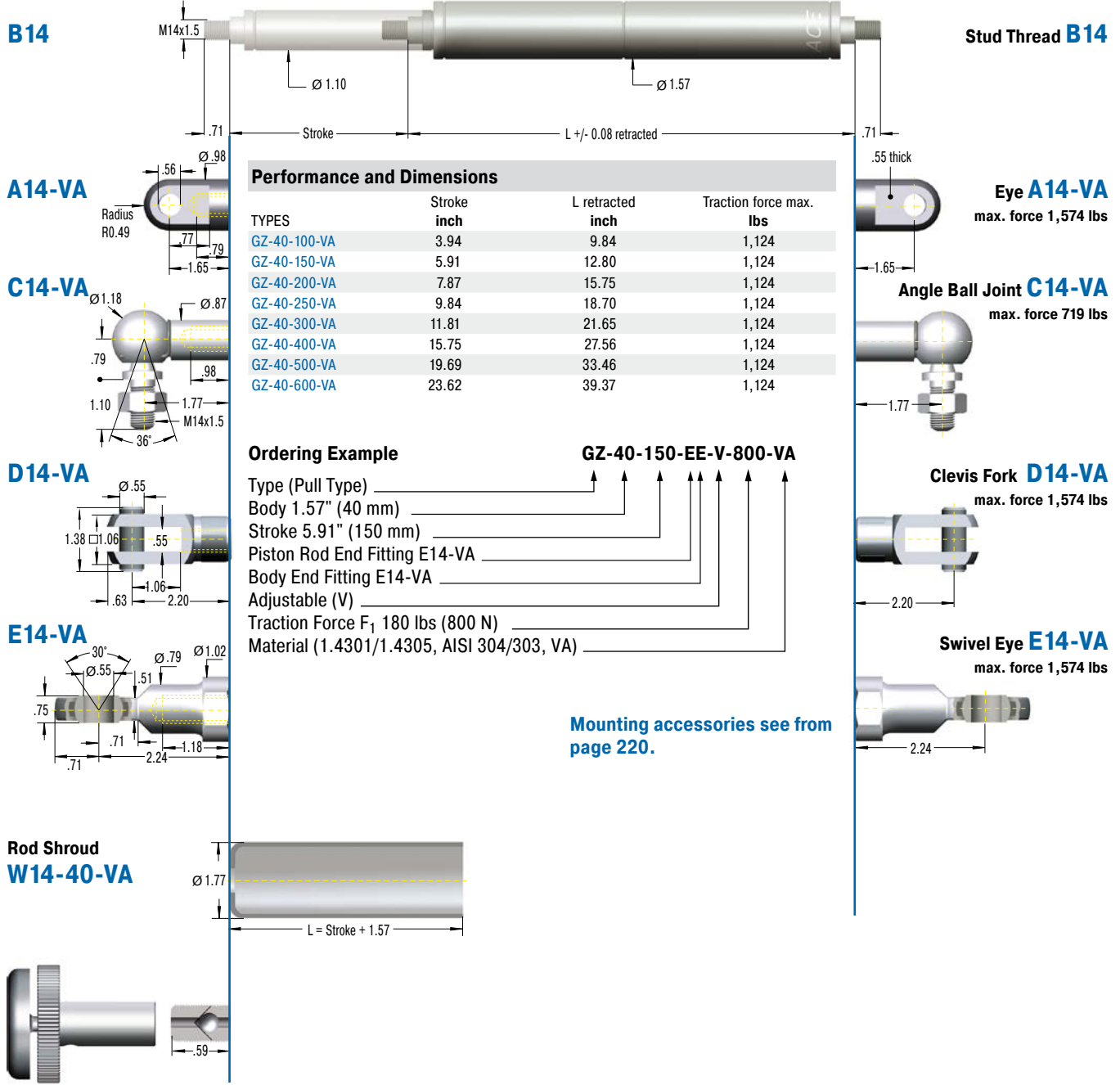

Adjuster Knob DE-GAS-14
See page 191.

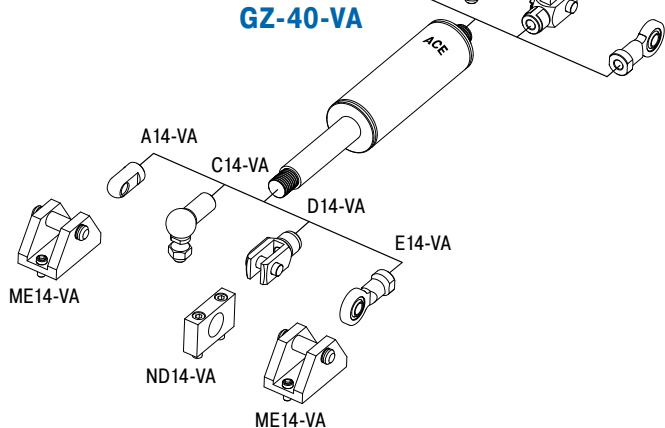

Technical Data

- Traction force:** 112 lbs to 1,124 lbs (extended up to 1,630 lbs)
- Progression:** Approx. 43 % to 45 %
- Lifetime:** Approx. 50,000 cycles
- Operating temperature range:** -4 °F to +176 °F
- Material:** Outer body, Piston rod, End fittings: Stainless steel (1.4301/1.4305, AISI 304/303)
- Mounting:** With piston rod upwards.
- End position damping length:** Without damping. For end position damping use damping material (e.g. TUBUS or SLAB).
- Positive stop:** External positive stop in the pulling direction provided by the customer.
- End fittings:** They are interchangeable and if necessary must be positively secured by the customer to prevent unscrewing.

Issue 04.2018 – Specifications subject to change

Stainless Steel Gas Springs (Pull Type), V4A

| TYPES | Stroke inch | L retracted inch | Dimensions see Page |
|---------------|----------------|---------------------|------------------------|
| GZ-19-30-V4A | 1.18 | 5.12 | 184 |
| GZ-19-50-V4A | 1.97 | 5.91 | 184 |
| GZ-19-100-V4A | 3.94 | 7.87 | 184 |
| GZ-19-150-V4A | 5.91 | 9.84 | 184 |
| GZ-19-200-V4A | 7.87 | 11.81 | 184 |
| GZ-19-250-V4A | 9.84 | 13.78 | 184 |
| GZ-28-50-V4A | 1.97 | 6.50 | 185 |
| GZ-28-100-V4A | 3.94 | 8.46 | 185 |
| GZ-28-150-V4A | 5.91 | 10.43 | 185 |
| GZ-28-200-V4A | 7.87 | 12.40 | 185 |
| GZ-28-250-V4A | 9.84 | 14.37 | 185 |
| GZ-28-300-V4A | 11.81 | 16.34 | 185 |
| GZ-28-350-V4A | 13.78 | 18.31 | 185 |
| GZ-28-400-V4A | 15.75 | 20.28 | 185 |
| GZ-28-450-V4A | 17.72 | 22.24 | 185 |
| GZ-28-500-V4A | 19.69 | 24.21 | 185 |
| GZ-28-550-V4A | 21.65 | 26.18 | 185 |
| GZ-28-600-V4A | 23.62 | 28.15 | 185 |
| GZ-40-100-V4A | 3.94 | 9.84 | 186 |
| GZ-40-150-V4A | 5.91 | 12.80 | 186 |
| GZ-40-200-V4A | 7.87 | 15.75 | 186 |
| GZ-40-250-V4A | 9.84 | 18.70 | 186 |
| GZ-40-300-V4A | 11.81 | 21.65 | 186 |
| GZ-40-400-V4A | 15.75 | 27.56 | 186 |
| GZ-40-500-V4A | 19.69 | 33.46 | 186 |
| GZ-40-600-V4A | 23.62 | 39.37 | 186 |

Stainless Steel Accessories, V4A

| TYPES | Dimensions see Page |
|---------|------------------------|
| A5-V4A | 222 |
| C5-V4A | 222 |
| D5-V4A | 222 |
| E5-V4A | 222 |
| G5-V4A | 222 |
| A8-V4A | 223 |
| C8-V4A | 223 |
| D8-V4A | 223 |
| E8-V4A | 223 |
| G8-V4A | 224 |
| A10-V4A | 224 |
| C10-V4A | 224 |
| D10-V4A | 224 |
| E10-V4A | 224 |
| A14-V4A | 225 |
| C14-V4A | 225 |
| D14-V4A | 225 |
| E14-V4A | 225 |

We'll Size Industrial Gas Springs for You

And we'll provide all necessary information for installation

To obtain the optimum operation with minimal hand force, gas spring must be properly sized and the mounting points have to be optimally placed.

It is important to identify the following points:

- gas spring size
- required gas spring stroke
- mounting points on flap and frame
- extended length of the gas spring
- required extension force
- hand forces throughout the complete movement on the flap

With our free calculation service you can eliminate the time-consuming calculation and send us your details by fax or e-mail. Just complete the information shown on the following page. Please attach a sketch of your application (a simple hand sketch is sufficient) in side view. Our application engineers will determine the optimum gas springs and mounting points and calculate the ideal situation to satisfy your requirements.

You will receive a quotation showing the opening and closing forces and our recommended mounting points to suit your application.

Example of a Calculation Offer

| Input data - Identification data | | | |
|----------------------------------|-----------------|-------------|-----------|
| Start angle | α : 0 ° | Temperature | : 68 °F |
| Open angle | α : 90 ° | Progression | : 32 % |
| Rd. ctr.grvty. | RM: 9.02 in. | Friction | : 20 N |
| Mass | m: 25 lb. | Ext. length | : 8.6 in. |
| No. gas springs | n: 2 | | |
| Rd. handforce | RB: 17.99 in. | | |
| Dist. of fitting | L1: 0.79 in. | | |

Required user hand-forces

F1-F2/F3-F4=Hand forces for opening/closing

| Angle [°] | F1-F2 [lbs] | F3-F4 [lbs] | Length [in.] |
|-----------|-------------|-------------|--------------|
| 0 | -3 | -2 | 5.75 |
| 20 | -3 | -2 | 6.57 |
| 40 | -3 | -2 | 7.32 |
| 60 | -1 | 0 | 7.95 |
| 80 | 1 | 2 | 8.43 |
| 90 | 2 | 3 | 8.58 |

F1-F4 positive requires clockwise hand force
F1-F4 negative requires counter-clockwise hand force

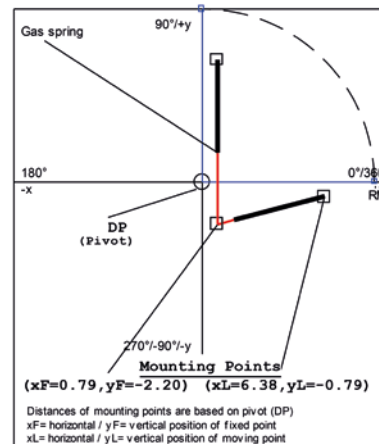

Input Data

Gas Spring Push type Gas Spring Pull type

Gas spring fixing points

The fixed point of the frame and the moving point of the flap are critical for the optimum operation.

Please attach a sketch of your application!
(A few lines with dimensions are sufficient)

Moving mass* m _____ lbs
 Number of gas springs in parallel* n _____ pcs
 Number of movements* _____ /day
 Ambient temperature T _____ °F

If not shown by the sketch:

Radius of center of gravity R_M _____ inches
 Radius of hand force R_H _____ inches
 Starting angle α_M _____ °
 Opening angle α _____ °

* Compulsory information

Desired Mounting Fittings

- | End Fitting | | End Fitting |
|----------------------------|---------------------|----------------------------|
| <input type="checkbox"/> A | | A <input type="checkbox"/> |
| <input type="checkbox"/> B | B Stud Thread | B <input type="checkbox"/> |
| <input type="checkbox"/> C | C Angle Ball Joint | C <input type="checkbox"/> |
| <input type="checkbox"/> D | D Clevis Fork | D <input type="checkbox"/> |
| <input type="checkbox"/> E | E Swivel Eye | E <input type="checkbox"/> |
| <input type="checkbox"/> F | F Inline Ball Joint | F <input type="checkbox"/> |
| <input type="checkbox"/> G | G Ball Socket | G <input type="checkbox"/> |

The end fittings are interchangeable

e.g. -CE: C = Angle Ball Joint, E = Swivel Eye

Hood

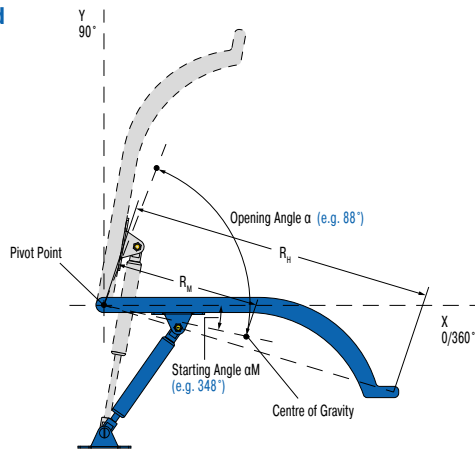

Flap

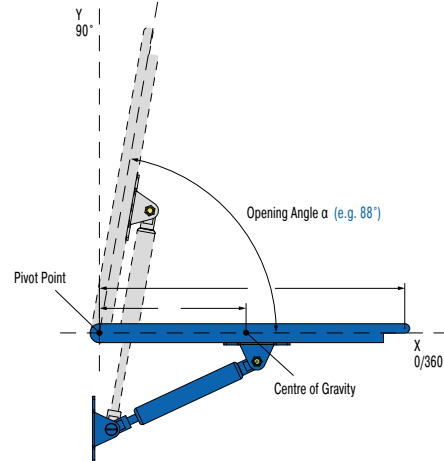

Please send us a sketch with dimensions of your application!
Without this sketch we won't be able to calculate.

| | |
|--------------------------|--|
| Comments | |
| Requirement per year | |
| Machine type / reference | |

Sender

| | | | |
|------------|--|-----------|--|
| Company | | Dept. | |
| Address | | Name | |
| ZIP / City | | Telephone | |
| Website | | E-Mail | |

Please complete and fax or email to: (248) 476-2470 or applications@acecontrols.com

Mounting and Safety Instructions

Filling

Gas springs are filled with pure nitrogen gas. Nitrogen is an inert gas that does not burn or explode and is not poisonous. The internal pressure of gas springs can be up to 300 bar (4,350 psi). Do not attempt to open or modify them!

Gas springs are maintenance-free!

ACE gas springs will operate in ambient temperatures from -4 °F to +176 °F.

We can equip our springs with special seals to withstand temperatures as low as -49 °F or as high as +392 °F.

Gas springs should not be placed over heat or in open fire!

ACE gas springs can be stored in any position. Pressure lost through long storage is not to be expected. There are no known negative effects of long-term storage, but there may be a sticking effect the first time you compress a spring. This may require a higher initial force to operate the gas spring for the first time (initial breakaway force).

Mounting

Gas springs should be installed with the piston rod downwards. This position ensures best damping quality. ACE gas springs include an integrated grease chamber which allows for alternative mounting opportunities.

The tolerance for the installation length is generally deemed to be ± 0.08 in. If very high demands are placed on durability and stability, please avoid the combination of small diameter + long stroke + high force.

The filling tolerance is -4.50 lbs to 9.00 lbs or 5 % to 7 %. Depending on size and extension force the tolerances can differ.

Life Time

Generally, ACE gas springs are tested to 70,000 to 100,000 complete strokes. This is equivalent to the seal lifetime (depending on model size) to a distance travelled of 6.21 miles (lifetime of traction gas springs approx. 1.24 miles). During these tests the gas spring must not lose more than 5 % of its pressure. Depending upon the application and operating environment, the service life of these gas springs may be much longer. In practice 500,000 strokes or more have been achieved on some applications.

Disposal/Recycling

Please ask for our disposal recommendations.

Warnings and Liability

All gas springs are marked with the part number, the production date and a warning sign "Do not open high pressure".

We are not responsible for any damages of any kind that arises due to goods that are not marked accordingly.

Valve Actuation with ACE DE-GAS

Simple, safe and reliable

De-gassing for controlled force reduction on valve gas springs

The reduction is made by screwing the DE-Gas on the male screwed end of the gas spring. The drain process is possible through light actuation of the push button. If too much nitrogen is discharged, the gas spring can be refilled by ACE.

Adjustment

1. Hold gas spring valve up.
2. Insert DE-GAS adjuster knob on thread of the valve.
3. Press the DE-GAS adjuster knob with light hand force until you can hear the nitrogen escaping. Press only briefly to avoid too much nitrogen being discharged.
4. After adjustment, remove the DE-GAS adjuster knob, mount the end fittings and test the gas spring in your application. If necessary repeat the procedure.

If you use 2 gas springs in parallel, both gas springs should have the same force to avoid bending forces or side load on the application. If necessary return to ACE to refill both gas springs to the same (average) force.

If too much nitrogen is discharged, the units can be returned to ACE for re-gassing.



DE-GAS

You can also visit our Youtube channel at www.youtube.com/user/acecontrolsglobal
Here, among other things you will find an ACETips video on the topic of DE-GAS!

Gas Spring Refilling Kit

Flexible and easy to use

The ACE gas spring refilling kit offers you the opportunity to fill gas springs on location or adapt them individually. The refilling kit is equipped with all the parts you need to fill gas springs. Very precise filling of the gas springs is possible using the digital manometer. The table for determining the filling pressure of the gas springs is included with the case. The only thing missing from the delivery is the nitrogen.



The refilling kit contains all filling bells and adjuster knobs for the current ACE gas spring range.

Gas springs filled with the refilling kit must be measured on a calibrated measurement system by ACE for repeat production.

The refilling kit suits 2,900 psi nitrogen bottles with a thread of W24.32x1/14". Other connections are available upon request.

Part number: **GS-FK-C**

Hydraulic Dampers

Multi-talent in speed control

The ACE hydraulic dampers are similar in appearance to our industrial gas springs but are adjusted in the end position and work differently to the DVC family with individual speed adjusters for the push and pull direction. This provides users with the maximum flexibility.

Whether used as drive compensation or safety element, the retraction and extension speed of these ACE solutions can always be precisely set. This means that the speed of movement can be controlled, synchronization regulated in both directions and pivoting loads can be compensated. Depending on the model, the push and pull forces are between 6.75 lb to 2,023 lb (30 N and 40,000 N). These maintenance-free, ready-to-install products are available in body diameters of 0.47 in to 2.75 in (12 mm to 70 mm) and in stroke lengths up to 31.50 in (800 mm).



Hydraulic Dampers



DVC-32 and DVC-2 to DVC-6

Page 194

Adjustable, Without Free Travel
Multi-directional speed adjustment
 Cylinder speed controls, Absorption control, Finishing and processing centers



HBD-15 to HBD-40

Page 196

Adjustable
Regulation at the highest level
 Finishing and processing centers, Machine housing, Hoods, Shutters



HB-12 to HB-70

Page 202

Adjustable
Linear motion control
 Conveyor systems, Transport systems, Furniture industry, Locking systems

Constant speed rates

Sensitive adjustment

High quality and long lifetime

Easy to mount



DVC-32 and DVC-2 to DVC-6

Multi-directional speed adjustment

Adjustable, Without Free Travel

Compression and extension force 9.44 lbs to 450 lbs

Stroke 2.00 in to 6.00 in

Separately regulated in any stroke position: The hydraulic dampers of the product family DVC-32 and DVC-2 to DVC-6 are the first dampers to provide precise, independent, external adjustment of in-and-out speeds. With their individual adjustments for the push and pull direction as well as the bi-directional action, these are suitable as safety or control elements.

The great number of mounting accessories makes assembly of these ACE hydraulic dampers easier and allows these maintenance-free, ready-to-install and self-contained systems universally applicable. Qualitatively high grade, and at the same time simple to use; one of their uses is to absorb swinging loads.

These velocity controllers are used in the automotive sector, automation and machine building as well as in the electronics industry.

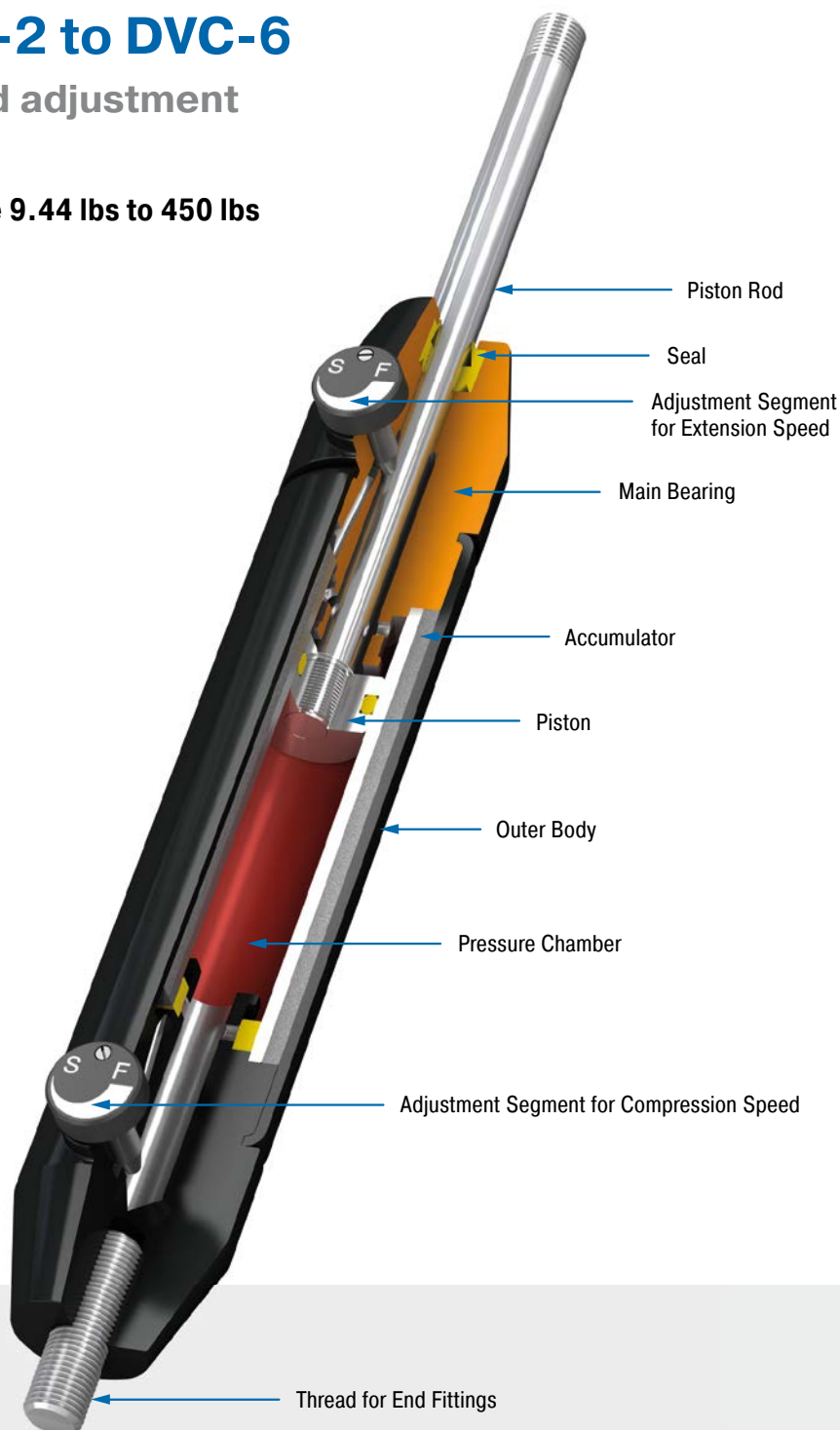

Technical Data

Compression and extension force:
9.44 lbs to 450 lbs

Outer body diameter: Ø 1.26 in

Piston rod diameter: Ø 0.31 in

Lifetime: Approx. 250,000 cycles

Operating temperature range: 32 °F to 149 °F

Adjustment: Steplessly adjustable

Positive stop: External positive stops 0.04 in to 0.06 in before the end of stroke provided by the customer.

Damping medium: Automatic Transmission Fluid (ATF)

Material: Outer body: Coated aluminium; Piston rod: Hard chrome plated steel; End fittings: Zinc plated steel

Mounting: In any position

Application field: Cylinder speed controls, Absorption control, Finishing and processing centers

Note: Increased break-away force if unit has not moved for some time. Damping force can be adjusted after installation.

End fittings: They are interchangeable and if necessary must be positively secured by the customer to prevent unscrewing.

On request: Special oils and other special options. Alternative accessories available on request.

Adjustable, Without Free Travel, Compression and extension force 9.44 lbs to 450 lbs

End Fitting

Standard Dimensions

End Fitting

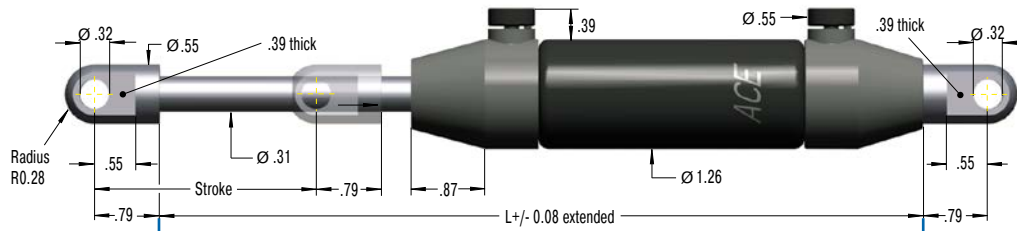
A8

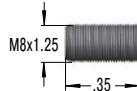
Eye A8
max. force 674 lbs

B8

Performance and Dimensions

| TYPES | Stroke inch | L extended inch | ¹ Compression force max. lbs |
|------------|----------------|--------------------|--|
| DVC-32-50 | 2.00 | 9.45 | 300 |
| DVC-32-100 | 4.00 | 13.39 | 350 |
| DVC-32-150 | 6.00 | 17.32 | 450 |

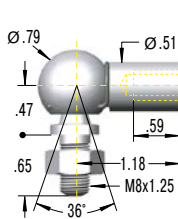
¹ Max. extension force for all stroke lengths 449.62 lbs.

Stud Thread B8
C8

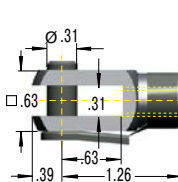
Angle Ball Joint C8
max. force 270 lbs
Also available with
UNF thread 5/16-18.
Order G5/16.

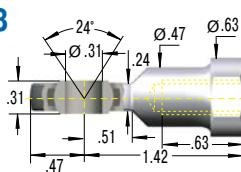
D8

Clevis Fork D8
max. force 674 lbs

E8

Swivel Eye E8
max. force 674 lbs

Ordering Example

DVC-32-50-DD-CCO

Type (Hydraulic Damper) _____
 Body Ø 1.26" (32 mm) omitted at DVC-2 to DVC-6 _____
 Stroke 2" (50 mm) _____
 Piston Rod End Fitting D8 _____
 Body End Fitting D8 _____
 Velocity Controls (Omit prefix for controlled, both directions) _____

Model Type Prefix

- : Controlled, both directions
 CCO: Controlled, compression only
 CTO: Controlled, tension only

End fittings: They are interchangeable and if necessary must be positively secured by the customer to prevent unscrewing.

Mounting accessories see from page 212.

DVC-2 to DVC-6

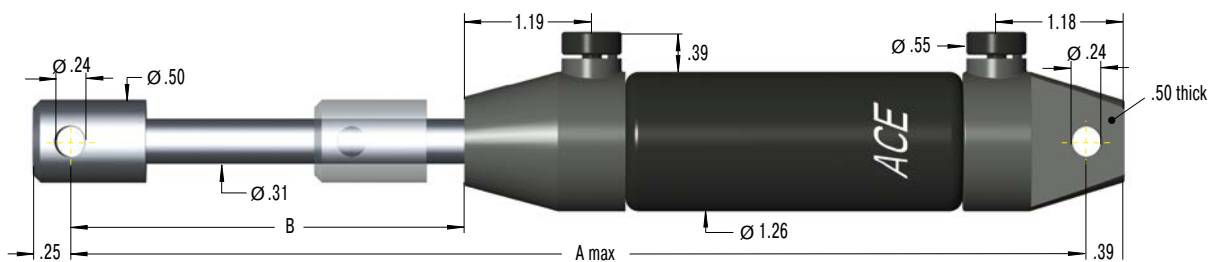

Performance and Dimensions

| TYPES | Stroke inch | A max. inch | B inch | Compression force max. lbs | Traction force max. lbs |
|-------|----------------|----------------|-----------|-------------------------------|----------------------------|
| DVC-2 | 2.00 | 9.81 | 2.96 | 450 | 450 |
| DVC-4 | 4.00 | 13.81 | 4.94 | 450 | 450 |
| DVC-6 | 6.00 | 17.81 | 6.94 | 450 | 450 |

HBD-15 to HBD-40

Regulation at the highest level

Adjustable

Compression and extension force 8 lbs to 2,248 lbs

Stroke 0.98 in to 31.5 in

ACE Controls HBD Hydraulic Dampers are maintenance-free, self-contained and sealed units. They are available with body diameters from 0.59" (15 mm) to 1.57" (40 mm) and with stroke lengths of up to 31.5" (800 mm). Unlike standard Hydraulic Dampers that include free travel up to 20 % of stroke, these dependable units have no free travel and are ideal for applications that require this level of performance. Double-acting Hydraulic Dampers are standard. However, a single acting design is available. Adjustment is easily achieved by pulling and turning the rod until the desired damping speed is achieved. The travel speed is adjustable and remains constant throughout the stroke.

The single acting version is controllable in one direction only, with free-flow in the opposite direction. A built-in antilock guard allows adjustment to be made at any damping rate without unit lock up. These reliable units offer long life-cycle performance. A variety of end fittings are available for ease of operation and installation, and are included.

HBD hydraulic dampers are used for process control, machine guards, lids, hatches, fire safety doors, arms for medical equipment, conveyors, swinging loads, machine tools, lift gates, drill feed control, amusement park rides, and more.

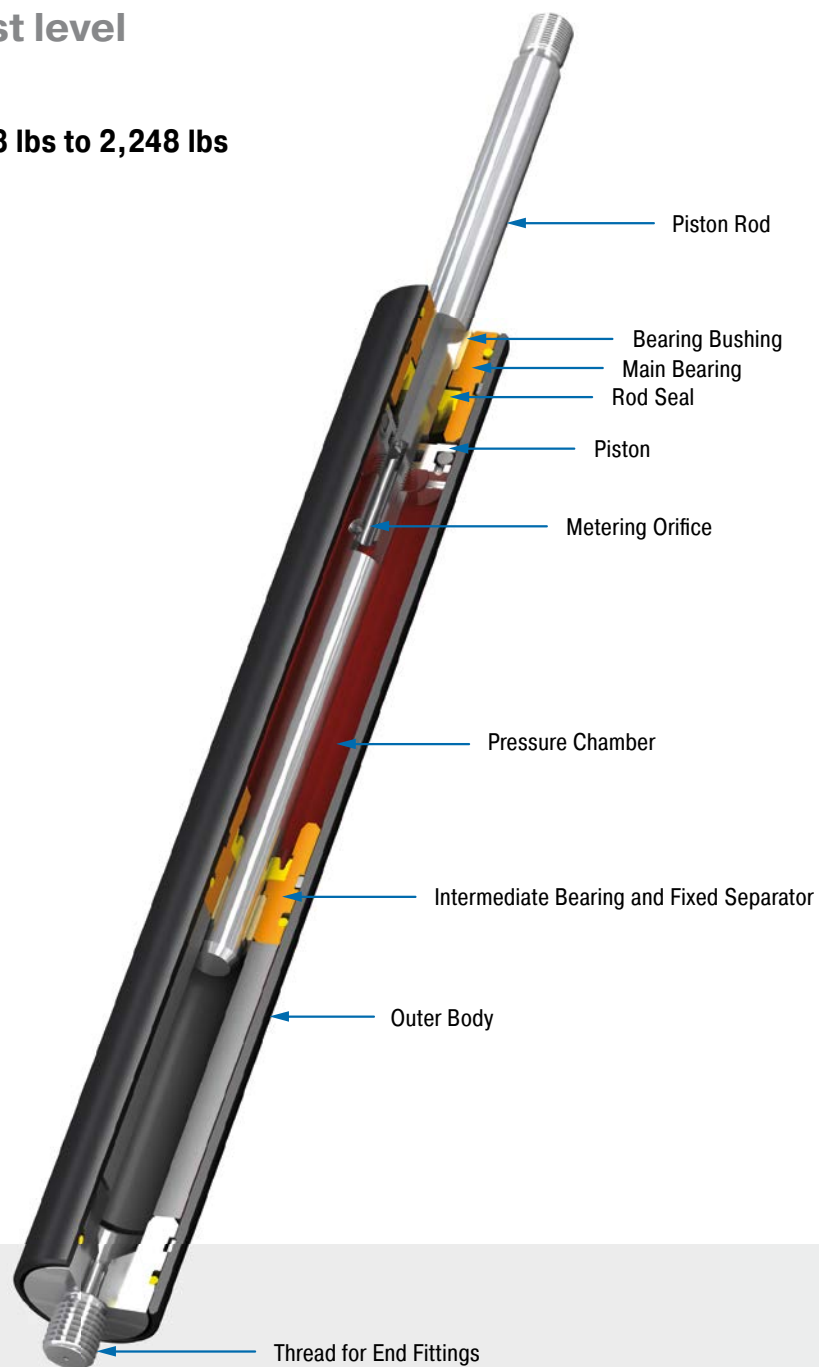

Technical Data

Compression and extension force: 8 lbs to 2,248 lbs

Outer body diameter: Ø 0.59 in to Ø 1.57 in

Piston rod diameter: Ø 0.24 in to Ø 0.55 in

Lifetime: Approx. 250,000 cycles

Free travel: These units have no free travel and are ideal for applications that require this level of performance.

Operating temperature range: -4 °F to 176 °F

Adjustment: Pull the piston rod out to its fully extended position. While pulling on the rod, turn it clockwise or counter-clockwise until the desired damping is achieved. The adjustment

is multi-turn and correct damping may require several trial and error adjustments. A built-in antilock guard allows adjustments to be made at any damping rate without unit lock up.

Positive stop: External positive stops 0.04 in to 0.06 in before the end of stroke provided by the customer.

Damping medium: Petroleum oil

Material: Outer body: Black anodized aluminium; Piston rod: Hard chrome plated steel; End fittings: Zinc plated steel

Mounting: In any position

Application field: Finishing and processing centers, Machine housing, Hoods, Shutters,

Fire safety doors, Medical technology, Conveyor systems, Swivel units, Tool machines, Lift doors

Note: Increased break-away force if unit has not moved for some time.

End fittings: They are interchangeable and if necessary must be positively secured by the customer to prevent unscrewing.

Safety information: Mechanical Stop required 0.04 in to 0.06 in before end of stroke.

On request: Special oils, damping characteristics, and stroke lengths. Alternative accessories available on request.

Adjustable, Compression and extension force 8 lbs to 180 lbs

End Fitting

Standard Dimensions

End Fitting

Performance and Dimensions

| TYPES | Stroke inch | L extended inch | ¹ Compression force max. lbs |
|------------|----------------|--------------------|--|
| HBD-15-25 | 0.98 | 5.71 | 179.85 |
| HBD-15-50 | 1.97 | 8.66 | 179.85 |
| HBD-15-75 | 2.95 | 11.61 | 179.85 |
| HBD-15-100 | 3.94 | 14.57 | 78.68 |
| HBD-15-150 | 5.91 | 20.47 | 67.44 |

¹ Max. extension force for all stroke lengths 180 lbs.

Ordering Example

HBD-15-150-AA-P

- Type (Hydraulic Damper)
- Body 0.59" (15 mm)
- Stroke 5.91" (150 mm)
- Piston Rod End Fitting A5
- Body End Fitting A5
- Damping Direction (P = in both directions)

Model Type Prefix

- P = Damping in both directions
- N = Damping on in stroke only
- M = Damping on out stroke only
- X = Special model suffix

Mounting accessories see from page 212.

Technical Data

Compression and extension force: 8 lbs to 180 lbs

Free travel: These units have no free travel and are ideal for applications that require this level of performance.

Operating temperature range: -4 °F to 176 °F

Adjustment: Pull the piston rod out to its fully extended position. While pulling on the rod, turn it clockwise or counter-clockwise until the desired damping is achieved. The adjustment is multi-turn and correct damping may require several trial and error adjustments. A built-in antilock guard allows adjustments to be made at any damping rate without unit lock up.

Positive stop: External positive stops 0.04 in to 0.06 in before the end of stroke provided by the customer.

Material: Outer body: Black anodized aluminium; Piston rod: Hard chrome plated steel; End fittings: Zinc plated steel

Mounting: In any position

Note: Increased break-away force if unit has not moved for some time.

End fittings: They are interchangeable and if necessary must be positively secured by the customer to prevent unscrewing.

Safety information: Mechanical Stop required 0.04 in to 0.06 in before end of stroke.

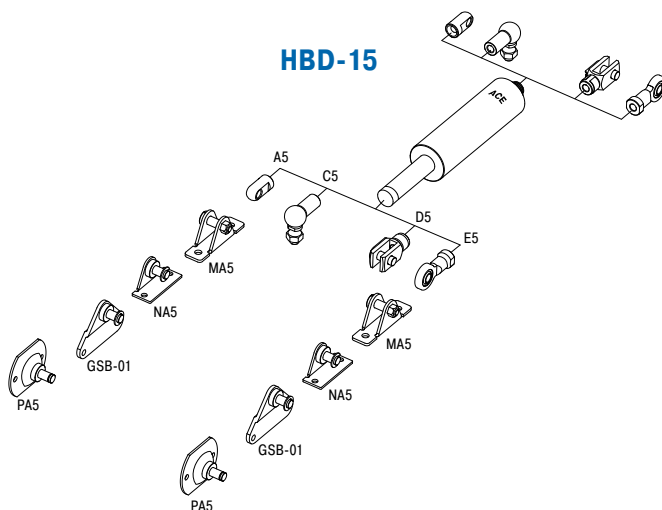

Adjustable, Compression and extension force 12 lbs to 405 lbs

End Fitting

Standard Dimensions

End Fitting

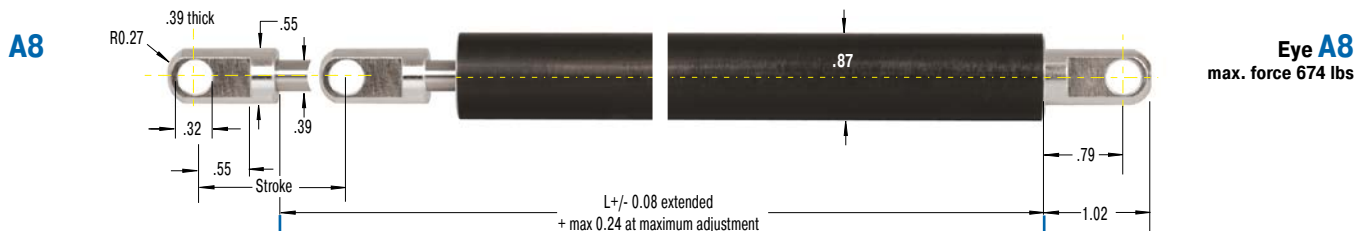

B8

C8

D8

E8

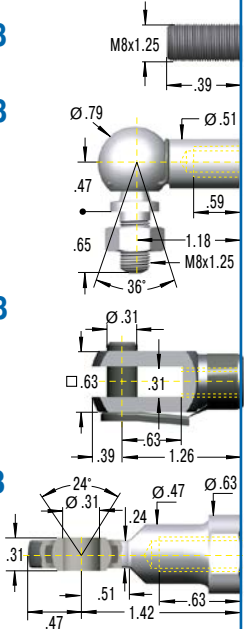

Eye A8
max. force 674 lbs

Stud Thread B8

Angle Ball Joint C8
max. force 270 lbs
Also available with
UNF thread 5/16-18.
Order G5/16.

Clevis Fork D8
max. force 674 lbs

Swivel Eye E8
max. force 674 lbs

Performance and Dimensions

| TYPES | Stroke inch | L extended inch | ¹ Compression force max. lbs |
|------------|----------------|--------------------|--|
| HBD-22-50 | 1.97 | 9.25 | 404.66 |
| HBD-22-100 | 3.94 | 15.16 | 404.66 |
| HBD-22-150 | 5.91 | 21.06 | 404.66 |
| HBD-22-200 | 7.87 | 26.97 | 224.81 |
| HBD-22-250 | 9.84 | 32.87 | 224.81 |
| HBD-22-300 | 11.81 | 38.78 | 179.85 |
| HBD-22-350 | 13.78 | 44.69 | 134.89 |
| HBD-22-400 | 15.75 | 50.59 | 89.92 |

¹ Max. extension force for all stroke lengths 405 lbs.

Ordering Example

HBD-22-150-AA-P

Type (Hydraulic Damper) _____
 Body 0.87" (22 mm) _____
 Stroke 5.90" (150 mm) _____
 Piston Rod End Fitting A8 _____
 Body End Fitting A8 _____
 Damping Direction (P = in both directions) _____

Model Type Prefix

- P = Damping in both directions
- N = Damping on in stroke only
- M = Damping on out stroke only
- X = Special model suffix

Mounting accessories see from page 212.

Technical Data

Compression and extension force: 12 lbs to 405 lbs

Free travel: These units have no free travel and are ideal for applications that require this level of performance.

Operating temperature range: -4 °F to 176 °F

Adjustment: Pull the piston rod out to its fully extended position. While pulling on the rod, turn it clockwise or counter-clockwise until the desired damping is achieved. The adjustment is multi-turn and correct damping may require several trial and error adjustments. A built-in antilock guard allows adjustments to be made at any damping rate without unit lock up.

Positive stop: External positive stops 0.04 in to 0.06 in before the end of stroke provided by the customer.

Material: Outer body: Black anodized aluminium; Piston rod: Hard chrome plated steel; End fittings: Zinc plated steel

Mounting: In any position

Note: Increased break-away force if unit has not moved for some time.

End fittings: They are interchangeable and if necessary must be positively secured by the customer to prevent unscrewing.

Safety information: Mechanical Stop required 0.04 in to 0.06 in before end of stroke.

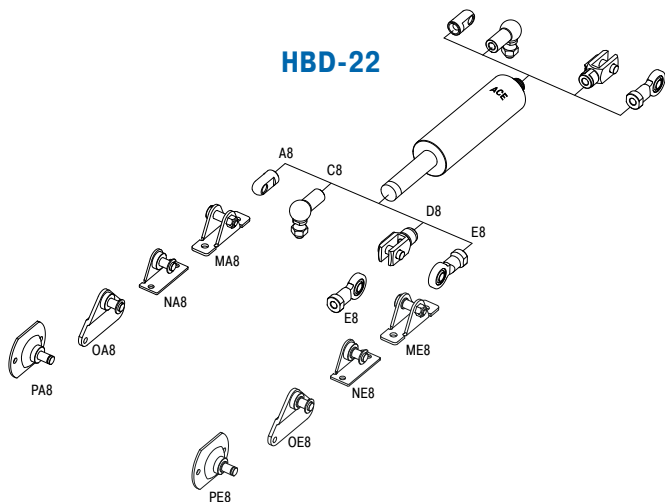

Adjustable, Compression and extension force 16 lbs to 674 lbs

End Fitting

Standard Dimensions

End Fitting

Performance and Dimensions

| TYPES | Stroke inch | L extended inch | ¹ Compression force max. lbs |
|------------|----------------|--------------------|--|
| HBD-28-50 | 1.97 | 9.85 | 674.43 |
| HBD-28-100 | 3.94 | 15.75 | 674.43 |
| HBD-28-150 | 5.91 | 21.66 | 674.43 |
| HBD-28-200 | 7.87 | 27.56 | 674.43 |
| HBD-28-250 | 9.84 | 33.47 | 674.43 |
| HBD-28-300 | 11.81 | 39.37 | 562.03 |
| HBD-28-350 | 13.78 | 45.28 | 449.62 |
| HBD-28-400 | 15.75 | 51.19 | 337.22 |
| HBD-28-500 | 19.69 | 63.00 | 224.81 |

¹ Max. extension force for all stroke lengths 674 lbs.

Ordering Example

HBD-28-150-AA-P

Type (Hydraulic Damper) _____
 Body 1.10" (28 mm) _____
 Stroke 5.91" (150 mm) _____
 Piston Rod End Fitting A8 _____
 Body End Fitting A8 _____
 Damping Direction (P = in both directions) _____

Model Type Prefix

P = Damping in both directions
 N = Damping on in stroke only
 M = Damping on out stroke only
 X = Special model suffix

Mounting accessories see from page 212.

End Fitting Options:
 Eye **A8** max. force 674 lbs
 Stud Thread **B8**
 Angle Ball Joint **C8** max. force 270 lbs
 Also available with UNF thread 5/16-18. Order G5/16.
 Clevis Fork **D8** max. force 674 lbs
 Swivel Eye **E8** max. force 674 lbs

Technical Data

Compression and extension force: 16 lbs to 674 lbs

Free travel: These units have no free travel and are ideal for applications that require this level of performance.

Operating temperature range: -4 °F to 176 °F

Adjustment: Pull the piston rod out to its fully extended position. While pulling on the rod, turn it clockwise or counter-clockwise until the desired damping is achieved. The adjustment is multi-turn and correct damping may require several trial and error adjustments. A built-in antilock guard allows adjustments to be made at any damping rate without unit lock up.

Positive stop: External positive stops 0.04 in to 0.06 in before the end of stroke provided by the customer.

Material: Outer body: Black anodized aluminium; Piston rod: Hard chrome plated steel; End fittings: Zinc plated steel

Mounting: In any position

Note: Increased break-away force if unit has not moved for some time.

End fittings: They are interchangeable and if necessary must be positively secured by the customer to prevent unscrewing.

Safety information: Mechanical Stop required 0.04 in to 0.06 in before end of stroke.

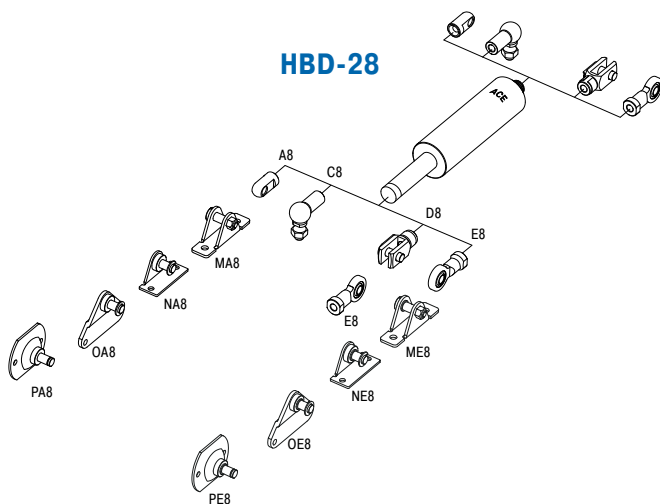

Issue 04.2018 – Specifications subject to change

Adjustable, Compression and extension force 18 lbs to 2,248 lbs

End Fitting

Standard Dimensions

End Fitting

Performance and Dimensions

| TYPES | Stroke inch | L extended inch | ¹ Compression force max. lbs |
|------------|----------------|--------------------|--|
| HBD-40-100 | 3.94 | 16.93 | 2,248.10 |
| HBD-40-150 | 5.91 | 22.83 | 2,248.10 |
| HBD-40-200 | 7.87 | 28.74 | 2,248.10 |
| HBD-40-300 | 11.81 | 40.55 | 2,248.10 |
| HBD-40-400 | 15.75 | 52.36 | 1,798.48 |
| HBD-40-500 | 19.69 | 64.17 | 1,348.86 |
| HBD-40-600 | 23.62 | 75.98 | 899.24 |
| HBD-40-700 | 27.56 | 87.80 | 674.43 |
| HBD-40-800 | 31.50 | 99.61 | 449.62 |

¹ Max. extension force for all stroke lengths 2,248 lbs.

Ordering Example

HBD-40-300-AA-P

Type (Hydraulic Damper) _____
 Body 1.57" (40 mm) _____
 Stroke 11.81" (300 mm) _____
 Piston Rod End Fitting A14 _____
 Body End Fitting A14 _____
 Damping Direction (P = in both directions) _____

Model Type Prefix

P = Damping in both directions
 N = Damping on in stroke only
 M = Damping on out stroke only
 X = Special model suffix

Mounting accessories see from page 212.

Technical Data

Compression and extension force: 18 lbs to 2,248 lbs

Free travel: These units have no free travel and are ideal for applications that require this level of performance.

Operating temperature range: -4 °F to 176 °F

Adjustment: Pull the piston rod out to its fully extended position. While pulling on the rod, turn it clockwise or counter-clockwise until the desired damping is achieved. The adjustment is multi-turn and correct damping may require several trial and error adjustments. A built-in antilock guard allows adjustments to be made at any damping rate without unit lock up.

Positive stop: External positive stops 0.04 in to 0.06 in before the end of stroke provided by the customer.

Material: Outer body: Black anodized aluminium; Piston rod: Hard chrome plated steel; End fittings: Zinc plated steel

Mounting: In any position

Note: Increased break-away force if unit has not moved for some time.

End fittings: They are interchangeable and if necessary must be positively secured by the customer to prevent unscrewing.

Safety information: Mechanical Stop required 0.04 in to 0.06 in before end of stroke.

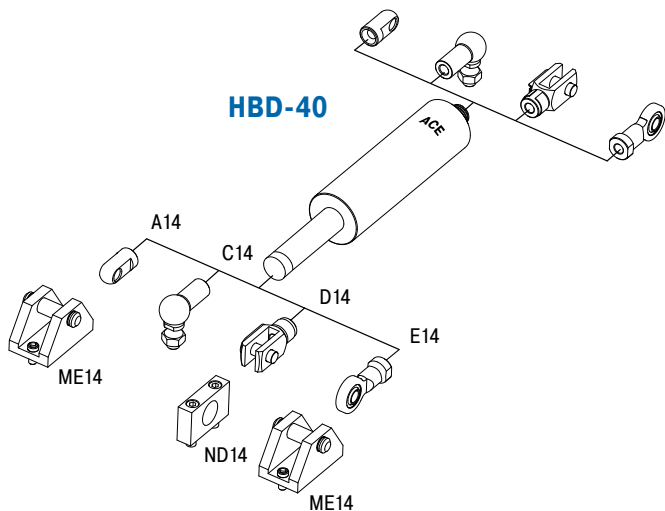

Dream it

We. Love. Challenges.



Ok, pure gold or fur-covered are not realistic options.
But if you need a perfect solution for your individual needs, ACE has the tools and expertise to make it happen.

Call our experts
+1 800-521-3220 or go to **www.acecontrols.com**

HB-12 to HB-70

Linear motion control

Adjustable

Compression and extension force 4 lbs to 11,240 lbs

Stroke 0.98 in to 31.50 in

High quality and long service life: The hydraulic dampers of the product family HB can also be used as single or double acting brake. Its coated body and piston rods with wear-resistant surface treatment are features of high quality and long service life.

The maintenance free, ready-to-install and closed systems provide a constant feed rate and are adjustable. The control segment on the piston makes adjustment at the end position child's play. Thanks to a broad selection of end fittings the assembly is easy to mount, so that the damper can be universally deployed for damping swinging masses, such as in power or free conveyors.

On automotive, automation and machine building, medical technology or the electronics and furniture industry, these machine elements are found in a number of different areas.

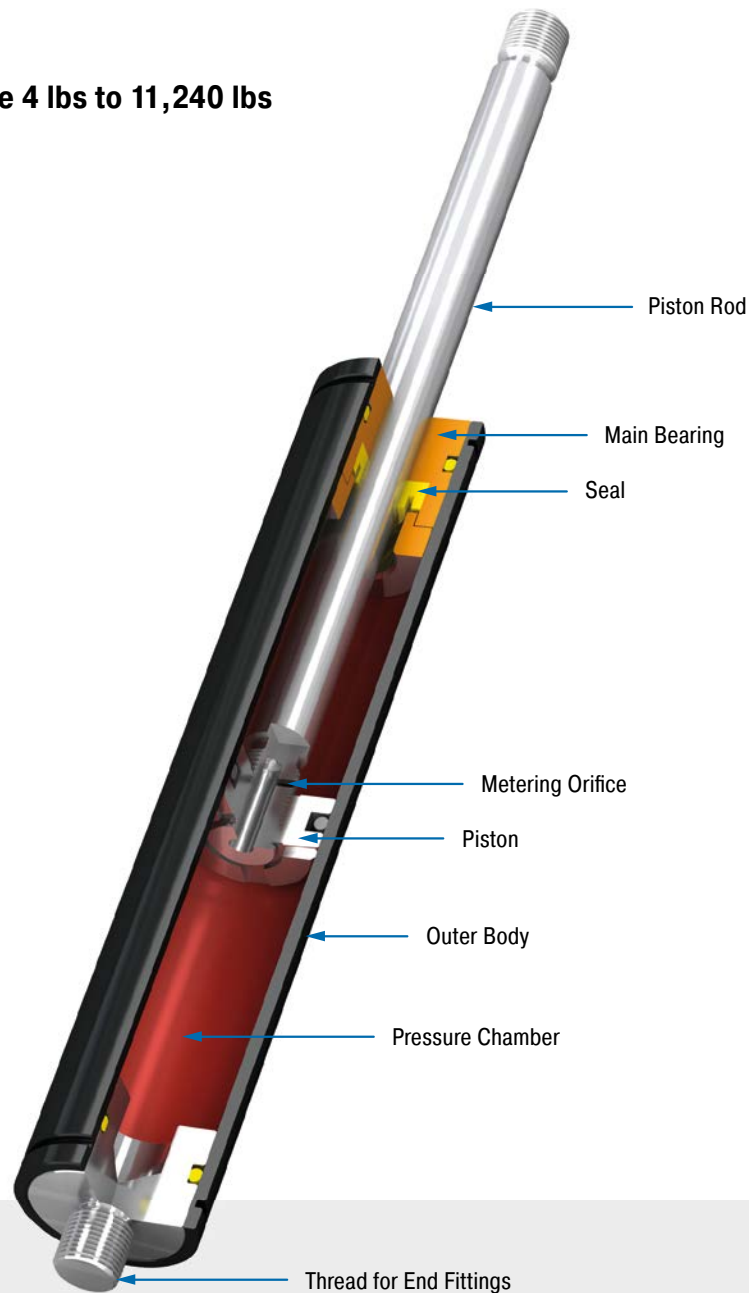

Technical Data

Compression and extension force: 4 lbs to 11,240 lbs

Outer body diameter: Ø 0.47 in to Ø 2.76 in

Piston rod diameter: Ø 0.16 in to Ø 1.18 in

Lifetime: Approx. 250,000 cycles

Free travel: Construction of the damper results in a free travel of approx. 20 % of stroke.

Separator piston: Available as a special option without free travel achieved by separator piston and nitrogen accumulator.

Operating temperature range: -4 °F to 176 °F

Adjustment: Achieved by turning the piston rod in its fully extended or fully compressed position.

Positive stop: External positive stops 0.04 in to 0.24 in before the end of stroke provided by the customer.

Damping medium: Hydraulic oil

Material: Outer body: Coated steel; Piston rod: Steel or stainless steel with wear-resistant coating; End fittings: Zinc plated steel

Mounting: In any position

Application field: Conveyor systems, Transport systems, Furniture industry, Locking systems, Sports equipment

Note: Increased break-away force if unit has not moved for some time.

End fittings: They are interchangeable and if necessary must be positively secured by the customer to prevent unscrewing.

On request: Special oils and other special options. Alternative accessories available on request.

Adjustable, Compression and extension force 4 lbs to 40 lbs

End Fitting

Standard Dimensions

End Fitting

A3.5

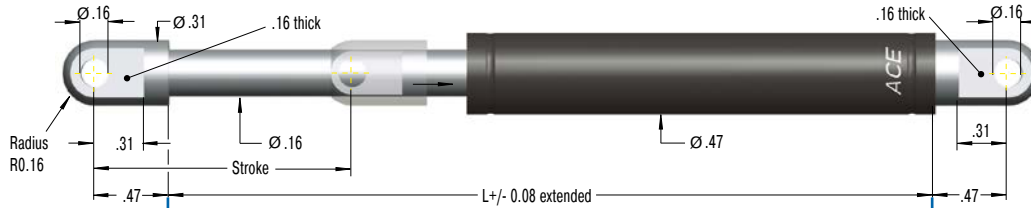

Eye A3.5
max. force 83 lbs

B3.5

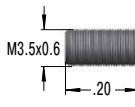

Performance and Dimensions

| TYPES | Stroke inch | L extended inch | ¹ Compression force max. lbs |
|----------|----------------|--------------------|--|
| HB-12-10 | 0.39 | 2.17 | 40.47 |
| HB-12-20 | 0.79 | 2.95 | 40.47 |
| HB-12-30 | 1.18 | 3.74 | 40.47 |
| HB-12-40 | 1.57 | 4.53 | 40.47 |
| HB-12-50 | 1.97 | 5.31 | 40.47 |
| HB-12-60 | 2.36 | 6.10 | 40.47 |
| HB-12-70 | 2.76 | 6.89 | 40.47 |
| HB-12-80 | 3.15 | 7.68 | 33.72 |

¹ Max. extension force for all stroke lengths 40 lbs.

Stud Thread B3.5

C3.5

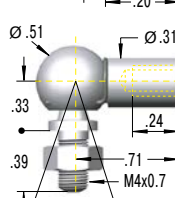

Angle Ball Joint C3.5
max. force 83 lbs

D3.5

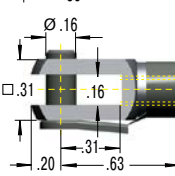

Clevis Fork D3.5
max. force 83 lbs

E3.5

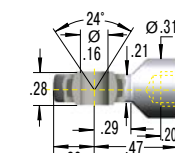

Swivel Eye E3.5
max. force 83 lbs

G3.5

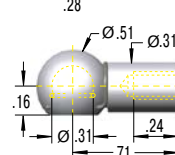

Ball Socket G3.5
max. force 83 lbs

Ordering Example

HB-12-30-AC-M

Type (Hydraulic Damper) _____
 Body 0.47" (12 mm) _____
 Stroke 1.18" (30 mm) _____
 Piston Rod End Fitting A3.5 _____
 Body End Fitting C3.5 _____
 Damping Direction (M = out stroke only) _____

Model Type Prefix

P: Damping in both directions
 N: Damping on in stroke only
 M: Damping on out stroke only
 X: Special model suffix

Mounting accessories see from page 212.

Rod Shroud W3.5-12

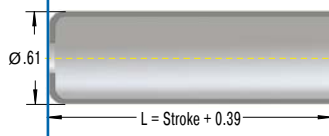

Technical Data

Compression and extension force: 4 lbs to 40 lbs

Free travel: Construction of the damper results in a free travel of approx. 21 % of stroke.

Separator piston: Available as a special option without free travel achieved by separator piston and nitrogen accumulator.

Operating temperature range: -4 °F to 176 °F

Adjustment: Achieved by turning the piston rod in its fully extended or fully compressed position.

Clockwise rotation = increase of the damping

Anti-clockwise rotation = decrease of the damping

Damping force adjustable before installation. Adjustment can add a max. of 0.24 in to the L dimension.

Positive stop: External positive stops 0.04" to 0.06" before the end of stroke provided by the customer.

Material: Outer body: Coated steel; Piston rod: Stainless steel (1.4301/1.4305, AISI 304/303); End fittings: Zinc plated steel

Mounting: In any position

Note: Increased break-away force if unit has not moved for some time.

End fittings: They are interchangeable and if necessary must be positively secured by the customer to prevent unscrewing.

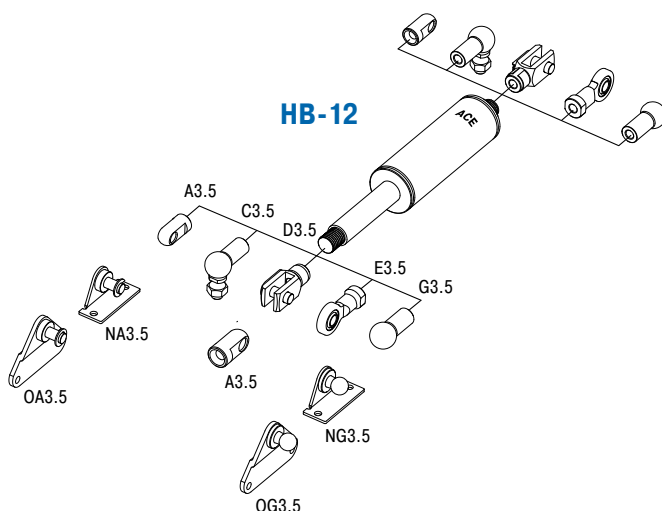

Adjustable, Compression and extension force 4 lbs to 180 lbs

End Fitting

Standard Dimensions

End Fitting

Performance and Dimensions

| TYPES | Stroke inch | L extended inch | ¹ Compression force max. lbs |
|-----------|----------------|--------------------|--|
| HB-15-25 | 0.98 | 3.54 | 179.85 |
| HB-15-50 | 1.97 | 5.51 | 179.85 |
| HB-15-75 | 2.95 | 7.48 | 179.85 |
| HB-15-100 | 3.94 | 9.5 | 78.68 |
| HB-15-150 | 5.91 | 13.39 | 67.44 |

¹ Max. extension force for all stroke lengths 180 lbs.

Ordering Example

HB-15-150-AA-P

Type (Hydraulic Damper) _____
 Body 0.59" (15 mm) _____
 Stroke 5.91" (150 mm) _____
 Piston Rod End Fitting A5 _____
 Body End Fitting A5 _____
 Damping Direction (P = in both directions) _____

Model Type Prefix

P: Damping in both directions
 N: Damping on in stroke only
 M: Damping on out stroke only
 X: Special model suffix

Mounting accessories see from page 212.

Technical Data

Compression and extension force: 4 lbs to 180 lbs

Free travel: Construction of the damper results in a free travel of approx. 20 % of stroke.

Separator piston: Available as a special option without free travel achieved by separator piston and nitrogen accumulator.

Operating temperature range: -4 °F to 176 °F

Adjustment: Achieved by turning the piston rod in its fully extended or fully compressed position.

Clockwise rotation = increase of the damping

Anti-clockwise rotation = decrease of the damping

Damping force adjustable before installation. Adjustment can add a max. of 0.24 in to the L dimension.

Positive stop: External positive stops 0.04" to 0.06" before the end of stroke provided by the customer.

Material: Outer body: Black anodized aluminium; Piston rod: Steel with wear-resistant coating; End fittings: Zinc plated steel

Mounting: In any position

Note: Increased break-away force if unit has not moved for some time.

End fittings: They are interchangeable and if necessary must be positively secured by the customer to prevent unscrewing.

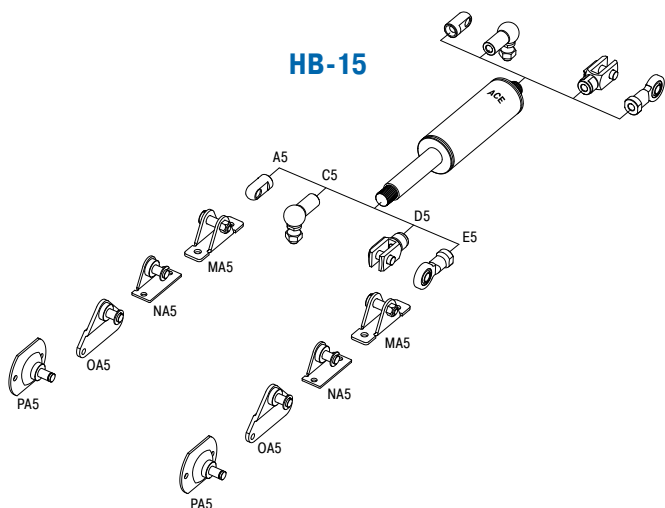

Adjustable, Compression and extension force 7 lbs to 405 lbs

End Fitting

Standard Dimensions

End Fitting

End Fitting A8
max. force 674 lbs

Eye A8
max. force 674 lbs

Stud Thread B8

Angle Ball Joint C8
max. force 270 lbs
Also available with UNF thread 5/16-18. Order G5/16.

Clevis Fork D8
max. force 674 lbs

Swivel Eye E8
max. force 674 lbs

Performance and Dimensions

| TYPES | Stroke inch | L extended inch | ¹ Compression force max. lbs |
|-----------|-------------|-----------------|---|
| HB-22-50 | 1.97 | 5.90 | 404.66 |
| HB-22-100 | 3.94 | 9.84 | 404.66 |
| HB-22-150 | 5.91 | 13.78 | 404.66 |
| HB-22-200 | 7.87 | 17.72 | 224.81 |
| HB-22-250 | 9.84 | 21.65 | 224.81 |
| HB-22-300 | 11.81 | 25.58 | 179.85 |
| HB-22-350 | 13.78 | 29.52 | 134.89 |
| HB-22-400 | 15.75 | 33.46 | 89.92 |

¹ Max. extension force for all stroke lengths 405 lbs.

Ordering Example

HB-22-150-AA-P

Type (Hydraulic Damper) _____
 Body 0.87" (22 mm) _____
 Stroke 5.90" (150 mm) _____
 Piston Rod End Fitting A8 _____
 Body End Fitting A8 _____
 Damping Direction (P = in both directions) _____

Model Type Prefix

P: Damping in both directions
 N: Damping on in stroke only
 M: Damping on out stroke only
 X: Special model suffix

Mounting accessories see from page 212.

Technical Data

Compression and extension force: 7 lbs to 405 lbs

Free travel: Construction of the damper results in a free travel of approx. 20 % of stroke.

Separator piston: Available as a special option without free travel achieved by separator piston and nitrogen accumulator.

Operating temperature range: -4 °F to 176 °F

Adjustment: Achieved by turning the piston rod in its fully extended or fully compressed position.

Clockwise rotation = increase of the damping

Anti-clockwise rotation = decrease of the damping

Damping force adjustable before installation. Adjustment can add a max. of 0.24 in to the L dimension.

Positive stop: External positive stops 0.04" to 0.06" before the end of stroke provided by the customer.

Material: Outer body: Black anodized aluminium; Piston rod: Steel with wear-resistant coating; End fittings: Zinc plated steel

Mounting: In any position

Note: Increased break-away force if unit has not moved for some time.

End fittings: They are interchangeable and if necessary must be positively secured by the customer to prevent unscrewing.

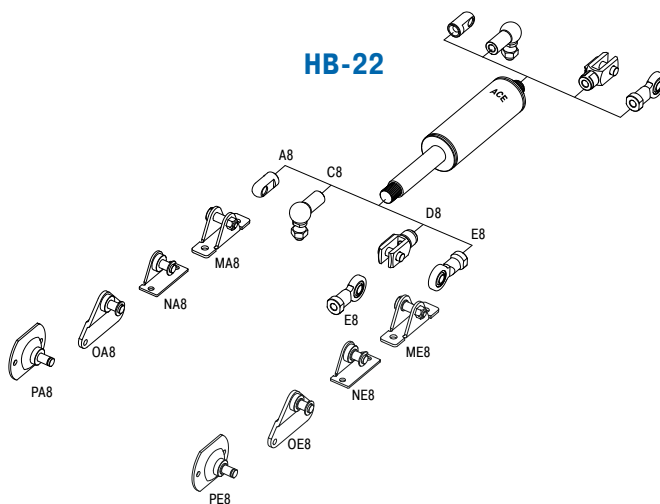

Adjustable, Compression and extension force 7 lbs to 674 lbs

End Fitting

Standard Dimensions

End Fitting

Performance and Dimensions

| TYPES | Stroke inch | L extended inch | ¹ Compression force max. lbs |
|-----------|----------------|--------------------|--|
| HB-28-50 | 1.97 | 6.30 | 674.43 |
| HB-28-100 | 3.94 | 10.24 | 674.43 |
| HB-28-150 | 5.91 | 14.17 | 674.43 |
| HB-28-200 | 7.87 | 18.11 | 674.43 |
| HB-28-250 | 9.84 | 22.05 | 674.43 |
| HB-28-300 | 11.81 | 25.98 | 562.03 |
| HB-28-350 | 13.78 | 29.92 | 449.62 |
| HB-28-400 | 15.75 | 33.86 | 337.22 |
| HB-28-500 | 19.69 | 41.73 | 224.81 |

¹ Max. extension force for all stroke lengths 674 lbs.

Ordering Example

HB-28-150-AA-P

Type (Hydraulic Damper) _____
 Body 1.10" (28 mm) _____
 Stroke 5.91" (150 mm) _____
 Piston Rod End Fitting A8 _____
 Body End Fitting A8 _____
 Damping Direction (P = in both directions) _____

Model Type Prefix

P: Damping in both directions
 N: Damping on in stroke only
 M: Damping on out stroke only
 X: Special model suffix

Mounting accessories see from page 212.

Technical Data

Compression and extension force: 7 lbs to 674 lbs

Free travel: Construction of the damper results in a free travel of approx. 20 % of stroke.

Separator piston: Available as a special option without free travel achieved by separator piston and nitrogen accumulator.

Operating temperature range: -4 °F to 176 °F

Adjustment: Achieved by turning the piston rod in its fully extended or fully compressed position.

Clockwise rotation = increase of the damping

Anti-clockwise rotation = decrease of the damping

Damping force adjustable before installation. Adjustment can add a max. of 0.24 in to the L dimension.

Positive stop: External positive stops 0.04" to 0.06" before the end of stroke provided by the customer.

Material: Outer body: Black anodized aluminium; Piston rod: Steel with wear-resistant coating; End fittings: Zinc plated steel

Mounting: In any position

Note: Increased break-away force if unit has not moved for some time.

End fittings: They are interchangeable and if necessary must be positively secured by the customer to prevent unscrewing.

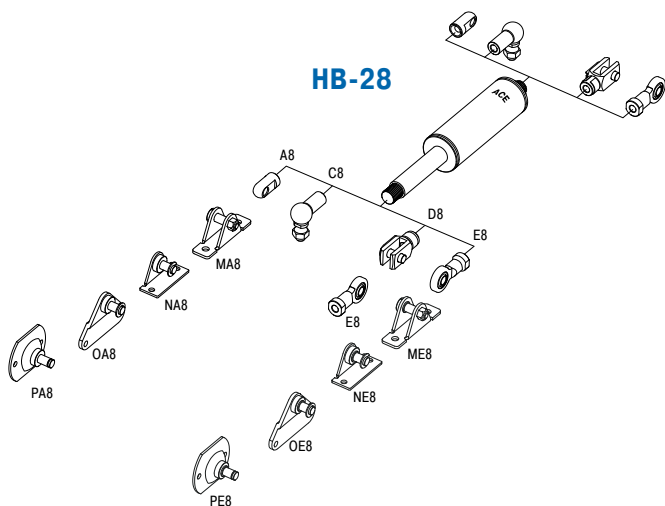

Adjustable, Compression and extension force 450 lbs to 11,241 lbs

End Fitting

Standard Dimensions

End Fitting

B24 Stud Thread **B24**

D24 Clevis Fork **D24** max. force 11,240 lbs

E24 Swivel Eye **E24** max. force 11,240 lbs

Rod Shroud W24-70 Ø 3.15 L = Stroke + 5.12

Performance and Dimensions

| TYPES | Stroke inch | L extended inch | ¹ Compression force max. lbs |
|-----------|-------------|-----------------|---|
| HB-70-100 | 4.37 | 13.03 | 11,240 |
| HB-70-200 | 8.31 | 20.91 | 11,240 |
| HB-70-300 | 12.24 | 28.78 | 11,240 |
| HB-70-400 | 16.18 | 36.65 | 6,812 |
| HB-70-500 | 20.12 | 44.53 | 4,856 |
| HB-70-600 | 24.06 | 52.40 | 3,642 |
| HB-70-700 | 27.99 | 60.28 | 2,833 |
| HB-70-800 | 31.93 | 68.15 | 2,271 |

¹ Max. extension force for all stroke lengths 11,241 lbs.

Ordering Example **HB-70-300-EE-N**

Type (Hydraulic Damper) _____
 Body 2.76" (70 mm) _____
 Stroke 11.81" (300 mm) _____
 Piston Rod End Fitting E24 _____
 Body End Fitting E24 _____
 Damping Direction (N = in stroke only) _____

Model Type Prefix
 P: Damping in both directions
 N: Damping on in stroke only
 M: Damping on out stroke only
 X: Special model suffix

Mounting accessories see from page 212.

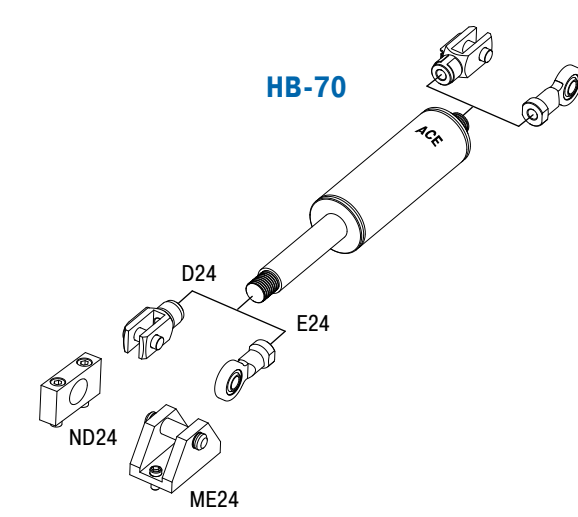

Technical Data

- Compression and extension force:** 450 lbs to 11,241 lbs
- Free travel:** Construction of the damper results in a free travel of approx. 20 % of stroke.
- Separator piston:** Available as a special option without free travel achieved by separator piston and nitrogen accumulator.
- Operating temperature range:** -4 °F to 176 °F
- Adjustment:** Achieved by turning the piston rod in its fully extended or fully compressed position.
- Positive stop:** External positive stops 0.20" to 0.24" before the end of stroke provided by the customer.
- Material:** Outer body: Coated steel; Piston rod: Hard chrome plated steel; End fittings: Zinc plated steel
- Mounting:** In any position
- Note:** Increased break-away force if unit has not moved for some time.
- End fittings:** They are interchangeable and if necessary must be positively secured by the customer to prevent unscrewing.

ACE Digital Tools



For more information
about the calculation
service see page 188!

Print catalog? Everyone can.

ACE offers more:

- ▶ Downloads: Product information in many languages
- ▶ PC calculation software & online calculation service
- ▶ Extensive CAD component libraries
- ▶ ACE-YouTube channel with video tips
- ▶ VibroChecker – free award-winning iPhone App

All available at www.acecontrols.com

Application Examples

DVC-32

Precise unreeling

Hydraulic dampers bring the sled movement of this textile machine to a gentle stop. At the turning point of 287 lbs reeling spools, a sled should move up and down smoothly without causing a collision at the end of stroke position. The solution was provided by the hydraulic damper DVC-32-100. A self-contained sealed unit, ready to install and maintenance-free these units are ideal for precise control of speeds in both directions of travel. The travel speed is maintained throughout the entire stroke and can be independently adjusted in each direction of travel. Thanks to their compact design and wide choice of mounting accessories, these dampers could be easily integrated into this machine.

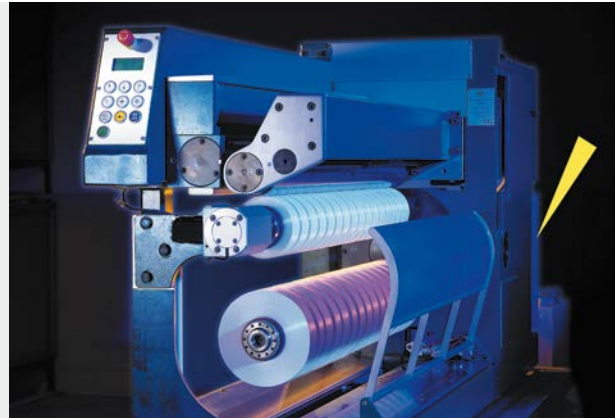
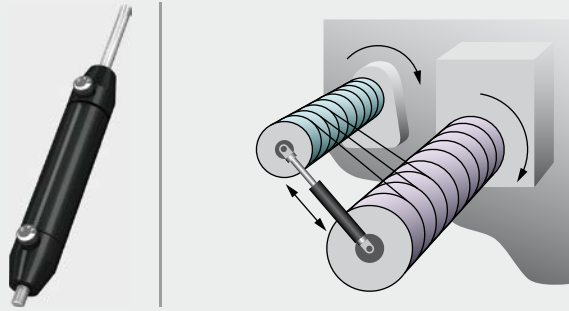

Textile machine unreels threads even better

HB-15

Operating speed of flaps top-regulated

In the past, operators of used-clothes containers could sustain injury because the flaps closed relatively quickly and uncontrollably. Various hydraulic dampers of the type HB-15, which are designed specifically for the type of container, regulate the synchronization of the flap in both directions and thereby serve to regulate the operating speed. To accommodate a range of requirements and to provide optimal protection against theft, different types with different strokes are mounted on flaps without damping, on large flaps with damping and on rotor flaps with damping.

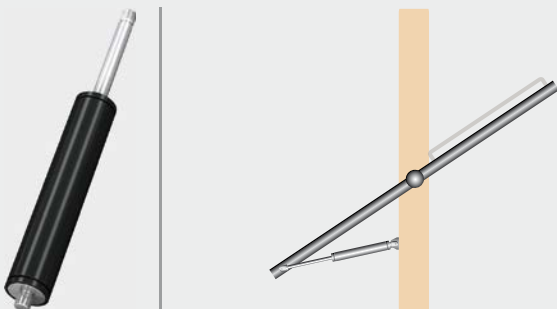

Hydraulic dampers prevent fingers becoming trapped in used-clothes containers as they ensure more gentle opening and closing movements
MCB Milieu & Techniek BV, 4704 SE Roosendaal, Netherlands

HB-40

Swinging movements cushioned by hydraulic dampers

Passengers always feel the swinging movement involved when cable cars arrive at the ski station. Maintenance-free hydraulic dampers type HB-40-300 cushion these movements perfectly. Designers of the cable cars, connected by means of an articulated joint via a four-point frame and connection guide to the suspension rod, profit from the ability of the adjustable dampers to absorb compressive forces of up to 2,248 lbs on either side.



Hydraulic dampers for added convenience when operating cable cars

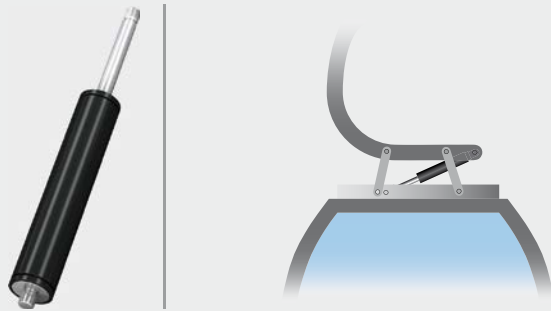

Mounting Accessories for steel gas springs and hydraulic dampers

By taking advantage of the very extensive range of ACE end fittings and mounting brackets you can easily and simply install our gas springs and hydraulic dampers. You profit from the variety of DIN standard end fittings such as swivel eyes, clevis forks, angle ball joints, inline ball joints, and included ball sockets.

ACE also offers eye fittings made of wear-resistant steel to meet the higher specification requirements found in industrial applications. With over 30 different types available these mounting accessories provide an extensive range of combinations for optimum installations.

With the ACE selection program you can choose not only your ACE gas springs but also the ideal end fittings and mounting brackets for your individual application example.

The complete range of accessories are also available as individual components.

**Infinite
Combinations!**

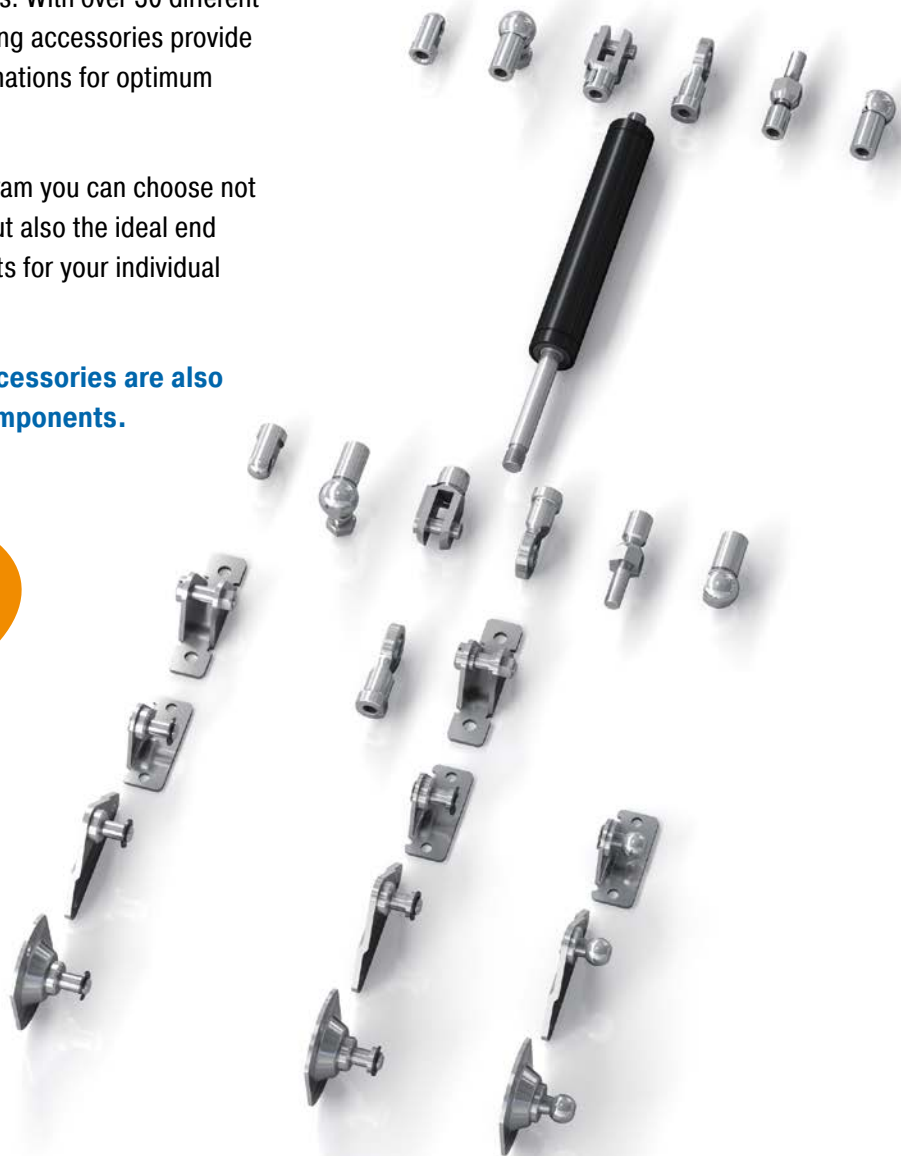

M3.5x0.6 (for GS-8, GS-10, GS-12, GZ-15, HB-12)

C3.5

Angle Ball Joint
DIN 71802

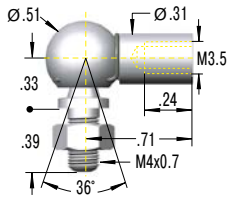

¹ max. force 83 lbs

E3.5

Swivel Eye
DIN 648

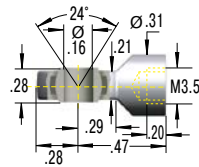

¹ max. force 83 lbs

A3.5

Eye

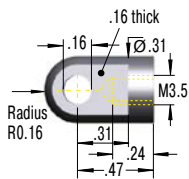

¹ max. force 83 lbs

NA3.5

Angle Bracket

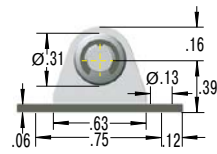

¹ max. force 40 lbs

OA3.5

Side Bracket

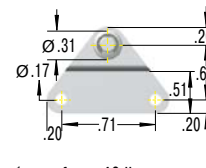
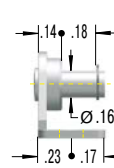

¹ max. force 40 lbs

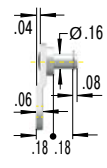

D3.5

Clevis Fork
DIN 71752

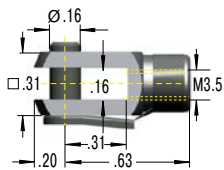

¹ max. force 83 lbs

A3.5

Eye

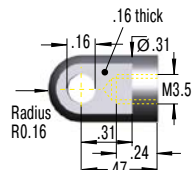

¹ max. force 83 lbs

G3.5

Ball Socket
DIN 71805

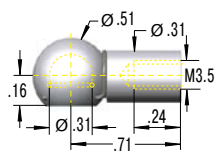

¹ max. force 83 lbs

NG3.5

Angle Bracket

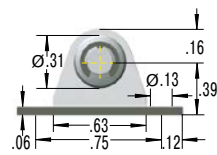

¹ max. force 40 lbs

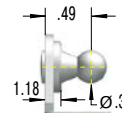

OG3.5

Side Bracket

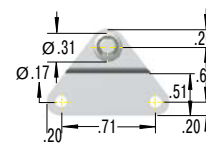

¹ max. force 40 lbs

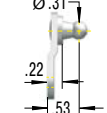

¹ Attention! Max. static load in Newtons. Beware force increase during compression (progression) and observe max. force limit.

M5x0.8 (for GS-15, HBD-15, HB-15)

C5
Angle Ball Joint
DIN 71802

¹ max. force 112 lbs

D5
Clevis Fork
DIN 71752

¹ max. force 180 lbs

F5
Inline Ball Joint

¹ max. force 112 lbs
Attention! Must only be used with compression loads.

A5
Eye

¹ max. force 180 lbs

MA5
Bearing Shoe

¹ max. force 112 lbs

NA5
Angle Bracket

¹ max. force 90 lbs

E5
Swivel Eye
DIN 648

¹ max. force 180 lbs



GSB-01
Side Bracket

¹ max. force 112 lbs

PA5
Round Bracket

¹ max. force 112 lbs

G5
Ball Socket
DIN 71805

¹ max. force 112 lbs



NG5
Angle Bracket

¹ max. force 90 lbs

GSB-02
Side Bracket

¹ max. force 112 lbs

PG5
Round Bracket

¹ max. force 112 lbs

¹ Attention! Max. static load in Newtons. Beware force increase during compression (progression) and observe max. force limit.

M8x1.25

(for GS-19, GS-22, GZ-19, HBD-22, HBD-28, HB-22, HB-28, DVC-32)

C8

Angle Ball Joint
DIN 71802

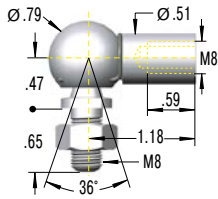

¹ max. force 270 lbs
Also available with UNF thread 5/16-18.
Order G5/16.

F8

Inline Ball Joint

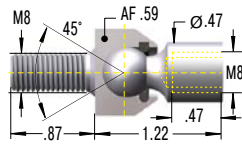

¹ max. force 270 lbs
Attention! Must only be used
with compression loads.

A8

Eye

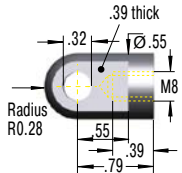

¹ max. force 674 lbs

MA8

Bearing Shoe

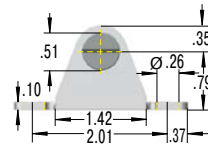

¹ max. force 405 lbs

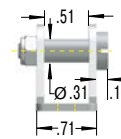

NA8

Angle Bracket

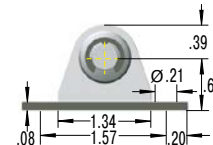

¹ max. force 225 lbs

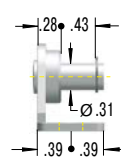

OA8

Side Bracket

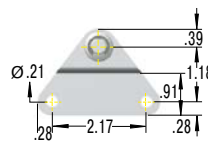

¹ max. force 270 lbs

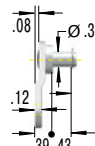

PA8

Round Bracket

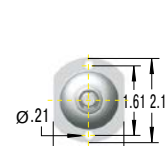

¹ max. force 270 lbs

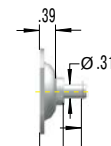

D8

Clevis Fork
DIN 71752

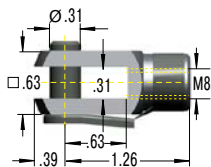

¹ max. force 674 lbs



E8

Swivel Eye
DIN 648

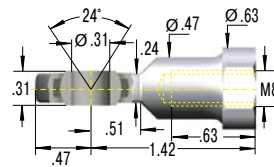

¹ max. force 674 lbs

¹ Attention! Max. static load in Newtons. Beware force increase during compression (progression) and observe max. force limit.

M8x1.25 (for GS-19, GS-22, GZ-19, HBD-22, HBD-28, HB-22, HB-28, DVC-32)

E8
Swivel Eye
DIN 648

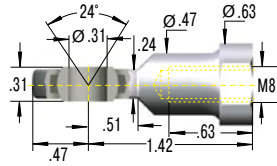

¹ max. force 674 lbs



ME8
Bearing Shoe

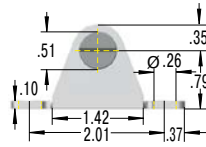

¹ max. force 405 lbs

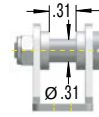

NE8
Angle Bracket

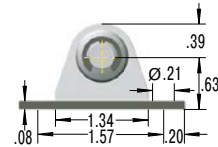

¹ max. force 225 lbs

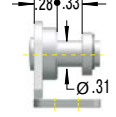

OE8
Side Bracket

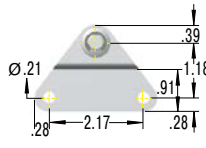

¹ max. force 270 lbs

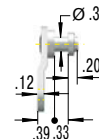

PE8
Round Bracket

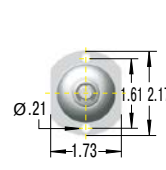

¹ max. force 270 lbs

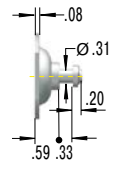

G8
Ball Socket
DIN 71805

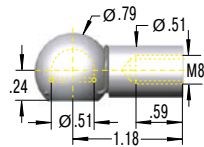

¹ max. force 270 lbs



NG8
Angle Bracket

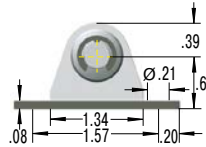

¹ max. force 225 lbs

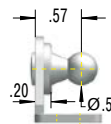

OG8
Side Bracket

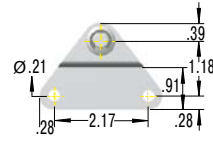

¹ max. force 270 lbs

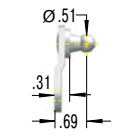

PG8
Round Bracket

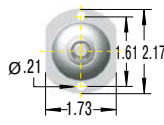

¹ max. force 270 lbs

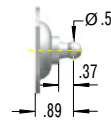

¹ Attention! Max. static load in Newtons. Beware force increase during compression (progression) and observe max. force limit.

M10x1.5 (for GS-28, GZ-28, HBD-50)

C10
Angle Ball Joint
DIN 71802

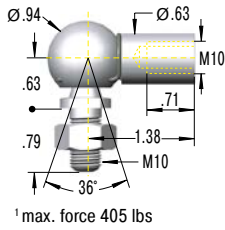

F10
Inline Ball Joint

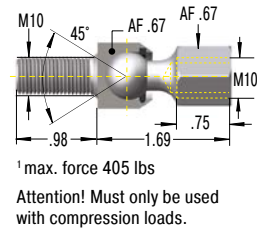

A10
Eye

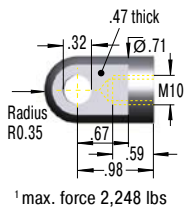

MA10
Bearing Shoe

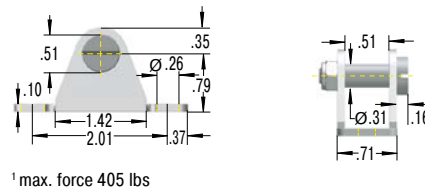

D10
Clevis Fork
DIN 71752

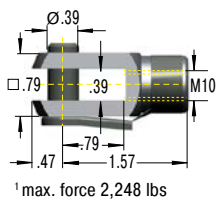

E10
Swivel Eye
DIN 648

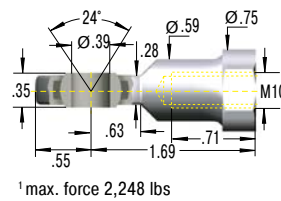

E10
Swivel Eye
DIN 648

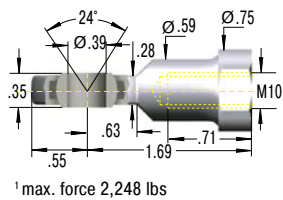

ME10
Bearing Shoe

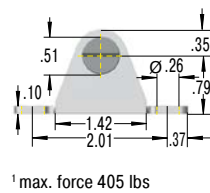

OE10
Side Bracket

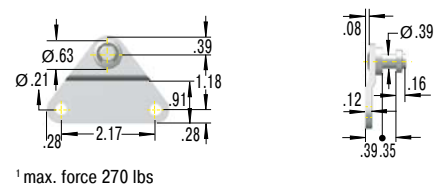

PE10
Round Bracket



Issue 04.2018 – Specifications subject to change

¹ Attention! Max. static load in Newtons. Beware force increase during compression (progression) and observe max. force limit.

M14x1.5 (for GS-40, GST-40, GZ-40, HBD-40, HB-40)

C14
Angle Ball Joint
DIN 71802

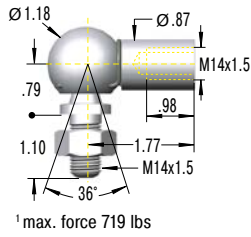

F14
Inline Ball Joint

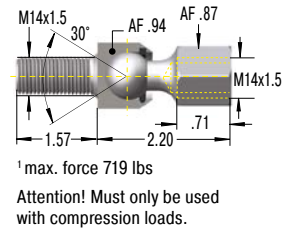

A14
Eye

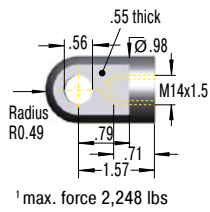

ME14
Bearing Shoe

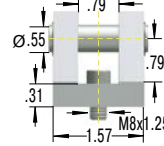
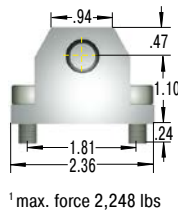

D14
Clevis Fork
DIN 71752

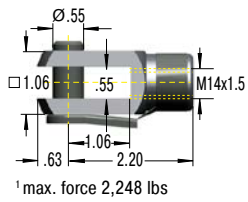

ND14
Mounting Flange

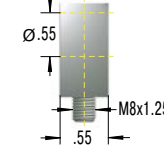
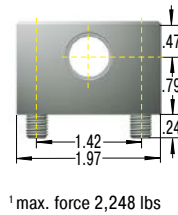

E14
Swivel Eye
DIN 648

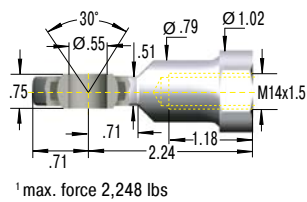

ME14
Bearing Shoe

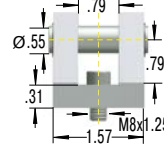
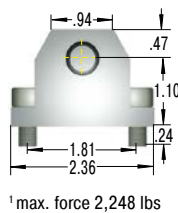

¹ Attention! Max. static load in Newtons. Beware force increase during compression (progression) and observe max. force limit.

M24x2 (for GS-70, HB-70)

D24
Clevis Fork
DIN 71752

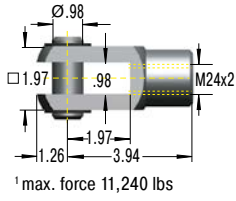

ND24
Mounting Flange

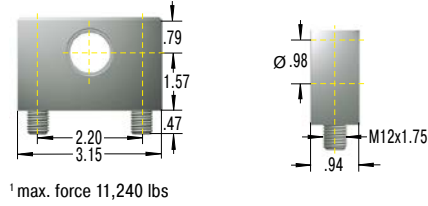

E24
Swivel Eye
DIN 648

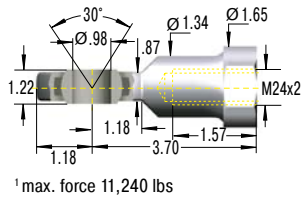

ME24
Bearing Shoe

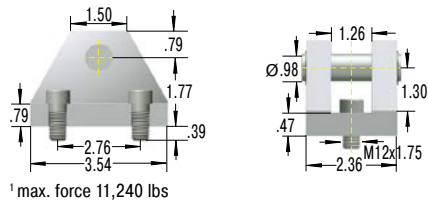

¹Attention! Max. static load in Newtons. Beware force increase during compression (progression) and observe max. force limit.

Mounting Accessories for stainless steel gas springs and hydraulic dampers

For our gas springs and hydraulic dampers made of stainless steel we also offer a flexible product range of DIN standardized end fittings and mounting brackets. These eyes, swivel eyes, clevis forks, angle ball joints, ball sockets, inline ball joints and mounting brackets are also made of sturdy stainless steel and can be easily combined.

The high-quality stainless steel accessories are rustproof and weakly magnetic. Just as with the corresponding stainless steel gas springs and hydraulic dampers, they are preferred in the food, electronics and ship building industries along with medical and cleanroom technology.

All ACE stainless steel gas springs and the appropriate mounting accessories are individually designed for each application with the ACE calculation program.

The entire range of stainless steel accessories is also available separately.

**Infinite
Combinations!**

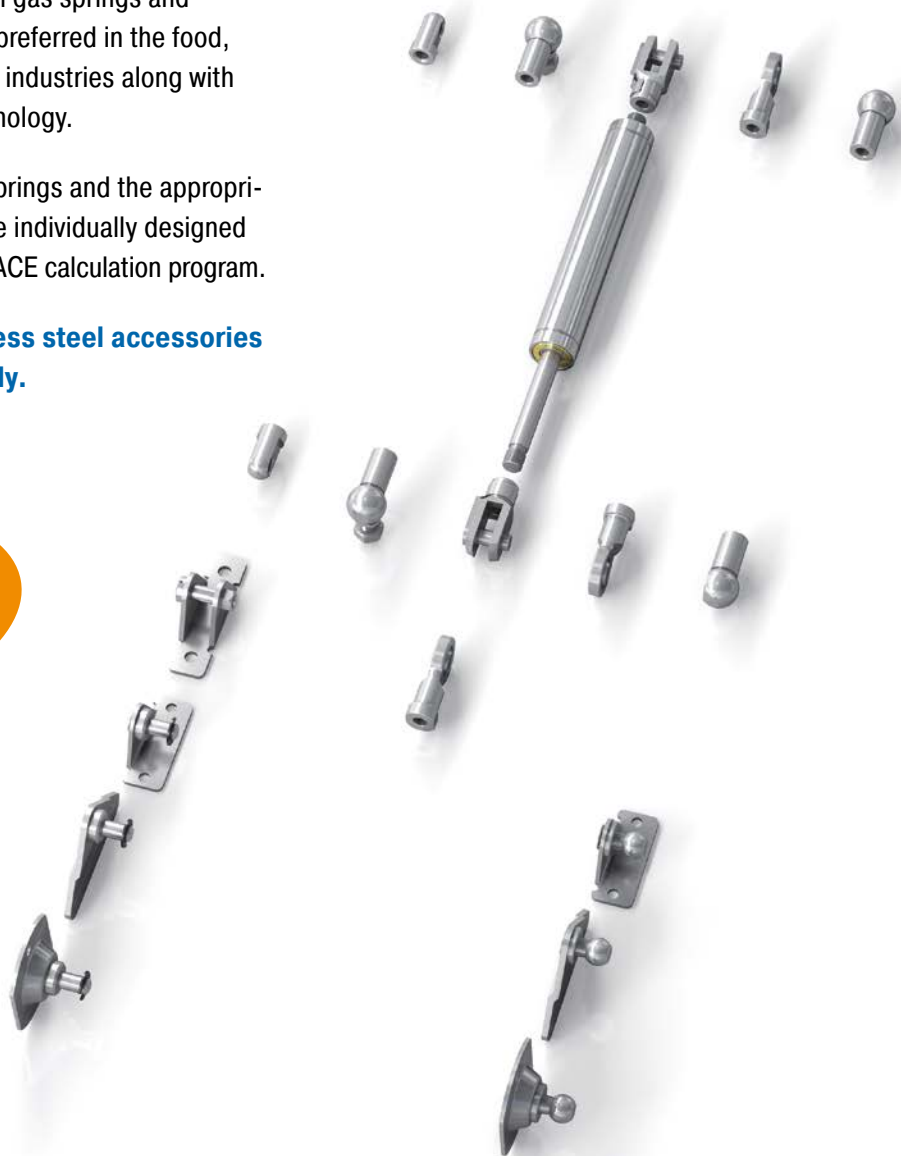

M3.5x0.6

(for GS-8-V4A, GS-10-V4A, GS-12-V4A, GZ-15-V4A)

C3.5-V4A Angle Ball Joint

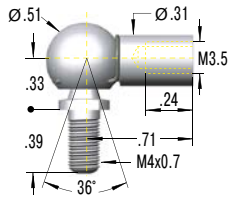

¹ max. force 83 lbs

A3.5-V4A Eye

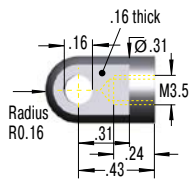

¹ max. force 83 lbs



NA3.5-V4A Angle Bracket

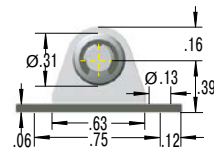

¹ max. force 40 lbs

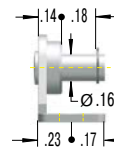

OA3.5-V4A Side Bracket

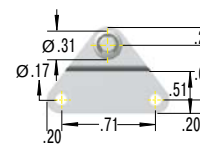

¹ max. force 40 lbs

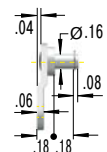

D3.5-V4A Clevis Fork

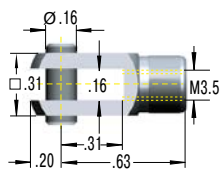

¹ max. force 83 lbs



A3.5-V4A Eye

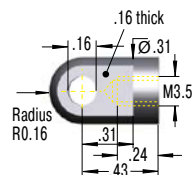

¹ max. force 83 lbs

G3.5-V4A Ball Socket

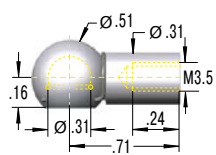

¹ max. force 83 lbs



NG3.5-V4A Angle Bracket

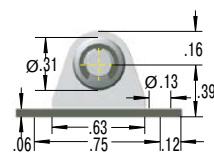

¹ max. force 40 lbs

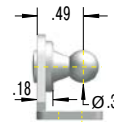

OG3.5-V4A Side Bracket

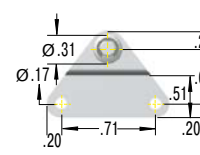

¹ max. force 40 lbs

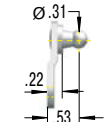

¹ Attention! Max. static load in Newtons. Beware force increase during compression (progression) and observe max. force limit.

M8x1.25 (for GS-19-VA, GS-22-VA, GZ-19-VA)

C8-VA
Angle Ball Joint

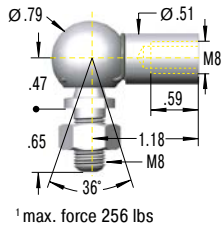

D8-VA
Clevis Fork

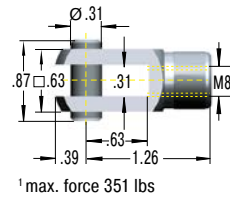

A8-VA
Eye

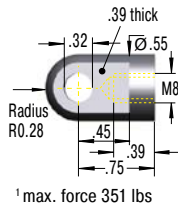

MA8-V4A
Bearing Shoe

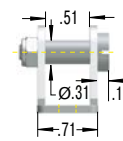
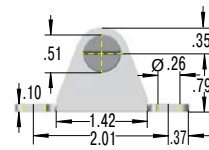

NA8-V4A
Angle Bracket

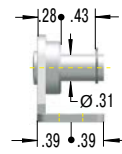
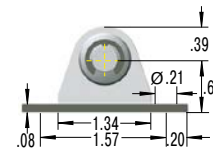

OA8-V4A
Side Bracket

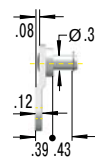
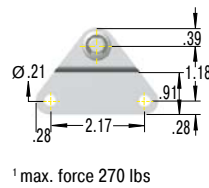

PA8-V4A
Round Bracket

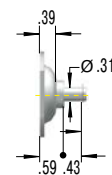
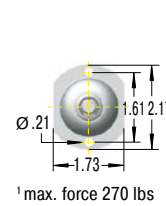

E8-VA
Swivel Eye

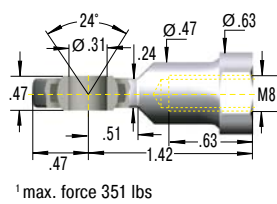

MA8-V4A
Bearing Shoe

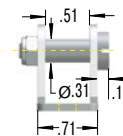
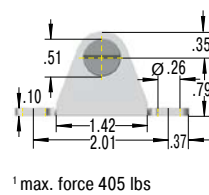

¹ Attention! Max. static load in Newtons. Beware force increase during compression (progression) and observe max. force limit.

M8x1.25 (for GS-19-VA, GS-22-VA, GZ-19-VA)

G8-VA
Ball Socket

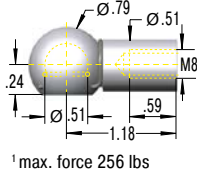

NG8-V4A
Angle Bracket

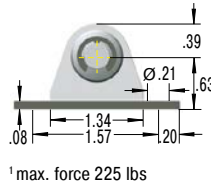

OG8-V4A
Side Bracket

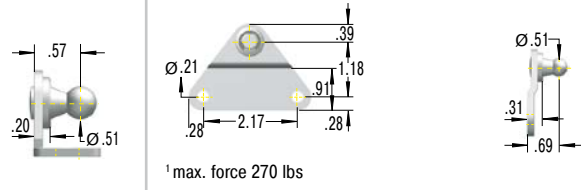

PG8-V4A
Round Bracket

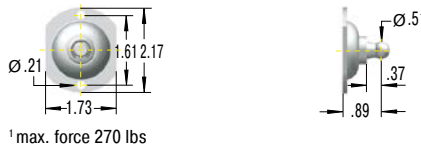

M10x1.5 (for GS-28-VA, GZ-28-VA)

C10-VA
Angle Ball Joint

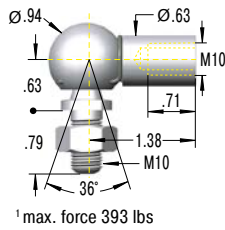

D10-VA
Clevis Fork

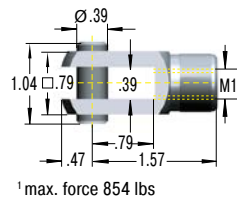

E10-VA
Swivel Eye

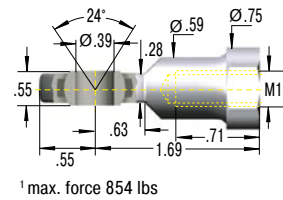

A10-VA
Eye

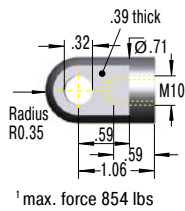

MA10-V4A
Bearing Shoe

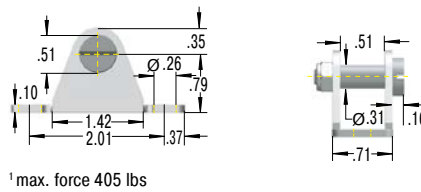

1 Attention! Max. static load in Newtons. Beware force increase during compression (progression) and observe max. force limit.

M14x1.5 (for GS-40-VA, GZ-40-VA)

C14-VA Angle Ball Joint

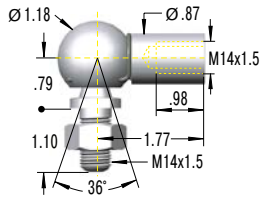

¹ max. force 719 lbs

A14-VA Eye

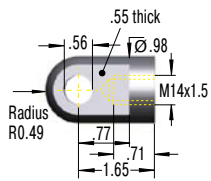

¹ max. force 1,574 lbs



ME14-VA Bearing Shoe

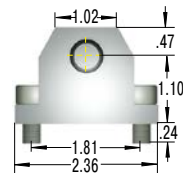

¹ max. force 2,248 lbs

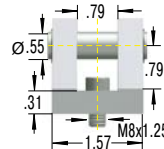

D14-VA Clevis Fork

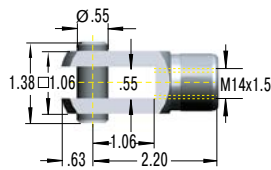

¹ max. force 1,574 lbs



ND14-VA Mounting Flange

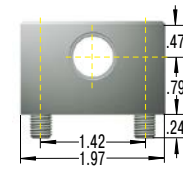

¹ max. force 2,248 lbs

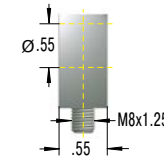

E14-VA Swivel Eye

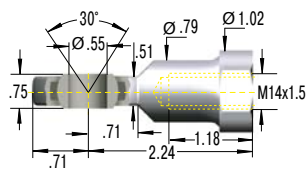

¹ max. force 1,574 lbs



ME14-VA Bearing Shoe

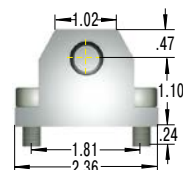

¹ max. force 2,248 lbs

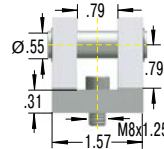

¹ Attention! Max. static load in Newtons. Beware force increase during compression (progression) and observe max. force limit.

Hydraulic Feed Controls

Regulate feed rates in the best way

ACE Hydraulic feed controls are recommended as the perfect solution when sawing, cutting, drilling and in order to prevent the stick-slip effect on pneumatic cylinders. They can be precisely adjusted and provide speeds from 1/2"/min. (12 mm/min.) with a very low feed force or up to 1.5"/min. (38 m/min.) with a high feed rate

These maintenance-free, ready-to-install hydraulic feed controls are self-contained hydraulic elements regulated by a precision throttle. The feed rate is set from the outside by turning the setting adjuster. The tried-and-tested rolling diaphragms used in many ACE shock absorbers also serve as a dynamic sealing element for a hermetic seal as well as volume compensation for the piston rod and provide the resetting of the piston when the force is removed.



Hydraulic Feed Controls



VC25

Adjustable

For precision adjustment of feed rates

Handling modules, Linear slides, Automatic machinery,
Conveyor equipment

Page 228



MA, MVC

Adjustable

Designed for applications with low precision requirements

Handling modules, Linear slides, Automatic machinery,
Conveyor equipment

Page 230

Shorter processing times

Different feed rates

Adjustment segment at the lower end of the feed control

Most accurate calibrations

Available immediately

Easy to mount



VC25

For precision adjustment of feed rates

Adjustable

Compression force 6.74 lbs to 787 lbs

Stroke 0.59 in to 4.92 in

Precise adjustment for any type of application: Hydraulic feed controls of the product family VC are ideally suited for the precise tuning of constant feed rates. The thread of the outer body of this closed hydraulic element allows simple assembly. Smooth outer bodies can also be supplied.

As the hydraulic oil is forced out through the throttle opening, a constant feed rate is achieved on the stroke. In the models up to 2.17" (55 mm) stroke, the tried and tested rolling diaphragm, known from ACE shock absorbers, serves as a dynamic seal, as volume compensation of the piston rod and as a reset element.

Precision hydraulic feed controls of the product family VC are used in automotive and industrial applications as well as in mechanical engineering and the electronics industry.

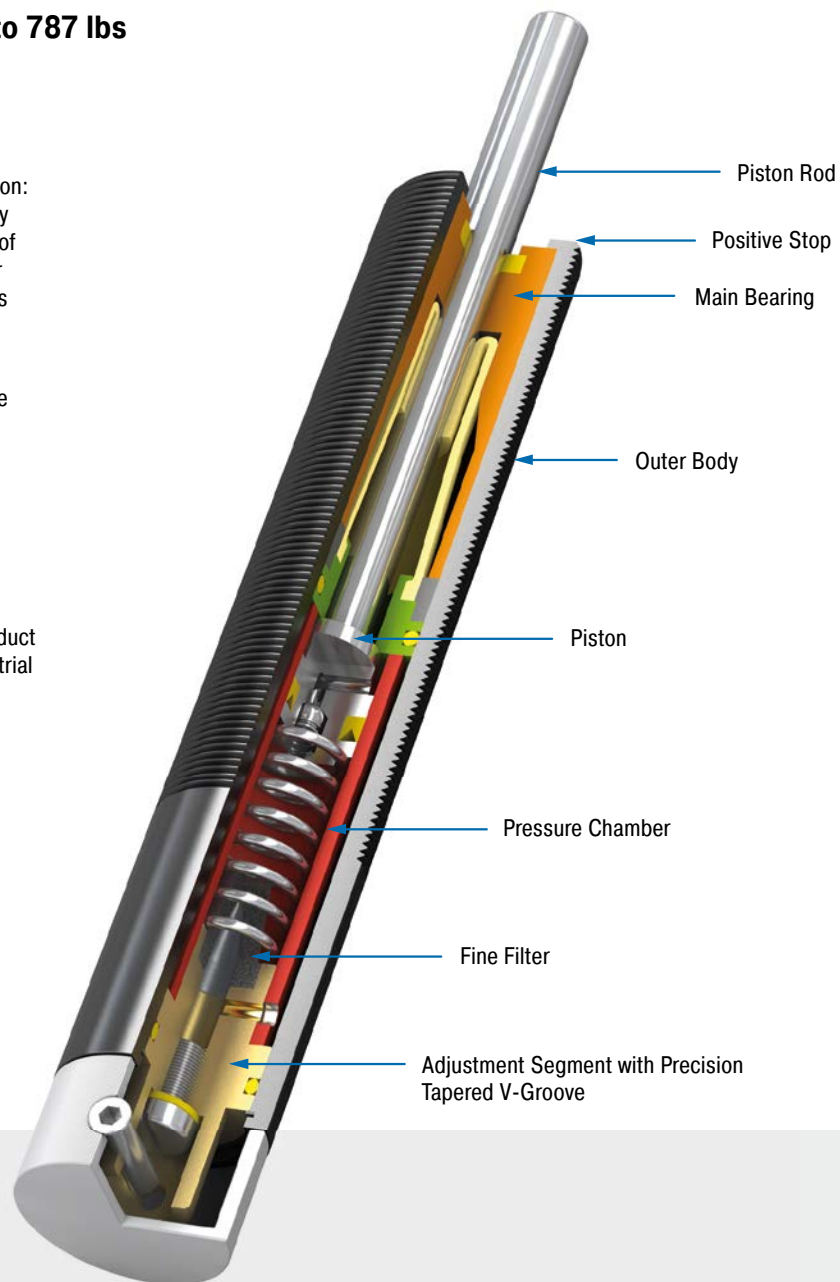

Technical Data

Compression force: 6.74 lbs to 787 lbs

Execution: F = Ø 0.94 in without thread
FT = M25x1.5 threaded body

Piston rod diameter: Ø 0.31 in

Feed rate/Compression force:

Min. 0.51 in/min. with 90 lbs;
Max. 1,500 in/min. with 787 lbs

Impact velocity range: At speeds of 0.98 ft/sec the maximum allowed energy is approx. 8.85 in-lbs for units up to 2.16 in stroke and approx. 17.70 in-lbs for units 2.95 in to 4.92 in stroke. Where higher energies occur use a shock absorber for the initial impact. Avoid high impact velocities.

Adjustment: Infinitely adjustable

Positive stop: External positive stops 0.04 in to 0.06 in before the end of stroke provided by the customer.

Damping medium: Oil, temperature stable

Material: Outer body: Black anodized aluminium ; Piston rod: Hard chrome plated steel ; Accessories: Steel with black oxide finish or nitride hardened

Mounting: In any position

Operating temperature range: 32 °F to 140 °F

Application field: Handling modules, Linear slides, Automatic machinery, Conveyor equipment, Absorption control

Note: Nylon button can be fitted onto piston rod. Unit may be mounted in any position.

Safety information: Do not rotate piston rod, if excessive rotation force is applied rolling seal may rupture. External materials in the surrounding area can attack the seal components and lead to a shorter service life. Please contact ACE for appropriate solution suggestions.

On request: Special oil and other special options available on request.

Adjustable

VC25FT

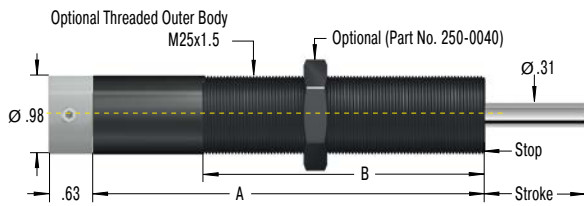

SP25 Air Bleed Collar

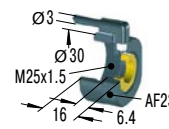

For VC2515FT to VC2555FT
reduction of the stroke 0.25 inch

250-0044 Mounting Block

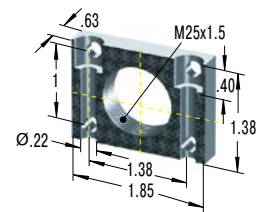

VC25F

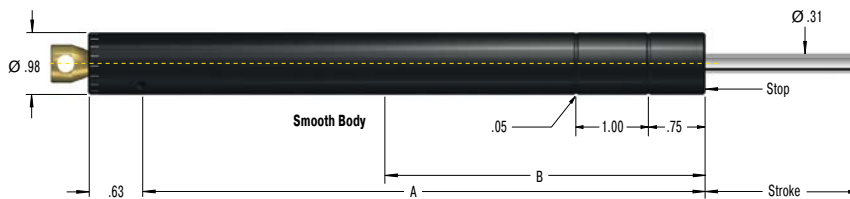

SP25 Air Bleed Collar

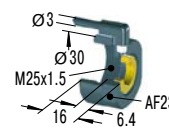

For VC2515FT to VC2555FT
reduction of the stroke 0.25 inch

250-0044 Mounting Block

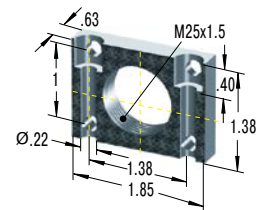

Additional accessories, mounting, installation ... see from page 47.

Complete details required when ordering

- Load to be decelerated: W (lbs)
- Impact velocity: v (ft/s)
- Propelling force: F (lbs)
- Operating cycles per hour: c (/hr)
- Number of absorbers in parallel: n
- Ambient temperature: °F

Ordering Example

Type (Feed Control) _____ **VC2555FT**
 25 for Thread Size M25 _____
 Stroke 2.16" (55 mm) _____
 FT = with thread M25x1.5 _____
 F = without thread, plain body (Ø 0.94" / 23.8 mm)

Performance and Dimensions

| TYPES | Stroke inch | A inch | B inch | Compression force min. lbs | Compression force max. lbs | Return Force min. lbs | Return Force max. lbs | Return Time s | Side Load Angle max. ° | Weight lbs |
|-----------|----------------|-----------|-----------|----------------------------------|----------------------------------|-----------------------------|-----------------------------|------------------|------------------------------|---------------|
| VC2515FT | 0.59 | 5.04 | 3.15 | 6.74 | 787 | 3.37 | 6.74 | 0.2 | 3 | 0.529 |
| VC2530FT | 1.18 | 6.34 | 4.33 | 6.74 | 787 | 1.12 | 6.74 | 0.4 | 2 | 0.617 |
| VC2555FT | 2.16 | 8.23 | 5.19 | 7.87 | 787 | 1.12 | 8.99 | 1.2 | 2 | 0.926 |
| VC2575FT | 2.95 | 11.14 | 5.90 | 11.24 | 787 | 2.25 | 11.24 | 1.7 | 2 | 1.058 |
| VC25100FT | 3.94 | 12.13 | 5.90 | 13.49 | 787 | 2.25 | 11.24 | 2.3 | 1 | 1.103 |
| VC25125FT | 4.92 | 13.13 | 5.90 | 15.74 | 787 | 2.25 | 13.49 | 2.8 | 1 | 1.191 |
| VC2515F | 0.59 | 5.04 | 3.15 | 6.74 | 787 | 3.37 | 6.74 | 0.2 | 3 | 0.529 |
| VC2530F | 1.18 | 6.34 | 4.33 | 6.74 | 787 | 1.12 | 6.74 | 0.4 | 2 | 0.617 |
| VC2555F | 2.16 | 8.23 | 5.19 | 7.87 | 787 | 1.12 | 8.99 | 1.2 | 2 | 0.926 |
| VC2575F | 2.95 | 11.14 | 5.90 | 11.24 | 787 | 2.25 | 11.24 | 1.7 | 2 | 1.058 |
| VC25100F | 3.94 | 12.13 | 5.90 | 13.49 | 787 | 2.25 | 11.24 | 2.3 | 1 | 1.103 |
| VC25125F | 4.92 | 13.13 | 5.90 | 15.74 | 787 | 2.25 | 13.49 | 2.8 | 1 | 1.191 |

Suffix FT: M25x1.5 threaded body.

Suffix F: plain body 23.8 mm dia. (without thread), with optional clamp type mounting block.

Operating range VC

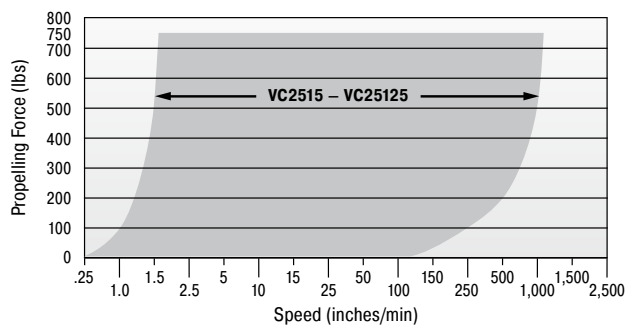

Accessories with Mounting Example



Mounting with clamp mount



Installed with air bleed collar SP25 (part no. 10783-000)

Products for
UNF and metric thread
available

MA, MVC

Designed for applications with low precision requirements

Adjustable

Compression force 2 lbs to 800 lbs

Stroke 0.28 in to 1.58 in

Many application options: the hydraulic feed controls in models MA and MVC are similar to that of the VC model. However, these hydraulic controls have been designed for applications that require less precision.

There are also plenty of accessories for the MA and MVC models. All products are ready-to-install, maintenance-free, stable in temperature and avoid stick-slip effect. Speeds from 0.47"/min. (12 mm/min.) can be driven at a low thrust force using the adjustment screw on the base of the hydraulic control.

Hydraulic feed controls with the designations MA and MVC are especially used in handling modules or linear carriages and also for applications with changing usage data.

Operating Range MVC225 to MVC900

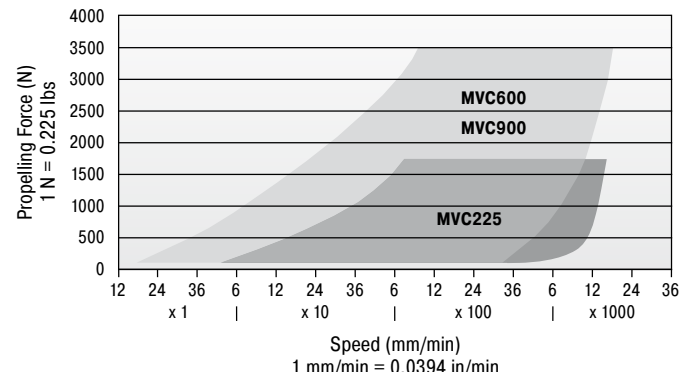

Performance and Dimensions

| TYPES | Stroke inch | Compression force min. lbs | Compression force max. lbs | Return Force min. lbs | Return Force max. lbs | Return Time s | ¹ Side Load Angle max. ° | M | Weight lbs |
|--------|----------------|----------------------------------|----------------------------------|-----------------------------|-----------------------------|------------------|---|-----------------------|---------------|
| MA30M | 0.32 | 2 | 18 | 1.16 | 1.57 | 0.3 | 2 | M8x1 | 0.029 |
| MA50M | 0.28 | 9 | 36 | 0.47 | 1.80 | 0.3 | 2 | M10x1 | 0.055 |
| MA35 | 0.40 | 3.3 | 45 | 1.20 | 2.60 | 0.2 | 2 | 1/2-20 UNF / M12x1 | 0.095 |
| MA150 | 0.50 | 4.5 | 67.4 | 0.70 | 1.20 | 0.4 | 2 | 9/16-18 UNF / M14x1.5 | 0.135 |
| MVC225 | 0.75 | 5 | 400 | 1.05 | 2.15 | 0.65 | 2 | 3/4-16 UNF / M20x1.5 | 0.381 |
| MVC600 | 1.00 | 14 | 800 | 2.40 | 6.87 | 0.85 | 2 | 1-12 UNF / M25x1.5 | 0.776 |
| MVC900 | 1.58 | 15 | 800 | 2.40 | 7.40 | 0.95 | 2 | 1-12 UNF / M25x1.5 | 0.913 |

¹ For applications with higher side load angles consider using the side load adaptor, pages 44 to 49.

Technical Data

Compression force: 2 lbs to 800 lbs

Execution: Thread M8 to M25

Impact velocity range: At speeds of 0.98 ft/sec the maximum allowed energy is approx. 17.70 in-lbs. Where higher energies occur use a shock absorber for the initial impact. Avoid high impact velocities.

Adjustment: Hard impact at the start of stroke, turn towards 9 or PLUS. Hard impact at the end of stroke, turn towards 0 or MINUS.

Positive stop: Integrated

Damping medium: Oil, temperature stable

Material: Outer body: Nitride hardened steel; Piston rod: Steel with black oxide finish or nitride hardened

Mounting: In any position

Operating temperature range: 32 °F to 150 °F

Application field: Handling modules, Linear slides, Automatic machinery, Conveyor equipment, Absorption control

Note: Damper is preset at delivery in a neutral position between hard and soft.

Safety information: External materials in the surrounding area can attack the seal components and lead to a shorter service life. Please contact ACE for appropriate solution suggestions.

On request: Nickel-plated, weartec finish (seawater resistant) or other special options available on request.

Products for UNF and metric thread available

Adjustable

MA30M

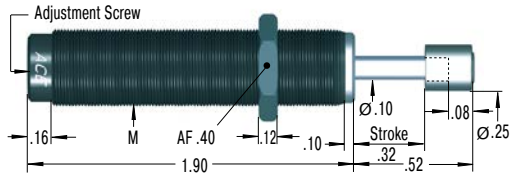

MA50M

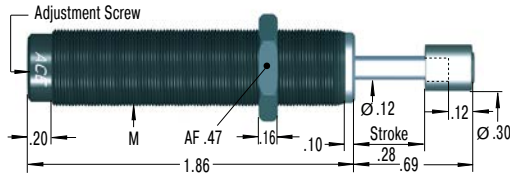

MA35

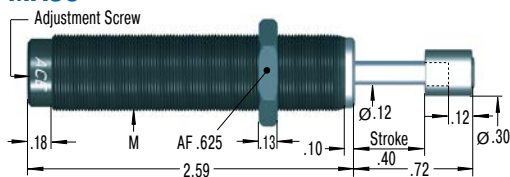

Product available for UNF and metric thread (for metric add suffix -M from part number)

MA150

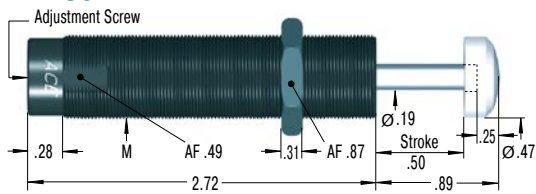

Product available for UNF and metric thread (for metric add suffix -M from part number)

MVC225

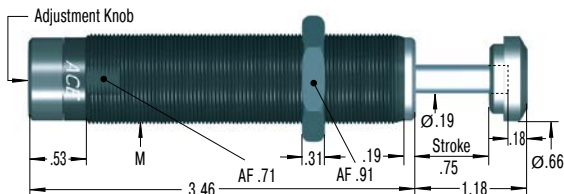

Product available for UNF and metric thread (for metric add suffix -M from part number)

MVC600

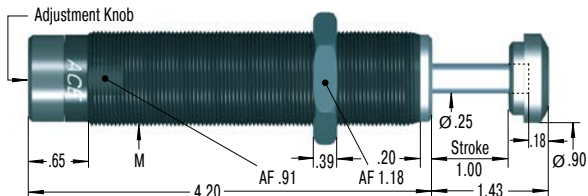

Product available for UNF and metric thread (for metric add suffix -M from part number)

MVC900

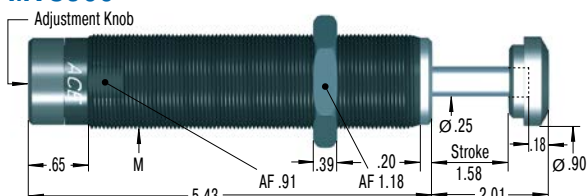

Product available for UNF and metric thread (for metric add suffix -M from part number)

250-0307

Mounting Block

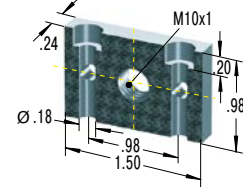

250-0308

Mounting Block

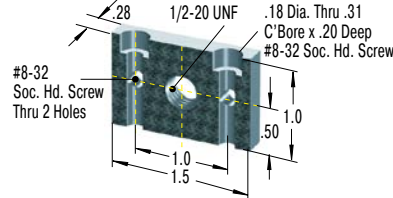

250-0309

Mounting Block

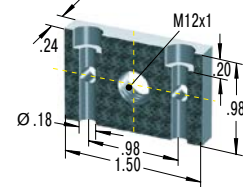

250-0318

Mounting Block

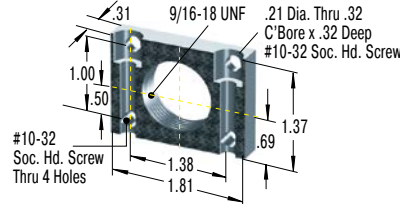

250-0352

Mounting Block

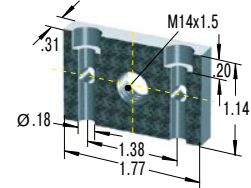

250-0401

Mounting Block

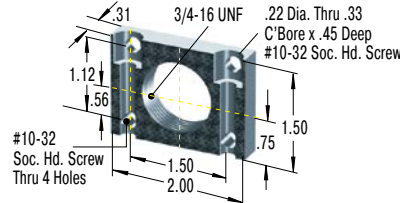

250-0353

Mounting Block

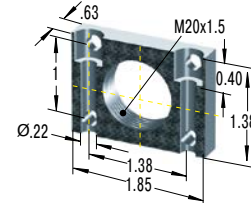

250-0402

Mounting Block

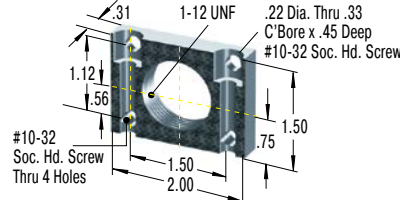

250-0044

Mounting Block

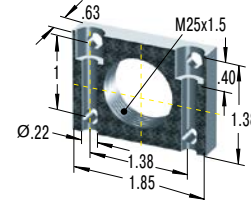

250-0402

Mounting Block

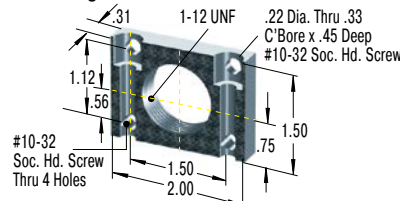

250-0044

Mounting Block

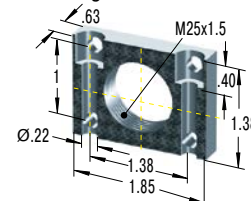

Additional accessories, mounting, installation ... see from page 44.

Rotary Dampers

Small dampers refine your design

ACE rotary dampers provide an invisible yet valuable service as a maintenance-free machine element to allow controlled deceleration of rotary or linear movements.

They are often necessary to make careful opening and closing of small lids, compartments and drawers possible. They protect sensitive components while increasing the quality and value of products. They are easy to integrate. The harmoniously gentle movements of these little decelerators can be achieved with continual rotation or with limited pivoting angles. They slow down left, right or bi-directional rotation. Suitable for almost any application and also available in adjustable variations, they provide braking torques of 0.44 in-lbs to 354 in-lbs.

Partial Rotation Angle, Adjustable

e.g. FYT-H1 and FYN-H1

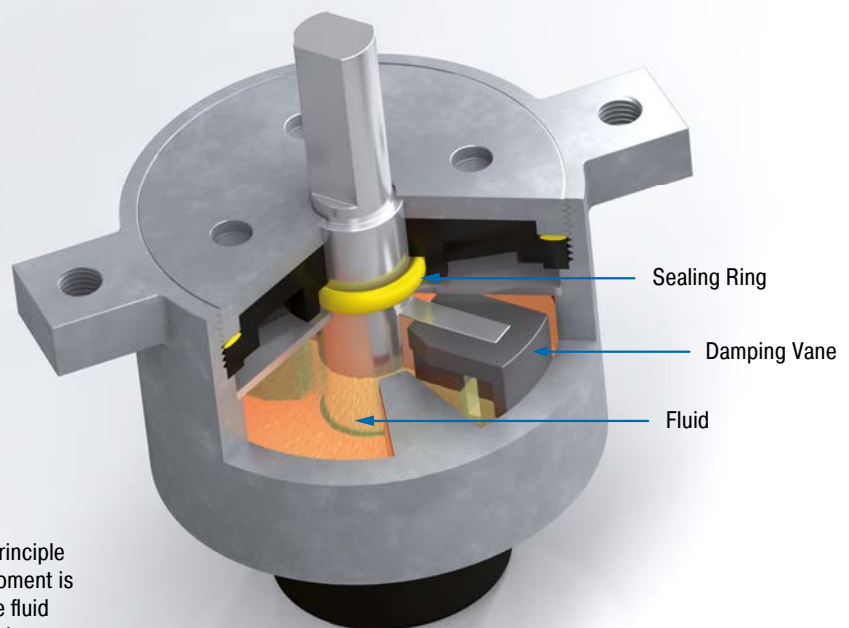

General Function

Rotary dampers operate on the principle of fluid damping. The damping moment is determined by the viscosity of the fluid and the dimensioning of the throttle gap or throttle orifices.



Rotary Dampers with Continuous Rotation

Rotate for the plus in quality: For smooth, quiet movements of small hoods, flaps and fans these continuously rotating rotary dampers from ACE decelerate either right, left or two-sided rotation right in the pivot point or linear through a gear and gear rack. The harmoniously gentle process protects components and increases the quality and value of products. The maintenance-free, ready-to-install ACE rotary dampers are filled with an inert fluid, usually silicone oil. The viscosity of the fluid and the sizing of the throttling gap determine the damping torque. The FFD series is the only exception: These fluid-free rotary dampers operate according to the principle of friction.

The continuously rotating rotary dampers with the designations FRT, FRN, FFD, FDT and FDN are used in household and medical devices as well as in the automotive, electronics and furniture industries.



Rotary Dampers with Partial Rotation Angle

For controlled and gentle deceleration: The damping direction of this rotary damper, which is available with adjustable damping torque, can be right, left or two-sided rotation. They can be installed directly in the pivot point of a construction and achieve uniform, quiet movements, which increases quality and value and protects sensitive components. The products are maintenance-free, ready-to-install and filled with an inert fluid, usually silicone oil. A rotor movement presses the fluid from one chamber into the other. The damping torque is determined by the viscosity of the fluid and the sizing of the throttling gap the throttle holes. During each reversal of movement, depending on the frame size a certain return damping torque develops.

These solutions are used in the automotive sector, in many industrial applications, in the electronics and furniture industries as well as in medical devices.

High protection of sensitive components

Various designs for every application

Maintenance-free and ready-to-install

Partial Rotation Angle

e.g. FYN-N1

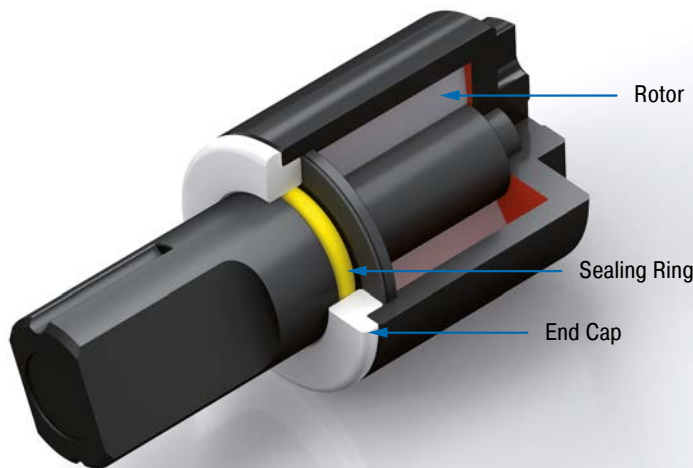

Continuous Rotation

e.g. FRT-E2

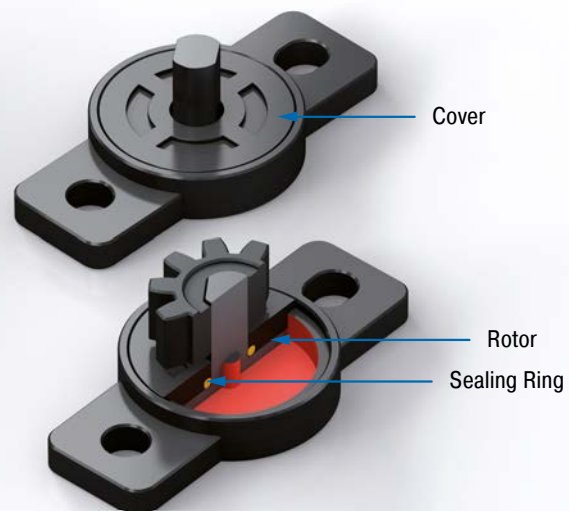

Rotary Dampers



Continuous rotation



FRT-E2

Page 236

Continuous Rotation
Small and lightweight for finest braking



FRT-G2

Page 237

Continuous Rotation
Small and lightweight for finest braking



FRT-C2 and FRN-C2

Page 238

Continuous Rotation
Flexible and cost efficient use



FRT-D2 and FRN-D2

Page 239

Continuous Rotation
Flexible and cost efficient use



FRT-F2/K2 and FRN-F2/K2

Page 240

Continuous Rotation
For a long service life



FFD

Page 241

Continuous Rotation
Precise braking without oil



FDT

Page 242

Continuous Rotation
The flat disc brake for two-sided damping



FDN

Page 243

Continuous Rotation
The flat disc brake for one direction of rotation

Rotary Dampers



FYN-P1

Page 244

Partial Rotation Angle
Small diameter, large damping torques



FYN-N1

Page 245

Partial Rotation Angle
Small diameter, large damping torques



FYN-U1

Page 246

Partial Rotation Angle
Small, strong and very robust



FYN-S1

Page 247

Partial Rotation Angle
The flat damper for constant component protection



FYT-H1 and FYN-H1

Page 248

Partial Rotation Angle, Adjustable
Specifically adjustable, strong braking force



FYT-LA3 and FYN-LA3

Page 249

Partial Rotation Angle, Adjustable
Adjustable high performance

FRT-E2

Small and lightweight for finest braking

Continuous Rotation

Damping torque **0.009 in-lbs to 0.035 in-lbs**

The damping direction of the smallest ACE FRT-E2 rotary dampers with plastic body is rotating on both sides. They can brake directly in the pivot point or linear through a gear and gear rack. ACE rotary dampers are maintenance-free and ready-to-install.

Rotary damper products are built to metric specifications. For precise measurements, please refer to the ACE rotary damper catalog or contact an application expert.



Technical Data

Construction size: \varnothing 0.39 in

Rotational speed max.: 50 rpm

Lifetime: 50,000 cycles (1 cycle = 360° left-hand, 360° right-hand). Even after this time, the dampers still produce over approx. 80 % of their original damping moment. The service life may be significantly higher or lower, depending on the application.

Operating temperature range: 32 °F to 122 °F

Pressure angle: 20°

Material: Outer body, Shaft, Gear: Plastic

Mounting: In any position

Tooth: Involute gearing

P.C.D.: 0.24 in

No. of teeth: 10

Module: 0.6

Mounting information: No axial or radial forces may be induced via the shaft.

Safety information: Do not use rotary dampers as supports. Provide an external guide or support.

On request: Special designs available on request. Toothed plastic racks (modules 0.5 to 1.0) are available for the rotary dampers with pinions.

Characteristics

At 73 °F ambient temperature

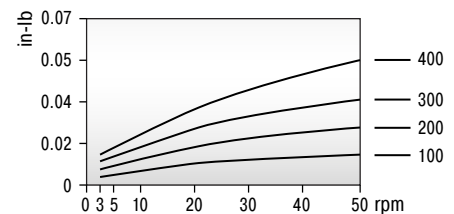

At 20 rpm rotational speed

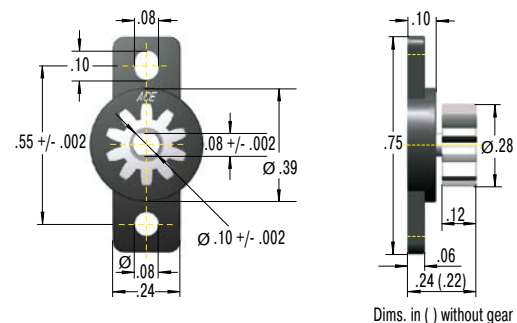
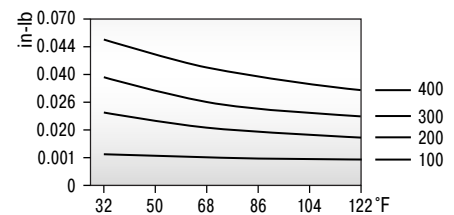

Dims. in () without gear

Performance

| TYPES | ¹ Damping torque in-lbs | Damping direction | Gear | Weight lbs |
|---------------|---------------------------------------|-------------------|---------|---------------|
| FRT-E2-100 | 0.009 +/- 0.004 | bidirectional | without | 0.00071 |
| FRT-E2-200 | 0.018 +/- 0.006 | bidirectional | without | 0.00071 |
| FRT-E2-300 | 0.026 +/- 0.007 | bidirectional | without | 0.00071 |
| FRT-E2-400 | 0.035 +/- 0.009 | bidirectional | without | 0.00071 |
| FRT-E2-100-G1 | 0.009 +/- 0.004 | bidirectional | with | 0.00090 |
| FRT-E2-200-G1 | 0.018 +/- 0.006 | bidirectional | with | 0.00090 |
| FRT-E2-300-G1 | 0.026 +/- 0.007 | bidirectional | with | 0.00090 |
| FRT-E2-400-G1 | 0.035 +/- 0.009 | bidirectional | with | 0.00090 |

¹ The indicated damping torque refers to a rotational speed of 20 rpm and an ambient temperature of 73 °F.

FRT-G2

Small and lightweight for finest braking

Continuous Rotation

Damping torque 0.018 in-lbs to 0.088 in-lbs

The damping direction of the ACE FRT-G2 product family with plastic body is rotating on both sides. The small rotary dampers can brake directly in the pivot point or linear through a gear and gear rack. ACE rotary dampers are maintenance-free and ready-to-install.

Rotary damper products are built to metric specifications. For precise measurements, please refer to the ACE rotary damper catalog or contact an application expert.



Technical Data

Construction size: Ø 0.59 in

Rotational speed max.: 50 rpm

Lifetime: 50,000 cycles (1 cycle = 360° left-hand, 360° right-hand). Even after this time, the dampers still produce over approx. 80 % of their original damping moment. The service life may be significantly higher or lower, depending on the application.

Operating temperature range: 32 °F to 122 °F

Pressure angle: 20°

Material: Outer body, Shaft, Gear: Plastic

Mounting: In any position

Tooth: Involute gearing

P.C.D.: 0.28 in

No. of teeth: 14

Module: 0.5

Mounting information: No axial or radial forces may be induced via the shaft.

Safety information: Do not use rotary dampers as supports. Provide an external guide or support.

On request: Special designs available on request. Toothed plastic racks (modules 0.5 to 1.0) are available for the rotary dampers with pinions.

Characteristics

At 73 °F ambient temperature

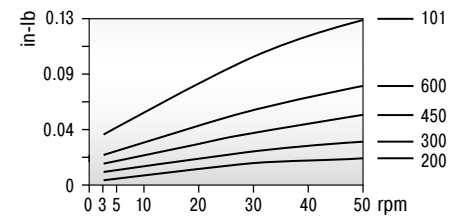

At 20 rpm rotational speed

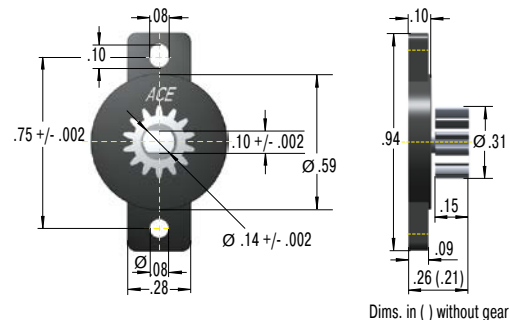
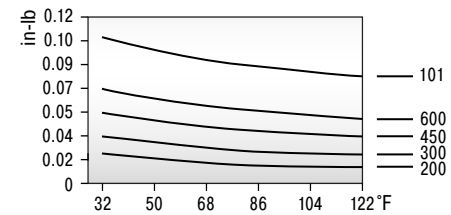

Dims. in () without gear

Performance

| TYPES | ¹ Damping torque in-lbs | Damping direction | Gear | Weight lbs |
|---------------|---------------------------------------|-------------------|---------|---------------|
| FRT-G2-200 | 0.018 +/- 0.006 | bidirectional | without | 0.00132 |
| FRT-G2-300 | 0.026 +/- 0.007 | bidirectional | without | 0.00132 |
| FRT-G2-450 | 0.041 +/- 0.009 | bidirectional | without | 0.00132 |
| FRT-G2-600 | 0.053 +/- 0.011 | bidirectional | without | 0.00132 |
| FRT-G2-101 | 0.088 +/- 0.018 | bidirectional | without | 0.00132 |
| FRT-G2-200-G1 | 0.018 +/- 0.006 | bidirectional | with | 0.00176 |
| FRT-G2-300-G1 | 0.027 +/- 0.007 | bidirectional | with | 0.00176 |
| FRT-G2-450-G1 | 0.041 +/- 0.009 | bidirectional | with | 0.00176 |
| FRT-G2-600-G1 | 0.053 +/- 0.011 | bidirectional | with | 0.00176 |
| FRT-G2-101-G1 | 0.088 +/- 0.018 | bidirectional | with | 0.00176 |

¹ The indicated damping torque refers to a rotational speed of 20 rpm and an ambient temperature of 73 °F.

FRT-C2 and FRN-C2

Flexible and cost efficient use

Continuous Rotation

Damping torque 0.18 in-lbs to 0.27 in-lbs

The damping direction of the simple FRT-C2 and FRN-C2 is either right, left or two-sided rotation. These ACE rotary dampers with plastic body can decelerate directly in the pivot point or linear through a gear and gear rack. ACE rotary dampers are maintenance-free and ready-to-install.

Rotary damper products are built to metric specifications. For precise measurements, please refer to the ACE rotary damper catalog or contact an application expert.



Technical Data

Construction size: \varnothing 0.59 in

Rotational speed max.: 50 rpm

Lifetime: 50,000 cycles (1 cycle = 360° left-hand, 360° right-hand). Even after this time, the dampers still produce over approx. 80 % of their original damping moment. The service life may be significantly higher or lower, depending on the application.

Operating temperature range: 32 °F to 122 °F

Pressure angle: 20°

Material: Outer body, Gear: Plastic ; Shaft: Plastic, steel

Mounting: In any position

Tooth: Involute gearing

P.C.D.: 0.35 in

No. of teeth: 11

Module: 0.8

Mounting information: No axial or radial forces may be induced via the shaft.

Safety information: Do not use rotary dampers as supports. Provide an external guide or support.

On request: Special designs available on request. Toothed plastic racks (modules 0.5 to 1.0) are available for the rotary dampers with pinions.

Characteristics

At 73 °F ambient temperature

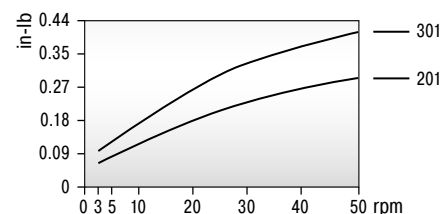

At 20 rpm rotational speed

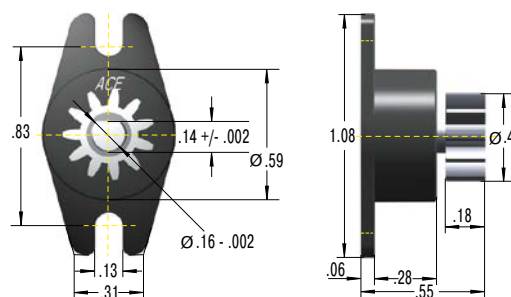
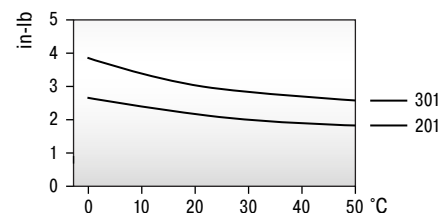

Performance

| TYPES | ¹ Damping torque in-lbs | Damping direction | Gear | Weight lbs |
|----------------|---------------------------------------|-------------------|---------|---------------|
| FRT-C2-201 | 0.18 +/- 0.05 | bidirectional | without | 0.005 |
| FRT-C2-301 | 0.27 +/- 0.07 | bidirectional | without | 0.005 |
| FRT-C2-201-G1 | 0.18 +/- 0.05 | bidirectional | with | 0.005 |
| FRT-C2-301-G1 | 0.27 +/- 0.07 | bidirectional | with | 0.005 |
| FRN-C2-R201 | 0.18 +/- 0.05 | right | without | 0.004 |
| FRN-C2-R301 | 0.27 +/- 0.07 | right | without | 0.004 |
| FRN-C2-R201-G1 | 0.18 +/- 0.05 | right | with | 0.004 |
| FRN-C2-R301-G1 | 0.27 +/- 0.07 | right | with | 0.004 |
| FRN-C2-L201 | 0.18 +/- 0.05 | left | without | 0.004 |
| FRN-C2-L301 | 0.27 +/- 0.07 | left | without | 0.004 |
| FRN-C2-L201-G1 | 0.18 +/- 0.05 | left | with | 0.004 |
| FRN-C2-L301-G1 | 0.27 +/- 0.07 | left | with | 0.004 |

¹ The indicated damping torque refers to a rotational speed of 20 rpm and an ambient temperature of 73 °F.

FRT-D2 and FRN-D2

Flexible and cost efficient use

Continuous Rotation

Damping torque 0.44 in-lbs to 2.21 in-lbs

The damping direction of the ACE FRT-D2 and FRN-D2 rotary dampers with plastic body is either the right, left or two-sided rotation. They can decelerate directly in the pivot point or linear through a gear and gear rack. ACE rotary dampers are maintenance-free and ready-to-install.

Rotary damper products are built to metric specifications. For precise measurements, please refer to the ACE rotary damper catalog or contact an application expert.



Technical Data

Construction size: Ø 1 in

Rotational speed max.: 50 rpm

Lifetime: 50,000 cycles (1 cycle = 360° left-hand, 360° right-hand). Even after this time, the dampers still produce over approx. 80 % of their original damping moment. The service life may be significantly higher or lower, depending on the application.

Operating temperature range: 32 °F to 122 °F

Pressure angle: 20°

Material: Outer body, Gear: Plastic ; Shaft: Plastic, steel

Mounting: In any position

Tooth: Involute gearing (addendum modification coefficient: +0.375)

P.C.D.: 0.47 in

No. of teeth: 12

Module: 1

Mounting information: No axial or radial forces may be induced via the shaft.

Safety information: Do not use rotary dampers as supports. Provide an external guide or support.

On request: Special designs available on request. Toothed plastic racks (modules 0.5 to 1.0) are available for the rotary dampers with pinions.

Characteristics

At 73 °F ambient temperature

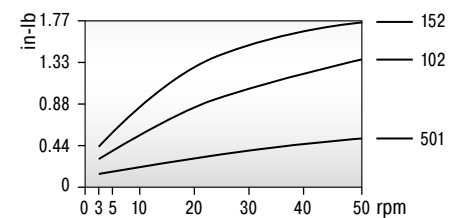

At 20 rpm rotational speed

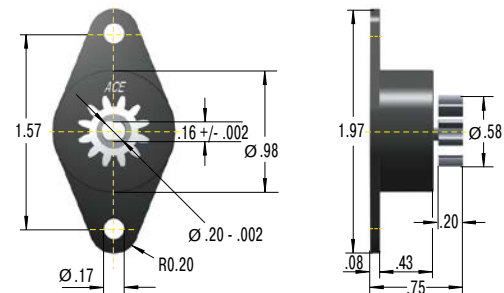
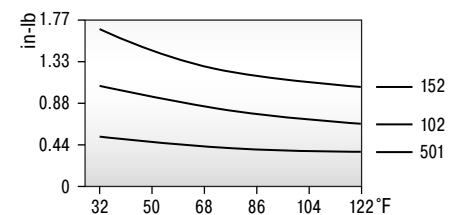

Performance

| TYPES | ¹ Damping torque in-lbs | Damping direction | Gear | Weight lbs |
|----------------|---------------------------------------|-------------------|---------|---------------|
| FRT-D2-102 | 0.88 +/- 0.18 | bidirectional | without | 0.018 |
| FRT-D2-152 | 1.33 +/- 0.26 | bidirectional | without | 0.018 |
| FRT-D2-501 | 0.44 +/- 0.09 | bidirectional | without | 0.018 |
| FRT-D2-102-G1 | 0.88 +/- 0.18 | bidirectional | with | 0.019 |
| FRT-D2-152-G1 | 1.33 +/- 0.26 | bidirectional | with | 0.019 |
| FRT-D2-501-G1 | 0.44 +/- 0.09 | bidirectional | with | 0.019 |
| FRN-D2-R102 | 0.88 +/- 0.18 | right | without | 0.026 |
| FRN-D2-R152 | 1.33 +/- 0.26 | right | without | 0.026 |
| FRN-D2-R501 | 0.44 +/- 0.09 | right | without | 0.026 |
| FRN-D2-R102-G1 | 0.88 +/- 0.18 | right | with | 0.028 |
| FRN-D2-R152-G1 | 1.33 +/- 0.26 | right | with | 0.028 |
| FRN-D2-R501-G1 | 0.44 +/- 0.09 | right | with | 0.028 |
| FRN-D2-L102 | 0.88 +/- 0.18 | left | without | 0.026 |
| FRN-D2-L152 | 1.33 +/- 0.26 | left | without | 0.026 |
| FRN-D2-L501 | 0.44 +/- 0.09 | left | without | 0.026 |
| FRN-D2-L102-G1 | 0.88 +/- 0.18 | left | with | 0.028 |
| FRN-D2-L152-G1 | 1.33 +/- 0.26 | left | with | 0.028 |
| FRN-D2-L501-G1 | 0.44 +/- 0.09 | left | with | 0.028 |

¹ The indicated damping torque refers to a rotational speed of 20 rpm and an ambient temperature of 73 °F.

FRT-F2/K2 and FRN-F2/K2

For a long service life

Continuous Rotation

Damping torque 4.42 in-lbs to 26.55 in-lbs

The damping direction of FRT F2/K2 and FRN-F2/K2 is either the right, left or two-sided rotation. With a damping torque of up to 35.4 in-lbs, this product family can even handle heavy components. These ACE rotary dampers can decelerate directly in the pivot point or linear through a gear and gear rack. They are maintenance-free and ready-to-install.

Rotary damper products are built to metric specifications. For precise measurements, please refer to the ACE rotary damper catalog or contact an application expert.



Technical Data

Construction size: Ø 1.57 in-lbs

Rotational speed max.: 50 rpm

Lifetime: 50,000 cycles (1 cycle = 360° left-hand, 360° right-hand). Even after this time, the dampers still produce over approx. 80 % of their original damping moment. The service life may be significantly higher or lower, depending on the application.

Operating temperature range: 32 °F to 122 °F

Material: Outer body: Plastic ; Shaft: Steel

Mounting: In any position

Mounting information: No axial or radial forces may be induced via the shaft.

Safety information: Do not use rotary dampers as supports. Provide an external guide or support.

On request: Special designs available on request.

Characteristics

At 73 °F ambient temperature

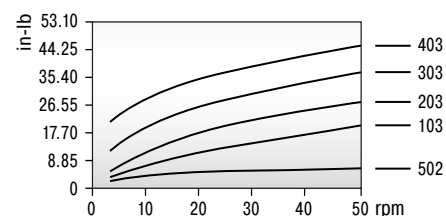

At 20 rpm rotational speed

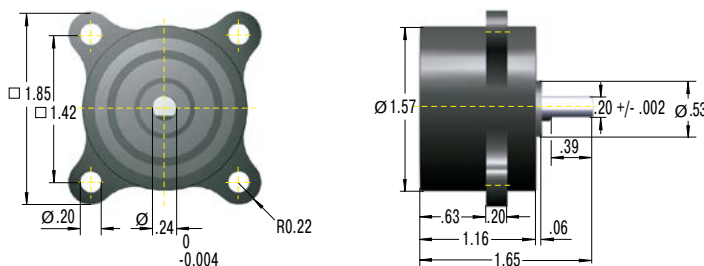
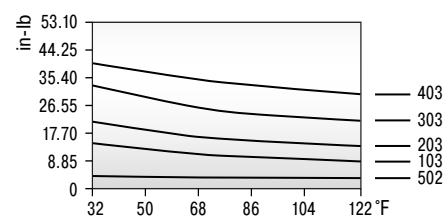

Performance

| TYPES | ¹ Damping torque in-lbs | Damping direction | Weight lbs |
|-------------|---------------------------------------|-------------------|---------------|
| FRT-K2-502 | 4.42 +/- 0.88 | bidirectional | 0.176 |
| FRT-K2-103 | 8.85 +/- 1.77 | bidirectional | 0.176 |
| FRT-F2-203 | 17.70 +/- 3.54 | bidirectional | 0.254 |
| FRT-F2-303 | 26.55 +/- 7.08 | bidirectional | 0.254 |
| FRT-F2-403 | 35.40 +/- 8.85 | bidirectional | 0.254 |
| FRN-K2-R502 | 4.42 +/- 0.88 | right | 0.126 |
| FRN-K2-R103 | 8.85 +/- 1.77 | right | 0.126 |
| FRN-F2-R203 | 17.70 +/- 3.54 | right | 0.198 |
| FRN-K2-L502 | 4.42 +/- 0.88 | left | 0.126 |
| FRN-K2-L103 | 8.85 +/- 1.77 | left | 0.126 |
| FRN-F2-L203 | 17.70 +/- 3.54 | left | 0.198 |

¹ The indicated damping torque refers to a rotational speed of 20 rpm and an ambient temperature of 73 °F.

FFD

Precise braking without oil

Continuous Rotation

Damping torque 0.89 in-lbs to 26.55 in-lbs

In comparison to other rotary dampers, the ACE FFD product family does not need any fluid to generate the damping torque, but rather works on the principle of friction. That means temperature or speed changes have virtually no influence on the damping torque. The FFD is available in two different body variants and two types of bearings. ACE rotary dampers are maintenance-free and ready-to-install.

Rotary damper products are built to metric specifications. For precise measurements, please refer to the ACE rotary damper catalog or contact an application expert.



Technical Data

Construction size: Ø 0.98 in to 1.18 in

Rotational speed max.: 30 rpm

Lifetime: 30,000 cycles (1 cycle = 360° left-hand, 360° right-hand). Even after this time, the dampers still produce over approx. 80 % of their original damping moment. The service life may be significantly higher or lower, depending on the application.

Operating temperature range: 14 °F to 140 °F

Material: Outer body: Plastic

Mounting: In any position

Information to the shaft: Ø +0 / -0.001
Hardness > HRC55, surface smoothness R_z < 1µm

Mounting information: Turn the shaft in the opposite direction to the brake direction to avoid damaging the freewheel mount. No axial or radial forces may be induced via the shaft.

Safety information: Do not use rotary dampers as supports. Provide an external guide or support.

On request: Special designs available on request.

Ordering Example

FFD-25-FS-L-102

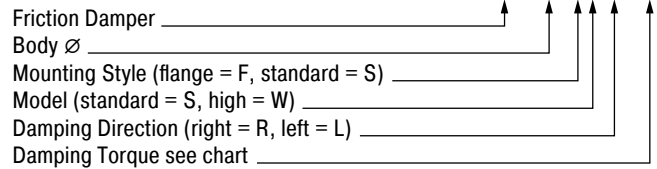

Complete details required when ordering

- Damping torque 102 = 0.89 lbs
- Damping torque 502 = 4.43 lbs
- Damping torque 103 = 8.85 lbs
- Damping torque 153 = 13.28 lbs
- Damping torque 203 = 17.70 lbs
- Damping torque 253 = 22.13 lbs
- Damping torque 303 = 26.55 lbs
- Note dimension C.

Model Type Prefix

- FS = Mounting Style with Flange, Model standard
- FW = Mounting Style with Flange, Model high
- SS = Mounting Style Standard, Model standard
- SW = Mounting Style Standard, Model high
- Combinations with W for higher damping torque.

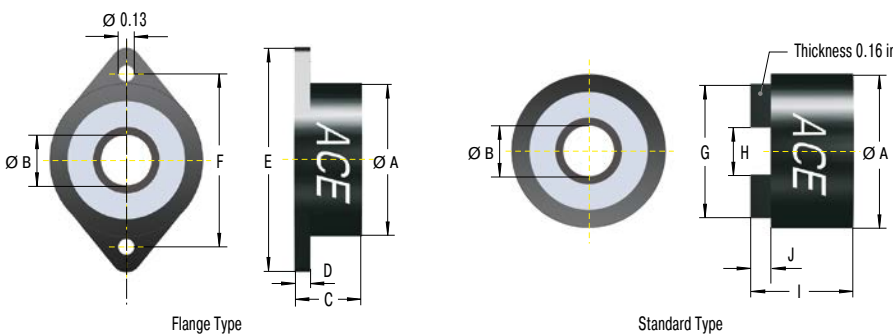

Performance and Dimensions

| TYPES | ¹ Damping torque | | Damping direction | Model | A | B | C | D | E | F | G | H | I | J | Weight lbs |
|----------|-------------------------|--|-------------------|-------|------|------|------|------|------|------|------|------|------|------|---------------|
| | in-lbs | | | | inch | inch | inch | inch | inch | inch | inch | inch | inch | inch | |
| FFD-25SS | 0.88/4.42/8.85 | | right or left | SS | 0.98 | 0.24 | 0.51 | 0.12 | 1.65 | 1.34 | 0.83 | 0.24 | 0.63 | 0.15 | 0.026 |
| FFD-28SS | 0.88/4.42/8.85 | | right or left | SS | 1.10 | 0.31 | 0.51 | 0.12 | 1.65 | 1.42 | 0.94 | 0.32 | 0.63 | 0.15 | 0.031 |
| FFD-30SS | 0.88/4.42/8.85/13.27 | | right or left | SS | 1.18 | 0.39 | 0.51 | 0.12 | 1.81 | 1.5 | 1.02 | 0.4 | 0.63 | 0.15 | 0.035 |
| FFD-25FS | 0.88/4.42/8.85 | | right or left | FS | 0.98 | 0.24 | 0.51 | 0.12 | 1.65 | 1.34 | 0.83 | 0.24 | 0.63 | 0.15 | 0.029 |
| FFD-28FS | 0.88/4.42/8.85 | | right or left | FS | 1.10 | 0.31 | 0.75 | 0.12 | 1.65 | 1.42 | 0.94 | 0.32 | 0.63 | 0.15 | 0.031 |
| FFD-30FS | 0.88/4.42/8.85/13.27 | | right or left | FS | 1.18 | 0.39 | 0.51 | 0.12 | 1.81 | 1.5 | 1.02 | 0.4 | 0.63 | 0.15 | 0.037 |
| FFD-25SW | 8.85/13.27/17.70 | | right or left | SW | 0.98 | 0.24 | 0.75 | 0.12 | 1.65 | 1.34 | 0.83 | 0.24 | 0.87 | 0.15 | 0.051 |
| FFD-28SW | 8.85/13.27/17.70 | | right or left | SW | 1.10 | 0.31 | 0.75 | 0.12 | 1.65 | 1.42 | 0.94 | 0.32 | 0.87 | 0.15 | 0.055 |
| FFD-30SW | 13.27/17.70/22.13/26.55 | | right or left | SW | 1.18 | 0.39 | 0.75 | 0.12 | 1.81 | 1.5 | 1.02 | 0.4 | 0.87 | 0.15 | 0.066 |
| FFD-25FW | 8.85/13.27/17.70 | | right or left | FW | 0.98 | 0.24 | 0.75 | 0.12 | 1.65 | 1.34 | 0.83 | 0.24 | 0.87 | 0.15 | 0.053 |
| FFD-28FW | 8.85/13.27/17.70 | | right or left | FW | 1.10 | 0.31 | 0.75 | 0.12 | 1.65 | 1.42 | 0.94 | 0.32 | 0.87 | 0.15 | 0.060 |
| FFD-30FW | 13.27/17.70/22.13/26.55 | | right or left | FW | 1.18 | 0.39 | 0.75 | 0.12 | 1.81 | 1.5 | 1.02 | 0.4 | 0.87 | 0.15 | 0.068 |

¹ The indicated damping torque refers to a rotational speed of 20 rpm and an ambient temperature of 73 °F.

FDT

The flat disc brake for two-sided damping

Continuous Rotation

Damping torque 4.43 in-lbs to 79.66 in-lbs

The damping direction of the flat constructive ACE rotary damper FDT with robust steel body is two-sided rotation. It can brake directly in the pivot point of the square receptacle. ACE rotary dampers are maintenance-free and ready-to-install.

Rotary damper products are built to metric specifications. For precise measurements, please refer to the ACE rotary damper catalog or contact an application expert.



Technical Data

Construction size: Ø 1.85 in-lbs to 2.76 in-lbs

Rotational speed max.: 50 rpm

Lifetime: 50,000 cycles (1 cycle = 360° left-hand, 360° right-hand). Even after this time, the dampers still produce over approx. 80 % of their original damping moment. The service life may be significantly higher or lower, depending on the application.

Operating temperature range: 14 °F to 140 °F

Material: Outer body: Steel ; Output shaft sleeve: Nylon

Mounting: In any position

Mounting information: No axial or radial forces may be induced via the shaft.

Safety information: Do not use rotary dampers as supports. Provide an external guide or support.

On request: Special designs available on request.

Characteristics

At 73 °F ambient temperature

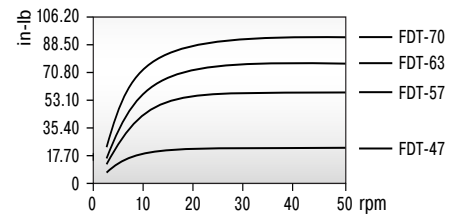

At 20 rpm rotational speed

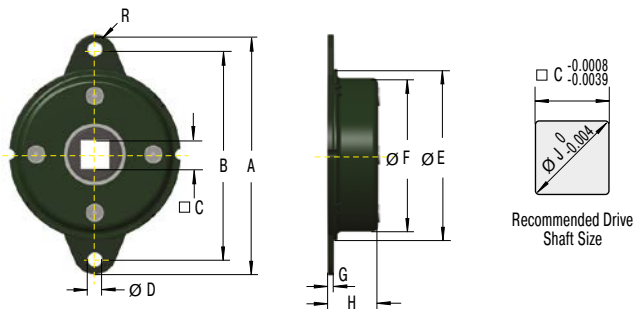
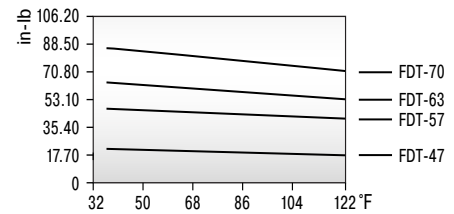

Performance and Dimensions

| TYPES | ¹ Damping torque in-lbs | Damping direction | A inch | B inch | C inch | D inch | E inch | F inch | G inch | H inch | R inch | J inch | Weight lbs |
|--------|---------------------------------------|-------------------|-----------|-----------|-----------|-----------|-----------|-----------|-----------|-----------|-----------|-----------|---------------|
| FDT-47 | 17.70 +/- 2.66 | bidirectional | 2.55 | 2.20 | 0.31 | 0.18 | 1.85 | 1.68 | 0.06 | 0.40 | 4.5 | 0.40 | 0.110 |
| FDT-57 | 41.60 +/- 4.43 | bidirectional | 3.11 | 2.68 | 0.40 | 0.22 | 2.24 | 2.06 | 0.06 | 0.44 | 5.5 | 0.50 | 0.165 |
| FDT-63 | 59.30 +/- 6.20 | bidirectional | 3.50 | 3.00 | 0.49 | 0.25 | 2.48 | 2.30 | 0.06 | 0.44 | 6.5 | 0.67 | 0.209 |
| FDT-70 | 77 +/- 7.08 | bidirectional | 3.74 | 3.23 | 0.49 | 0.25 | 2.76 | 2.57 | 0.06 | 0.44 | 6.5 | 0.67 | 0.243 |

¹ The indicated damping torque refers to a rotational speed of 20 rpm and an ambient temperature of 73 °F.

FDN

The flat disc brake for one direction of rotation

Continuous Rotation

Damping torque 4.43 in-lbs to 97.36 in-lbs

The damping direction of the flat, strong FDN rotary dampers with steel body can be either right or left rotation. They can brake directly in the pivot point. ACE rotary dampers are maintenance-free and ready-to-install.

Rotary damper products are built to metric specifications. For precise measurements, please refer to the ACE rotary damper catalog or contact an application expert.



Technical Data

Construction size: Ø 1.85 in to 2.76 in

Rotational speed max.: 50 rpm

Lifetime: 50,000 cycles (1 cycle = 360° left-hand, 360° right-hand). Even after this time, the dampers still produce over approx. 80 % of their original damping moment. The service life may be significantly higher or lower, depending on the application.

Operating temperature range: 14 °F to 140 °F

Material: Outer body: Steel ; Output shaft sleeve: nylon with metal freewheel

Mounting: In any position

Information to the shaft:

FDN-47: Ø 0.24 +0 / -0.001

FDN-57 to FDN-70: Ø 0.39 +0 / -0.001

Hardness > HRC55, surface smoothness $R_z < 1 \mu\text{m}$

Mounting information: Turn the shaft in the opposite direction to the brake direction to avoid damaging the freewheel mount. No axial or radial forces may be induced via the shaft.

Safety information: Do not use rotary dampers as supports. Provide an external guide or support.

On request: Special designs available on request.

Characteristics

At 73 °F ambient temperature

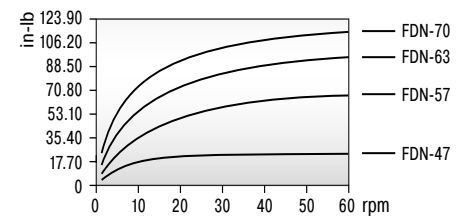

At 20 rpm rotational speed

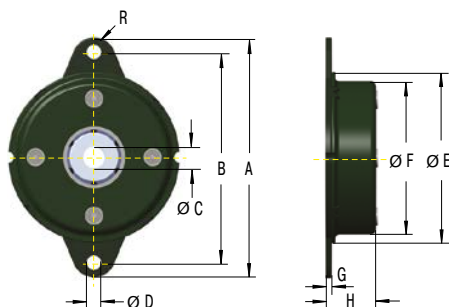
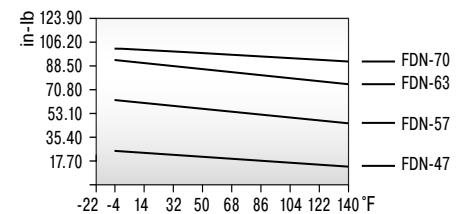

Performance and Dimensions

| TYPES | ¹ Damping torque | | Damping direction | A | B | C | D | E | F | G | H | R | Weight |
|----------|-----------------------------|--|-------------------|------|------|------|------|------|------|------|------|------|--------|
| | in-lbs | | | | | | | | | | | | |
| FDN-47-R | 17.70 +/- 2.66 | | right | 2.56 | 2.20 | 0.24 | 0.18 | 1.85 | 1.68 | 0.06 | 0.40 | 0.18 | 0.119 |
| FDN-57-R | 48.68 +/- 2.66 | | right | 3.11 | 2.70 | 0.40 | 0.22 | 2.24 | 2.06 | 0.06 | 0.55 | 0.22 | 0.209 |
| FDN-63-R | 75.23 +/- 7.08 | | right | 3.50 | 3.00 | 0.40 | 0.25 | 2.48 | 2.30 | 0.06 | 0.55 | 0.26 | 0.254 |
| FDN-70-R | 97.36 +/- 8.85 | | right | 3.74 | 3.23 | 0.40 | 0.25 | 2.76 | 2.57 | 0.06 | 0.51 | 0.26 | 0.298 |
| FDN-47-L | 17.70 +/- 2.66 | | left | 2.56 | 2.20 | 0.24 | 0.18 | 1.85 | 1.68 | 0.06 | 0.41 | 0.18 | 0.119 |
| FDN-57-L | 48.68 +/- 2.66 | | left | 3.11 | 2.70 | 0.40 | 0.22 | 2.24 | 2.06 | 0.06 | 0.55 | 0.22 | 0.209 |
| FDN-63-L | 75.23 +/- 7.08 | | left | 3.50 | 3.00 | 0.40 | 0.25 | 2.48 | 2.30 | 0.06 | 0.55 | 0.26 | 0.254 |
| FDN-70-L | 97.36 +/- 8.85 | | left | 3.74 | 3.23 | 0.40 | 0.25 | 2.76 | 2.57 | 0.06 | 0.51 | 0.26 | 0.298 |

¹ The indicated damping torque refers to a rotational speed of 20 rpm and an ambient temperature of 73 °F.

FYN-P1

Small diameter, large damping torques

Partial Rotation Angle

Damping torque 8.85 in-lbs to 15.93 in-lbs



The damping direction of the rotary damper FYN-P1 can be either right or left rotation. The dampers can be directly mounted in the pivot point. During each reverse movement of the unilateral decelerating versions there is a certain return damping torque that depends on the size. Differentiation of the damping direction through the coloured shaft. ACE rotary dampers are maintenance-free and ready-to-install.

Rotary damper products are built to metric specifications. For precise measurements, please refer to the ACE rotary damper catalog or contact an application expert.

Technical Data

Construction size: Ø 0.73 in-lbs

Lifetime: 50,000 cycles, even after this time, the dampers still produce over approx. 80 % of their original damping moment. The service life may be significantly higher or lower, depending on the application.

Operating temperature range: 23 °F to 122 °F

Material: Outer body, Shaft: Plastic

Mounting: In any position

Rotation angle max.: 115°

Note: Damping direction: Right hand damping = damping action in clockwise direction (when looking onto the output shaft or output shaft sleeve, depending on the damper type). A play of approx. 5° can occur at the beginning of movement.

Mounting information: No axial or radial forces may be induced via the shaft.

Safety information: Do not use rotary dampers as supports. Provide an external guide or support.

On request: Special designs available on request.

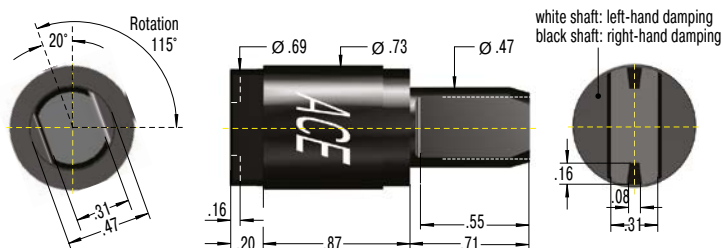

Performance

| TYPES | Damping torque in-lbs | Return Damping Torque in-lbs | Damping direction | Weight lbs |
|-------------|--------------------------|---------------------------------|-------------------|---------------|
| FYN-P1-R103 | 8.85 | 2.65 | right | 0.023 |
| FYN-P1-R153 | 13.27 | 4.42 | right | 0.023 |
| FYN-P1-R183 | 15.93 | 7.08 | right | 0.023 |
| FYN-P1-L103 | 8.85 | 2.65 | left | 0.023 |
| FYN-P1-L153 | 13.27 | 4.42 | left | 0.023 |
| FYN-P1-L183 | 15.93 | 7.08 | left | 0.023 |

Issue 04.2018 – Specifications subject to change

FYN-N1

Small diameter, large damping torques

Partial Rotation Angle

Damping torque 8.85 in-lbs to 26.55 in-lbs

The damping direction of the rotary damper FYN-N1 can be either right or left rotation. The dampers can be directly mounted in the pivot point. During each reverse movement of the unilateral decelerating versions there is a certain return damping torque that depends on the size. Differentiation of the damping direction through coloured end cap. ACE rotary dampers are maintenance-free and ready-to-install.

Rotary damper products are built to metric specifications. For precise measurements, please refer to the ACE rotary damper catalog or contact an application expert.



Technical Data

Construction size: Ø 0.79 in

Lifetime: 50,000 cycles, even after this time, the dampers still produce over approx. 80 % of their original damping moment. The service life may be significantly higher or lower, depending on the application.

Operating temperature range: 23 °F to 122 °F

Material: Outer body, Shaft: Plastic

Mounting: In any position

Rotation angle max.: 110°

Note: Damping direction: Right hand damping = damping action in clockwise direction (when looking onto the output shaft or output shaft sleeve, depending on the damper type). A play of approx. 5° can occur at the beginning of movement.

Mounting information: No axial or radial forces may be induced via the shaft.

Safety information: Do not use rotary dampers as supports. Provide an external guide or support.

On request: Special designs available on request.

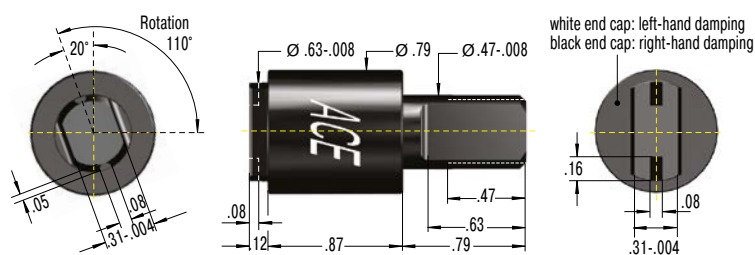

Performance

| TYPES | Damping torque in-lbs | Return Damping Torque in-lbs | Damping direction | Weight lbs |
|-------------|--------------------------|---------------------------------|-------------------|---------------|
| FYN-N1-R103 | 8.85 | 1.77 | right | 0.026 |
| FYN-N1-R203 | 17.70 | 3.54 | right | 0.026 |
| FYN-N1-R253 | 22.13 | 3.54 | right | 0.026 |
| FYN-N1-R303 | 26.55 | 7.08 | right | 0.026 |
| FYN-N1-L103 | 8.85 | 1.77 | left | 0.026 |
| FYN-N1-L203 | 17.70 | 3.54 | left | 0.026 |
| FYN-N1-L253 | 22.13 | 3.54 | left | 0.026 |
| FYN-N1-L303 | 26.55 | 7.08 | left | 0.026 |

FYN-U1

Small, strong and very robust

Partial Rotation Angle

Damping torque 17.70 in-lbs to 26.55 in-lbs

The damping direction of the rotary damper FYN-U1 can be either right or left rotation. The dampers can be directly mounted in the pivot point. The body is made of especially robust die-cast zinc. During each reverse movement of the unilateral decelerating versions there is a certain return damping torque that depends on the size. ACE rotary dampers are maintenance-free and ready-to-install.

Rotary damper products are built to metric specifications. For precise measurements, please refer to the ACE rotary damper catalog or contact an application expert.



Technical Data

Construction size: Ø 0.63 in

Lifetime: 50,000 cycles, even after this time, the dampers still produce over approx. 80 % of their original damping moment. The service life may be significantly higher or lower, depending on the application.

Operating temperature range: 23 °F to 122 °F

Material: Outer body, Shaft: Zinc die-cast

Mounting: In any position

Rotation angle max.: 115°

Note: Damping direction: Right hand damping = damping action in clockwise direction (when looking onto the output shaft or output shaft sleeve, depending on the damper type). A play of approx. 5° can occur at the beginning of movement.

Mounting information: No axial or radial forces may be induced via the shaft.

Safety information: Do not use rotary dampers as supports. Provide an external guide or support.

On request: Special designs available on request.

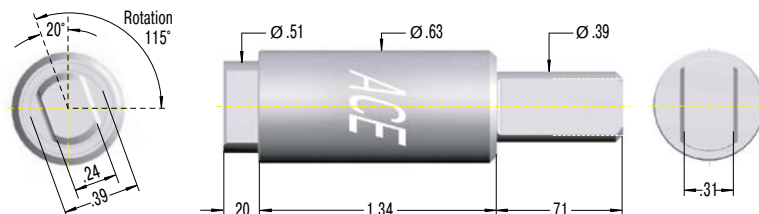

Performance

| TYPES | Damping torque in-lbs | Return Damping Torque in-lbs | Damping direction | Weight lbs |
|-------------|--------------------------|---------------------------------|-------------------|---------------|
| FYN-U1-R203 | 17.70 | 3.54 | right | 0.088 |
| FYN-U1-R253 | 22.13 | 3.54 | right | 0.088 |
| FYN-U1-R303 | 26.55 | 7.08 | right | 0.088 |
| FYN-U1-L203 | 17.70 | 3.54 | left | 0.088 |
| FYN-U1-L253 | 22.13 | 3.54 | left | 0.088 |
| FYN-U1-L303 | 26.55 | 7.08 | left | 0.088 |

FYN-S1

The flat damper for constant component protection

Partial Rotation Angle

Damping torque 44.25 in-lbs to 88.51 in-lbs

The self-compensating FYN-S1 rotary damper with zinc die-cast body provides a constant sequence of movement for different masses. The damping direction can be either right or left rotation. During each reverse movement of the unilateral decelerating versions there is a certain return damping torque that depends on the size. ACE rotary dampers are maintenance-free and ready-to-install.

Rotary damper products are built to metric specifications. For precise measurements, please refer to the ACE rotary damper catalog or contact an application expert.



Technical Data

Construction size: Ø 2.36 in

Lifetime: 50,000 cycles, even after this time, the dampers still produce over approx. 80 % of their original damping moment. The service life may be significantly higher or lower, depending on the application.

Operating temperature range: 23 °F to 122 °F

Material: Outer body: Zinc die-cast ; Output shaft sleeve: Plastic

Mounting: In any position

Rotation angle max.: 130°

Note: Damping direction: Right hand damping = damping action in clockwise direction (when looking onto the output shaft or output shaft sleeve, depending on the damper type). A play of approx. 5° can occur at the beginning of movement.

Mounting information: No axial or radial forces may be induced via the shaft.

Safety information: Do not use rotary dampers as supports. Provide an external guide or support.

On request: Special designs available on request.

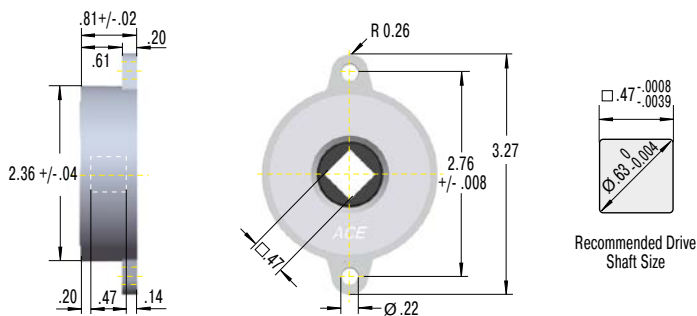

Performance

| TYPES | Damping torque in-lbs | Return Damping Torque in-lbs | Damping direction | Weight lbs |
|-------------|--------------------------|---------------------------------|-------------------|---------------|
| FYN-S1-R104 | 44.25 - 88.51 | 13.28 | right | 0.485 |
| FYN-S1-L104 | 44.25 - 88.51 | 13.28 | left | 0.485 |

FYT-H1 and FYN-H1

Specifically adjustable, strong braking force

Partial Rotation Angle, Adjustable

Damping torque 77.70 in-lbs to 88.51 in-lbs

The damping direction of the adjustable FYT-H1 and FYN-H1 can be right, left or two-sided rotation. During each reverse movement of the unilateral decelerating versions there is a certain return damping torque that depends on the size. The brakes have a particularly robust zinc die-cast body and shafts made of steel. ACE rotary dampers are maintenance-free and ready-to-install.

Rotary damper products are built to metric specifications. For precise measurements, please refer to the ACE rotary damper catalog or contact an application expert.



Technical Data

Construction size: Ø 1.75 in

Lifetime: 50,000 cycles, even after this time, the dampers still produce over approx. 80 % of their original damping moment. The service life may be significantly higher or lower, depending on the application.

Operating temperature range: 23 °F to 122 °F

Material: Outer body: Zinc die-cast ; Shaft: Steel

Mounting: In any position

Rotation angle max.: 105°

Maximum side load: 11.24 lb

Note: Damping direction: Right hand damping = damping action in clockwise direction (when looking onto the output shaft or output shaft sleeve, depending on the damper type). A play of approx. 5° can occur at the beginning of movement.

Safety information: Do not use rotary dampers as supports. Provide an external guide or support.

On request: Special designs available on request.

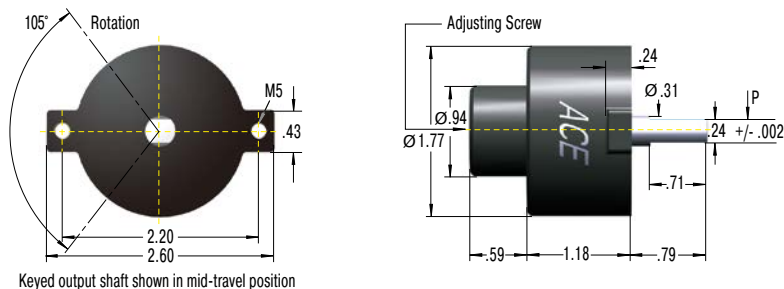

Performance

| TYPES | Damping torque in-lbs | Return Damping Torque in-lbs | Damping direction | Weight lbs |
|----------|--------------------------|---------------------------------|-------------------|---------------|
| FYT-H1 | 17.70 - 88.51 | 4.43 | bidirectional | 0.516 |
| FYN-H1-R | 17.70 - 88.51 | 4.43 | right | 0.516 |
| FYN-H1-L | 17.70 - 88.51 | 4.43 | left | 0.516 |

FYT-LA3 and FYN-LA3

Adjustable high performance

Partial Rotation Angle, Adjustable

Damping torque 35.40 in-lbs to 354.04 in-lbs

The damping direction of this adjustable high-performance rotary damper can be right, left or two-sided rotation. During each reverse movement of the unilateral decelerating versions there is a certain return damping torque that depends on the size. The brakes have a particularly robust zinc die-cast body and shafts made of steel. ACE rotary dampers are maintenance-free and ready-to-install.

Rotary damper products are built to metric specifications. For precise measurements, please refer to the ACE rotary damper catalog or contact an application expert.



Technical Data

Construction size: Ø 3.15 in

Lifetime: 50,000 cycles, even after this time, the dampers still produce over approx. 80 % of their original damping moment. The service life may be significantly higher or lower, depending on the application.

Operating temperature range: 23 °F to 122 °F

Material: Outer body: Zinc die-cast ; Shaft: Steel

Mounting: In any position

Rotation angle max.: 210°

Maximum side load: 45 lb

Note: Damping direction: Right hand damping = damping action in clockwise direction (when looking onto the output shaft or output shaft sleeve, depending on the damper type). A play of approx. 5° can occur at the beginning of movement.

Safety information: Do not use rotary dampers as supports. Provide an external guide or support.

On request: Special designs available on request.

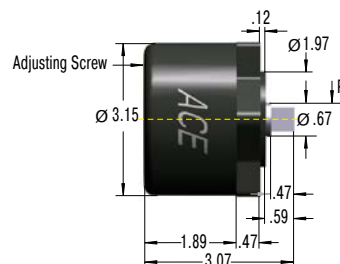
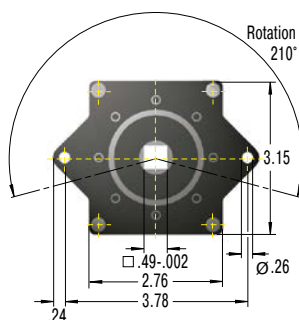

Performance

| TYPES | Damping torque in-lbs | Return Damping Torque in-lbs | Damping direction | Weight lbs |
|-----------|--------------------------|---------------------------------|-------------------|---------------|
| FYT-LA3 | 35.40 - 354.04 | 35.40 | bidirectional | 3.793 |
| FYN-LA3-R | 35.40 - 354.04 | 35.40 | right | 3.809 |
| FYN-LA3-L | 35.40 - 354.04 | 35.40 | left | 3.809 |

Calculation Example

Damping of a Lid

To select an appropriate rotary damper for the adjacent calculation example, the length and the weight or the center of gravity of the flap have to be known. After determining the value of the max. torque at an unfavorable angle of the flap, select the appropriate damper.

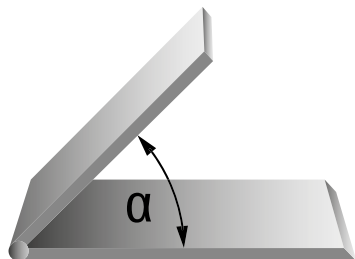

Calculation Steps

1. Calculate max. torque damper will be exposed to (with example shown on the left max. torque is at $\alpha = 0^\circ$).
2. Decide upon rotation speed desired.
3. Choose a rotary damper that can handle the torque calculated above.
4. With the aid of the damper performance curves, check if the r.p.m. given at your torque corresponds to the desired closing speed of the lid.
5. If the r.p.m. is too high – choose a damper with a higher torque rating.
If the r.p.m. is too low – choose a damper with a lower torque rating.

Closing Torque
 $T = L / 2 \cdot M \cdot g \cdot \cos \alpha$
 (L / 2 = center of gravity)

M Mass of a lid [lb]
L Length of lid from pivot [in]
n Rotation speed [r.p.m.]

Special Accessories

Toothed Racks for Rotary Dampers with Gear

Rotary dampers with gears are available in four standard modules which can be optionally supplied with plastic toothed racks as accessories.

M0.5, M0.6, M0.8, M1.0 Toothed Rack

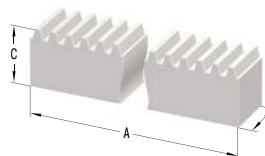

M0.8P Toothed Rack

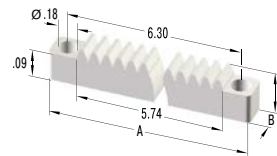

Delivery Notes

Delivery form: Toothed plastic racks with modules 0.5 to 1.0 availables ex stock

On request: Toothed metal racks

| Dimensions | | | | |
|------------|-----------|-----------|-----------|------------------|
| TYPES | A inch | B inch | C inch | Model |
| M0.5 | 9.84 | 0.16 | 0.18 | rigid, milled |
| M0.6 | 9.84 | 0.16 | 0.24 | rigid, milled |
| M0.8 | 9.84 | 0.24 | 0.31 | rigid, milled |
| M0.8P | 6.69 | 0.31 | 0.16 | flexible, milled |
| M1.0 | 9.84 | 0.35 | 0.35 | rigid, milled |
| M1.0 | 19.69 | 0.39 | 0.39 | rigid, milled |

Mounting Information

The rotary axis, square receptacles or free-wheel receptacles are not designed for lateral loads. An external guide or bearing support is fundamentally recommended.

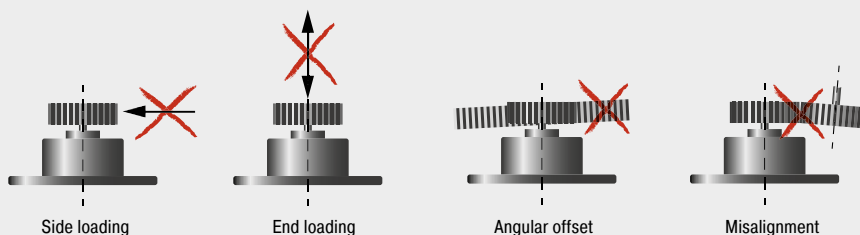

Application Examples

FDT

Finger protection when cutting bread

To exclude the possibility of injury when using bread slicing machines on self-service counters, the automatic bread slicing process does not start until the flap of the modern machine is closed. To simplify the operation and to thereby increase acceptance of the self-slicing principle among users, two-way rotary dampers of the type FDT-57 ensure smooth opening and closing of the door. Even when rotary dampers must act only in one direction, ACE has appropriate variants readily available.

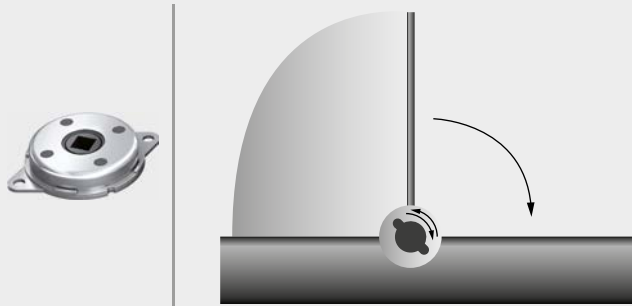

Protective flaps secured with rotary dampers: the simple operation of bread slicing machines can then be easily managed by hand
Daub Bakery Machinery BV, 5050 AB Goirle, Netherlands

FDN-R

Invisible protection for cooker hoods

For ergonomic handling, modern cooker hoods can be driven by a motor into an up position and then down again. When driven downwards, an AC load can result in a total loss through current being fed back into the voltage source. One of the tasks of the FDN-63-R ACE rotary damper is to prevent this. The modern machine elements are also built to provide protection against motor failure. Sliding the hood down too quickly could lead to further costly damage to the hood and the ceiling console and even cause personal injury.



Rotary dampers in high-end cooker hoods safeguard the protection of drive units and protect chefs, even during power failures
berbel Ablufttechnik GmbH, 48432 Rheine, Germany

Vibration Control

Vibration-Isolating Pads, Rubber-Metal Isolators
Low Frequency Pneumatic Leveling Mounts



Isolate Unwanted Vibrations Effectively

Unique variety

This ACE product group includes innovative solutions to provide customers with the best assistance in isolation technology and vibration isolation. These machine elements are also distinguished by their light design and wide variety.

The product range extends from extremely low frequency isolating pneumatic leveling mounts to ready-to-install rubber-metal isolators and damping pads. With this portfolio, ACE is capable of offering you customized vibration isolation for almost any application.



Vibration Isolation

Noise reduction and vibration isolation are becoming more and more important in our daily lives. This applies in particular to the workplace and the environments around production companies.

Preventing noise emissions or harmful vibrations is not only a necessity required by noise protection and occupational health and safety legislation; their sources must also be localized by means of targeted analysis in order to develop suitable improvement measures for achieving increased production quality. A second by-product of vibrations are their effects on the surrounding production environment and any measuring and testing facilities that may be in use.

Advantages

- improved working conditions for people and the environment
- more accurate production tolerances and increased product quality
- competitive and cost advantages thanks to lower reject rate in production
- increased production speed thanks to increased maximum machine dynamics
- longer tool and machine life thanks to lower stress
- faster and more accurate measuring results

For detailed information, see our ACEolator catalog



Rubber-Metal Isolators

Ready-to-install isolators for quick selection

Rubber-metal isolators and machine feet are supplied ready-to-install and are used in a large variety of vibration isolation applications. Common applications are engines, compressors, transfer systems, machines, fans and blowers.



LEV

Leveling Mounts (height-adjustable machine feet)

Secure, adjustable stabilization for all types of machines, transfer systems, assembly stations, etc.



CM

Cup Mounts (cup elements)

For isolating machinery and equipment. Fail-safe isolators for all axes in any installation position. Application examples: compressors, off-road vehicles, engines, fans, etc.



COM

Compression Mounts (pre-tensioned high-performance bearing surface)

Vertically acting isolators for machinery and equipment. Applications include: blowers, compressors, motors, generators, presses, etc.



AAM

All Attitude Mounts (vibration-isolating fasteners)

Maintenance free isolators for decoupling parts and components in electronics, aerospace, the military, medicine, transfer systems, etc.



SFM

Stable Flex Mounts (stable machine feet)

Extremely rugged and maintenance-free isolators, e.g. for marine applications, for diesel generators, in power generation or in off-road vehicles.



BM

Bubble Mounts (low-frequency vibration isolators)

For protecting small devices and electronic components, e.g. in medical technology, aerospace, electronic systems or computers.



UMO

Universal Mounts (universal connection isolators)

Maintenance-free connection isolators which can be implemented both radially and axially. Application examples: conveying systems, machinery and equipment, off-road, oil and gas industry, control systems, etc.



FL

Flex Locs (quick fastening elements)

Simple, efficient components with versatile applications as isolating fasteners for decoupling structure-borne sound in enclosures, housings, equipment and machinery. For application in mechanical engineering, in buildings, vehicles, or navigation.

Vibration-Isolating Pads

Customized insulation technology through cutting and combining

A wide range of applications such as machine foundations, supports, decoupling elements, pipelines and subsequently protected machines require tailor-made solutions. Here with its product range of vibration insulating pads ACE offers comprehensive possibilities for insulation. The products are manufactured and supplied either as standard pads or as drawing parts according to customer request.



SLAB

Universal Damping Pads

For application on foundations for plants and machines, compressors, in pump stations, generators, for insulations, measuring tables, buildings, etc.



CEL

Low-Frequency Damping Pads

For use in foundations, buildings, transport routes, bridges, stairs, test benches, pump stations, generators, compressors, machines, etc.



PAD

Rugged Fiber and Elastomer Pads

For isolating and protecting foundations, such as presses, plants, machines, as well as for use in pump stations, crane runways, bridges and heavy-duty applications

Application overview

| Type | Machines | Transfer systems | Construction Transport | Blower Fan | Foundations | Control units Electrical systems | Off-road vehicles |
|---------------------------------|----------|------------------|------------------------|------------|-------------|----------------------------------|-------------------|
| Rubber-Metal Isolators | | | | | | | |
| LEV | ■ | ■ | | ■ | | | |
| CM | ■ | | ■ | ■ | | | ■ |
| COM | ■ | ■ | | ■ | | ■ | |
| AAM | | ■ | ■ | | | ■ | ■ |
| SFM | | | ■ | | | | ■ |
| BM | | | | ■ | | ■ | |
| UMO | ■ | ■ | ■ | | | ■ | ■ |
| FL | ■ | | ■ | | | ■ | |
| Vibration-Isolating Pads | | | | | | | |
| SLAB | ■ | ■ | ■ | ■ | ■ | | |
| CEL | ■ | ■ | ■ | ■ | ■ | | |
| PAD | ■ | | ■ | | ■ | | ■ |
| Air Spring Elements | | | | | | | |
| PLM | ■ | | | | | | |
| PAL | | | | | ■ | | |

Issue 04.2018 – Specifications subject to change

Low Frequency Pneumatic Leveling Mounts

Highly efficient insulation – it can hardly get any better

Everywhere perfect isolation of measuring tables, test equipment and high-performance machines are important the low frequency pneumatic leveling mounts PLM and PAL are a good choice. On request a detailed system analysis will be carried out at the customer and the perfect solution will be developed.



PLM

Pneumatic Air Spring Elements

For an efficient isolation of measuring equipment, high-speed presses and machines.



PAL-3 to PAL-9

Small Size Air Spring Elements

The perfect leveling and isolation system for smaller constructions that require precision and flexibility. Available in the system with many accessories.



PAL-18 to PAL-1000

Big Air Spring Elements with Automatic Level Controls

Isolation against disruptive vibrations and level-adjustment for test and measuring equipment. Isolating at extremely low-frequencies, these components are used in the automotive industry and in aerospace engineering.

More information about vibration control can be found in our special catalog and on our website [www.acecontrols.com / Downloads](http://www.acecontrols.com/Downloads)

Issue 04.2018 – Specifications subject to change

| Engines Generators | Compressors | Oil and gas industry | Aerospace engineering | Presses | Medicine | Measuring tables | Test benches | Type |
|---------------------------------|-------------|-------------------------|--------------------------|---------|----------|---------------------|-----------------|------|
| Rubber-Metal Isolators | | | | | | | | |
| | | | | ■ | | | | LEV |
| ■ | ■ | ■ | ■ | | | | | CM |
| ■ | ■ | | | ■ | | | | COM |
| ■ | | | ■ | | ■ | | | AAM |
| ■ | ■ | | | | | | | SFM |
| | | | | | ■ | | | BM |
| ■ | ■ | ■ | ■ | | | | | UMO |
| ■ | ■ | | | | | | | FL |
| Vibration-Isolating Pads | | | | | | | | |
| | | ■ | | ■ | ■ | ■ | | SLAB |
| | | ■ | | ■ | ■ | ■ | ■ | CEL |
| | | ■ | | ■ | | | | PAD |
| Air Spring Elements | | | | | | | | |
| | | | | ■ | ■ | ■ | ■ | PLM |
| | | | ■ | | | ■ | ■ | PAL |

Safety Products

**Safety Shock Absorbers, Safety Dampers
Clamping Elements**



Safety Shock Absorbers

Perfect protection for the worst case scenario

As an alternative to the standard shock absorber, Safety shock absorbers are the tried and tested low cost method of preventing those occasional emergency stops. Designed for occasional use, they primarily serve as reliable, effective protection in emergency stop situations.

The maintenance-free and ready-to-install machine elements are characterized in every respect by the well-known high ACE quality and maximum energy absorption of up to 4,250,000 in-lbs/Cycle. This means, in the product family SCS33 up to SCS64 a service life of up to 1,000 full load emergency cycles is achieved.

Safety shock absorbers from ACE are available in a large choice with strokes of 0.91 in to 47.24 in, and the arrangement of orifice pattern can be calculated and produced specifically to the customer's requirements and depending on the application.



Safety Shock Absorbers



SCS33 to SCS64

Page 262

Self-Compensating or Optimized Characteristic
Industry design with high energy absorption

Finishing and processing centers, Conveyor systems, Portal systems, Test stations



SCS38 to SCS63

Page 266

High Rack Damper, Optimized Characteristic
Low reaction forces with long strokes

Shelf storage systems, Heavy load applications, Conveyor systems, Conveyor systems



CB63 to CB160

Page 270

Crane Installations, Optimized Characteristic

High resetting forces with gas pressure accumulator

Heavy load applications, Heavy load applications, Conveyor systems, Portal systems



EB63 to EB160

Page 272

Crane Installations, Optimized Characteristic

Low return force with spring assembly

Heavy load applications, Heavy load applications, Conveyor systems, Portal systems

Top machine protection

Latest damping technology

Attractive cost-benefit ratio

Maximum strokes

Wide application spectrum

Robust design



SCS33 to SCS64

Industry design with high energy absorption

Self-Compensating or Optimized Characteristic
Energy capacity 2,744 in-lbs/Cycle to 159,313 in-lbs/Cycle
Stroke 0.91 in to 5.91 in

Effective emergency stop: the ACE safety shock absorbers from the SCS33 to SCS64 product family are based on the innovative technology of the successful MAGNUM range shock absorbers. They are also maintenance-free and ready-to-install.

ACE uses our proprietary custom calculation program to design each shock absorber for the specific customer application. Customization helps reduce the risk of crashes and incorrect product sizing. Due to the optimized characteristic curve for the respective application, the energy absorption of these hydraulic machine elements can be increased to more than twice the level of the MAGNUM model of ACE industrial shock absorber per stroke. Users benefit from a service life of up to 1,000 full load emergency cycles with a very good price-performance ratio. Their compact design in sizes M33x1.5 to M64x2 makes them easy to integrate into current applications.

These slimline, high-performance safety shock absorbers are only designed for emergency stop situations. They can be used for a number of tasks in gantries and conveyor systems, processing centres or assembly machines.

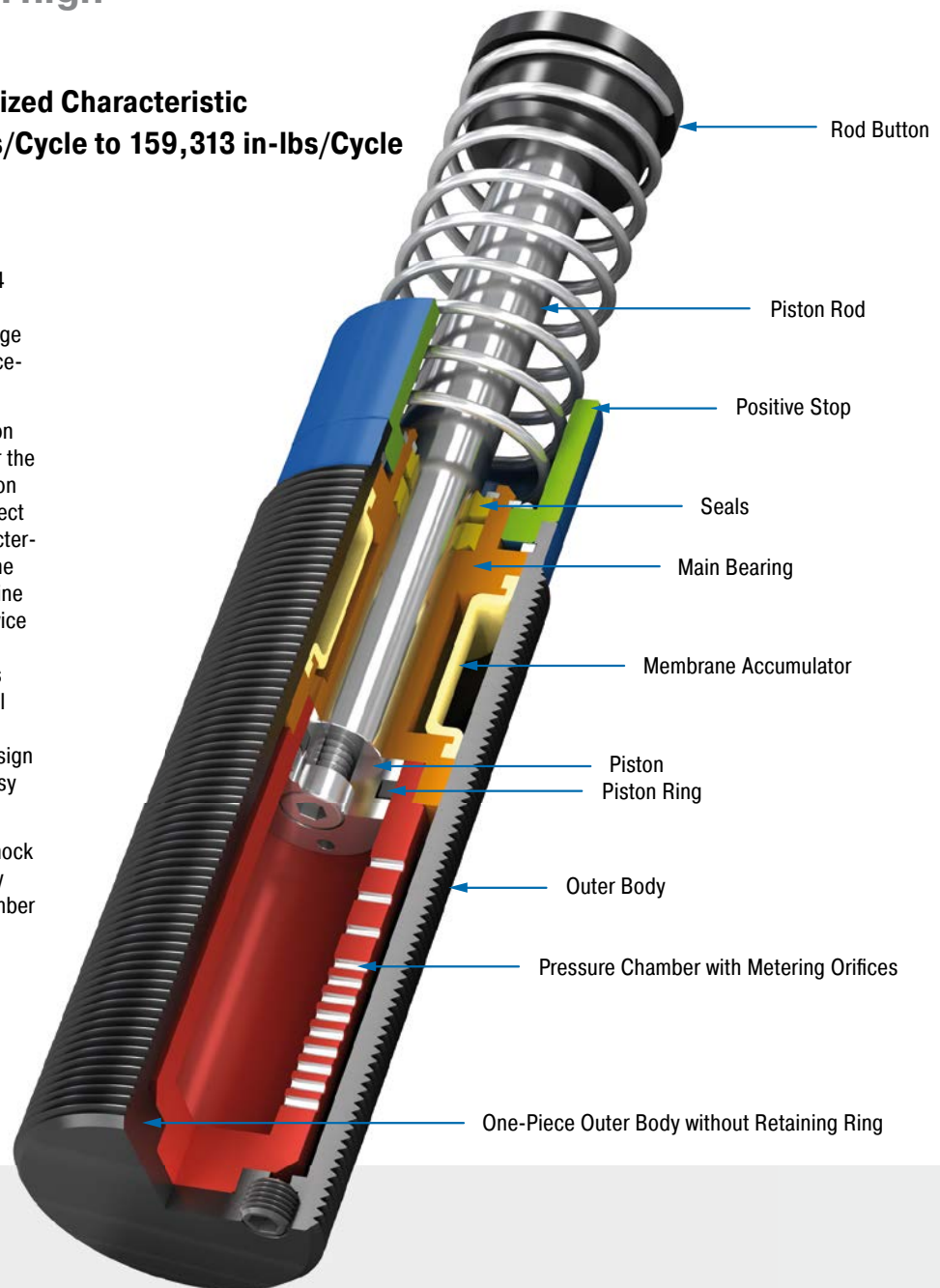

Technical Data

Energy capacity: 2,744 in-lbs/Cycle to 159,313 in-lbs/Cycle

Impact velocity range: 0.06 ft/sec to 16 ft/sec. Other speeds on request.

Operating temperature range: 10 °F to 158 °F. Other temperatures on request.

Mounting: In any position

Positive stop: Integrated

Material: Outer body: Nitride hardened steel ; Piston rod: Hard chrome plated steel ; Rod end button: Hardened steel and corrosion-resistant coating; Return spring: Zinc plated or plastic-coated steel ; Accessories: Steel corrosion-resistant coating

Damping medium: Automatic Transmission Fluid (ATF)

Application field: Finishing and processing centers, Conveyor systems, Portal systems, Test stations, Machines and plants, Swivel units, Cranes

Note: The shock absorber can be pushed through its stroke. In creep speed conditions the shock absorber provides minimal resistance and there is no braking effect.

On request: Special oils, special flanges etc.

SCS33

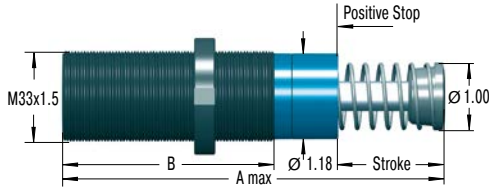

The calculation and selection of the most suitable damper should be carried out or be approved by ACE.

Accessories

250-0292 Locking Ring

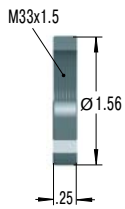

250-0293 Rectangular Flange

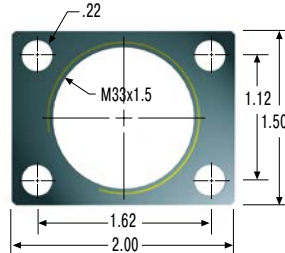

250-0294 Side-Foot Mount Assembly

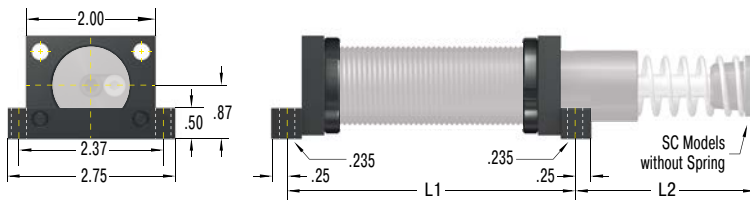

Dimensions

| TYPES | L1 inch | L2 inch |
|----------------|------------|------------|
| MC, MA, ML3325 | 3.75 | 1.94 |
| MC, MA, ML3350 | 4.75 | 2.94 |
| SC3325 | 5.31 | 1.94 |
| SC3350 | 7.31 | 2.94 |
| SCS33-25 | 3.75 | 1.94 |
| SCS33-50 | 4.75 | 2.94 |

250-0294 = 1 locknut, 2 flanges, 2 bars, 4 screws M6x40, DIN 912
Torque max.: 97 in-lbs
Clamping torque: 797 in-lbs
Bolts to mount assembled shock & mount not included.

Complete details required when ordering

- Moving load: W (lbs)
- Impact velocity range: v (ft/s) max.
- Creep speed: vs (ft/s)
- Motor power: HP (horsepower)
- Stall torque factor: ST (normal, 2.5)
- (Alternatively: Propelling force F (lbs))
- Number of absorbers in parallel: n

or technical data according to formulae and calculations on page 275.

Ordering Example

SCS33-50-1xxxx
Safety Shock Absorber _____
Thread Size M33 _____
Max. Stroke without Positive Stop 1.97" (50 mm) _____
Identification No. assigned by ACE _____

Please indicate identification no. in case of replacement order

Please contact the factory for complete part number.

Performance and Dimensions

| TYPES | Max. Energy Capacity | | Return Force min. lbs | Return Force max. lbs | Stroke inch | A max. inch | B inch | Side Load Angle max. ° | Weight lbs |
|----------|--|--|-----------------------------|-----------------------------|----------------|----------------|-----------|------------------------------|---------------|
| | E ₃ Self-compensating in-lbs/cycle | E ₃ Optimised in-lbs/cycle | | | | | | | |
| SCS33-25 | 2,744 | 4,425 | 10.1 | 20.2 | 0.91 | 5.44 | 3.27 | 3 | 1.12 |
| SCS33-50 | 5,487 | 8,408 | 10.1 | 30.3 | 1.91 | 7.44 | 4.25 | 2 | 1.39 |

¹ The values are reduced by 20 % at max. side load angle.

Self-Compensating or Optimized Characteristic

SCS45

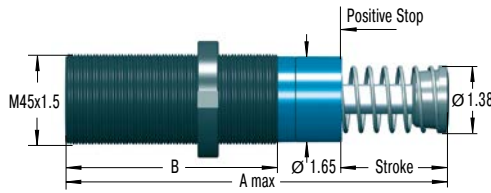

The calculation and selection of the most suitable damper should be carried out or be approved by ACE.

Accessories

250-0297 Locking Ring

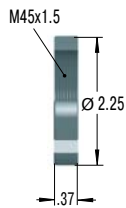

250-0298 Square Flange

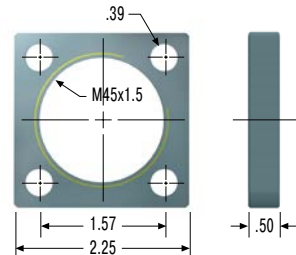

250-0299 Rectangular Flange

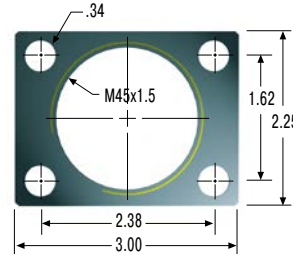

250-0300 Side-Foot Mount Assembly

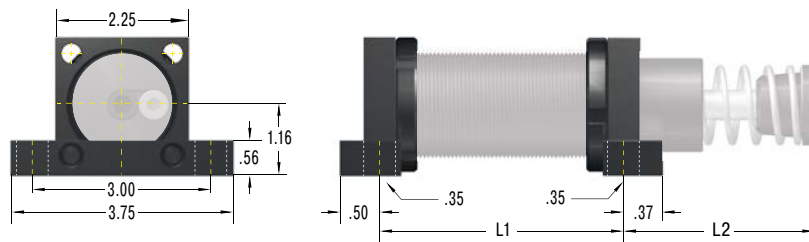

| Dimensions | | |
|----------------|------------|------------|
| TYPES | L1 inch | L2 inch |
| MC, MA, ML4525 | 3.50 | 1.94 |
| MC, MA, ML4550 | 4.38 | 3.06 |
| MC, MA4575 | 5.38 | 4.06 |
| SC4525 | 5.10 | 2.09 |
| SC4550 | 7.10 | 3.09 |
| SCS45-25 | 3.50 | 1.94 |
| SCS45-50 | 4.38 | 3.06 |
| SCS45-75 | 5.38 | 4.06 |

250-0300 = 1 locknut, 2 flanges, 2 bars, 4 screws M8x50, DIN 912
 Torque max.: 239 in-lbs
 Clamping torque: 3,098 in-lbs
 Bolts to mount assembled shock & mount not included.

Complete details required when ordering

- Moving load: W (lbs)
- Impact velocity range: v (ft/s) max.
- Creep speed: vs (ft/s)
- Motor power: HP (horsepower)
- Stall torque factor: ST (normal, 2.5)
- (Alternatively: Propelling force F (lbs))
- Number of absorbers in parallel: n

or technical data according to formulae and calculations on page 275.

Ordering Example

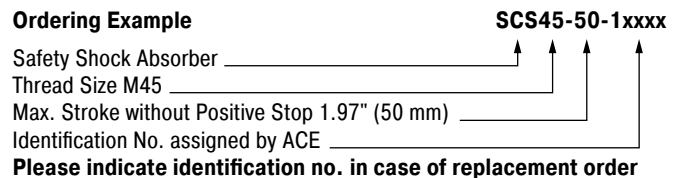

Please indicate identification no. in case of replacement order
 Please contact the factory for complete part number.

Performance and Dimensions

| TYPES | Max. Energy Capacity | | Return Force min. lbs | Return Force max. lbs | Stroke inch | A max. inch | B inch | Side Load Angle max. ° | Weight lbs |
|----------|--|--|-----------------------------|-----------------------------|----------------|----------------|-----------|------------------------------|---------------|
| | E ₃ Self-compensating in-lbs/cycle | E ₃ Optimised in-lbs/cycle | | | | | | | |
| SCS45-25 | 6,019 | 10,621 | 15.7 | 22.5 | 0.91 | 5.71 | 3.74 | 3 | 2.51 |
| SCS45-50 | 12,037 | 20,799 | 15.7 | 32.6 | 1.91 | 7.68 | 4.72 | 2 | 3.00 |
| SCS45-75 | 18,056 | 30,978 | 11.2 | 40.5 | 2.91 | 9.69 | 5.71 | 1 | 3.51 |

¹ The values are reduced by 20 % at max. side load angle.

SCS64

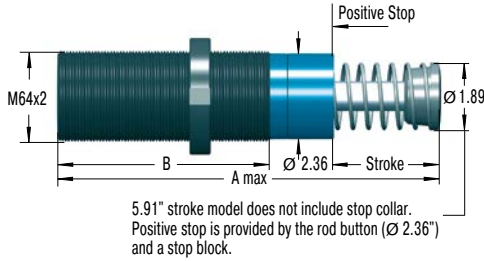

The calculation and selection of the most suitable damper should be carried out or be approved by ACE.

Accessories

250-0301 Locking Ring

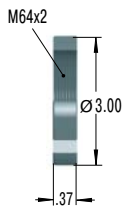

250-0302 Square Flange

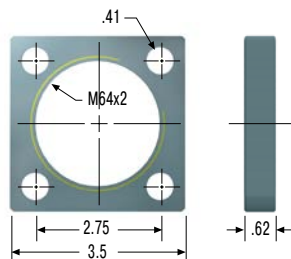

250-0304 Side-Foot Mount Assembly

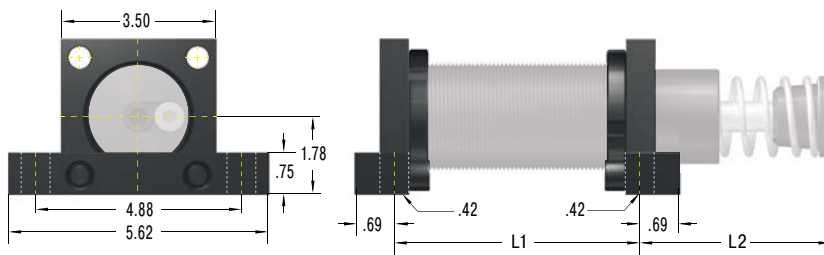

| Dimensions | | |
|----------------|------------|------------|
| TYPES | L1 inch | L2 inch |
| ML6425 | 4.00 | 2.54 |
| MC, MA, ML6450 | 5.00 | 3.54 |
| MC, MA64100 | 7.00 | 5.54 |
| MC, MA64150 | 9.00 | 8.42 |
| SCS64-50 | 5.00 | 3.54 |
| SCS64-100 | 7.00 | 5.54 |
| SCS64-150 | 9.00 | 8.42 |

250-0304 = 1 locknut, 2 flanges, 2 bars, 4 screws M10x80, DIN 912
Torque max.: 443 in-lbs
Clamping torque: 3,098 in-lbs
Bolts to mount assembled shock & mount not included.

Complete details required when ordering

- Moving load: W (lbs)
- Impact velocity range: v (ft/s) max.
- Creep speed: vs (ft/s)
- Motor power: HP (horsepower)
- Stall torque factor: ST (normal, 2.5)
- (Alternatively: Propelling force F (lbs))
- Number of absorbers in parallel: n

or technical data according to formulae and calculations on page 275.

Ordering Example

SCS64-50-1xxxx
Safety Shock Absorber _____
Thread Size M64 _____
Max. Stroke without Positive Stop 1.97" (50 mm) _____
Identification No. assigned by ACE _____

Please indicate identification no. in case of replacement order

Please contact the factory for complete part number.

Performance and Dimensions

| TYPES | Max. Energy Capacity | | Return Force min. lbs | Return Force max. lbs | Stroke inch | A max. inch | B inch | Side Load Angle max. ° | Weight lbs |
|-----------|--|--|-----------------------------|-----------------------------|----------------|----------------|-----------|------------------------------|---------------|
| | E ₃ Self-compensating in-lbs/cycle | E ₃ Optimised in-lbs/cycle | | | | | | | |
| SCS64-50 | 30,093 | 53,104 | 20.2 | 34.8 | 1.91 | 8.86 | 5.51 | 3 | 6.39 |
| SCS64-100 | 60,185 | 106,209 | 23.6 | 60.7 | 3.91 | 12.83 | 7.52 | 2 | 8.16 |
| SCS64-150 | 90,278 | 159,313 | 16.9 | 82.1 | 5.91 | 17.72 | 9.49 | 1 | 11.25 |

¹ The values are reduced by 20 % at max. side load angle.

SCS38 to SCS63

Low reaction forces with long strokes

High Rack Damper, Optimized Characteristic

Energy capacity 32,000 in-lbs/Cycle to 1,912,000 in-lbs/Cycle

Stroke 1.97 in to 47.24 in

Slim with a long stroke: safety shock absorbers from the SCS38 to SCS63 product family are designed for emergency-stop applications. Strokes of up to 47.24" (1,200 mm) are possible with these maintenance-free and ready-to-install dampers. Low reaction forces result due to the large strokes.

ACE uses our proprietary custom calculation program to design each shock absorber for the specific customer application. Customization helps reduce the risk of crashes and incorrect product sizing. The characteristic curve or damping characteristics of all safety shock absorbers from ACE are individually designed to the specific customer application. The metering orifices for the applications are specially calculated and produced. These tailor-made machine elements are the ideal protection because they are less expensive than industrial shock absorbers and are effective with up to 1,000 possible full load emergency stops.

Anyone who wants to reliably protect the end positions of rack operating equipment, conveyor and crane systems, heavy duty applications and test benches chooses these safety shock absorbers from ACE.

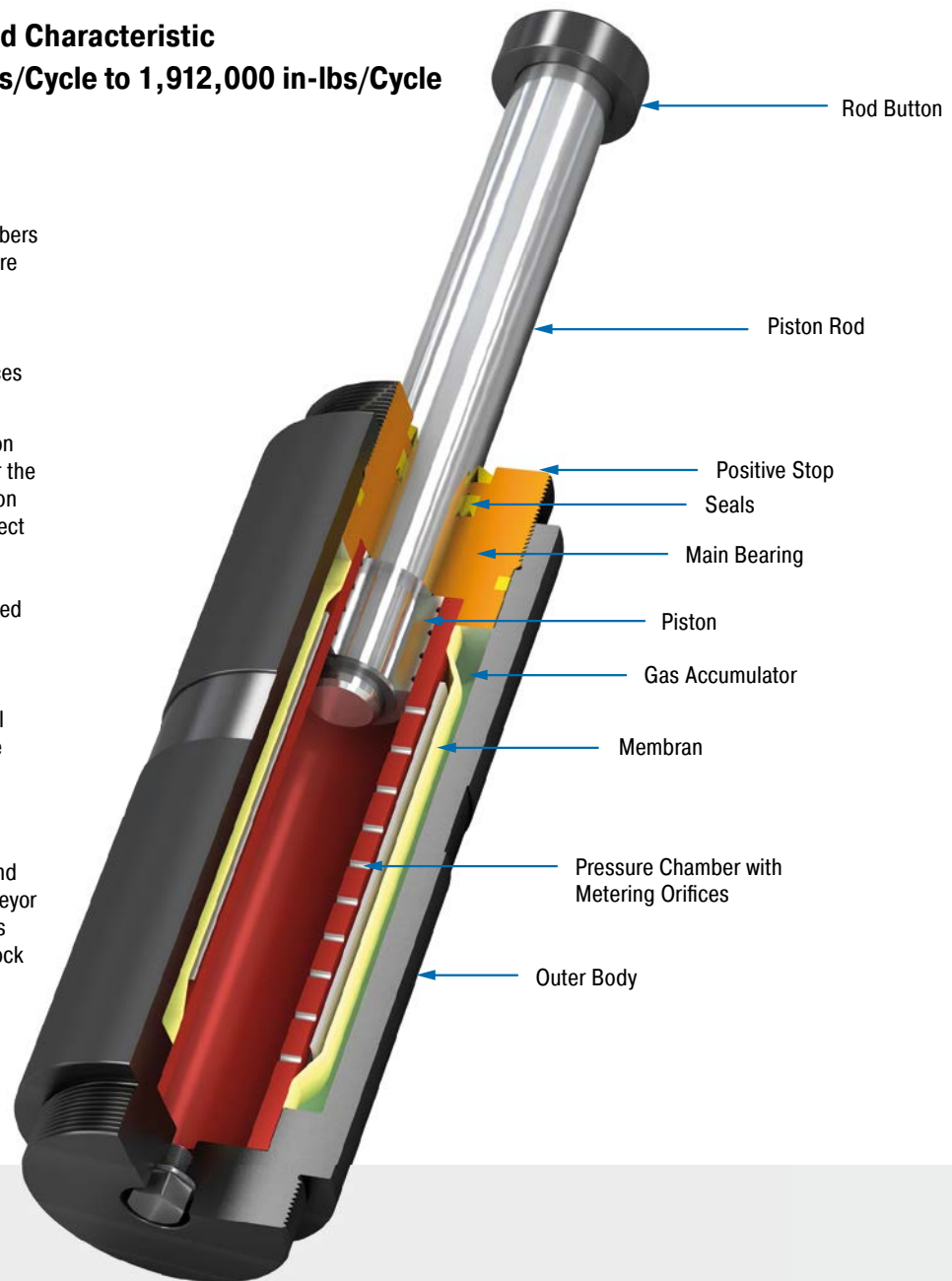

Technical Data

Energy capacity: 32,000 in-lbs/Cycle to 1,912,000 in-lbs/Cycle

Impact velocity range: 1.6 ft/sec to 15 ft/sec. Other speeds on request.

Reacting force: At max. capacity rating = 18,000 lbs to 47,200 lbs

Operating temperature range: 10 °F to 150 °F. Other temperatures on request.

Mounting: In any position

Positive stop: Integrated

Material: Outer body, Rod end button: Steel corrosion-resistant coating; Piston rod: Hard chrome plated steel

Damping medium: Automatic Transmission Fluid (ATF)

Filling pressure: Approx. 29 psi. Rod return by integrated nitrogen accumulator.

Application field: Shelf storage systems, Heavy load applications, Conveyor systems, Conveyor systems, Portal systems, Test stations

Note: The shock absorber can be pushed through its stroke. In creep speed conditions the shock absorber provides minimal resistance and there is no braking effect.

On request: Special oils, special flanges, additional corrosion protection etc. Integrated rod sensor for indicating the complete extension of the piston rod. Type normally closed or normally open, option PNP or NPN switch.

SCS38-F Front Flange

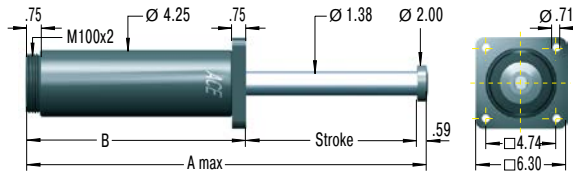

SCS38-R Rear Flange

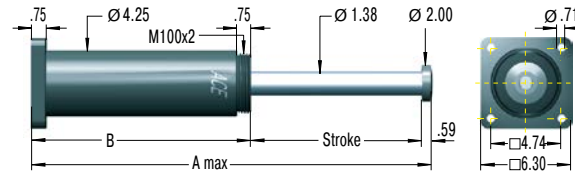

SCS38-S Foot Mount

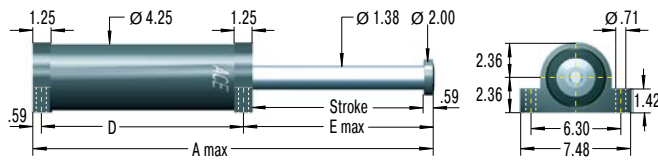

Technical Data

Impact velocity range: 3 ft/sec to 15 ft/sec

Complete details required when ordering

- Moving load: W (lbs)
- Impact velocity range: v (ft/s) max.
- Creep speed: vs (ft/s)
- Motor power: HP (horsepower)
- Stall torque factor: ST (normal, 2.5)
- (Alternatively: Propelling force F (lbs))
- Number of absorbers in parallel: n

or technical data according to formulae and calculations on page 275.

The calculation and selection of the most suitable damper should be carried out or be approved by ACE.

Ordering Example

SCS38-400-F-X
 Safety Shock Absorber _____
 Bore Size \varnothing 1.50" (38 mm) _____
 Stroke 15.75" (400 mm) _____
 Mounting Style: Front Flange _____
 Identification No. assigned by ACE _____
Please indicate identification no. in case of replacement order

Please contact the factory for complete part number.

Performance and Dimensions

| TYPES | Energy capacity in-lbs/cycle | Return Force | | Stroke inch | A max. inch | B inch | D inch | E max. inch | Mounting Style | | Mounting Style | |
|-----------|---------------------------------|--------------|-------------|----------------|----------------|-----------|-----------|----------------|---|---|--------------------------|--------------------|
| | | min. lbs | max. lbs | | | | | | ¹ F and S Side Load Angle max. ° | ¹ R Side Load Angle max. ° | F and R Weight lbs | S Weight lbs |
| SCS38-50 | 32,000 | 135 | 157 | 1.97 | 10.63 | 8.07 | 6.89 | 3.15 | 5.0 | 4.0 | 26.5 | 28.7 |
| SCS38-100 | 64,000 | 135 | 157 | 3.94 | 14.57 | 10.04 | 8.77 | 5.21 | 5.0 | 4.0 | 30.9 | 33.1 |
| SCS38-150 | 96,000 | 135 | 157 | 5.91 | 18.50 | 12.01 | 10.83 | 7.08 | 5.0 | 4.0 | 35.3 | 37.5 |
| SCS38-200 | 127,000 | 135 | 157 | 7.87 | 22.44 | 13.98 | 12.80 | 9.05 | 5.0 | 4.0 | 39.7 | 41.9 |
| SCS38-250 | 159,000 | 135 | 157 | 9.84 | 26.38 | 15.94 | 14.77 | 11.02 | 4.7 | 3.7 | 44.1 | 46.3 |
| SCS38-300 | 191,000 | 135 | 157 | 11.81 | 30.91 | 18.50 | 17.33 | 12.99 | 3.9 | 2.9 | 48.5 | 48.5 |
| SCS38-350 | 223,000 | 135 | 157 | 13.78 | 34.84 | 20.47 | 19.29 | 14.96 | 3.4 | 2.4 | 52.9 | 55.1 |
| SCS38-400 | 255,000 | 135 | 157 | 15.75 | 39.37 | 23.03 | 21.85 | 16.93 | 3.0 | 2.0 | 57.3 | 59.5 |
| SCS38-500 | 319,000 | 135 | 157 | 19.69 | 47.83 | 27.56 | 26.38 | 20.56 | 2.4 | 1.4 | 66.2 | 68.4 |
| SCS38-600 | 382,000 | 135 | 157 | 23.62 | 56.30 | 32.09 | 30.91 | 24.80 | 1.9 | 0.9 | 75.0 | 75.0 |
| SCS38-700 | 446,000 | 135 | 157 | 27.56 | 64.76 | 36.61 | 35.43 | 28.74 | 1.6 | 0.6 | 83.8 | 86.0 |
| SCS38-800 | 510,000 | 135 | 157 | 31.50 | 73.23 | 41.14 | 39.97 | 32.67 | 1.3 | 0.3 | 94.8 | 97.0 |

¹ The values are reduced by 20 % at max. side load angle.

High Rack Damper, Optimized Characteristic

SCS50-F Front Flange

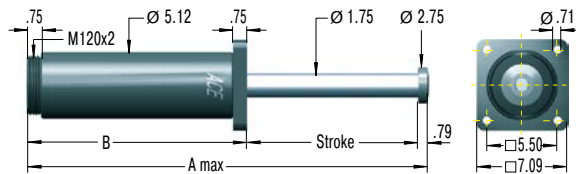

SCS50-R Rear Flange

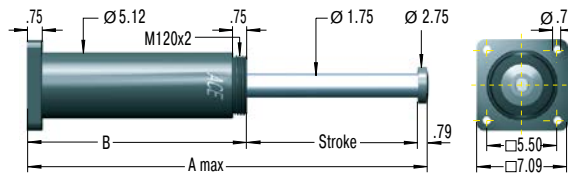

SCS50-S Foot Mount

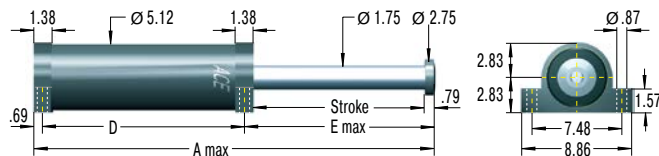

Technical Data

Impact velocity range: 2 ft/sec to 15 ft/sec

Complete details required when ordering

- Moving load: W (lbs)
- Impact velocity range: v (ft/s) max.
- Creep speed: vs (ft/s)
- Motor power: HP (horsepower)
- Stall torque factor: ST (normal, 2.5)
- (Alternatively: Propelling force F (lbs))
- Number of absorbers in parallel: n

or technical data according to formulae and calculations on page 275.

The calculation and selection of the most suitable damper should be carried out or be approved by ACE.

Ordering Example

Safety Shock Absorber _____ **SCS50-400-F-X**
 Bore Size Ø 1.97" (50 mm) _____
 Stroke 15.75" (400 mm) _____
 Mounting Style: Front Flange _____
 Identification No. assigned by ACE _____

Please indicate identification no. in case of replacement order

Please contact the factory for complete part number.

Performance and Dimensions

| TYPES | Energy capacity in-lbs/cycle | Return Force | | Stroke inch | A max. inch | B inch | D inch | E max. inch | Mounting Style | | Mounting Style | |
|------------|---------------------------------|--------------|-------------|----------------|----------------|-----------|-----------|----------------|---|---|--------------------------|--------------------|
| | | min. lbs | max. lbs | | | | | | ¹ F and S Side Load Angle max. ° | ¹ R Side Load Angle max. ° | F and R Weight lbs | S Weight lbs |
| SCS50-100 | 124,000 | 225 | 270 | 3.94 | 15.35 | 10.63 | 9.25 | 5.41 | 5.0 | 4.0 | 48.5 | 50.7 |
| SCS50-150 | 186,000 | 225 | 270 | 5.91 | 19.29 | 12.60 | 11.22 | 7.38 | 5.0 | 4.0 | 55.1 | 57.3 |
| SCS50-200 | 248,000 | 225 | 270 | 7.87 | 23.23 | 14.57 | 13.19 | 9.35 | 5.0 | 4.0 | 59.5 | 61.7 |
| SCS50-250 | 310,000 | 225 | 270 | 9.84 | 27.17 | 16.54 | 15.16 | 11.32 | 4.5 | 3.5 | 66.2 | 68.4 |
| SCS50-300 | 372,000 | 225 | 270 | 11.81 | 31.69 | 19.09 | 17.71 | 13.29 | 3.8 | 2.8 | 72.8 | 75.0 |
| SCS50-350 | 434,000 | 225 | 270 | 13.78 | 35.63 | 21.06 | 19.69 | 15.25 | 3.3 | 2.3 | 77.2 | 81.6 |
| SCS50-400 | 496,000 | 225 | 270 | 15.75 | 40.16 | 23.62 | 22.25 | 17.22 | 2.9 | 1.9 | 83.8 | 88.2 |
| SCS50-500 | 620,000 | 225 | 270 | 19.69 | 48.62 | 28.15 | 26.77 | 21.16 | 2.3 | 1.3 | 97.0 | 99.2 |
| SCS50-600 | 743,000 | 225 | 270 | 23.62 | 57.09 | 32.68 | 31.30 | 25.10 | 1.9 | 0.9 | 110.3 | 112.5 |
| SCS50-700 | 867,000 | 225 | 270 | 27.56 | 65.55 | 37.20 | 35.83 | 29.03 | 1.6 | 0.6 | 121.3 | 125.7 |
| SCS50-800 | 991,000 | 225 | 270 | 31.50 | 74.02 | 41.73 | 40.36 | 32.97 | 1.3 | 0.3 | 134.5 | 138.9 |
| SCS50-1000 | 1,239,000 | 225 | 270 | 39.37 | 90.94 | 50.79 | 49.40 | 40.85 | 1.0 | 0.0 | 158.8 | 163.2 |

¹ The values are reduced by 20 % at max. side load angle.

SCS63-F Front Flange

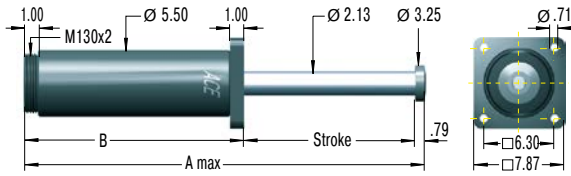

SCS63-R Rear Flange

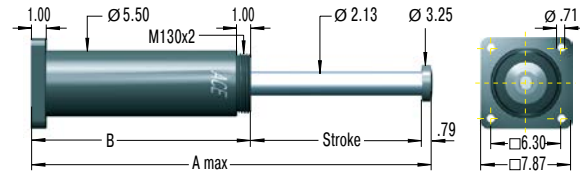

SCS63-S Foot Mount

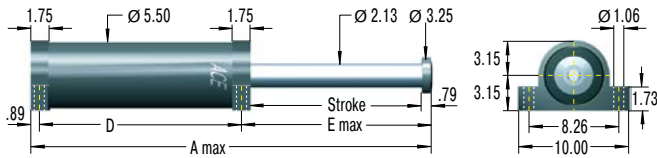

Technical Data

Impact velocity range: 1.6 ft/sec to 15 ft/sec

Complete details required when ordering

- Moving load: W (lbs)
- Impact velocity range: v (ft/s) max.
- Creep speed: vs (ft/s)
- Motor power: HP (horsepower)
- Stall torque factor: ST (normal, 2.5)
- (Alternatively: Propelling force F (lbs))
- Number of absorbers in parallel: n

or technical data according to formulae and calculations on page 275.

The calculation and selection of the most suitable damper should be carried out or be approved by ACE.

Ordering Example

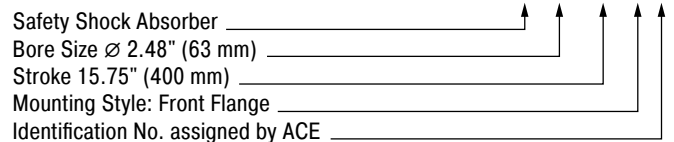

Identification No. assigned by ACE

Please indicate identification no. in case of replacement order

Please contact the factory for complete part number.

Performance and Dimensions

| TYPES | Energy capacity in-lbs/cycle | Return Force | | Stroke inch | A max. inch | B inch | D inch | E max. inch | Mounting Style | | Mounting Style | |
|------------|---------------------------------|--------------|-------------|----------------|----------------|-----------|-----------|----------------|---|---|--------------------------|--------------------|
| | | min. lbs | max. lbs | | | | | | ¹ F and S Side Load Angle max. ° | ¹ R Side Load Angle max. ° | F and R Weight lbs | S Weight lbs |
| SCS63-100 | 159,000 | 337 | 562 | 3.94 | 15.94 | 11.22 | 9.47 | 5.59 | 5.0 | 4.0 | 63.9 | 70.6 |
| SCS63-150 | 239,000 | 337 | 562 | 5.91 | 19.88 | 13.19 | 11.44 | 7.56 | 5.0 | 4.0 | 70.6 | 77.2 |
| SCS63-200 | 319,000 | 337 | 562 | 7.87 | 23.82 | 15.16 | 13.41 | 9.53 | 5.0 | 4.0 | 77.2 | 83.8 |
| SCS63-250 | 398,000 | 337 | 562 | 9.84 | 27.76 | 17.13 | 15.39 | 11.49 | 5.0 | 4.0 | 83.8 | 92.6 |
| SCS63-300 | 478,000 | 337 | 562 | 11.81 | 31.69 | 19.09 | 17.35 | 13.46 | 5.0 | 4.0 | 90.4 | 99.2 |
| SCS63-350 | 558,000 | 337 | 562 | 13.78 | 36.42 | 21.85 | 20.11 | 15.43 | 5.0 | 4.0 | 99.2 | 108.0 |
| SCS63-400 | 637,000 | 337 | 562 | 15.75 | 40.35 | 23.82 | 22.01 | 17.40 | 5.0 | 4.0 | 105.8 | 114.7 |
| SCS63-500 | 797,000 | 337 | 562 | 19.69 | 49.02 | 28.54 | 26.80 | 21.34 | 4.2 | 3.2 | 121.3 | 132.3 |
| SCS63-600 | 956,000 | 337 | 562 | 23.62 | 56.89 | 32.48 | 30.74 | 25.30 | 3.4 | 2.4 | 136.7 | 145.5 |
| SCS63-700 | 1,115,000 | 337 | 562 | 27.56 | 65.55 | 37.20 | 35.46 | 29.21 | 2.9 | 1.9 | 152.1 | 161.0 |
| SCS63-800 | 1,275,000 | 337 | 562 | 31.50 | 73.43 | 41.14 | 39.40 | 33.15 | 2.5 | 1.5 | 165.4 | 174.2 |
| SCS63-1000 | 1,593,000 | 337 | 562 | 39.37 | 89.96 | 49.80 | 48.06 | 41.02 | 1.9 | 0.9 | 196.2 | 205.1 |
| SCS63-1200 | 1,912,000 | 337 | 562 | 47.24 | 106.50 | 58.46 | 56.72 | 48.90 | 1.4 | 0.4 | 224.9 | 233.7 |

¹ The values are reduced by 20 % at max. side load angle.



CB63 to CB160

High resetting forces with gas pressure accumulator

Crane Installations, Optimized Characteristic

Energy capacity 141,600 in-lbs/Cycle to 4,248,000 in-lbs/Cycle

Stroke 3.94 in to 31.50 in

Robust powerhouse: the CB63 to CB160 product family with internal system seals are used in heavy duty areas for emergency stop. Even dirt or scratches to the piston rod do not lead to a leakage or failure. Compressed gas accumulators allow return forces of up to 22,481 lb. (100 kN) in the CB models, which can make applications in multiple bridge crane systems safer, for example. The absorber body and the robust, large-sized piston rod bearing are also designed for heavy duty operations.

ACE uses our proprietary custom calculation program to design each shock absorber for the specific customer application. Customization helps reduce the risk of crashes and incorrect product sizing. Just like all ACE safety shock absorbers, the characteristic curve or damping characteristics of each individual CB unit is individually designed to the customer application.

Whether its crane systems or machines in heavy duty applications e.g. in the metal industry or in mining, these powerful safety shock absorbers reliably protect construction designs against expensive failure.

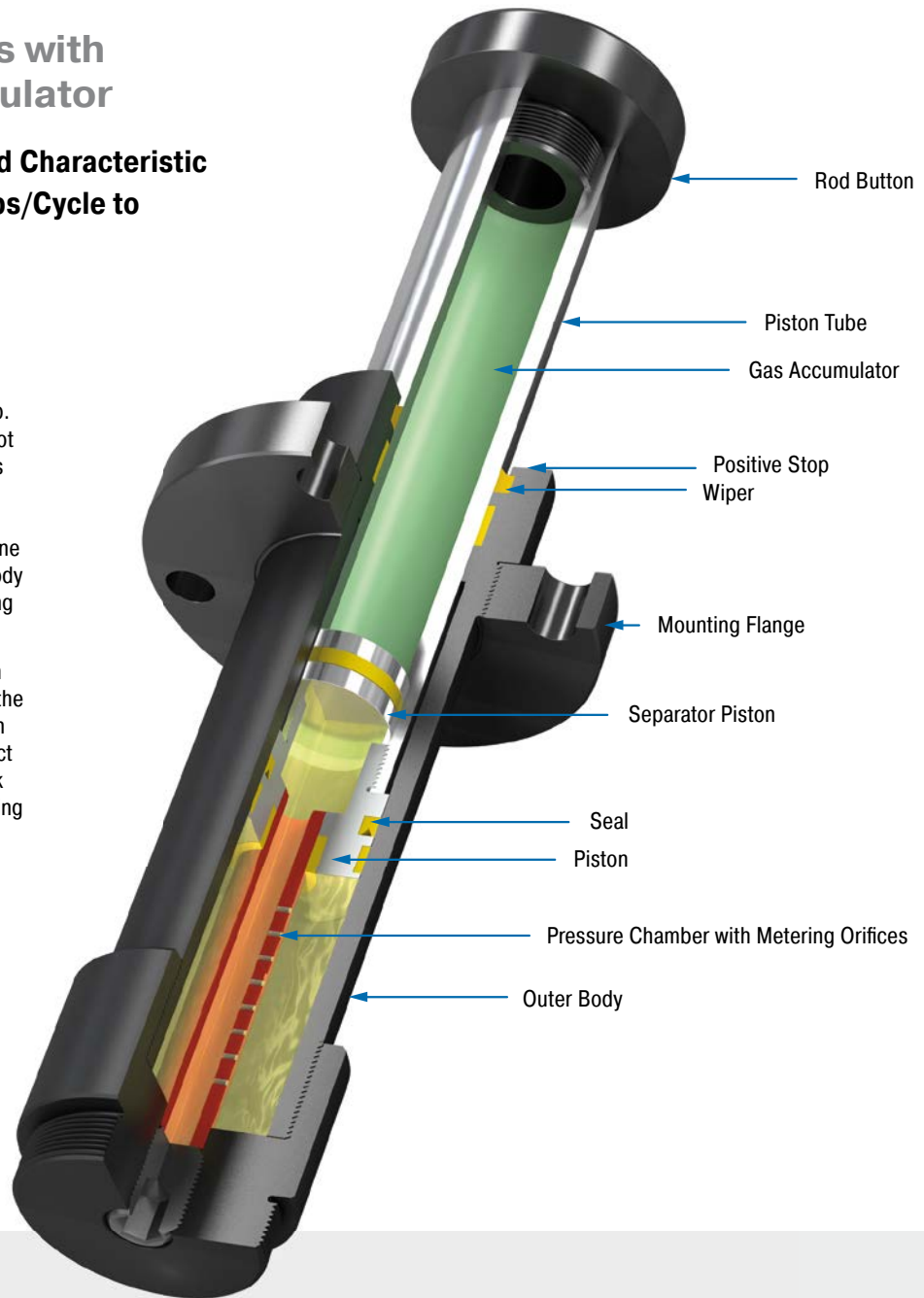

Technical Data

Energy capacity: 141,600 in-lbs/Cycle to 4,248,000 in-lbs/Cycle

Impact velocity range: 1.6 ft/sec to 15 ft/sec. Other speeds on request.

Reacting force: At max. capacity rating = 42,000 lbs to 157,000 lbs

Operating temperature range: 10 °F to 150 °F. Other temperatures on request.

Mounting: In any position

Positive stop: Integrated

Material: Outer body, Rod end button: Steel corrosion-resistant coating; Piston tube: Hard chrome plated steel

Damping medium: Automatic Transmission Fluid (ATF)

Filling pressure: Approx. 81 psi to 86 psi. Rod return by integrated nitrogen accumulator.

Application field: Heavy load applications, Heavy load applications, Conveyor systems, Portal systems

Note: The shock absorber can be pushed through its stroke. In creep speed conditions the shock absorber provides minimal resistance and there is no braking effect.

On request: Special oils, special flanges, additional corrosion protection etc.

CB63-F Front Flange

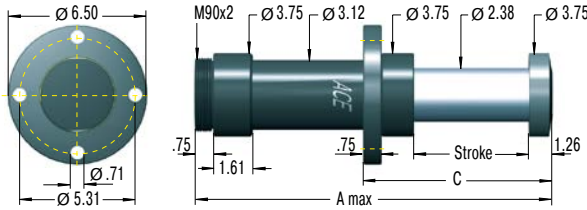

Reacting force: at max. capacity rating = **42,000 lbs max.**

CB63-R Rear Flange

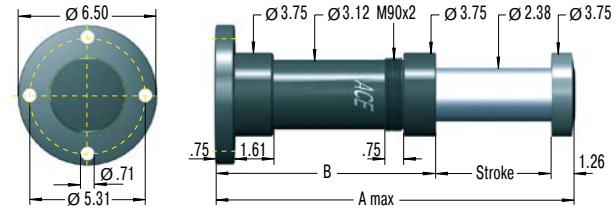

Reacting force: at max. capacity rating = **42,000 lbs max.**

CB100-F Front Flange

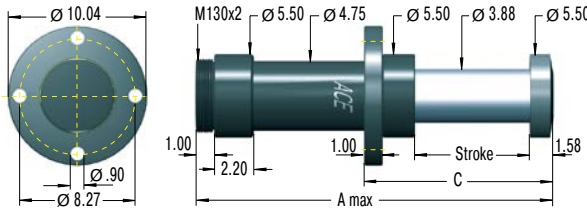

Reacting force: at max. capacity rating = **105,000 lbs max.**

CB100-R Rear Flange

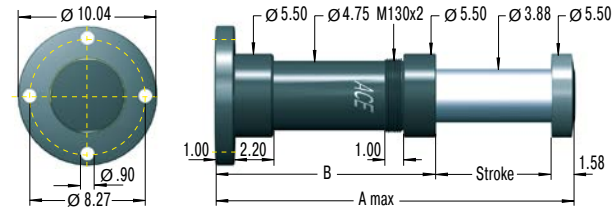

Reacting force: at max. capacity rating = **105,000 lbs max.**

CB160-F Front Flange

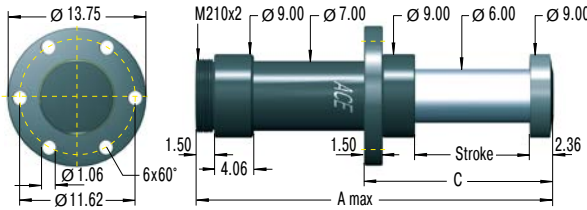

Reacting force: at max. capacity rating = **157,000 lbs max.**

CB160-R Rear Flange

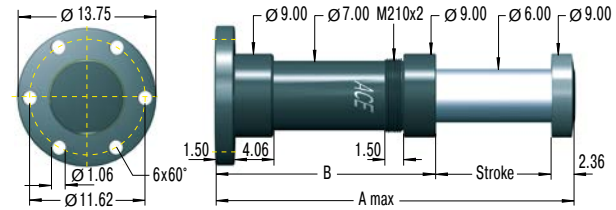

Reacting force: at max. capacity rating = **157,000 lbs max.**

Complete details required when ordering

- Moving load: W (lbs)
- Impact velocity range: v (ft/s) max.
- Creep speed: vs (ft/s)
- Motor power: HP (horsepower)
- Stall torque factor: ST (normal, 2.5)
- (Alternatively: Propelling force F (lbs))
- Number of absorbers in parallel: n

or technical data according to formulae and calculations on page 275.

The calculation and selection of the most suitable damper should be carried out or be approved by ACE.

Ordering Example

Safety Shock Absorber **CB63-400-F-X**
 Bore Size 2.48" (63 mm)
 Stroke 15.75" (400 mm)
 Mounting Style: Front Flange
 Identification No. assigned by ACE

Please indicate identification no. in case of replacement order

Please contact the factory for complete part number.

Performance and Dimensions

| TYPES | E ₃ in-lbs/cycle | Effective Weight | | Return Force min. lbs | Return Force max. lbs | Stroke inch | A max. inch | B inch | C inch | Side Load Angle max. ° | Weight lbs |
|-----------|--------------------------------|------------------|----------------|-----------------------------|-----------------------------|----------------|----------------|-----------|-----------|------------------------------|---------------|
| | | We min. lbs | We max. lbs | | | | | | | | |
| CB63-100 | 141,600 | 3,330 | 282,000 | 393 | 4,110 | 3.94 | 16.54 | 11.34 | 7.56 | 3.5 | 28.0 |
| CB63-200 | 283,200 | 6,660 | 564,000 | 393 | 5,392 | 7.87 | 27.56 | 18.43 | 11.50 | 3.0 | 36.8 |
| CB63-300 | 424,800 | 10,010 | 847,000 | 393 | 6,038 | 11.81 | 38.58 | 25.51 | 15.43 | 2.5 | 45.9 |
| CB63-400 | 566,400 | 13,340 | 1,129,000 | 393 | 6,404 | 15.75 | 49.61 | 32.60 | 19.37 | 2.0 | 54.7 |
| CB63-500 | 708,000 | 16,670 | 1,411,000 | 393 | 6,660 | 19.69 | 60.63 | 39.69 | 23.31 | 1.5 | 63.5 |
| CB100-200 | 708,000 | 16,670 | 1,411,000 | 1,005 | 9,917 | 7.87 | 28.94 | 19.49 | 12.60 | 4.0 | 93.7 |
| CB100-300 | 1,062,000 | 25,000 | 2,116,000 | 1,005 | 12,540 | 11.81 | 39.57 | 26.18 | 16.54 | 3.5 | 112.0 |
| CB100-400 | 1,416,000 | 33,330 | 2,822,000 | 1,005 | 14,459 | 15.75 | 50.20 | 32.87 | 20.47 | 3.0 | 130.3 |
| CB100-500 | 1,770,000 | 41,670 | 3,527,000 | 1,005 | 15,916 | 19.69 | 60.83 | 39.57 | 24.41 | 2.5 | 148.8 |
| CB100-600 | 2,124,000 | 50,000 | 4,233,000 | 1,005 | 17,058 | 23.62 | 71.46 | 46.26 | 28.35 | 2.0 | 167.1 |
| CB160-400 | 2,124,000 | 50,000 | 4,233,000 | 2,455 | 15,845 | 15.75 | 55.12 | 37.01 | 23.62 | 4 | 339.6 |
| CB160-600 | 3,186,000 | 75,000 | 6,349,000 | 2,455 | 15,857 | 23.62 | 78.74 | 52.76 | 31.50 | 3 | 414.5 |
| CB160-800 | 4,248,000 | 100,000 | 8,466,000 | 2,455 | 15,869 | 31.50 | 102.36 | 68.50 | 39.37 | 2 | 487.3 |

¹ The values are reduced by 20 % at max. side load angle.

EB63 to EB160

Low return force with spring assembly

Crane Installations, Optimized Characteristic

Energy capacity 141,600 in-lbs/Cycle to

4,248,000 in-lbs/Cycle

Stroke 3.94 in to 31.50 in

Reduced return forces: the ACE safety shock absorbers from the EB-Family offer internal system seals, large sized piston rod bearings and the maximum energy absorption for emergency stop applications. However, an integrated spring package in the robust shock absorber body makes sure that the return forces are reduced to a fraction of those in the CB-Family.

The damping characteristics of the maintenance-free and ready-to-install EB models is individually designed specific to the customer application, just like all ACE safety shock absorbers.

These safety shock absorbers reliably perform their services in crane systems and in numerous heavy duty applications, even if the power fails, because these hydraulic machine elements are independent braking systems.

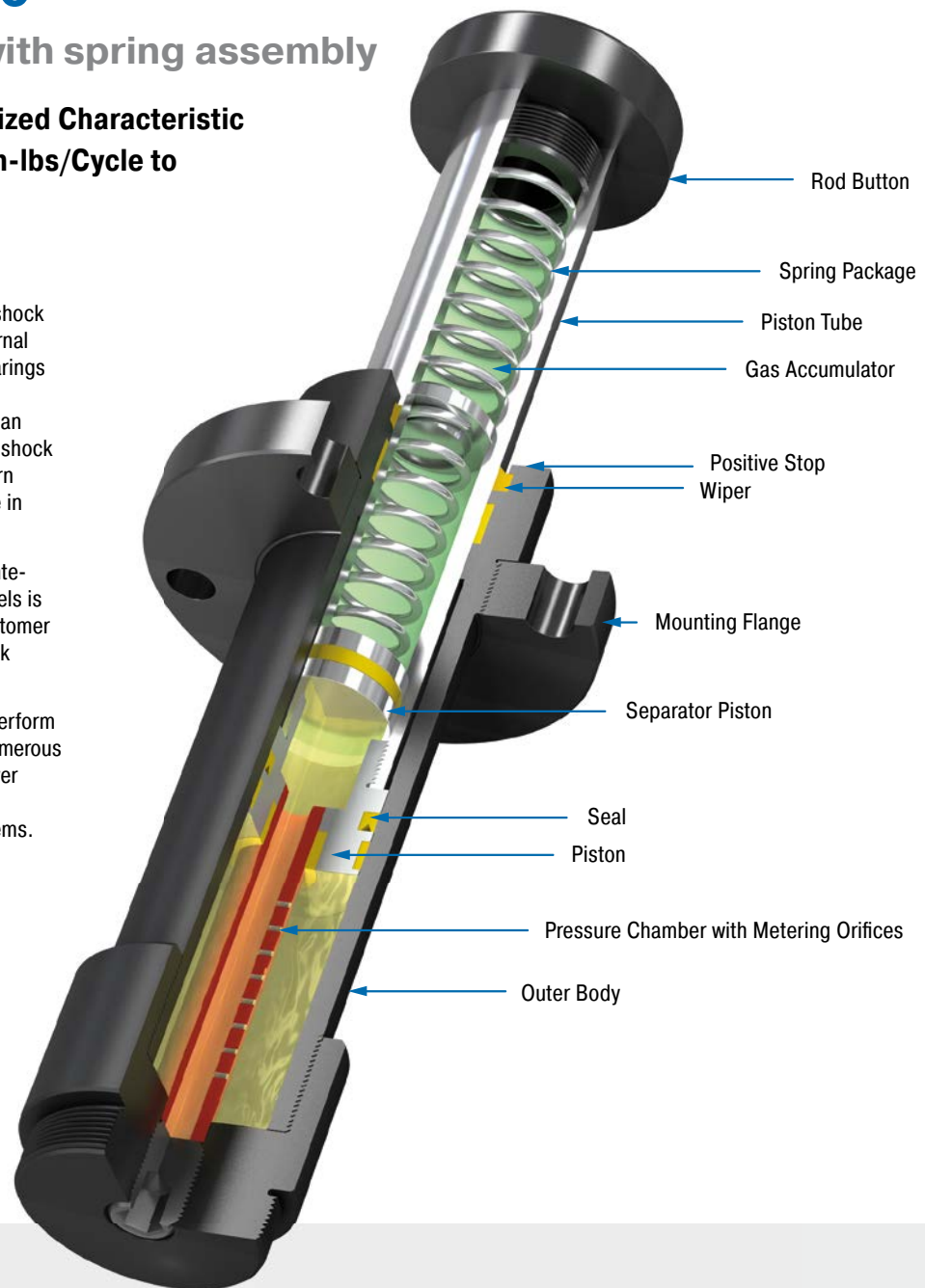

Technical Data

Energy capacity: 141,600 in-lbs/Cycle to 4,248,000 in-lbs/Cycle

Impact velocity range: 1.6 ft/sec to 15 ft/sec. Other speeds on request.

Reacting force: At max. capacity rating = 42,000 lbs to 157,000 lbs

Operating temperature range: 10 °F to 150 °F. Other temperatures on request.

Mounting: In any position

Positive stop: Integrated

Material: Outer body, Rod end button: Steel corrosion-resistant coating; Piston tube: Hard chrome plated steel

Damping medium: Automatic Transmission Fluid (ATF)

Filling pressure: Approx. 8 psi to 16 psi. Rod return by integrated nitrogen accumulator combined with additional return spring.

Application field: Heavy load applications, Heavy load applications, Conveyor systems, Portal systems

Note: The shock absorber can be pushed through its stroke. In creep speed conditions the shock absorber provides minimal resistance and there is no braking effect.

On request: Special oils, special flanges, additional corrosion protection etc.

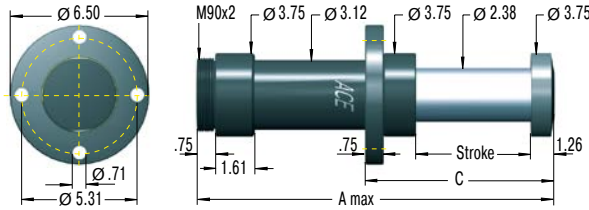
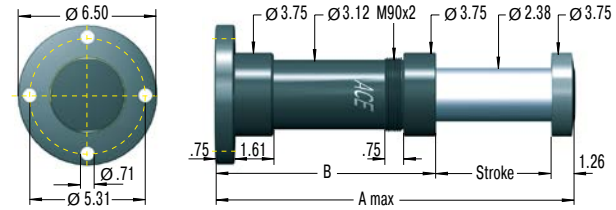
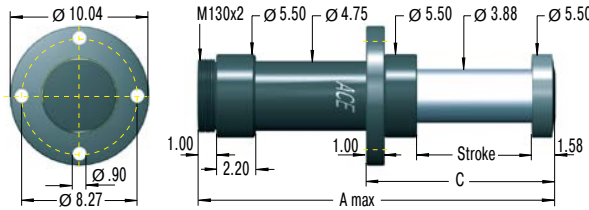
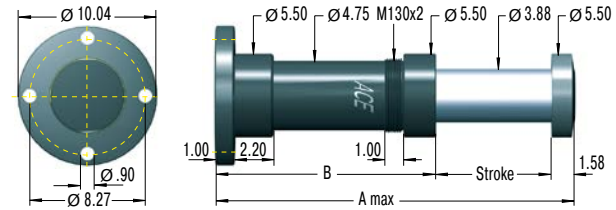
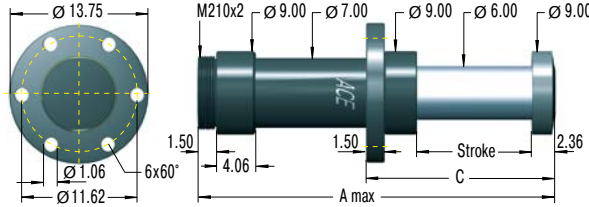
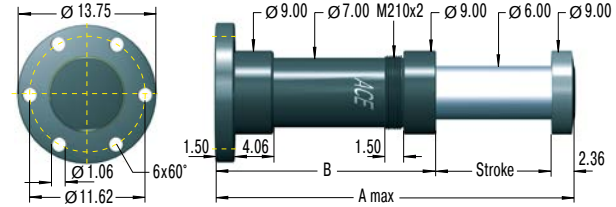
EB63-F Front Flange

Reacting force: at max. capacity rating = **42,000 lbs max.**
EB63-R Rear Flange

Reacting force: at max. capacity rating = **42,000 lbs max.**
EB100-F Front Flange

Reacting force: at max. capacity rating = **105,000 lbs max.**
EB100-R Rear Flange

Reacting force: at max. capacity rating = **105,000 lbs max.**
EB160-F Front Flange

Reacting force: at max. capacity rating = **157,000 lbs max.**
EB160-R Rear Flange

Reacting force: at max. capacity rating = **157,000 lbs max.**
Complete details required when ordering

- Moving load: W (lbs)
- Impact velocity range: v (ft/s) max.
- Creep speed: vs (ft/s)
- Motor power: HP (horsepower)
- Stall torque factor: ST (normal, 2.5)
- (Alternatively: Propelling force F (lbs))
- Number of absorbers in parallel: n

or technical data according to formulae and calculations on page 275.

The calculation and selection of the most suitable damper should be carried out or be approved by ACE.
Ordering Example

EB63-400-F-X

Safety Shock Absorber _____

Bore Size 2.48" (63 mm) _____

Stroke 15.75" (400 mm) _____

Mounting Style: Front Flange _____

Identification No. assigned by ACE _____

Please indicate identification no. in case of replacement order

Please contact the factory for complete part number.

Performance and Dimensions

| TYPES | E ₃ in-lbs/cycle | Effective Weight | | Return Force min. lbs | Return Force max. lbs | Stroke inch | A max. inch | B inch | C inch | 1 Side Load Angle max. ° | Weight lbs |
|-----------|--------------------------------|------------------|----------------|-----------------------------|-----------------------------|----------------|----------------|-----------|-----------|--------------------------------|---------------|
| | | We min. lbs | We max. lbs | | | | | | | | |
| EB63-100 | 141,600 | 3,330 | 282,000 | 157 | 1,562 | 3.94 | 16.54 | 11.34 | 7.56 | 3.5 | 30.2 |
| EB63-200 | 283,200 | 6,660 | 564,000 | 172 | 2,084 | 7.87 | 27.56 | 18.43 | 11.50 | 3.0 | 36.8 |
| EB63-300 | 424,800 | 10,010 | 847,000 | 187 | 2,372 | 11.81 | 38.58 | 25.51 | 15.43 | 2.5 | 48.1 |
| EB63-400 | 566,400 | 13,340 | 1,129,000 | 136 | 2,496 | 15.75 | 49.61 | 32.60 | 19.37 | 2.0 | 56.9 |
| EB63-500 | 708,000 | 16,670 | 1,411,000 | 151 | 2,691 | 19.69 | 60.63 | 39.69 | 23.31 | 1.5 | 65.7 |
| EB100-200 | 708,000 | 16,670 | 1,411,000 | 271 | 1,999 | 7.87 | 28.94 | 19.49 | 12.60 | 4.0 | 93.7 |
| EB100-300 | 1,062,000 | 25,000 | 2,116,000 | 213 | 3,163 | 11.81 | 39.57 | 26.18 | 16.54 | 3.5 | 112.0 |
| EB100-400 | 1,416,000 | 33,330 | 2,822,000 | 267 | 4,089 | 15.75 | 50.20 | 32.87 | 20.47 | 3.0 | 130.3 |
| EB100-500 | 1,770,000 | 41,670 | 3,527,000 | 209 | 4,686 | 19.69 | 60.83 | 39.57 | 24.41 | 2.5 | 151.0 |
| EB100-600 | 2,124,000 | 50,000 | 4,233,000 | 263 | 5,248 | 23.62 | 71.46 | 46.26 | 28.35 | 2.0 | 169.3 |
| EB160-400 | 2,124,000 | 50,000 | 4,233,000 | 421 | 4,071 | 15.75 | 55.12 | 37.01 | 23.62 | 4 | 343.1 |
| EB160-600 | 3,186,000 | 75,000 | 6,349,000 | 474 | 4,225 | 23.62 | 78.74 | 52.76 | 31.50 | 3 | 416.7 |
| EB160-800 | 4,248,000 | 100,000 | 8,466,000 | 535 | 4,380 | 31.50 | 102.36 | 68.50 | 39.37 | 2 | 490.2 |

1 The values are reduced by 20 % at max. side load angle.

Permitted Use

ACE safety shock absorbers are machine elements to brake moving masses in a defined end position in emergency stop situations for axial forces. The safety shock absorbers are not designed for regular operational usage.

Calculation of safety shock absorbers

The calculation of safety shock absorbers should generally be performed or checked by ACE.

Deceleration Properties

The orifice sizing and drill pattern in the pressure chamber are individually designed for each safety shock absorber. The respective absorption characteristic is optimized corresponding to the maximum mass that occurs in the emergency stop and the impact speed. Correspondingly, each safety shock absorber is given an individual identification number.

Model Code

For types SCS33 to 64, the individual five-digit identification numbers can be taken from the last digits of the shock absorber model code shown on the label. Example: SCS33-50-XXXXX. For type series SCS38 to SCS63, CB63 to CB160 and EB63 to EB160, the identification number is a five digit number. Example: SCS38-400-F-XXXXX. In addition to the model code, the label also shows the authorized maximum impact velocity and maximum authorised impact mass for the unit. The factory assigns these identification numbers. Please contact the factory for complete part number.

Mounting

To mount the shock absorber, we recommend the use of original ACE mounting accessories shown in catalog.

The mounting of each shock absorber must be exactly positioned so that the reaction force (Q) can be adequately transmitted into the mounting structure.

ACE recommends installation via the front flange -F mounting style that ensures the maximum protection against buckling. The damper must be mounted so that the moving loads are decelerated with the least possible side loading to the piston rod. The maximum permissible side load angles are detailed in our current catalogue.

The entire stroke length must be used for deceleration because only using part of the stroke can lead to overstressing and damage to the unit.

Mounting style front flange



Safety Shock Absorber SCS 38-66



Safety Shock Absorber CB

Environmental Requirements

The permissible **temperature range** for each shock absorber type can be found in our current catalogue.

Caution: Usage outside the specified temperature range can lead to premature breakdown and damage of the shock absorbers which can then result in severe system damage or machine failures.

Trouble free operation outdoors or in damp environments is only warranted if the dampers are coated with a specific corrosion protection finish.

Initial Start-Up Checks

First impacts on the shock absorber should only be tried after correctly mounting and with reduced impact speeds and – if possible – with reduced load. Differences between calculated and actual operating data can then be detected early on, and damage to your system can be avoided. If the shock absorbers were selected on calculated data that does not correspond to the maximum possible loading (i.e. selection based on drive power being switched off or at reduced impact speed) then these restricted impact conditions must not be exceeded during initial testing or subsequent use of the system. Otherwise you risk damaging the shock absorbers and/or your machine by overstressing materials. After the initial trial check that the piston rod fully extends again and that there are no signs of oil leakage. Also check that the mounting hardware is still securely tightened. You need to satisfy yourself that no damage has occurred to the piston rod, the body, or the mounting hardware.

Fixed Mechanical Stop

Safety shock absorbers do not need an external stop as a stroke limiter. The stroke of the safety absorber is limited by the stop of the impact head on the shock absorber. For types SCS33 to SCS64, the fixed stop point is achieved with the integrated stop collar.

What Needs to be Checked after a Full Load Impact?

Safety shock absorbers that were originally checked only at reduced speed or load need to be checked again after a full load impact (i.e. emergency use) has occurred. Check that the piston rod fully extends to its full out position, that there are no signs of oil leakage and that the mounting hardware is still securely fixed. You need to satisfy yourself that no damage has occurred to the piston rod, the body, or the mounting hardware. If no damage has occurred, the safety shock absorber can be put back into normal operation (see **initial start-up**).

Maintenance

Safety shock absorbers are sealed systems and do not need special maintenance. Safety shock absorbers that are not used regularly (i.e. that are intended for emergency stop systems) should be checked within the normal time frame for safety checks, but **at least once a year**. At this time special attention must be paid to checking that the piston rod resets to its fully extended position, that there is no oil leakage and that the mounting brackets are still secure and undamaged. The piston rod must not show any signs of damage. Safety shock absorbers that are **in use regularly** should be checked **every three months**.

Repair Notice

If any damage to the shock absorber is detected or if there are any doubts as to the proper functioning of the unit please send the unit for service to ACE. Alternatively contact your local ACE office for further advice.

[Detailed information on the above listed points can be taken from the corresponding operating and assembly instructions.](#)

Calculation Data for the Design of Safety Shock Absorbers

More formulas on pages 10 to 13

ACE shock absorbers provide linear deceleration and are therefore superior to other kinds of damping element. It is easy to calculate around 90 % of applications knowing only the following four parameters:

1. **Weight to be decelerated** **W** [lbs]
2. **Impact velocity at shock absorber** **v_D** [ft/s]
3. **Propelling force** **F** [lbs]
4. **Number of absorbers in parallel** **n**

Key to symbols used

| | | | | | |
|-----------------------------|---|-----------|-----------------------------|-----------------------------------|-------------------|
| E ₁ | Kinetic energy per cycle | in-lbs | ² v _D | Impact velocity at shock absorber | ft/s |
| E ₂ | Propelling force energy per cycle | in-lbs | F | Propelling force | lbs |
| E ₃ | Total energy per cycle (E ₁ + E ₂) | in-lbs | c | Cycles per hour | 1/hr |
| ¹ E ₄ | Total energy per hour (E ₃ · x) | in-lbs/hr | s | Shock absorber stroke | in |
| We | Effective weight | lbs | Q | Reaction force | lbs |
| W | Weight to be decelerated | lbs | t | Deceleration time | s |
| n | Number of shock absorbers (in parallel) | | a | Deceleration | ft/s ² |
| ² v | Velocity at impact | ft/s | | | |

¹ All mentioned values of E₄ in the capacity charts are only valid for room temperature. There are reduced values at higher temperature ranges.

² v or v_D is the final impact velocity of the mass. With accelerating motion the final impact velocity can be 1.5 to 2 times higher than the average. Please take this into account when calculating kinetic energy.

In all the following examples the choice of shock absorbers made from the capacity chart is based upon the values of (E₃), (E₄), (We) and the desired shock absorber stroke(s).

Note: When using several shock absorbers in parallel, the values (E₃), (E₄) and (We) are divided according to the number of units used.

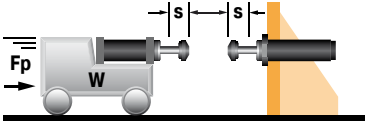
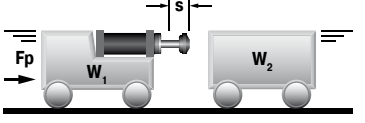
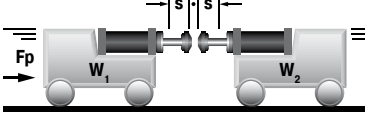
| Application | Formula | Example |
|--|--|--|
| 19 Wagon against 2 shock absorbers  | $E_1 = 0.093 \cdot W \cdot v^2$ $E_2 = F \cdot s$ $E_3 = E_1 + E_2$ $v_D = v \cdot 0.5$ $We = E_3 / (0.186 \cdot v_D^2)$ | <p>W = 2000 lbs F = 500 lbs v = 5 ft/s s = 1.91 in (chosen)</p> <p>E₁ = 0.093 · 2000 · 5² = 4650 in-lb E₂ = 500 · 1.91 = 955 in-lb E₃ = 4650 + 955 = 5605 in-lb E₄ = 5605 · 20 = 112100 in-lb/hr v_D = 5 · 0.5 = 2.5 ft/s We = 5605 / (0.186 · 2.5²) = 4194 lbs</p> <p>Chosen from capacity chart: Model SCS45-50 self-compensating</p> |
| 20 Wagon against wagon  | $E_1 = \frac{0.186 (W_1 \cdot W_2)}{(W_1 + W_2) \cdot (v_1 + v_2)^2}$ $E_2 = F \cdot s$ $E_3 = E_1 + E_2$ $E_4 = E_3 \cdot c$ $v_D = (v_1 + v_2) / 2$ $We = E_3 / (0.186 \cdot v_D^2)$ | <p>W = 4000 lbs v₁ = 2 ft/s c = 30 /hr W₂ = 8000 lbs v₂ = 1.2 ft/s F = 1000 lbs s = 1.91 in (chosen)</p> <p>E₁ = 0.186 (4000 · 8000) / (4000 + 8000) · (2 + 1.2)² = 5079 in-lb E₂ = 1000 · 2.91 = 2910 in-lb E₃ = 5079 + 2910 = 7989 in-lb v_D = (2 + 1.2) / 2 = 1.6 ft/s We = 7989 / (0.186 · 3.2²) = 4194 lbs</p> <p>Chosen from capacity chart: Model SCS45-75 self-compensating</p> |
| 21 Wagon against wagon 2 shock absorbers  | $E_1 = \frac{0.093 (W_1 \cdot W_2)}{(W_1 + W_2) \cdot (v_1 + v_2)^2}$ $E_2 = F \cdot s$ $E_3 = E_1 + E_2$ $E_4 = E_3 \cdot c$ $v = (v_1 + v_2) / 2$ $We = E_3 / (0.186 \cdot v_D^2)$ | <p>W = 4000 lbs v₁ = 2 ft/s c = 30 /hr W₂ = 8000 lbs v₂ = 1.2 ft/s F = 1000 lbs s = 1.91 in (chosen)</p> <p>E₁ = 0.093 (4000 · 8000) / (4000 + 8000) · (2 + 1.2)² = 2540 in-lb E₂ = 1000 · 1.91 = 1910 in-lb E₃ = 2540 + 1910 = 4450 in-lb v_D = (2 + 1.2) / 2 = 1.6 ft/s We = 4450 / (0.186 · 1.6²) = 9346 lbs</p> <p>Chosen from capacity chart: Model SCS45-50 self-compensating</p> |

Application Examples

SCS45

Controlled emergency stop

ACE safety shock absorbers protect precision assembly jigs for the aircraft industry. The basic mount of this coordinate measuring machine for the production of parts in the aircraft industry is made of granite and must not be damaged. To avoid damage from operating errors or mishandling, all movement axes were equipped with safety shock absorbers of the type SCS45-50. If the turntables malfunction the safety shock absorbers decelerate the loads before expensive damage can occur to the granite measuring tables.



Optimally protected turntable

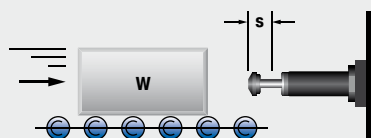

SCS33, SCS45

High-level protection of linear modules

Safety shock absorbers produced by ACE are installed in the top linear system models of one of the most prestigious companies in the field of drive and control technology. Their job: to protect the z-axis from damage caused by uncontrolled movements. Various safety dampers are used for different load ranges. Tests have shown that, in the worst case, a collision speed of up to 16.5 f/s might occur. To be on the safe side, the interpretations were based in all cases on a slightly higher value.

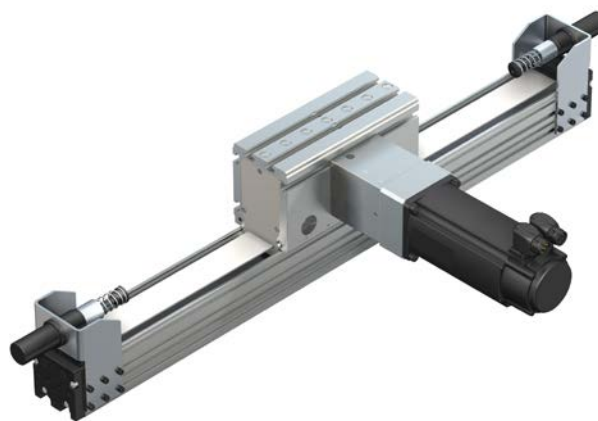

For protecting equipment and modules such as these, the SCS series from ACE is the ideal solution in the emergency stop sector
Roth GmbH & Co. KG, 90411 Nürnberg, Germany and
Bosch Rexroth AG, 97816 Lohr am Main, Germany

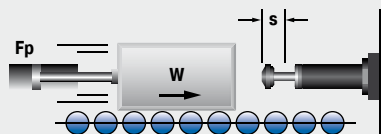

SCS38

Safe driving in end positions with ACE

The aim was to protect a driving simulation capsule on two of its eight axes. The demands placed on a potential emergency stopper were high because it was clear that its failure would lead to massive damage to the complete construction as well as to the capsule. Even the possibility of damage to the health of the test personnel could not be ruled out and was taken into consideration in a diverse range of mass-speed combinations. Two ACE safety shock absorbers now safely contain destructive forces, e.g. during power outages, and eliminate high risks.



ACE safety shock absorbers protect end positions in two axes of a driving simulator

Bosch Rexroth BV, Boxtel 5281 RV, The Netherlands and
University of Stuttgart - FKFS, 70569 Stuttgart, Germany

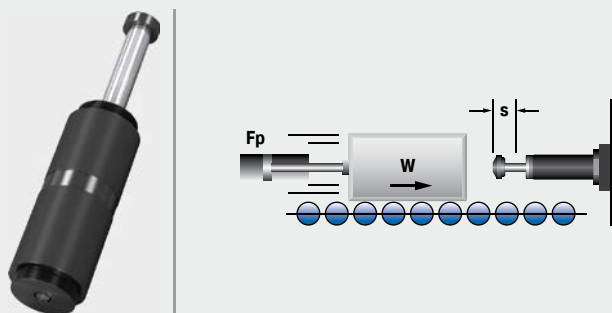

Safety Bumpers

Top for emergency stopping

The extremely successful TUBUS series from ACE is suitable for emergency stopping, as overrun protection or as end stop dampers. Available in different variations for heavy duty or crane installations, these profile dampers are perfect when loads do not need to be instantly decelerated or when working under extreme conditions.

Made of co-polyester elastomer, the highly resistant absorbers provide high force and energy absorption in areas where other materials fail or where a similarly high service life of up to 1 million load cycles cannot be achieved. They are cost-effective and distinguished by the small, light design. With energy absorption within a range of 3,983 and 157,632 in-lbs, they can be considered as an alternative to hydraulic end position damping.



Safety Bumpers



TUBUS TC and TC-S

Crane Installations

Compact powerhouse

Crane systems, Loading and lifting equipment, Hydraulic devices,
Electro-mechanical drives

Page 280

Extremely durable

Highly resistant co-polyester elastomers

Lightweight designs

Cost-effective use

Heavy-duty versions available



TUBUS TC and TC-S

Compact powerhouse

Crane Installations

Energy capacity 5,576 in-lbs/Cycle to 157,632 in-lbs/Cycle

Maximum stroke 1.18 in to 7.80 in

For even more protection: the profile dampers from the TC range of the ACE TUBUS-Series can also be used as safety dampers. These maintenance-free, ready-to-install damping elements made of co-polyester elastomer have been specially developed for use in crane systems and meet the international industry standards for OSHA and CMAA. The TC-S design employs a unique dual concept to achieve the spring rate required for crane systems.

Whether TC-S or TC, this range of models represents a cost-effective solution with high energy absorption for energy management systems. The very small and light design of Ø 2.52" to Ø 6.93" (Ø 64 mm to Ø 176 mm) progressively covers energy absorption within a range of 3,983 in-lbs to 157,632 in-lbs (450 Nm to 17,810 Nm).

The profile dampers from the TC range protect cranes, loading and lifting equipment, hydraulic units and much more.

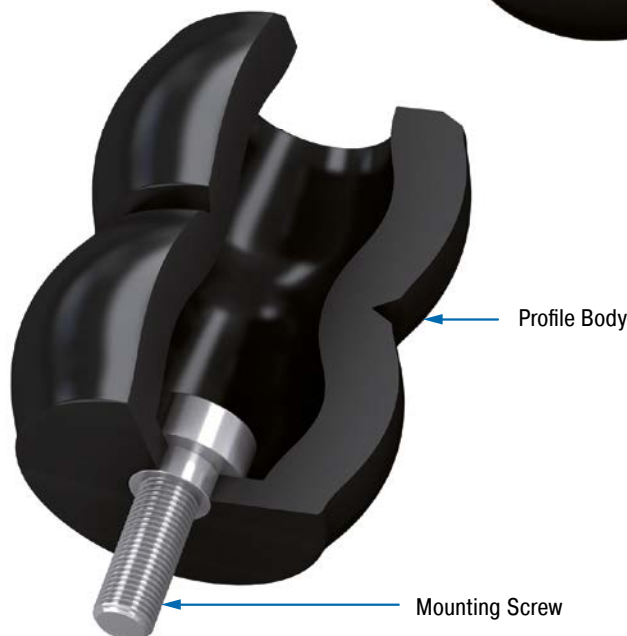

Technical Data

Energy capacity: 5,576 in-lbs/Cycle to 157,632 in-lbs/Cycle

Energy absorption: 31 % to 64 %

Dynamic force range: 17,985 lbs to 219,864 lbs

Operating temperature range: -40 °F to 120 °F

Construction size: 2.52 in to 6.93 in

Material hardness rating: Shore 55D

Material: Profile body: Co-Polyester Elastomer

Mounting: In any position

Environment: Resistant to microbes, seawater or chemical attack. Excellent UV and ozone resistance. Material does not absorb water or swell.

Impact velocity range: Max. 16.4 ft/sec

Torque max.:

M12: 36.88 ft-lbs

M16: 29.50 ft-lbs (DIN912)

M16: 88.51 ft-lbs (shouldered screw)

Application field: Crane systems, Loading and lifting equipment, Hydraulic devices, Electro-mechanical drives

Note: Suitable for emergency stop applications and for continuous use. For applications with preloading and increased temperatures please consult ACE.

On request: Special strokes, -characteristics, -spring rates, -sizes and -materials.

TC

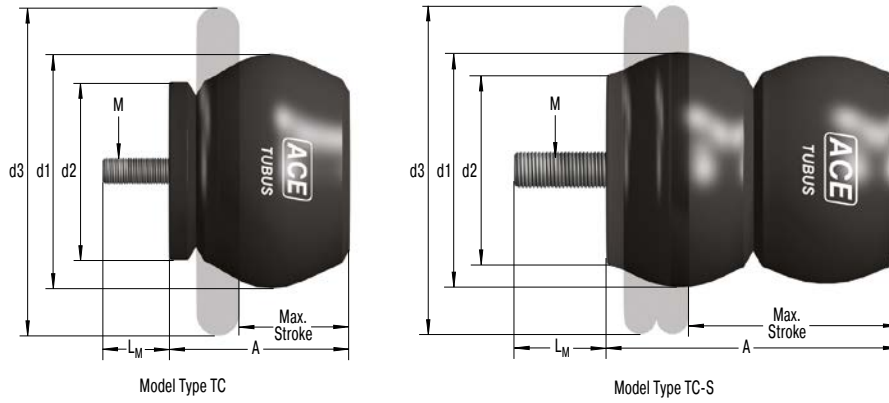

Characteristics

Type TC90-49
Energy-Stroke Characteristic (dynamic)
(with impact velocity over 1.64 ft/s)

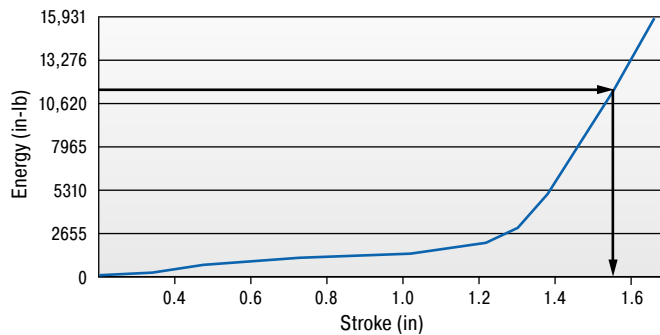

Type TC90-49
Force-Stroke Characteristic (dynamic)
(with impact velocity over 1.64 ft/s)

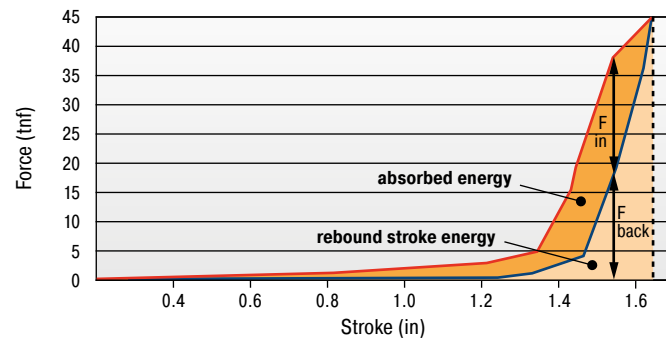

With the aid of the characteristic curves above you can estimate the proportion of the total energy that will be absorbed.

Example: With impact energy of 11,506 lbs the Energy-Stroke diagram shows that a stroke of 1.50 in is needed.

On the Force-Stroke diagram you can estimate the proportion of absorbed energy to rebound energy at this stroke length.

Note: With these types the return force towards the end of the stroke is significant and we recommend you try to use a minimum of 90 % of the total stroke available.

Dynamic ($v > 1.64$ ft/s) and static ($v \leq 1.64$ ft/s) characteristics of all types are available on request.

The calculation and selection of the most suitable damper should be carried out or be approved by ACE.

Ordering Example

TUBUS Crane Buffer _____ **TC83-73-S**
 Outer- \varnothing 3.27" (83 mm) _____
 Stroke 2.87" (73 mm) _____
 Model Type Soft _____

Performance and Dimensions

| TYPES | Emergency Stop | | Stroke max. inch | A inch | d1 inch | d2 inch | d3 inch | L _M inch | M | Weight lbs |
|-------------|---|--------------------------------|---------------------|-----------|------------|------------|------------|------------------------|-----|---------------|
| | ¹ E ₃ in-lbs/cycle | E ₃ in-lbs/cycle | | | | | | | | |
| TC64-62-S | 3,983 | 5,576 | 2.44 | 3.11 | 2.52 | 2.05 | 3.50 | 0.47 | M12 | 0.385 |
| TC74-76-S | 8,674 | 12,143 | 2.99 | 3.78 | 2.91 | 2.40 | 4.49 | 0.47 | M12 | 0.574 |
| TC83-73-S | 17,170 | 24,030 | 2.87 | 3.70 | 3.27 | 2.72 | 5.00 | 0.47 | M12 | 0.722 |
| TC86-39 | 10,709 | 15,002 | 1.54 | 2.20 | 3.39 | 3.07 | 5.24 | 0.47 | M12 | 0.626 |
| TC90-49 | 14,515 | 20,312 | 1.93 | 2.68 | 3.54 | 2.64 | 4.88 | 0.47 | M12 | 0.583 |
| TC100-59 | 15,799 | 22,127 | 2.32 | 3.31 | 3.94 | 3.58 | 5.87 | 0.47 | M12 | 1.196 |
| TC102-63 | 17,436 | 24,428 | 2.48 | 3.86 | 4.02 | 3.23 | 5.51 | 0.87 | M16 | 1.459 |
| TC108-30 | 16,816 | 23,543 | 1.18 | 2.09 | 4.25 | 3.03 | 5.24 | 0.47 | M12 | 0.863 |
| TC117-97 | 32,836 | 45,980 | 3.82 | 5.08 | 4.61 | 3.94 | 7.40 | 0.63 | M16 | 2.299 |
| TC134-146-S | 64,699 | 90,543 | 5.75 | 7.40 | 5.28 | 4.61 | 8.46 | 1.18 | M16 | 3.737 |
| TC136-65 | 37,616 | 52,662 | 2.56 | 4.17 | 5.35 | 4.17 | 7.01 | 0.63 | M16 | 2.529 |
| TC137-90 | 56,202 | 78,683 | 3.54 | 4.53 | 5.39 | 4.45 | 8.50 | 0.83 | M16 | 2.647 |
| TC146-67-S | 73,727 | 103,200 | 2.64 | 4.65 | 5.75 | 3.90 | 7.52 | 0.63 | M16 | 3.468 |
| TC150-178-S | 78,418 | 109,749 | 7.01 | 9.49 | 5.91 | 5.20 | 8.82 | 0.63 | M16 | 5.896 |
| TC153-178-S | 64,256 | 89,968 | 7.01 | 8.90 | 6.02 | 5.16 | 9.49 | 0.63 | M16 | 5.560 |
| TC168-124 | 89,392 | 125,149 | 4.88 | 6.54 | 6.61 | 5.79 | 10.24 | 0.63 | M16 | 5.585 |
| TC176-198-S | 112,626 | 157,632 | 7.80 | 9.92 | 6.93 | 5.91 | 10.98 | 0.63 | M16 | 8.070 |

¹ Max. energy capacity per cycle for continuous use.

Clamping Elements

On-the-spot clamping and stopping in emergencies and other situations

Clamping elements from the LOCKED series provide a high level of safety. These ACE products clamp and decelerate loads and are suitable for perfectly controlled holding, both linear and rotary, in all processes.

Alongside ACE LOCKED solutions for conventional rail, rod or rotation clamping, special clamps with safety function for Z-axes, which reliably help secure axes with a gravitational load, are available in the LOCKED LZ-P series. The latter solution is available for both pneumatic operation and as an electric version. Whether Z-axes, linear guide, rod or rotation clamping, the choice is (typical of ACE) as large as the performance capacity of the products, which are compatible with the solutions of all standard manufacturers.



LOCKED by ACE. After all, safe is safe.

Increased process reliability

Available as clamping and emergency stop brakes

Very short stop distances

Very high clamping forces

Compact designs

Ideal for all standard sizes



Rail Clamping

For safe deceleration of rail-guided construction elements

Safe deceleration of a mass that is traversed with the help of a rail and guide rail and track carriage combination must be complied with and not only for safety reasons; reliable clamps in the production processes are also becoming increasingly important.

Both features can be taken care of by the clamping elements from ACE. All clamping elements work with the patented spring steel plate system.

This system achieves braking and clamping forces of up to 2,248 lbs. The clamping elements are always individually adapted to the used linear guide. They are available for all rail sizes and profiles for all renowned manufacturers.

Function of clamping elements LOCKED PL/SL/PLK/SLK

All process and safety clamps work with the reinforced spring steel plate system.

Compressed air is introduced between the two spring plates, which are connected with a surrounding rubber coating.

If pressure is applied, the clamping element can freely move; if the clamping element is vented clamping to the guide rail follows.

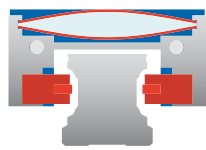

Clamping element ventilated

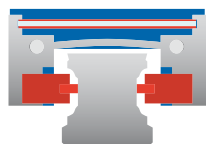

Clamping element vented

Released

The chamber filled with compressed air between the spring steel plates relaxes and thus releases the clamping/brake pads from the rail. The clamping element is now free to move.

Engaged

The clamping force of the mechanically pre-stressed spring steel plates is transferred to the clamping/brake pads as holding force. The clamping element is clamped on the guide rail.

Slot dimensions between braking and clamping linings and linear guide rail

The internal dimension "I" between the linings of every LOCKED rail clamping is ground to an exact value.

This is always 0.0004 to 0.0012 inch greater than the upper limit J max. of the respective linear guide rail (see drawing), resulting from the manufacturer's directives.

The maximum holding force results at J max. and, in the most unfavorable case, holding force losses up to 30 % can occur (see table).

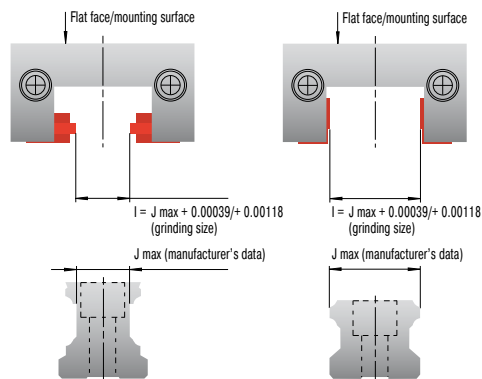

| Air Gap Lining/Linear Guide Rail inch | Loss in Holding Force % |
|---|-------------------------------|
| 0.0004 | 5 |
| 0.0012 | 10 |
| 0.0020 | 20 |
| 0.0028 | 30 |

Different brake pads for PL/PLK and for SL/SLK

The process clamps and safety clamps are available completely identical in their structure.

They differ only in the clamping and brake pads material.



Clamping



Braking

Position Clamping

The types of the LOCKED series PL and PLK are designed for clamping directly on the linear guide. The clamping linings are produced from tool steel and offer 100 % clamping force, even in the case of lubricated rails.

Position Clamping and Emergency Stop Braking

With the typical SL, SLK, low-wear sinter graphite linings are employed. These enable both a position clamping, as well as emergency stop braking on the linear guide. In case of lubricated rails, a stopping force of 60 % of the nominal stopping force should be considered.

Rod Clamping

The modular solution for exact holding at certain positions

Safe and reliable stopping at a position or an operating state is an important part of many production processes. This task can be performed by the clamping elements from ACE. If clamping on a rod is required, the clamping elements of the PN and PRK families are the right choice.

Thanks to the patented spring steel plate system the rod clamps transfer clamping forces of up to 6,070 lbs directly to the (piston) rod.

The PN and PRK rod clamps can absorb both axial and rotary forces.

Function of clamping elements LOCKED PN and PRK

Consisting of a deck plate, one to four clamping units and a base plate, all rod clamps work with the reinforced spring steel plate system.

Through that, both axial and rotary forces can be absorbed.

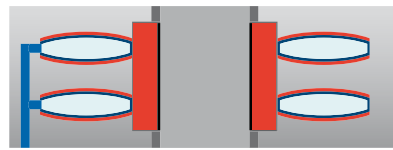

Clamping element is released

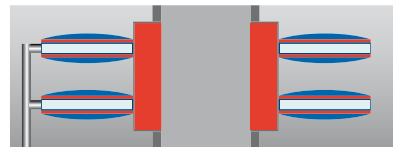

Clamping element is engaged

Released

The membrane filled with compressed air relaxes the spring steel plate system and releases the clamping sleeve.

Engaged

The clamping force of the mechanically pre-stressed spring steel plates system is transferred as a holding force into the clamping sleeve. The rod or shaft is engaged.

Intelligent component system solution

By connecting up to four clamping units between the base and deck plates, it is possible to easily increase the clamping force.



Modular construction

Component tolerances for LOCKED PN and PRK

Design-related, the addition of the individual component tolerances leads to an elastic axial tolerance allowance. This axial tolerance allowance can be up to 500 µm in the clamped status, according to implementation!

The axis/shaft/rod must be machined with at least h9-fit (or better) above h5. Deviations from the prescribed tolerance can lead to reduction of the stopping force, or functional failure.



Rod clamping

Rotational Clamping

The reliable protection against twisting

Reliable holding and securing against a rotation of a position are important elements in many production processes.

This task can be performed by means of the clamping elements of the Locked R family. The rotational clamps can, thanks to the patented spring steel plate system, transfer holding torques of up to 41,421 lbs to the shaft.

The spring accumulator can immediately clamp the axis during a power failure.

Function of clamping elements LOCKED R

The reinforced spring steel plate system transfers holding torques in the shortest possible time.



Clamping element is released

Released

The membrane filled with compressed air relaxes the spring steel plate system and releases the clamping ring. The shaft is free to move.



Clamping element is engaged

Engaged

The clamping force of the membrane/spring steel plates systems is transferred to the holding force of the clamping ring. The shaft is clamped.

Function of clamping elements LOCKED R-Z with additional air

If higher holding torques are required, the rotational clamps with an additional air function are used.

With the same size, significantly higher holding torques are achieved.



Increased clamping force with additional air

Engaged with additional air

By filling the outer membrane chamber with additional compressed air (58 or 87 psi), there is the possibility to increase the clamping force. The clamping element is engaged in this condition.

Clamping Elements



LOCKED PL

Process Clamping for Rail Systems

High clamping power for all rail profiles

Tool machines, Transport systems, Feeder installations,
Positioning tables



LOCKED PLK

Process Clamping for Rail Systems, Compact

High clamping power for all compact design rail profiles

Tool machines, Transport systems, Feeder installations,
Positioning tables



LOCKED SL

Safety Clamping for Rail Systems

Combined clamping and braking

Tool machines, Transport systems, Feeder installations,
Positioning tables



LOCKED SLK

Safety Clamping for Rail Systems, Compact

Combined compact design clamping and braking

Tool machines, Transport systems, Feeder installations,
Positioning tables



LOCKED LZ-P

Rail Clamping for Z-Axes

Certified safety clamping

Z-axes, Vertical conveyor systems, Jacking applications



LOCKED PN

Pneumatic Rod Clamping

Rod clamping with maximum clamping force

Jacking systems, Light presses, Punching/stamping machines,
Stacking units



LOCKED PRK

Pneumatic Rod Clamping, Compact

Rod clamping with maximum clamping force in a compact size

Jacking systems, Light presses, Punching/stamping machines,
Stacking units



LOCKED R

Pneumatic Rotational Clamping

Strong holding force on the shaft

Drive shafts, Torque motors, Conveyor systems

Application Examples

SL

Special LOCKED SL elements for emergency stops

In order to secure the processing position of a special lathe in both the horizontal and the vertical axis, ACE LOCKED elements of the type SL35-1-6B are installed. They have the further advantage of preventing slippage through the vertical axis in the case of a malfunction. The products used in the SL-series not only have the correct track width and offer very high process clamping forces of up to 2,248 lbs, but can also apply the same force as an emergency-stop braking function. This is due to the specially integrated brake linings made of low-wear sintered metal.



ACE clamping and safety elements maintain a rock-solid hold on the axes in special lathes and secure the predetermined positions both horizontally and vertically

RASOMA Werkzeugmaschinen GmbH, 04720 Döbeln, Germany

SLK

Secure rail clamping

ACE clamping elements secure machines in the tyre industry. The goods accumulator/compensator of a material dispenser carries meandering, coiled, highly tear resistant material strips, which are fed at high speed to a tyre-manufacturing machine. To prevent damaging the machine, innovative type SLK25-1-6B clamping elements are employed.



Secure material accumulator

PN

Clamping elements as a variable stop

ACE clamping elements are inserted, as a variable stop, during a joining process for the production of drilling tools. They meet the requirements for a precise positioning of the workpiece head and an adaptation of the length tolerance of up to 0.12 in, ideally. ACE was awarded the contract because the clamping element is attached on a bar and its PN LOCKED series is specifically designed for this purpose. For clamping on linear guides, rails, axles and shafts, ACE offers a great range of high-performance models.

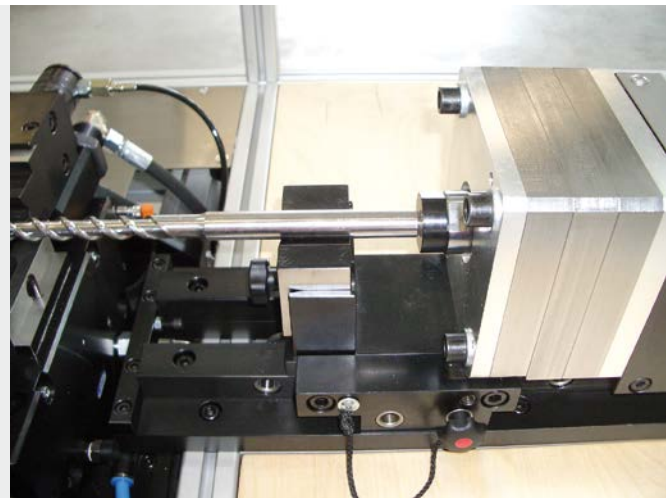

ACE clamping elements assist in the production of drilling tools: the LOCKED-P system clamps and at the same time absorbs the opposing forces of the joining process without difficulty
 GRAF automation GmbH, 88214 Ravensburg, Germany

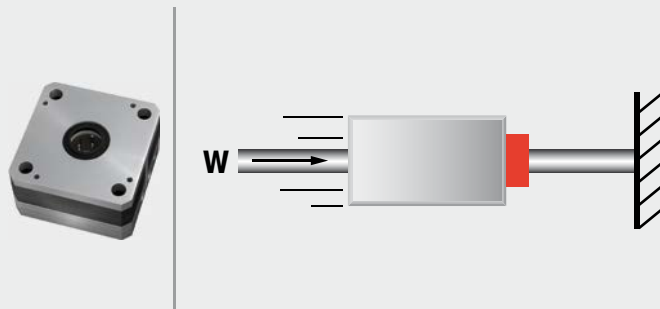

PN

Secure rod clamping

Pneumatic rod clamping allows hydraulic presses to be used for any application. With the help of hydraulic presses, cut ceramic parts are manufactured during the week. So that the rods of the upper and lower stamping plate do not sag when the press is at a standstill over the weekend or during holidays and to avoid having to be setup again on the next working day, PN80-25-2-6B rod clamps are used.

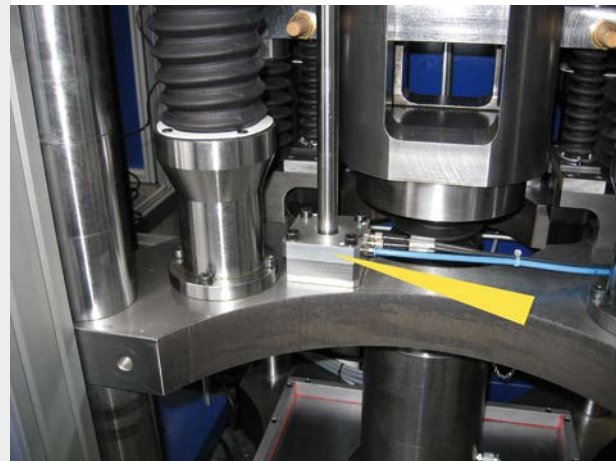

Pneumatic rod clamping allows hydraulic presses to be used for any application
 KOMAGE Gellner Maschinenfabrik KG, 54427 Kell am See, Germany



Issue 04.2018 – Specifications subject to change

| State | City | Distributor | Phone Number | Website |
|---------------|---|--|--|---|
| Alabama | Birmingham | Air Hydro Power | (205) 623-2215 | www.airhydropower.com |
| Alaska | Anchorage Kodiak Woodinville, WA | Alaska Hydraulics Alaska Hydraulics Sun Source - Warden Fluid Dynamics | (907) 562-2217 (907) 486-5970 (800) 666-0382 | www.alaskahydraulics.com www.alaskahydraulics.com www.sun-source.com |
| Arizona | Tempe Chandler | Barkley Fluid Power Sun Automation Inc. | (480) 968-7416 (480) 929-0464 | www.barkleyfluidpower.com www.sunautomationinc.com |
| Arkansas | Little Rock Fort Smith | Centro, Inc. Franklin Automation Inc. | (855) 223-6876 (479) 646-7448 | www.centro-online.com www.franklinautomation.com |
| California | Campbell Santa Ana San Jose Los Angeles San Diego | Clayton Controls Inc. Clayton Controls Inc. - HQ Nor-Cal Controls Inc. Provoast Automation Controls Provoast Automation Controls | (800) 341-4445 (800) 235-4411 (800) 233-2013 (714) 996-9417 (858) 748-2237 | www.claycon.com www.claycon.com www.norcal4air.com www.proautocon.com www.proautocon.com |
| Colorado | Englewood | AAP Automation | (303) 778-0800 | www.aapautomation.com |
| Connecticut | Bloomfield Worcester, MA Wakefield, MA | Pearse-Bertram, LLC Kinepower (KiniFac Corp) Minuteman Controls | (800) 677-1911 (508) 754-6901 (781) 245-9550 | www.pearse-bertram.com www.kinepower.com www.maseas.com |
| Delaware | Souderton, PA Maplewood, NJ Broomall, PA York, PA | Air-Oil Systems Inc. Airoyal Co., Inc. Rankin Automation RG Group | (215) 721-9595 (973) 761-4150 (610) 544-6800 (717) 849-0320 | www.airoil.com www.airoyal.biz www.rankinautomation.com www.rg-group.com |
| Florida | Oldsmar Tampa Birmingham, AL | Braas Co. Gulf Controls Corp. Air Hydro Power | (813) 855-4425 (813) 884-0471 (205) 623-2215 | www.braasco.com www.gulfcontrols.com www.airhydropower.com |
| Georgia | Stone Mountain Conyers | TSI Solutions Georgia Automation | (770) 879-3500 (770) 388-7300 | www.4tsi.com www.georgiaautomation.com |
| Hawaii | Santa Ana, CA | Clayton Controls | (800) 235-4411 | www.claycon.com |
| Idaho | Boise | SunSource - Warden Fluid Dynamics | (866) 323-4767 | www.sun-source.com |
| Illinois | Elk Grove Fenton, MO Hanover Park St. Louis, MO | FPE Automation Inc. Air Specialist Worldwide Inc. CMA/Flodyne/Hydradyne Inc. John Henry Foster Co. | (847) 364-7455 (636) 326-5900 (630) 563-3600 (314) 427-0600 | www.fpeinc.com www.airspec.com www.cmath.com www.jhf.com |
| Indiana | Indianapolis South Bend Fort Wayne | Neff Indianapolis Neff South Bend Neff Fort Wayne | (317) 841-9244 (574) 272-8282 (260) 489-6007 | www.neffautomation.com www.neffautomation.com www.neffautomation.com |
| Iowa | Merriam, KS Omaha, NE Eden Prairie, MN | IBT, Inc. Skarda Equipment Co., Inc. Hartfiel Automation | (913) 677-3151 (402) 422-0430 (952) 974-2500 | www.ibtinc.com www.skarda.com www.hartfiel.com |
| Kansas | Merriam Omaha, NE Eden Prairie, MN | IBT, Inc. Skarda Equipment Co., Inc. Hartfiel Automation | (913) 677-3151 (402) 422-0430 (952) 974-2500 | www.ibtinc.com www.skarda.com www.hartfiel.com |
| Kentucky | Louisville West Chester, OH | Air Hydro Power Henry M. Wood | (502) 451-1000 (513) 755-4060 | www.airhydropower.com www.henrymwood.com |
| Louisiana | Broussard Shreveport Memphis, TN | Hydraquip Centro Franklin Automation | (337) 837-4114 (318) 221-2347 (901) 362-7504 | www.hydraquip.com www.centrosolves.com www.franklinautomation.com |
| Maine | Bloomfield, CT Worcester, MA Wakefield, MA | Pearse-Bertram, LLC Kinepower (KiniFac Corp) Minuteman Controls | (800) 677-1911 (508) 754-6901 (781) 245-9550 | www.pearse-bertram.com www.kinepower.com www.maseas.com |
| Maryland | Baltimore Souderton, PA Fredericksburg, VA Broomall, PA York, PA | Airoyal Co., Inc. Air-Oil Systems Inc. Hartfiel Automation Rankin Automation RG Group | (866) 247-6645 (215) 721-9595 (540) 898-4511 (610) 544-6800 (717) 849-0320 | www.airoyal.biz www.airoil.com www.advpneumatics.com www.rankinautomation.com www.rg-group.com |
| Massachusetts | Worcester Wakefield Bloomfield, CT | Kinepower (KiniFac Corp) Minuteman Controls Pearse-Bertram, LLC | (508) 754-6901 (781) 245-9550 (800) 677-1911 | www.kinepower.com www.maseas.com www.pearse-bertram.com |
| Michigan | Grand Rapids Farmington Hills Hudsonville Grand Rapids Flint Flint | Bond Fluidaire Exotic Auto & Supply MFP Automation Engineering Neff Grand Rapids Neff Flint RG Kenrick Co., Inc. | (616) 942-1060 (248) 477-2122 (616) 538-5700 (616) 554-1974 (810) 232-9350 (810) 733-7440 | www.bondfluidaire.com www.exoticautomation.com www.mfp.com www.neffautomation.com www.neffautomation.com www.rgkenrick.com |
| Minnesota | Eagan Eden Prairie Eden Prairie | John Henry Foster Braas Co. Hartfiel Automation | (651) 452-8452 (800) 288-6628 (952) 974-2500 | www.jhfoster.com www.braasco.com www.hartfiel.com |
| Mississippi | Little Rock, AR Memphis, TN | Centro Inc. Franklin Automation Inc. | (855) 223-6876 (630) 466-1900 | www.centro-online.com www.franklinautomation.com |
| Missouri | Fenton St. Louis Merriam, KS | Air Specialist Worldwide Inc. John Henry Foster Co. IBT, Inc. | (636) 326-5900 (314) 427-0600 (913) 677-3151 | www.airspec.com www.jhf.com www.ibtinc.com |
| Montana | Spokane Valley, WA | SunSource - Warden Fluid Dynamics | (800) 234-8265 | www.sun-source.com |
| Nebraska | Omaha Merriam, KS | Skarda Equipment Co., Inc. IBT, Inc. | (402) 422-0430 (913) 677-3151 | www.skarda.com www.ibtinc.com |
| Nevada | Campbell, CA Santa Ana, CA San Jose, CA Los Angeles, CA | Clayton Controls Inc. Clayton Controls Inc. Nor-Cal Controls Inc. Provoast Automation Controls | (800) 341-4445 (800) 235-4411 (800) 233-2013 (714) 996-9417 | www.claycon.com www.claycon.com www.norcal4air.com www.proautocon.com |
| New Hampshire | Bloomfield, CT Worcester, MA Wakefield, MA | Pearse-Bertram, LLC Kinepower (KiniFac Corp) Minuteman Controls | (800) 677-1911 (508) 754-6901 (781) 245-9550 | www.pearse-bertram.com www.kinepower.com www.maseas.com |



| State | City | Distributor | Phone Number | Website |
|-----------------------|---|---|--|---|
| New Jersey | Maplewood Broomall, PA York, PA | Airoyal Co., Inc. Rankin Automation RG Group | (973) 761-4150 (610) 544-6800 (717) 849-0320 | www.airoyal.biz www.rankinautomation.com www.rg-group.com |
| New Mexico | Tempe, AZ | Barkley Fluid Power | (480) 968-7416 | www.barkleyfluidpower.com |
| New York | Syracuse Rochester | Ralph W. Earl Co, Inc. Airoyal Co., Inc. Empire Automation | (315) 454-4431 (973) 761-4150 (585) 352-3333 | www.rwearl.com www.airoyal.biz www.maseas.com |
| North Carolina | Concord Concord | Automation Technology Inc. Hartfiel Automation | (704) 784-8101 (704) 788-1240 | www.automationtechnologyinc.com www.hartfiel.com |
| North Dakota | Eagan, MN Eden Prairie, MN | John Henry Foster Braas Co. | (651) 452-8452 (800) 288-6628 | www.jhfoster.com www.braasco.com |
| Ohio | Westlake West Chester Bath Franklin Fairfield | Neff Engineering Henry M. Wood Mann Fluid Power Voelker Controls Co. JWF Technologies | (440) 835-7010 (513) 755-4060 (330) 659-6671 (800) 686-4762 (513) 769-9611 | www.neffautomation.com www.henrymwood.com www.mannfluidpower.com www.voelker-controls.com www.jwftechnologies.com |
| Oklahoma | Allen, TX | Shepherd Controls Hydraquip Southwestern Controls | (972) 727-7300 (713) 680-1951 (214) 638-4266 | www.shepherdcontrols.com www.hydraquip.com www.southwesterncontrols.com |
| Oregon | Portland Vancouver, WA | Northwest Automation Products SunSource - Warden Fluid Dynamics | (503) 620-5670 (800) 444-4946 | www.northwestpneumatics.com www.sun-source.com |
| Pennsylvania | Souderton Warrendale Warrendale Aliquippa Broomall York Fairfield | Air-Oil Systems Inc. Airoyal Co., Inc. Huston Industrial Sales, Inc. Neff Pennsylvania Pennsylvania Controls Rankin Automation RG Group JWF Technologies | (215) 721-9595 (973) 761-4150 (724) 935-5666 (724) 776-5669 (724) 378-9454 (610) 544-6800 (717) 849-0320 (513) 769-9611 | www.airoil.com www.airoyal.biz www.hustonind.com www.neffautomation.com www.4pacco.com www.rankinautomation.com www.rg-group.com www.jwftechnologies.com |
| Rhode Island | Bloomfield, CT Worcester, MA Wakefield, MA | Pearse-Bertram, LLC Kinepower (KiniFac Corp) Minuteman Controls | (800) 677-1911 (508) 754-6901 (781) 245-9550 | www.pearse-bertram.com www.kinepower.com www.maseas.com |
| South Carolina | Concord, NC Concord, NC | Automation Technology Inc. Hartfiel Automation | (704) 784-8101 (704) 788-1240 | www.automationtechnologyinc.com www.hartfiel.com |
| South Dakota | Eagan, MN Eden Prairie, MN | John Henry Foster Braas Co. | (651) 452-8452 (800) 288-6628 | www.jhfoster.com www.braasco.com |
| Tennessee | Memphis Memphis Knoxville Dickson | Centro Inc. Franklin Automation Inc. Leinart's Inc. Modern Automation | (901) 357-1261 (901) 362-7504 (865) 525-0363 (615) 446-1990 | www.centrosolves.com www.franklinautomation.com www.leinarts.net www.modernaautomation.com |
| Texas | El Paso Allen | Itech Automation Solutions Shepherd Controls Southwestern Controls Hydraquip | (915) 599-3022 (972) 727-7300 (214) 638-4266 (713) 680-1951 | www.itechelpaso.com www.shepherdcontrols.com www.southwesterncontrols.com www.hydraquip.com |
| Utah | Murray | AAP Automation | (801) 207-2400 | www.aapautomation.com |
| Vermont | Bloomfield, CT Worcester, MA Wakefield, MA | Pearse-Bertram, LLC Kinepower (KiniFac Corp) Minuteman Controls | (800) 677-1911 (508) 754-6901 (781) 245-9550 | www.pearse-bertram.com www.kinepower.com www.maseas.com |
| Virginia | Fredericksburg Roanoke | Hartfiel Automation Maxim Systems, Inc. | (540) 898-4511 (540) 265-9050 | www.advpneumatics.com www.maximsystems.net |
| Washington | Kent Spokane Valley Vancouver Woodinville Portland, OR | Northwest Automation Products SunSource - Warden Fluid Dynamics SunSource - Warden Fluid Dynamics SunSource - Warden Fluid Dynamics Northwest Automation Products | (425) 251-9995 (800) 234-8265 (800) 444-4946 (800) 666-0382 (503) 620-5670 | www.northwestpneumatics.com www.sun-source.com www.sun-source.com www.sun-source.com www.northwestpneumatics.com |
| West Virginia | Fredericksburg | Hartfiel Automation | (540) 898-4511 | www.advpneumatics.com |
| Wisconsin | Mequon | NEFF - Wisconsin | (262) 834-6300 | www.neffautomation.com |
| Wyoming | Englewood, CO | AAP Automation | (303) 778-0800 | www.aapautomation.com |

CANADA

| | | | | |
|---|---------------------------------------|-----------------------------|----------------------------------|--|
| Alberta & Northwest Territories | Edmonton | Peerless Engineering | (780) 439-3322 | www.peerlessengineering.com |
| British Columbia & Yukon Territory | Burnaby Prince George | Peerless Engineering - HQ | (604) 659-4100 (250) 563-2130 | www.peerlessengineering.com www.peerlessengineering.com |
| Ontario, Quebec & Maritimes | Lachine, Quebec Brantford, Ontario | Cowper Incorporated ASCO | (888) 506-1111 (519) 758-2700 | www.cowper.ca www.asco.com/en-ca |
| Saskatchewan | Prince Albert | Peerless Engineering | (306) 763-4465 | www.peerlessengineering.com |

CENTRAL AMERICA

| | | | | |
|---|----------------------|--|----------------------------------|--|
| Costa Rica | San José | Grupo Kopar | (506) 2290-6905 | www.kopar.com.mx |
| Mexico | Monterrey Tijuana | Grupo Kopar Provoast Automation Controls | (81) 8000-2000 (664) 647-3363 | www.kopar.com.mx www.proautocon.com |
| Puerto Rico & Dominican Republic | San Juan, PR | Rafael Benitez Carrillo, Inc./ Applied Industries | (787) 751-7500 | www.applied.com/international-puertorico |

ACE Controls Inc.
The shortest way to the perfect shock absorber



ACE Controls International Inc.

23435 Industrial Park Drive
Farmington Hills, Michigan 48335
USA

T +1 (248) - 476-0213
F +1 (248) - 476-2470



shocks@acecontrols.com
www.acecontrols.com

Global but always near
International ACE Sales Locations



GERMANY
ACE Stoßdämpfer GmbH
Albert-Einstein-Straße 15
40764 Langenfeld, Germany
T +49 (0)2173 - 9226-4100
F +49 (0)2173 - 9226-89
www.ace-ace.com



GREAT BRITAIN
ACE Fabreeka UK
Unit 404 Easter Park, Haydock Lane
Haydock, WA11 9TH, U.K.
T +44 (0)1942 - 727 440
F +44 (0)1942 - 717 273
www.ace-controls.co.uk



JAPAN
ACE Controls Japan L.L.C.
City Center Bldg. II 2fl
3-1-42, Chigasaki-minami, Tsuzuki-ku
Yokohama, 224-0037, Japan
T +81 (0)45 - 945-0123
F +81 (0)45 - 945-0122
www.acecontrols.co.jp

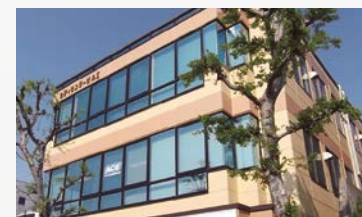

P.R. CHINA
ACE Controls
No. 8 Longxiang Road, Wujin National High-tech Industrial Zone,
Changzhou, Jiangsu Province, CN-213164, P. R. China
T +86 (0)519 - 8622-3520
F +86 (0)519 - 8622-3550
www.ace-ace.cn

