

Everything you need to know about
Airpel Anti-Stiction[®] air cylinders.



Airpel[®]
The Anti-Stiction[®] Air Cylinder.

Airpel at a Glance

- 1** Stiction: The Air Cylinder Problem
- 2** Features
- 3** Stiction, Not the Only Problem Solved
- 4** Performance Specifications: Imperial & Metric
- 6** Model E9 .366" bore – Imperial
- 8** Model E16 .627" bore – Imperial
- 10** Model E24 .945" bore – Imperial
- 12** Model M9 9.3 mm bore – Metric
- 14** Model M16 15.9 mm bore – Metric
- 16** Model M24 24 mm bore – Metric
- 18** Model M32 32.5 mm bore – Metric
- 19** The Company Behind Airpel
- 20** Other Precision Products

**Airpel Division ■ Airpot Corporation ■ 35 Lois Street
Norwalk, CT 06851 ■ 1-800-848-7681 ■ Fax: 203-849-0539
E-mail: service@airpot.com ■ www.airpot.com**

Stiction: The air cylinder problem that wouldn't go away—just did.

You encounter problems like stiction every day.

They're the kind of problems that have been around so long, people just assume they'll always be here.

Problems like collar buttons that pop off, tires that go flat, fishing lines that get all tangled up – and on and on.

Nobody devotes much time to solving problems like these. They're just part of life.

Take stiction. It's been around since the discovery of friction. And one of the places it's made itself right at home is in air cylinders.

Just what is stiction? It's that notorious affliction that causes air cylinders to stick at the start of a stroke – resulting in erratic breakaway motion.

Technically, it's the difference between static friction and moving friction when the static friction is higher.

The Airpel Air Cylinder does away with any perceptible stiction. And reduces running friction to exceedingly low levels. This gives

it the unique ability to impart super smooth motion – motion smoother than any other air cylinder. Even at very low pressures. Even at very slow speeds. Even with very short strokes.

Even after standing idle for years!

How do you account for this remarkable performance?

The Airpel incorporates a unique construction to become an instrument-quality air cylinder. It uses a precision fit graphite piston which slides freely – *without lubrication* – inside a Pyrex® glass cylinder. This makes it ideal for forces from a very few grams to 70 lbs. or more.

In fact, Airpel is particularly well-suited to applications requiring smooth motion at ultra-low pressures – and to moving lightweight objects or delicate loads at slow or high speeds. It is also ideal for providing precise force control and counterbalancing.

But this air cylinder is no weakling. It can be used to provide brute forces, too – operating under *extreme temperatures*, at very high speeds and cycle rates, with no degradation in performance.

It also *runs cleaner* than typical air cylinders because it contains no oil or grease. What's more, it has no rubber or plastic seals to abrade, wear out, or harden with time.

And because all exposed surfaces (except pivot model bushings) are stainless steel and nickel, Airpel is extremely clean and corrosion resistant.

AIRPEL VS. TYPICAL AIR CYLINDERS

Pressure vs. Static Friction (5/8" bore air cylinders)

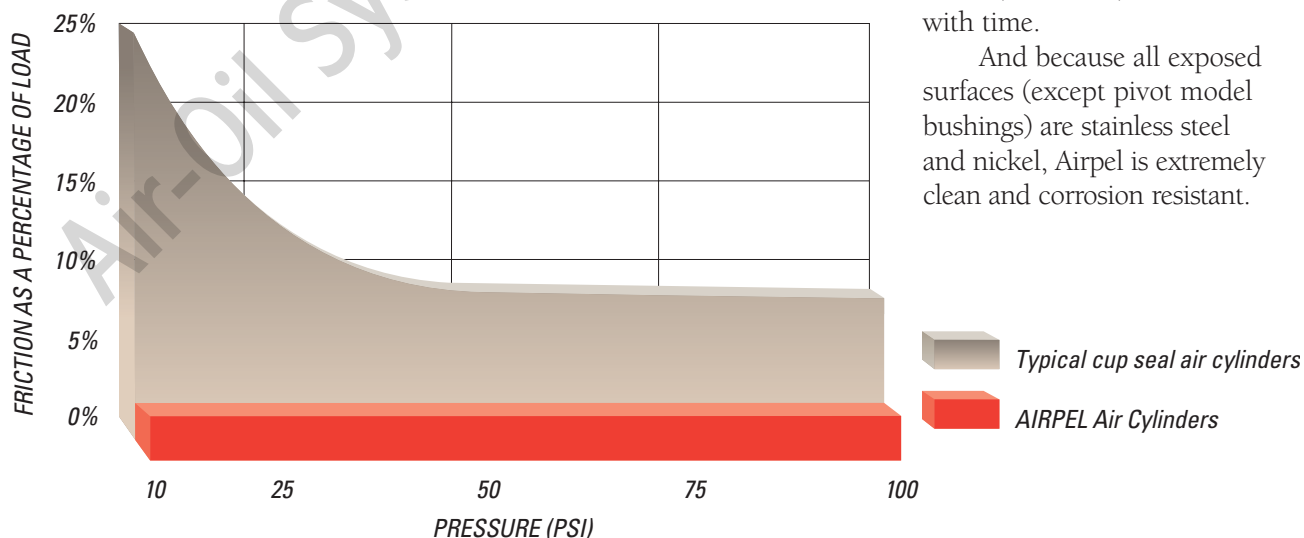

Features that could be viewed as shortcomings are actually advantages in Airpel.

An air cylinder as revolutionary as Airpel is bound to have features that raise questions. We want you to know these Airpel design points right up front, so you can weigh their importance objectively, and evaluate the benefits they provide in relation to your specific requirements.

“The Airpel leaks air.”

Advantage: Ultra-low friction.

In conventional air cylinders, there’s a design trade-off: No air leakage (when new) in exchange for higher stiction and running friction.

With Airpel, we chose to go the other way. A little air leakage (not relevant in most applications) in return for ultra-low friction.

To eliminate the leakage would require interference fits between the seal and piston rod, and between the piston and cylinder.

Such interference fits create high friction. A condition far more detrimental than a small air loss.

“The Airpel has a glass liner.”

Advantage: No corrosion, and no need for lubrication.

Obviously glass is more fragile than steel. So Airpel’s glass liner is encased in a stainless steel sleeve with a small space between. The space provides excellent impact protection, so much so that the outside wall can be dented without affecting the glass liner.

The Airpel can also withstand high stresses without bursting. Our pressure rating of 100 psi is conservative and well within its stress limits.

In fact, if you handle the Airpel the way you would any precision component, you needn’t worry about glass breakage at all.

In our reliability testing, we purposely abused the Airpel by striking it with a wedge-shaped 10-lb. weight. The steel cylinder dented, but the piston kept running smoothly

inside the undamaged glass liner. (If you dent a conventional air cylinder, you can expect its operation to be severely impaired because the piston rides against the exposed cylinder.)

We even went to the extreme of striking the cylinder with enough force to smash the glass liner while it was under full pressure. Even at this extreme, the outer cylinder stayed completely intact and, with air lines covering the ports, the glass remained within the cylinder.

What other benefits are there to our Pyrex glass liner?

Its fire-polished surface is inherently smooth and works especially well with our graphite piston to avoid the friction of metals and elastomers.

It doesn’t dent, scratch easily, corrode, or ever need lubrication.

And it’s dimensionally stable over extreme temperatures without breaking or deforming.

“Airpel configurations are limited.”

Advantage: Lower costs.

With Airpel you don’t need 20 different bore sizes. Its anti-stick slip and low friction allow it to cover an enormous mix of pressures and forces with fewer models than conventional air cylinders.

The mountings and strokes were also selected to suit the vast majority of applications in this specialized area of response.

Of course, if one of our standard models cannot meet your needs, we will gladly consider custom modifications for OEMs whenever practical, which in our case, is any time you need us.

S

tiction isn't the only problem we've solved.

Since the Airpel air cylinder is so radically different from ordinary air cylinders, we thought we'd keep on going and change something else:

The way they're sold

Airpel cylinders can be purchased through a select network of authorized distributors; we encourage you to contact them whenever possible. Our first interest, however, is insuring that you get what you need, when you need it. So Airpel cylinders can be ordered direct from Airpot Corporation at any time.

Even more importantly, you are not locked into using standard models. Many of our most successful applications have involved customized Airpel constructions developed through collaboration between our engineers and our customers. All Airpot application engineers are also design engineers, so your contact at Airpot will not only be your source of technical informa-



tion, but also the designer and engineering supervisor of any custom configuration we produce for your application.

Whether your special need is as simple as an odd stroke or rod length, or as extreme as a 1/2-inch-high cylinder, we are happy to consider your new ideas and uncommon uses for our products. We encourage you to discuss your novel requirements with us.

In short, we'll do everything humanly and technically possible to assist with your ordering needs. That includes credit card purchasing, JIT and ship-to-the-line deliveries, liberal rescheduling and cancellation policies, and rapid response to all inquiries, requests, and emergency situations.

For complete details on ordering, whether from our distributor, direct from factory, off-the-shelf, or for custom units, please call us.

Airpel CONSTRUCTION

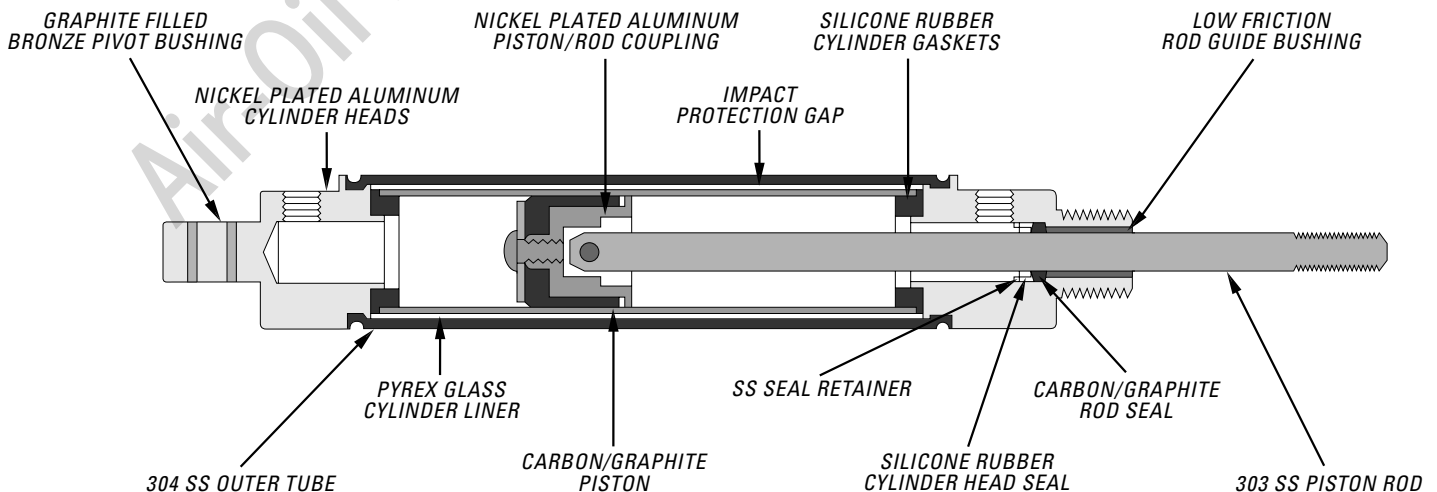

P

PERFORMANCE

Imperial



MODEL	<u>E9</u>	<u>E16</u>	<u>E24</u>
BORE (inches)	0.366	0.627	0.945
PISTON AREA (sq. inch)	0.105	0.307	0.701
PRESSURE RANGE: FULL VACUUM TO-(PSI)	100	100	100
FORCE OUTPUT AT MAX PRESSURE ON REAR SIDE (lbs)	10.5	30.7	70.1
FORCE OUTPUT AT MAX PRESSURE ON ROD SIDE (lbs)	9.3	27.6	65.2
FORCE FACTOR REAR SIDE (factor x pressure = force output)	0.105	0.307	0.701
FORCE FACTOR ROD SIDE (factor x pressure = force output)	0.093	0.276	0.652
MIN PRESSURE DIFFERENTIAL REQUIRED FOR ACTUATION (PSI)	<0.2	<0.2	<0.2
PISTON FRICTION AS % OF LOAD (without side load)	1%–2%	1%–2%	1%–2%
OPERATING TEMPERATURE RANGE	-55° C to +150° C	-55° C to +150° C	-55° C to +150° C
WEIGHT OF PISTON/ROD ASSY (grams)			
Single rod end models	4.5 + (1.36 x Stroke)	16 + (3.6 x Stroke)	40.64 + (6.46 x Stroke)
Double rod end models	9.93 + (3.24 x Stroke)	29.08 + (8.00 x Stroke)	73.28 + (12.92 x Stroke)
WEIGHT OF COMPLETE UNIT (grams)			
Single rod end models	31.7 + (9.52 x Stroke)	64.6 + (15.8 x Stroke)	156.42 + (31.12 x Stroke)
Double rod end models	38.46 + (11.74 x Stroke)	84.49 + (21.68 x Stroke)	203.9 + (37.58 x Stroke)

MAX LEAK AT REFERENCE PRESSURES

AT PRESSURE PSI=	50	50	50
MAX LEAK RATE by Piston: SL / min*	1.16	1.39	2.2
MAX LEAK RATE by Rod: SL / min*	2.2	2.6	2.6

Airpel Handling and Mounting Recommendations

■ Tightening torque on mounting nuts should not exceed 60 lb.-in. ■ When threading Airpel directly into a tapped hole, or when tightening the mounting nut, apply tightening/ support wrench to the end being mounted only. ■ The Airpel never needs lubrication. Lubrication applied to any part of the Airpel can impair its Anti-Stiction, low friction properties. ■ For optimum performance, supply air should be filtered using at least a 5 micron, coalescing filter. ■ Do not bottom out the piston under pressure as it can damage the unit. ■ To achieve the lowest possible friction, mount unit so that side loading of the piston rod is minimized. Forceful side loads or side impact on piston rod may damage the unit. NOTE: An unmounted piston rod which does not move freely may indicate cylinder damage. If this condition is present, do not attempt to operate air cylinder. ■ CAUTION: NEVER PRESSURIZE THE AIRPEL WITH ANY PORTS OPEN TO THE ATMOSPHERE. As with any air cylinder, always keep open ports pointed away from eyes. If pneumatic circuit requires an open port, we recommend screening the port with a muffler, filter, or flow control valve.

SPECIFICATIONS



Metric

MODEL	<u>M9</u>	<u>M16</u>	<u>M24</u>	<u>M32</u>
BORE (mm)	9.3	15.9	24.0	32.5
PISTON AREA (sq. mm)	67.7	198	452.5	830
MAX PRESSURE: (MPa)	0.7	0.7	0.7	0.7
SUITABLE FOR VACUUM ACTUATION?	Yes	Yes	Yes	No
FORCE OUTPUT AT MAX PRESSURE ON REAR SIDE (Newtons)	47.4	139	316.6	581
FORCE OUTPUT AT MAX PRESSURE ON ROD SIDE (Newtons)	42	125	294.5	526
Force factor Rear Side (factor x pressure[MPa]=force output [N])	67.7	198	452.5	830
Force factor Rod Side (factor x pressure[MPa]=force output [N])	60	178	420.8	751
MIN PRESSURE DIFFERENTIAL REQUIRED FOR ACTUATION (MPa)	< 0.0015	< 0.0015	< 0.0015	< 0.0035
PISTON FRICTION AS % OF LOAD (without side load)	1%–2%	1%–2%	1%–2%	1%–2%
OPERATING TEMPERATURE RANGE	-55° C to +150° C	-55° C to +150° C	-55° C to +150° C	-55° C to +150° C
WEIGHT OF PISTON/ROD ASSY (grams)				
Single rod end models	4.5 + (0.053 x Stroke)	16 + (0.142 x Stroke)	41.4 + (0.254 x Stroke)	82.6 + (0.56 x Stroke)
Double rod end models	8.87 + (0.064 x Stroke)	28.48 + (0.315 x Stroke)	74.28 + (0.509 x Stroke)	
WEIGHT OF COMPLETE UNIT (grams)				
Single rod end models	31.7 + (0.375 x Stroke)	64.6 + (0.622 x Stroke)	157.18 + (1.225 x Stroke)	616 + (3.66 x Stroke)
Double rod end models	41.02 + (0.462 x Stroke)	80.45 + (0.854 x Stroke)	204.9 + (1.480 x Stroke)	
MAX LEAK AT REFERENCE PRESSURES				
AT PRESSURE MPa=	0.34	0.34	0.34	0.34
MAX LEAK RATE by Piston: SL / min*	1.16	1.39	2.2	2.2
MAX LEAK RATE by Rod: SL / min*	2.2	2.6	2.6	2.0

*NOTE: Lower leak rates are available for both Imperial and Metric models upon request. Please consult an Airpot applications engineer by calling (800) 848-7681 or by e-mailing engineering@airpot.com.

Model E9

Bore Size

.366 inch

Pressure Range

< 0.2 to 100 psi

Force Factors

Factor times pressure (psi) equals output force (lbs.)

- Rear side .105
- Rod side .093

Friction Under Pressure

Typically 1%–2% of load in all models

Temperature Range

-55° Celsius to +150° Celsius
(-67° F to +302° F)

Note: For applications operating below -20° C, it is necessary to add “-ET” to the part number. For example: Model E9D1.0N-ET

Weight of piston/rod assembly (grams)

Single rod end models
4.5 + (1.36 x Stroke)

Double rod end models
9.93 + (3.24 x Stroke)

Weight (max.) of complete unit (grams)

Single rod end models
31.7 + (9.52 x Stroke)

Double rod end models
38.46 + (11.74 x Stroke)

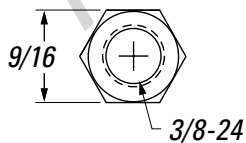

Mounting nut included for all units

DOUBLE ACTING UNITS

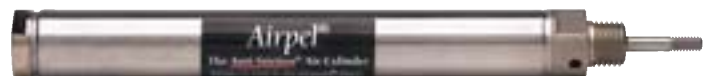
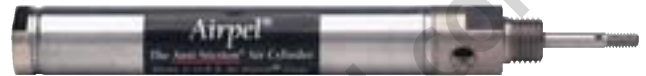

Part #: E9D...U
STROKE

Strokes:

- 0.5-1.0-1.5-2.0-
- 3.0-4.0-5.0-6.0-7.0-
- 8.0-9.0-10.0-11.0-12.0

Universal mount includes:

- Rear pivot mount
- Front, rear stud mount

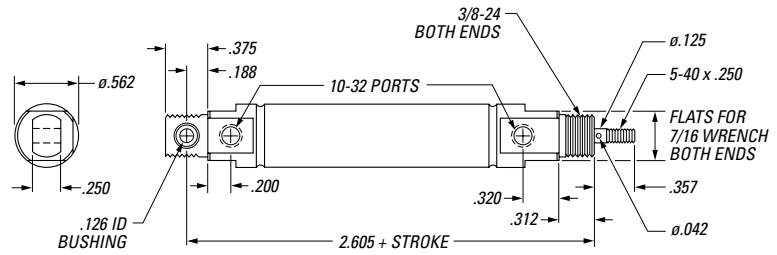

Part #: E9D...N
STROKE

Strokes:

- 0.5-1.0-1.5-2.0-
- 3.0-4.0-5.0-6.0-7.0-
- 8.0-9.0-10.0-11.0-12.0

Front stud mount

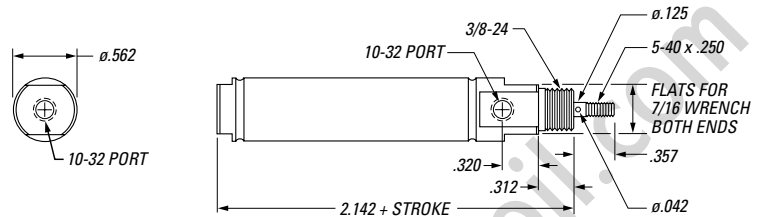

Part #: E9D...S
STROKE

Strokes:

- 0.5-1.0-1.5-2.0-
- 3.0-4.0-5.0-6.0-7.0-
- 8.0-9.0-10.0-11.0-12.0

Front, rear stud mount

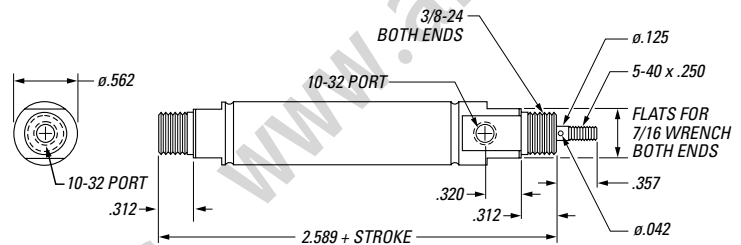

Part #: E9D...D
STROKE

Strokes:

- 0.5-1.0-1.5-2.0-
- 3.0-4.0-5.0-6.0-7.0-
- 8.0-9.0-10.0-11.0-12.0

Double rod end

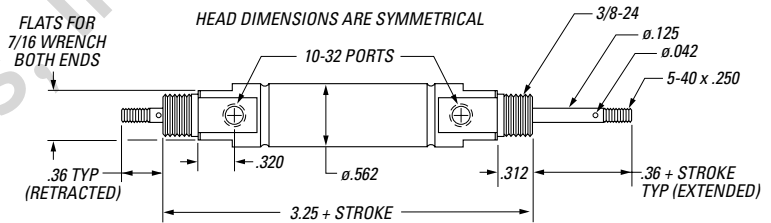

Part #: E9X...U
STROKE

Air extend, spring return

Strokes: 0.5-1.0-1.5

Universal mount includes:

- Rear pivot mount
- Front, rear stud mount

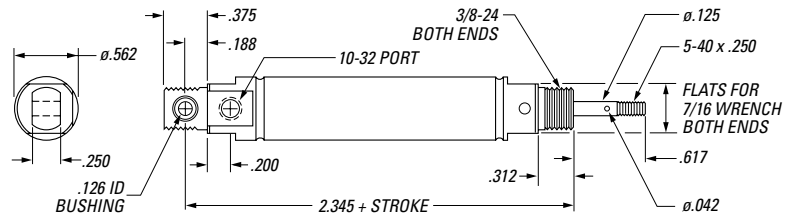

RESET SPRING FORCE FOR SINGLE ACTING UNITS (lbs.)			
Stroke	0.5	1.0	1.5
Rod Extended	.17	.17	.17
Rod Retracted	.12	.08	.05

Part #: E9X...N
STROKE

Air extend, spring return

Strokes: 0.5-1.0-1.5

Front stud mount

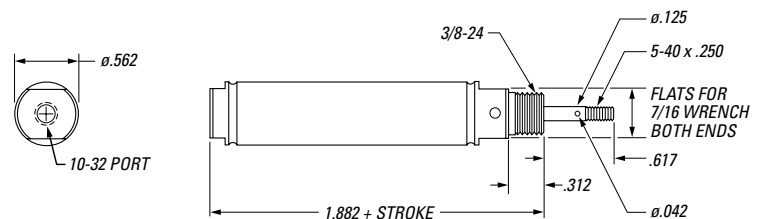

Model E16

Bore Size

.627 inch

Pressure Range

< 0.2 to 100 psi

Force Factors

Factor times pressure (psi) equals output force (lbs.)

- Rear side .307
- Rod side .276

Friction Under Pressure

Typically 1%–2% of load in all models

Temperature Range

-55° Celsius to +150° Celsius
(-67° F to +302° F)

Note: For applications operating below -20° C, it is necessary to add “-ET” to the part number. For example: Model E16D1.0N-ET

Weight of piston/rod assembly (grams)

Single rod end models
16 + (3.6 x Stroke)

Double rod end models
29.08 + (8.00 x Stroke)

Weight (max.) of complete unit (grams)

Single rod end models
64.6 + (15.8 x Stroke)

Double rod end models
84.49 + (21.68 x Stroke)

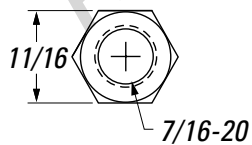

Mounting nut included for all units

DOUBLE ACTING UNITS



SINGLE ACTING UNITS

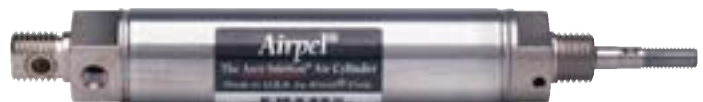

Part #: E16D_{STROKE}..U

Strokes:

- 0.5-1.0-1.5-2.0-
- 3.0-4.0-5.0-6.0-7.0-
- 8.0-9.0-10.0-11.0-12.0

Universal mount includes:

- Rear pivot mount
- Front, rear stud mount

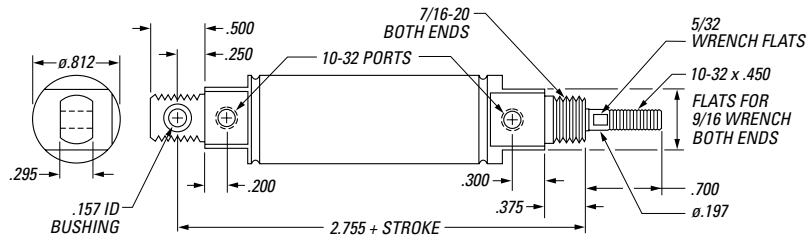

Part #: E16D_{STROKE}..N

Strokes:

- 0.5-1.0-1.5-2.0-
- 3.0-4.0-5.0-6.0-7.0-
- 8.0-9.0-10.0-11.0-12.0

Front stud mount

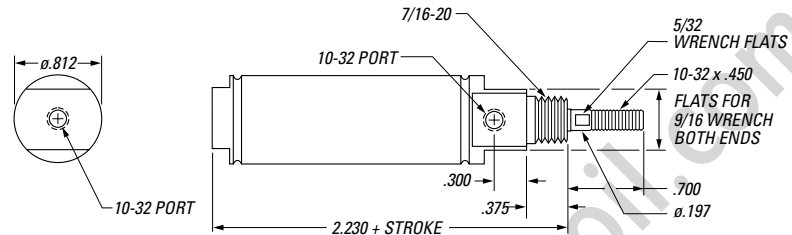

Part #: E16D_{STROKE}..S

Strokes:

- 0.5-1.0-1.5-2.0-
- 3.0-4.0-5.0-6.0-7.0-
- 8.0-9.0-10.0-11.0-12.0

Front, rear stud mount

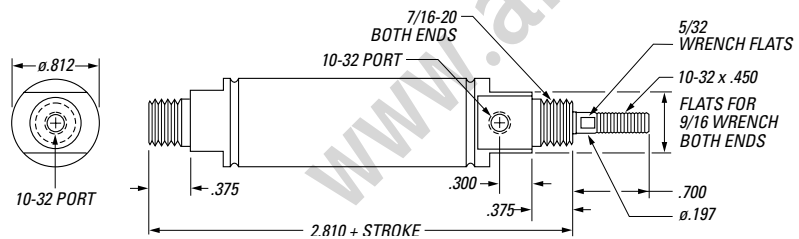

Part #: E16D_{STROKE}..D

Strokes:

- 0.5-1.0-1.5-2.0-
- 3.0-4.0-5.0-6.0-7.0-
- 8.0-9.0-10.0-11.0-12.0

Double rod end

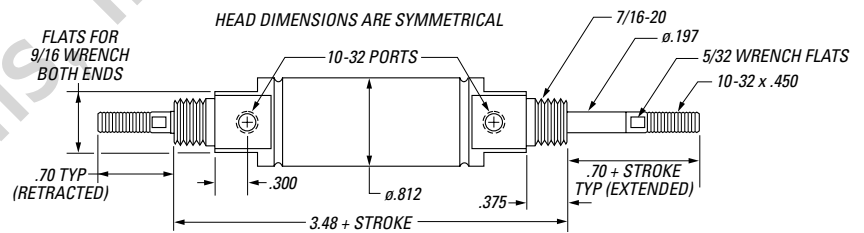

Part #: E16X_{STROKE}..U

Air extend, spring return

Strokes: 0.5-1.0-1.5-2.0

Universal mount includes:

- Rear pivot mount
- Front, rear stud mount

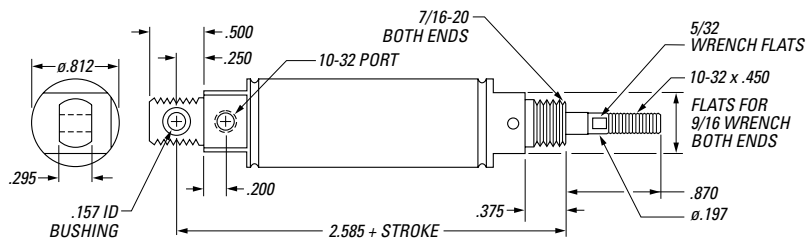

RESET SPRING FORCE FOR SINGLE ACTING UNITS (lbs.)				
Stroke	0.5	1.0	1.5	2.0
Rod Extended	.25	.25	.25	.25
Rod Retracted	.22	.20	.17	.15

Part #: E16X_{STROKE}..N

Air extend, spring return

Strokes: 0.5-1.0-1.5-2.0

Front stud mount

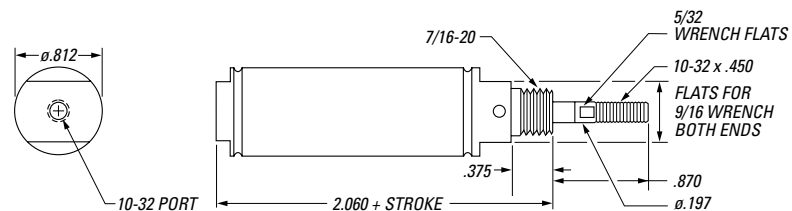

Model E24

Bore Size

.945 inch

Pressure Range

< 0.2 to 100 psi

Force Factors

Factor times pressure (psi) equals output force (lbs.)

- Rear side .701
- Rod side .652

Friction Under Pressure

Typically 1%–2% of load in all models

Temperature Range

-55° Celsius to +150° Celsius
(-67° F to +302° F)

Note: For applications operating below -20° C, it is necessary to add “-ET” to the part number. For example: Model E24D1.0N-ET

Weight of piston/rod assembly (grams)

Single rod end models
40.6 + (6.46 x Stroke)

Double rod end models
73.28 + (12.92 x Stroke)

Weight (max.) of complete unit (grams)

Single rod end models
156.4 + (31.12 x Stroke)

Double rod end models
203.9 + (37.58 x Stroke)

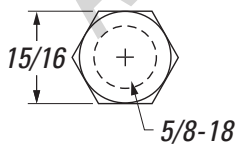

Mounting nut included for all units

DOUBLE ACTING UNITS



SINGLE ACTING UNITS



Part #: E24D_{STROKE}...U

Strokes:

- 0.5-1.0-1.5-2.0-
- 3.0-4.0-5.0-6.0-7.0-
- 8.0-9.0-10.0-11.0-12.0

Universal mount includes:

- Rear pivot mount
- Front, rear stud mount

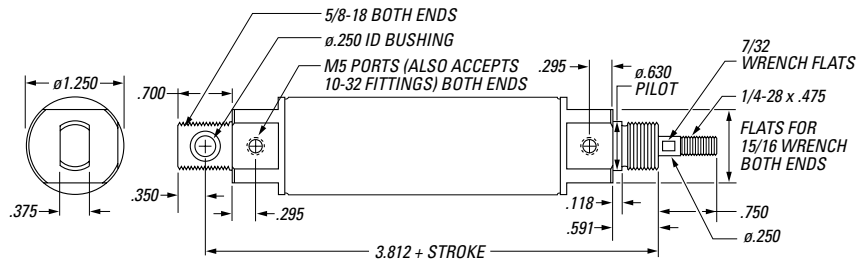

Part #: E24D_{STROKE}...N

Strokes:

- 0.5-1.0-1.5-2.0-
- 3.0-4.0-5.0-6.0-7.0-
- 8.0-9.0-10.0-11.0-12.0

Front stud mount

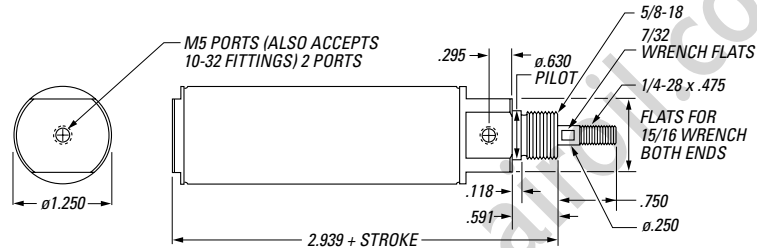

Part #: E24D_{STROKE}...D

Strokes:

- 0.5-1.0-1.5-2.0-
- 3.0-4.0-5.0-6.0-7.0-
- 8.0-9.0-10.0-11.0

Double rod end

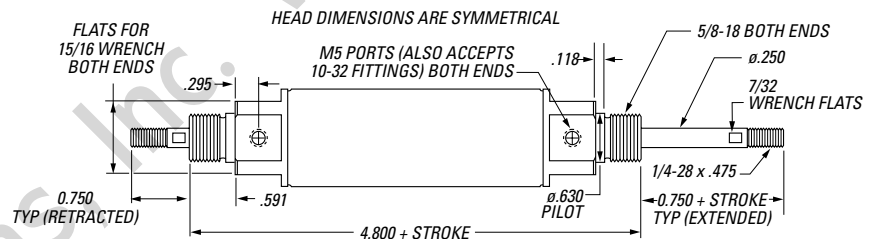

Part #: E24X_{STROKE}...U

Air extend, spring return

Strokes: 0.5-1.0-1.5-2.0

Universal mount includes:

- Rear pivot mount
- Front, rear stud mount

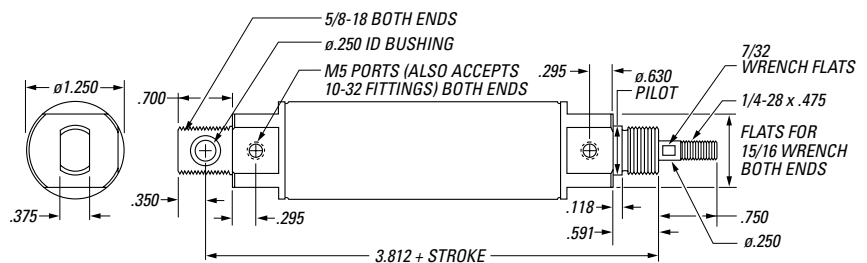

RESET SPRING FORCE FOR SINGLE ACTING UNITS (lbs.)				
Stroke	0.5	1.0	1.5	2.0
Rod Extended	.32	.32	.32	.32
Rod Retracted	.32	.28	.26	.24

Part #: E24X_{STROKE}...N

Air extend, spring return

Strokes: 0.5-1.0-1.5-2.0

Front stud mount

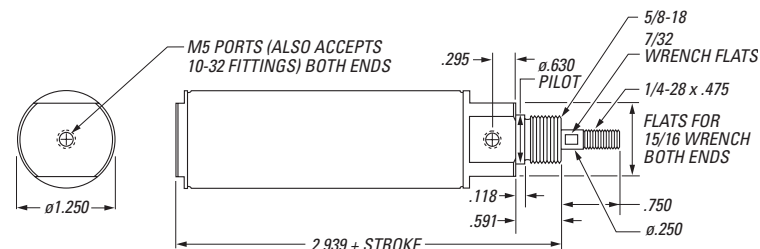

Model M9

Bore Size

9.3 mm

Pressure Range

< 0.0015 to 0.7 MPa

Force Factors

Factor times pressure (MPa) equals output force (newtons)

- Rear side 67.7
- Rod side 60.0

Friction Under Pressure

Typically 1%–2% of load in all models

Temperature Range

-55° Celsius to +150° Celsius
(-67° F to +302° F)

Note: For applications operating below -20° C, it is necessary to add “-ET” to the part number.
For example: Model M9D25.0N-ET

Weight of piston/rod assembly (grams)

Single rod end models
 $4.5 + (0.063 \times \text{Stroke})$

Double rod end models
 $8.87 + (0.13 \times \text{Stroke})$

Weight (max.) of complete unit (grams)

Single rod end models
 $31.7 + (0.375 \times \text{Stroke})$

Double rod end models
 $41.02 + (0.462 \times \text{Stroke})$

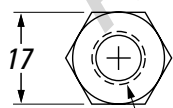

M10 x 1.5



Mounting nut included for all units

DOUBLE ACTING UNITS

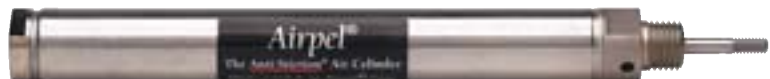

Part #: M9D...U
STROKE

Strokes:

12.5–25.0–37.5–50.0–75.0–
100.0–125.0–150.0–175.0–
200.0–225.0–250.0–275.0–300.0

Universal mount includes:

- Rear pivot mount
- Front, rear stud mount

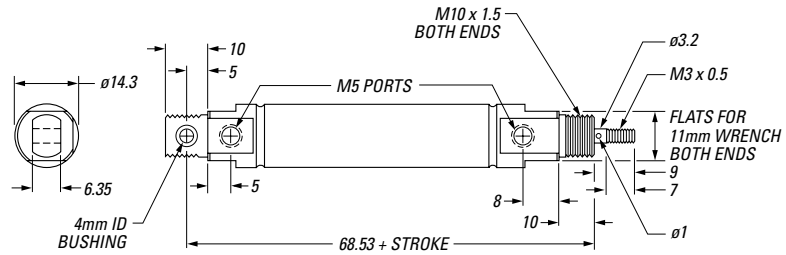

Part #: M9D...N
STROKE

Strokes:

12.5–25.0–37.5–50.0–75.0–
100.0–125.0–150.0–175.0–
200.0–225.0–250.0–275.0–300.0

Front stud mount

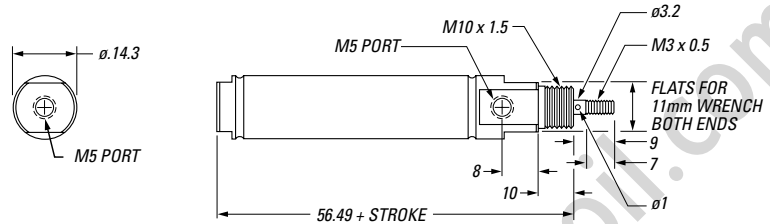

Part #: M9D...S
STROKE

Strokes:

12.5–25.0–37.5–50.0–75.0–
100.0–125.0–150.0–175.0–
200.0–225.0–250.0–275.0–300.0

Front, rear stud mount

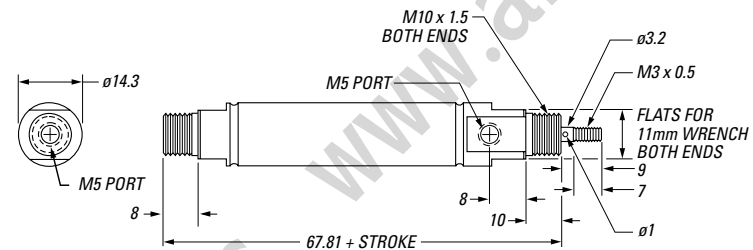

Part #: M9D...D
STROKE

Strokes:

12.5–25.0–37.5–50.0–75.0–
100.0–125.0–150.0–175.0–
200.0–225.0–250.0–275.0–300.0

Double rod end

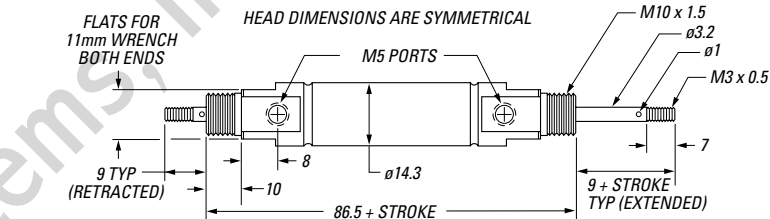

Part #: M9XD...U
STROKE

Air extend, spring return

Strokes: 12.5–25.0–37.5

Universal mount includes:

- Rear pivot mount
- Front, rear stud mount

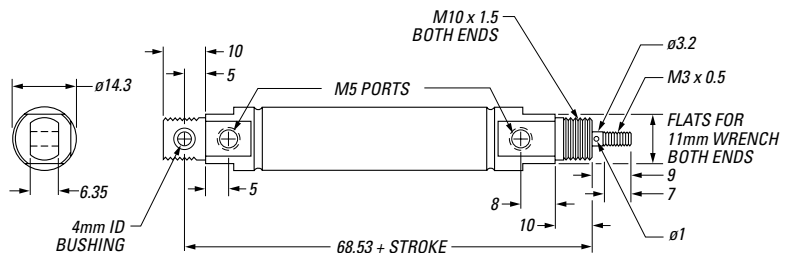

RESET SPRING FORCE FOR SINGLE ACTING UNITS (lbs.)

Stroke	12.5	25.0	37.5
Rod Extended	0.8	0.8	0.8
Rod Retracted	0.5	0.4	0.2

Part #: M9XD...N
STROKE

Air extend, spring return

Strokes: 12.5–25.0–37.5

Front stud mount

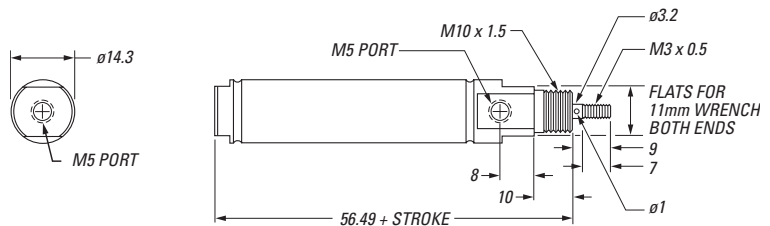

Model M16

Bore Size

15.9 mm

Pressure Range

< 0.0015 to 0.7 MPa

Force Factors

Factor times pressure (MPa) equals output force (newtons)

- Rear side 198
- Rod side 178

Friction Under Pressure

Typically 1%–2% of load in all models

Temperature Range

-55° Celsius to +150° Celsius
(-67° F to +302° F)

Note: For applications operating below -20° C, it is necessary to add “-ET” to the part number. For example: Model M16D25.0N-ET

Weight of piston/rod assembly (grams)

Single rod end models
16 + (0.142 x Stroke)

Double rod end models
28.48 + (0.315 x Stroke)

Weight (max.) of complete unit (grams)

Single rod end models
64.6 + (0.622 x Stroke)

Double rod end models
80.45 + (0.854 x Stroke)

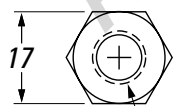

M10 x 1.5



Mounting nut included for all units

DOUBLE ACTING UNITS



Part #: M16D...U
STROKE

Strokes:

12.5–25.0–37.5–50.0–75.0–
100.0–125.0–150.0–175.0–
200.0–225.0–250.0–275.0–300.0

Universal mount includes:

- Rear pivot mount
- Front, rear stud mount

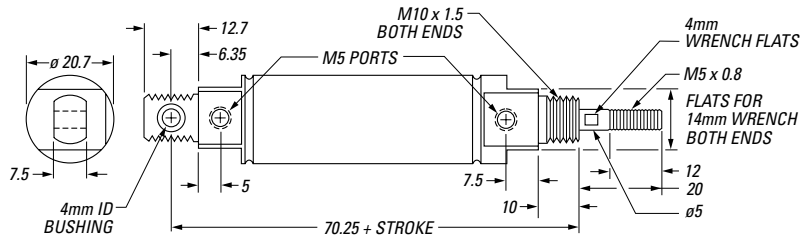

Part #: M16D...N
STROKE

Strokes:

12.5–25.0–37.5–50.0–75.0–
100.0–125.0–150.0–175.0–
200.0–225.0–250.0–275.0–300.0

Front stud mount

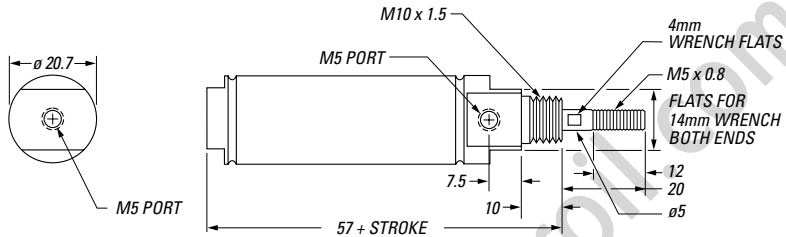

Part #: M16D...S
STROKE

Strokes:

12.5–25.0–37.5–50.0–75.0–
100.0–125.0–150.0–175.0–
200.0–225.0–250.0–275.0–300.0

Front, rear stud mount

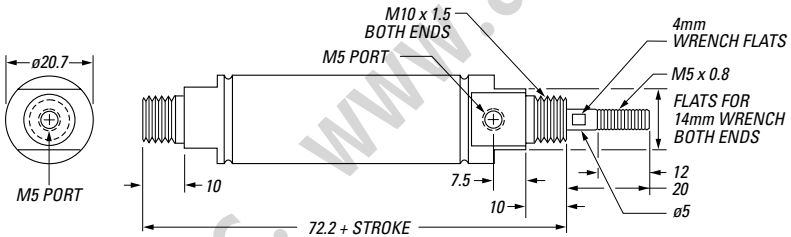

Part #: M16D...D
STROKE

Strokes:

12.5–25.0–37.5–50.0–75.0–
100.0–125.0–150.0–175.0–
200.0–225.0–250.0–275.0–300.0

Double rod end

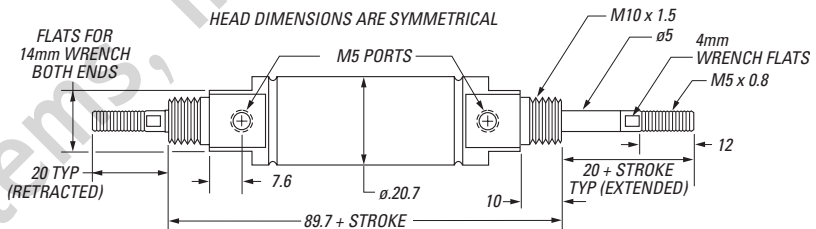

Part #: M16XD...U
STROKE

Air extend, spring return

Strokes: 12.5–25.0–37.5–50.0

Universal mount includes:

- Rear pivot mount
- Front, rear stud mount

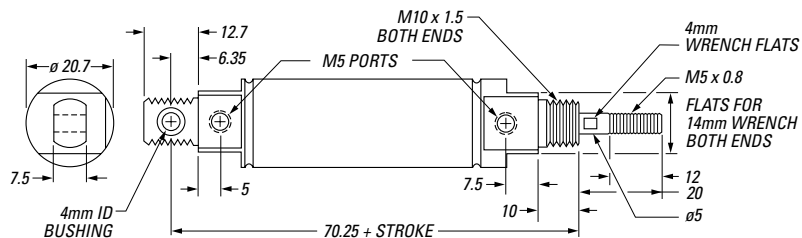

Part #: M16XD...N
STROKE

Air extend, spring return

Strokes: 12.5–25.0–37.5–50.0

Front stud mount

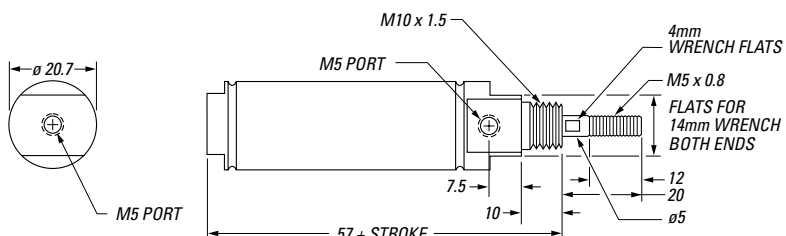

RESET SPRING FORCE FOR SINGLE ACTING UNITS (newtons)

Stroke	12.5	25.0	37.5	50.0
Rod Extended	1.1	1.1	1.1	1.1
Rod Retracted	1.0	0.9	0.8	0.7

Model M24

Bore Size

24.0 mm

Pressure Range

< 0.0015 to 0.7 MPa

Force Factors

Factor times pressure (MPa) equals output force (newtons)

- Rear side 452.5
- Rod side 420.8

Friction Under Pressure

Typically 1%–2% of load in all models

Temperature Range

-55° Celsius to +150° Celsius
(-67° F to +302° F)

Note: For applications operating below -20° C, it is necessary to add “-ET” to the part number. For example: Model M24D25.0N-ET

Weight of piston/rod assembly (grams)

Single rod end models
41.4 + (0.254 x Stroke)

Double rod end models
74.28 + (0.509 x Stroke)

Weight (max.) of complete unit (grams)

Single rod end models
157.18 + (1.225 x Stroke)

Double rod end models
204.9 + (1.480 x Stroke)

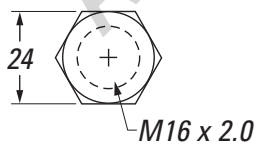

Mounting nut included for all units

DOUBLE ACTING UNITS



SINGLE ACTING UNITS

Part #: M24D_{STROKE}...U

Strokes:

- 12.5–25.0–37.5–50.0–75.0–
- 100.0–125.0–150.0–175.0–
- 200.0–225.0–250.0–275.0–300.0

Universal mount includes:

- Rear pivot mount
- Front, rear stud mount

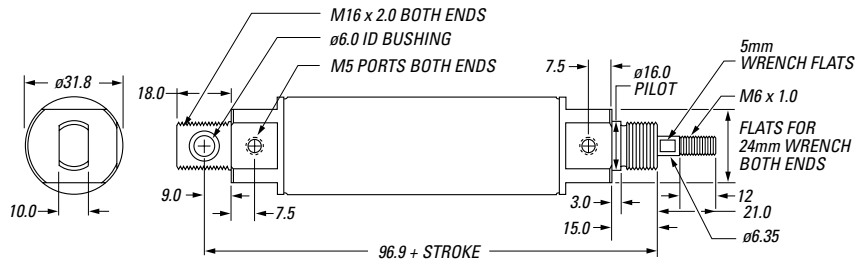

Part #: M24D_{STROKE}...N

Strokes:

- 12.5–25.0–37.5–50.0–75.0–
- 100.0–125.0–150.0–175.0–
- 200.0–225.0–250.0–275.0–300.0

Front stud mount

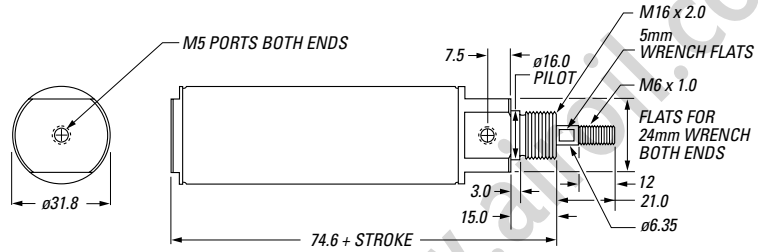

Part #: M24D_{STROKE}...D

Strokes:

- 12.5–25.0–37.5–50.0–75.0–
- 100.0–125.0–150.0–175.0–
- 200.0–225.0–250.0–275.0

Double rod end

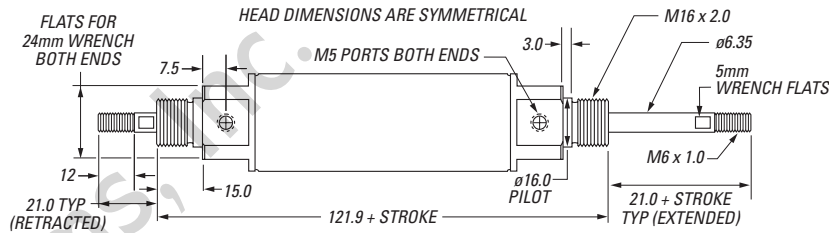

Part #: M24XD_{STROKE}...U

Air extend, spring return

Strokes: 12.5–25.0–37.5–50.0

Universal mount includes:

- Rear pivot mount
- Front, rear stud mount

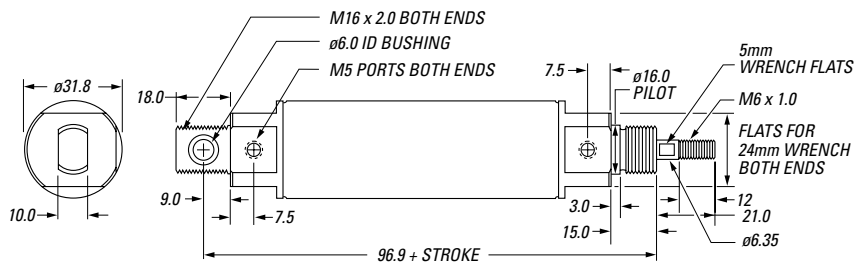

Part #: M24XD_{STROKE}...N

Air extend, spring return

Strokes: 12.5–25.0–37.5–50.0

Front stud mount

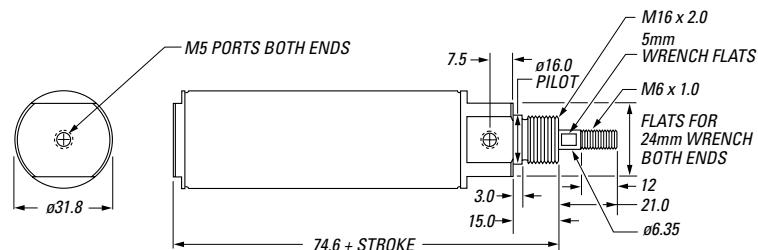

RESET SPRING FORCE FOR SINGLE ACTING UNITS (lbs.)

Stroke	12.5	25.0	37.5	50.0
Rod Extended	1.44	1.44	1.44	1.44
Rod Retracted	1.34	1.26	1.17	1.09

Model M32

Bore Size

32.5 mm

Pressure Range

< 0.0035 to 0.7 MPa

Force Factors

Factor times pressure (MPa) equals output force (newtons)

- Rear side 830
- Rod side 751

Friction Under Pressure

Typically 1%–2% of load in all models

Temperature Range

-55° Celsius to +150° Celsius
(-67° F to +302° F)

Note: For applications operating below -20° C, it is necessary to add “-ET” to the part number.
For example: Model M32D25.0N-ET

Weight (grams)

Piston/rod assembly only
82.6 + (0.56 x Stroke)

Complete unit (max.)
616 + (3.66 x Stroke)

Part #: M32D...U
STROKE

Strokes:

12.5–25.0–50.0–75.0–100.0

Rear pivot mount

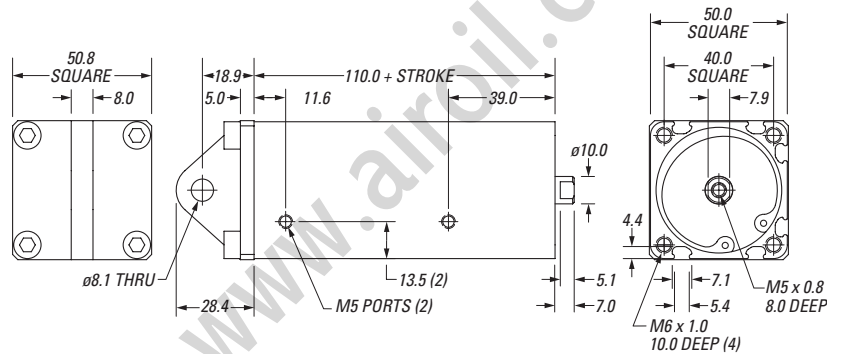

Part #: M32D...N
STROKE

Strokes:

12.5–25.0–50.0–75.0–100.0

Front/rear mount

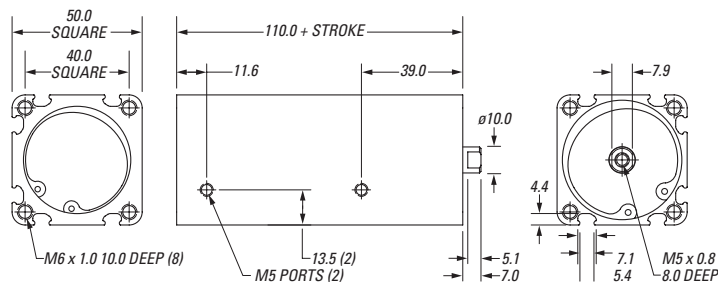

DOUBLE ACTING UNITS

Air-Oil Systems, Inc.

The company behind Airpel is a company you probably already know.

If you've ever needed an air dashpot or shock absorber, you've probably heard of Airpot Corporation.

For over 35 years, we've been the world's leading manufacturer of precision air-damping dashpots.

Before Airpot® dashpots were considered unpredictable band-aids for the treatment of motion control problems.

Today, just the opposite is true. The precision, reliability and smoothness of Airpot air dashpots and shock absorbers have gained the respect of the world's major producers of semiconductor manufacturing equipment, medical analyzers, and test and measurement equipment.

So it should come as no surprise that Airpot is the company behind Airpel. A company recognized and respected for its technical expertise, its devotion to quality,

and its responsiveness to customers.

But just to give you an extra measure of assurance, we back up our quality and service with a solid warranty.

For two full years following the date of manufacture, we will provide free replacement to the original purchaser of any properly implemented unit which is found to be defective or does not meet published or otherwise agreed-upon specifications.

Would you like to know more about our products? Visit our web site at www.airpot.com for an up-to-the minute catalog and to obtain CAD files; e-mail us at service@airpot.com; or write Airpel Division, Airpot Corporation, 35 Lois Street, Norwalk, Connecticut 06851. Or feel free to call us at 1-800-848-7681.

The Airpel Warranty

Airpot will replace or refund your full purchase price, at its option, if there is a defect in materials or workmanship of the Airpel Air Cylinder within two (2) years of purchase, assuming use in accordance with Airpot's specifications. Please refer to your purchase order acknowledgement for the exact terms and limitations of this warranty.

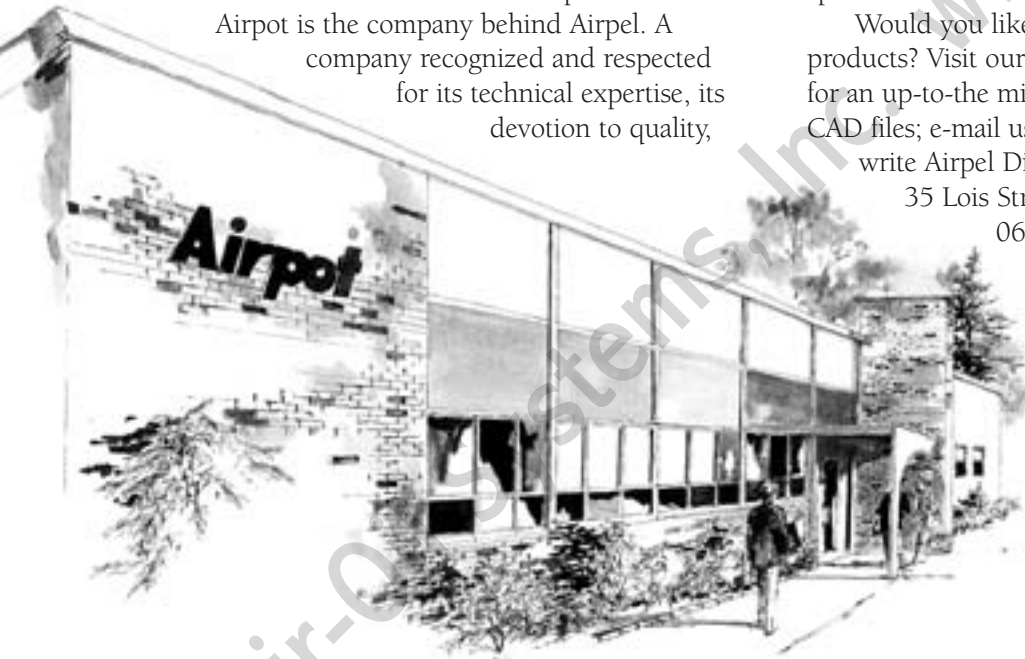

Airpot Corporation, located in Norwalk, Connecticut.

Airpel®

The Anti-Stiction® Air Cylinder.

H

ere are some of the other precision motion control products we make.

DASPOTS

Instrument quality air damping reduces velocity, vibration and oscillation.

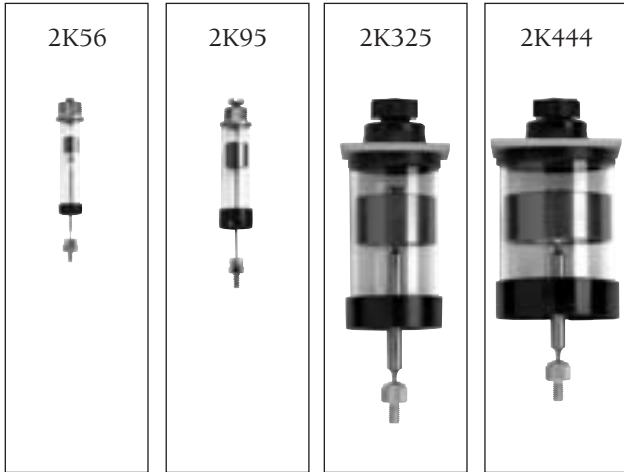

SNUBBERS

Precise shock absorption for light loads.



ACTUATORS

Anti-Stiction and ultra-low friction for sensitive motion.

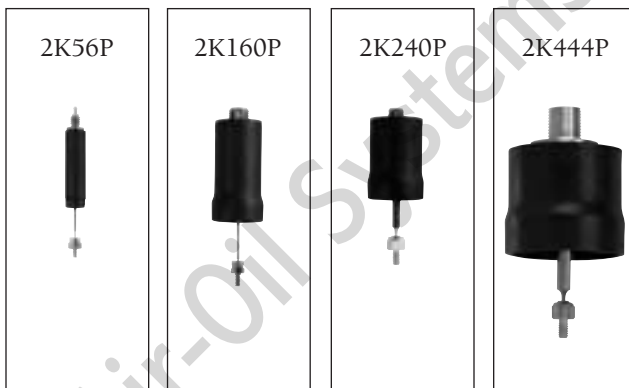

PISTON-CYLINDER SETS

Ultra-low friction components for your own custom design.



Learn more about our products at www.airpot.com

airpel.com

Airpel Division ■ Airpot Corporation ■ 35 Lois Street
Norwalk, CT 06851 ■ 1-800-848-7681 ■ Fax: 203-849-0539
E-mail: service@airpot.com ■ www.airpot.com

Airpel[®]
The Anti-Stiction[®] Air Cylinder.