

PCON

PCON-SE Controller Serial Communication Type

Operation Manual First Edition

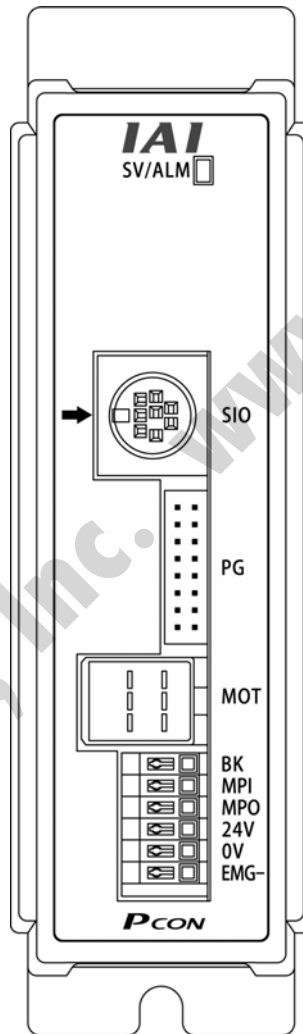

1. Models of Teaching Pendants and PC Software

New functions have been added to the whole PCON Controller Series.

Since the communication protocol is accordingly changed to the general Modbus method (compatible), the PC software and teaching pendants used in conventional RCP2 controllers are not compatible.

When using this controller, prepare the following models:

	Model	Remark
PC software (with RS232C-compatible cables)	RCM-101-MW	Can also be connected to conventional RCP2 controllers
PC software (with USB-compatible communication cables)	RCM-101-USB	
Teaching pendant	RCM-T	
Simple teaching pendant	RCM-E	
Data setter	RCM-P	

2. Recommendation for Backing Up Latest Data

This controller uses nonvolatile memory to store the position table and parameters. Normally the memory will retain the stored data even after the power is disconnected. However, the data may be lost if the nonvolatile memory becomes faulty.

We strongly recommend that the latest position table and parameter data be backed up so that the data can be restored quickly when the controller must be replaced for any other reason.





The data can be backed up using the following methods:



- [1] Save to a storage medium such as a hard disk using PC software.
- [2] Handwrite the position table and parameter table on paper.

Safety Precautions (Be sure to read them before use.)

Please read all of this Operation Manual thoroughly in conjunction with the operation manuals and related documents for all the equipment and peripheral devices connected to this product before installing, operating, and inspecting the product. Such work must be performed by those who have sufficient knowledge about equipment and safety. The precautions described below are designed to help you use the product safely and avoid bodily injury and/or property damage.

Directions in this Operation Manual are classified as “Danger,” “Warning,” “Caution” and “Note” according to the degree of risk.

 Danger	Failure to observe the instruction will result in an imminent danger leading to death or serious injury.
 Warning	Failure to observe the instruction may result in death or serious injury.
 Caution	Failure to observe the instruction may result in injury or property damage.
 Note	The user should take heed of this information to ensure the proper use of the product, although failure to do so may not result in injury.

Failure to observe the instructions even classified as  **Caution** or  **Note** may cause grave consequences according to the circumstances. All the instructions have important descriptions. Please read them thoroughly and handle the product with sufficient caution.

Be sure to keep this Operation Manual and related documents carefully in a convenient place easily accessible whenever necessary and deliver them to end users.

Danger

[General]

- Do not use this product for the following applications:

1. Medical equipment used to maintain, control or otherwise affect human life or physical health
2. Mechanisms and machinery designed for the purpose of moving or transporting people
3. Important safety parts of machinery

This product has not been planned or designed for applications requiring high levels of safety. Use of this product in such applications may jeopardize the safety of human life. The warranty covers only the product as it is delivered.

[Installation]

- Do not use this product in a place exposed to ignitable, inflammable or explosive substances. The product may ignite, burn or explode.
- Avoid using the product in a place where the main unit or controller may come in contact with water or oil droplets.
- Never cut and/or reconnect the cables supplied with the product for the purpose of extending or shortening the cable length. Doing so may result in fire.

[Operation]

- Do not pour water onto the product. Spraying water over the product, washing it with water or using it in water may cause the product to malfunction, resulting in injury, electric shock, fire, etc.

[Maintenance, Inspection, Repair]

- Never modify the product. Unauthorized modification may cause the product to malfunction, resulting in injury, electric shock, fire, etc.
- Do not disassemble and reassemble the product. Doing so may result in injury, electric shock, fire, etc.

Warning

[General]

- Do not use the product outside the specifications. Using the product outside the specifications may cause it to fail, stop functioning or sustain damage. It may also significantly reduce the service life of the product. In particular, observe the maximum loading capacity and speed.

[Installation]

- If the machine stops in the case of system problem such as emergency stop or power failure, design a safety circuit or other device that will prevent equipment damage or injury.
- Be sure to provide Class D grounding for the controller and actuator (formerly Class C grounding: Grounding resistance at 100Ω or less). Leakage current may cause electric shock or malfunction.
- Before supplying power to and operating the product, always check the operation area of the equipment to ensure safety. Supplying power to the product carelessly may cause electric shock or injury due to contact with the moving parts.
- Wire the product correctly by referring to the Operation Manual. Securely connect the cables and connectors so that they will not be disconnected or come loose. Failure to do so may cause the product to malfunction or cause fire.

[Operation]

- Do not touch the terminal block or various switches while the power is supplied to the product. Failure to observe this instruction may result in electric shock or malfunction.
- Before operating the moving parts of the product by hand (for the purpose of manual positioning, etc.), confirm that the servo is turned off (using the teaching pendant). Failure to observe this instruction may result in injury.
- Do not scratch the cables. Scratching, forcibly bending, pulling, winding, crushing with a heavy object or pinching a cable may cause it to leak current or lose continuity, resulting in fire, electric shock, malfunction, etc.
- Turn off the power to the product in the event of power failure. Failure to do so may cause the product to suddenly start moving when the power is restored, thus resulting in injury or product damage.
- If the product is generating abnormal heat, smoke or a strange smell, turn off the power immediately. Continuing to use the product may result in product damage or fire.
- If any of the internal protective devices (alarms) of the product has actuated, turn off the power immediately. Continuing to use the product may result in product damage or injury due to malfunction. Once the power supply is cut off, investigate and remove the cause and then turn on the power again.

- If the LEDs on the product do not illuminate after turning on the power, turn off the power immediately. The protective device (fuse etc.) on the live side may remain active. Request repair to the IAI sales office from which you purchased the product.

[Maintenance, Inspection, Repair]

- Before conducting maintenance/inspection, parts replacement or other operations to the product, completely shut down the power supply. At this time, take the following measures:
 1. Display a sign that reads, "WORK IN PROGRESS. DO NOT TURN ON POWER." at a conspicuous place, in order to prevent a person other than the operator from accidentally turning on the power.
 2. When two or more operators are to perform maintenance/inspection together, always call out every time the power is turned on/off or an axis is moved in order to ensure safety.

[Disposal]

- Do not throw the product into fire. The product may burst or generate toxic gases.



Caution

[Installation]

- Do not use the product under direct sunlight (UV rays), in a place exposed to dust, salt or iron powder, in a humid place, or in an atmosphere of organic solvent, phosphate-ester machine oil, etc. The product may lose its function over a short period of time, or exhibit a sudden drop in performance or its service life may be significantly reduced. Malfunctioning of the product may occur.
- Do not use the product in an atmosphere of corrosive gases (sulfuric acid or hydrochloric acid), etc. Rust may form and reduce the structural strength.
- When using the product in any of the places specified below, provide a sufficient shield. Failure to do so may result in malfunction.
 1. Place where large current or high magnetic field is present
 2. Place where welding or other operations are performed that cause arc discharge
 3. Place subject to electrostatic noise
 4. Place with potential exposure to radiation
- Do not install the product in a place subject to large vibration or impact (4.9 m/s^2 or more). Doing so may result in the malfunctioning of the product.
- Provide an emergency-stop device in a readily accessible position so the device can be actuated immediately upon occurrence of a dangerous situation during operation. Lack of such device in an appropriate position may result in injury.
- Provide sufficient maintenance space when installing the product. Routine inspection and maintenance cannot be performed without sufficient space, which will eventually cause the equipment to stop or the product to sustain damage.
- Always use IAI's genuine cables for connection between the controller and the actuator. Also, use IAI's genuine products for the key component units such as the actuator, controller and teaching pendant.
- Before installing or adjusting the product or performing other operations to the product, display a sign that reads, "WORK IN PROGRESS. DO NOT TURN ON POWER." If the power is turned on inadvertently, injury may result due to electric shock or sudden activation of an actuator.

[Operation]

- Turn on the power to individual equipment one by one, starting from the equipment at the highest level in the system hierarchy. Failure to do so may cause the product to start suddenly, resulting in injury or product damage.
- Do not insert a finger or object in the openings in the product. It may cause fire, electric shock or injury.

[Maintenance, Inspection, Repair]

- Do not touch the terminals when performing an insulation resistance test. Electric shock may result. (Do not perform any withstand voltage test, since the product uses DC voltage.)

! Note

[Installation]

- Do not place objects around the controller that will block airflows. Insufficient ventilation may damage the controller.
- Do not configure a control circuit that will cause work to drop in case of power failure. Configure a control circuit that will prevent the table or work from dropping when the power to the machine is cut off or an emergency stop is actuated.

[Installation, Operation, Maintenance]

- When handling the product, wear protective gloves, protective goggles, safety shoes or other necessary gear to ensure safety.

[Disposal]

- When the product becomes no longer usable or necessary, dispose of it properly as an industrial waste.

Other

- IAI shall not be liable whatsoever for any loss or damage arising from a failure to observe the items specified in "Safety Precautions."

Table of Contents

1.	Overview.....	1
1.1	Introduction	1
1.2	Main Features and Functions.....	2
1.3	Control Differences with Air Cylinder.....	3
1.4	Model Number	5
1.5	System Configuration.....	6
1.6	Procedure from Unpacking to Trial Run Adjustment.....	8
1.7	Warranty Period and Scope of Warranty	10
2.	Specifications.....	11
2.1	Basic Specifications	11
2.2	Name and Function of Each Part of the Controller.....	12
2.3	External dimensions.....	14
2.4	SIO Converter (Option)	15
3.	Installation and Wiring.....	17
3.1	Installation Environment.....	17
3.2	Power Supply	17
3.3	Noise Elimination and Grounding.....	17
3.4	Heat Radiation and Installation	19
3.5	External Connection Diagram	20
3.6	Wiring the Power Supply.....	21
3.7	Wiring the Brake Release Switch to Forcibly Release the Brake	21
3.8	Wiring the Emergency Stop Circuit	22
3.8.1	Drive Signal Shutdown (Standard)	22
	(1) When the SIO converter is used	22
	(2) When the gateway unit is used.....	23
3.8.2	Cutting off the Motor Drive Power Supply	24
	(1) When the SIO converter is used	24
	(2) When the gateway unit is used	25
3.9	Connecting the Actuator.....	26
3.9.1	Motor Relay Cable	26
3.9.2	Encoder Relay Cable	27
3.10	Connecting the SIO Communication.....	28
3.10.1	Connecting the RS232C Serial Communication	28
	(1) Basic information	28
	(2) Connecting the multiple axes.....	29
3.10.2	Connection to Field Network.....	32
4.	Description of Operating Functions.....	33
4.1	Description of Position Table.....	34
4.2	Notes on Robo Gripper	38
4.3	Setting Data in Numeric Specification Mode	40
4.4	Description of Functions.....	40
4.4.1	Control Signals, Control Data.....	42
4.4.2	Timing after Power ON.....	48
4.4.3	Home Return Operation.....	50
4.4.4	Positioning Operation.....	52
4.4.5	Push & Hold Operation	56
4.4.6	Pause.....	64

4.4.7	Speed Change during Movement.....	65
4.4.8	Operation at Different Acceleration and Deceleration Settings	67
4.4.9	Zone Signal.....	68
4.4.10	Pitch Feeding by Relative Coordinate Specification.....	69
4.4.11	Power Saving Method in the Standby Position.....	73
5.	Parameter Settings	74
5.1	Parameter Table.....	74
5.2	Parameter Settings	75
5.2.1	Parameters Relating to the Actuator Stroke Range.....	75
5.2.2	Parameters Relating to the Actuator Operating Characteristics.....	77
5.2.3	Parameters Relating to the External Interface	82
5.2.4	Servo Gain Adjustment	83
6.	Troubleshooting	85
6.1	Action to Be Taken upon Occurrence of Problem.....	85
6.2	Alarm Level Classification	86
6.3	Alarm Description and Cause/Action	87
6.4	Messages Displayed during Operation Using the Teaching Pendant or PC Software.....	92
6.5	Specific Problems	94
7.	Operation Examples	98
* Appendix	99

1. Overview

1.1 Introduction

The PCON Series controllers are specifically designed for the RCP2 actuator, and adopt new functions to further enhance convenience and safety by reducing the size and cost while following the functions of the RCP2 controller. In addition, the power-saving considered function has been adopted, with awareness of energy conservation raised.

Of the PCON Series controllers, this product is of the type which is operated in the position number specification or numeric specification mode via serial communication.

The serial communication system can support the following two patterns as the serial communication system:

- [1] The product can be used under the field network (DeviceNet, CC-Link, Profibus) such as a host PLC as the gateway unit.
- [2] RS-232C serial communication is available with a PC or PLC using the SIO converter.

When actually starting the equipment or a failure occurs, refer to the operating manuals of the actuator, teaching pendant, PC software and other devices in addition to this document.

This Operation Manual does not completely cover all items other than normal operations or unexpected phenomena such as complicated signal changes by critical timing. Therefore, interpret any items not covered by this manual as "impossible to do" in principle.

* We have made every effort to ensure accuracy of the information provided in this manual. Should you find an error, however, or if you have any comments, please contact IAI.

Keep this manual in a convenient place so it can be reread when necessary.

1.2 Main Features and Functions

- (1) Control signals are input/output via serial communication RS485 (compatible with Modbus protocol).
- (2) Positioning points: 64
- (3) Setting of zone output boundary values
The zone output boundary values were previously fixedly set with parameters. Convenience has been enhanced since they can now be set in the position table (only in the position number specification mode).
It can be used for the prevention of interference with peripheral equipment or reduction of tact time.
- (4) Separate setting of acceleration and deceleration (only in position no. specification mode)
The acceleration and deceleration can separately be set in the position table.
When you do not want to give impact or vibration during stop due to the material or shape of transferred work, gradual deceleration becomes available by reducing deceleration only.
- (5) Limitation of movement speed during trial run adjustment
The movement speed during trial run adjustment can be limited in terms of ensuring safety.
- (6) Power-saving measures
The pulse motor generally tends to have more holding current at standstill compared with the AC servo motor. Therefore, the power saving mode can be used for applications with long standby time.

1.3 Control Differences with Air Cylinder

Main differences between the air cylinder and this controller are briefly described below for customers who previously used an air cylinder and will use a power cylinder for the first time.

Perform appropriate control by referring to this table.

Item	Air Cylinder	PCON								
Drive system	Air pressure supplied via electromagnetic valve control	Ball screw and timing belt driven by pulse motor								
Target position setting	Mechanical stopper (including shock absorber)	<p>[1] Position number specification mode Desired coordinates are entered in the [Position] field of the position table. The coordinates can be typed in from the number keys on the PC keyboard or on the teaching pendant, or set directly by moving the actuator to the target position. Example: 400mm stroke entry example</p> <table border="1"> <thead> <tr> <th>Position No.</th> <th>Position</th> </tr> </thead> <tbody> <tr> <td>0</td> <td>5 (mm)</td> </tr> <tr> <td>1</td> <td>400 (mm)</td> </tr> <tr> <td>2</td> <td>200 (mm)</td> </tr> </tbody> </table> <p>[2] Numeric specification mode: Direct numeric specification</p>	Position No.	Position	0	5 (mm)	1	400 (mm)	2	200 (mm)
Position No.	Position									
0	5 (mm)									
1	400 (mm)									
2	200 (mm)									
Target position detection	An external detection sensor, such as a reed switch, is installed.	<p>Determined based on the internal coordinates provided by the position information from the position detector (encoder). Accordingly, an external detection sensor is not required.</p>								
Speed setting	Adjusted by a speed controller.	<p>[1] A desired feed speed is entered in the [Speed] field of the position table (unit: mm/sec). Note that the rated speed is automatically set as the initial value.</p> <p>[2] Direct numeric specification</p>								
Acceleration/deceleration setting	Determined in accordance with the load, supplied air volume, as well as the performance of the speed controller and electromagnetic valve.	<p>[1] A desired acceleration/deceleration is entered in the [Acceleration/deceleration] field of the position table (minimum set unit: 0.01G) Reference: 1G = Gravitational acceleration Note that the rated acceleration/deceleration is automatically set as the initial value.</p> <p>[2] Direct numeric specification Since the acceleration/deceleration can be set in fine steps, a gradual acceleration/deceleration curve can be programmed.</p> <p>A sharp curve is marked for a large numeric value while a gradual curve is marked for a small numeric value.</p>								

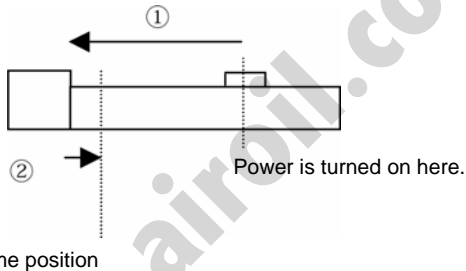
Item	Air Cylinder	PCON
Position check upon power ON	Determined by an external detection sensor, such as a reed switch.	<p>Immediately after the power is turned on, the controller cannot identify the current position because the mechanical coordinates have been lost. Therefore, it is required to establish coordinate values by always issuing the home return command first after the power has been input.</p>  <p>[1] The actuator moves at the home return speed toward the mechanical end on the motor side.</p> <p>[2] The actuator hits the mechanical end and turns back, and then stops temporarily at the home position.</p> <p>(Note) Pay attention not to allow any obstacle in the travel path of the actuator during home return.</p>

PCON

1.4 Model Number

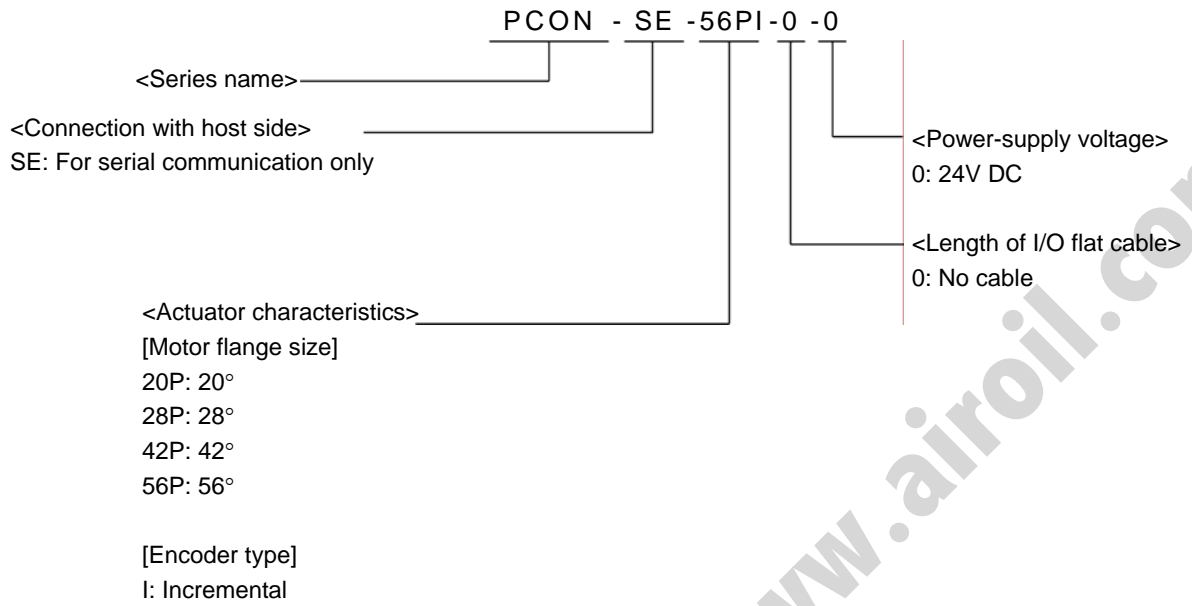

Air-Oil Systems, Inc. www.airoil.com

1.5 System Configuration

(1) When the gateway unit is used (supporting field network)

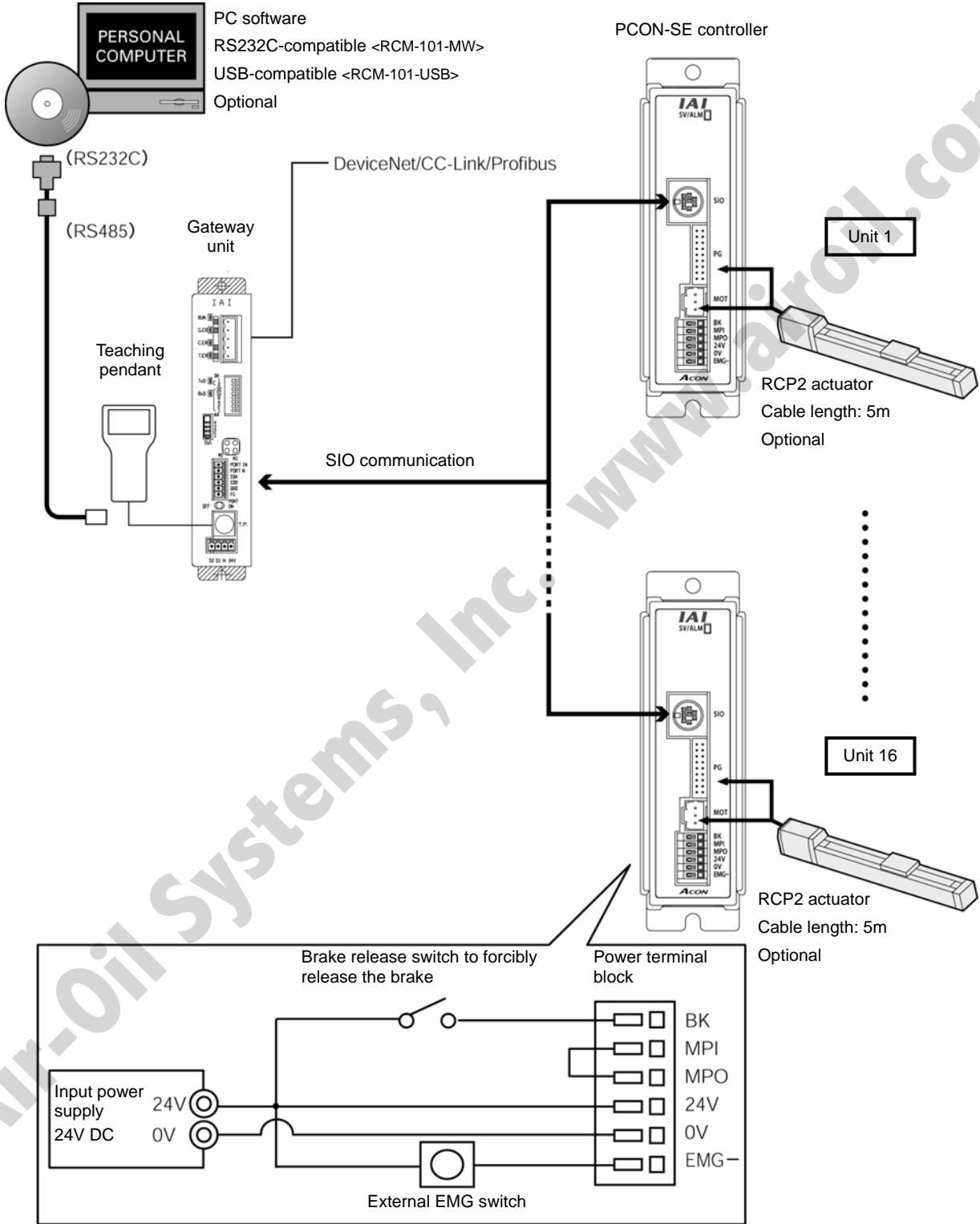

- ⚠ Caution: (1) If the actuator is not equipped with a brake, it is not required to connect the BK terminal.
(2) Make the 0V of the gateway unit power supply and PCON-SE power supply in common.

(2) When the SIO converter is used (RS232C serial communication)

Connect the teaching pendant, PC or PLC using the SIO converter (RS232C/RS485 conversion) as shown below.

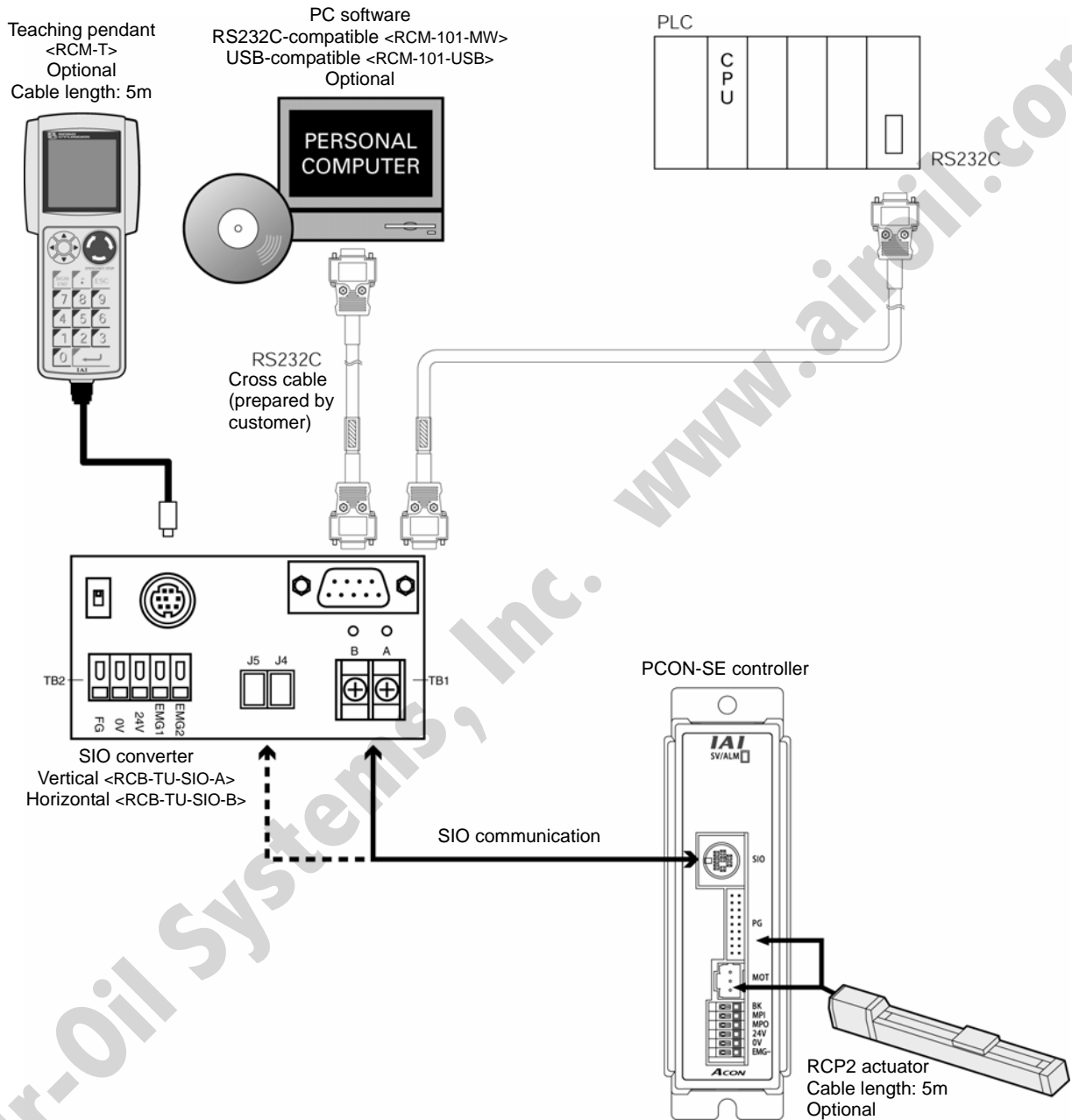

Caution: Do not connect the teaching pendant and PC at the same time.
If the both are connected at the same time, a communication error (message level) will occur.

1.6 Procedure from Unpacking to Trial Run Adjustment

When using this product for the first time, pursue work while paying attention to avoid check omission and incorrect wiring by referring to the procedure below.

1. Check of Packed Items

Should there be any incorrect model or insufficient item, contact your dealer.

- Controller PCON-SE
- Actuator
- Communication cable
- Motor cable CB-RCP2-MA***
- Encoder cable CB-RCP2-PA***

- Operation Manual

<Option>

- Teaching pendant
 - RCM-T (standard)
 - RCM-E (simple)
 - RCM-P (data setting)
- PC software
 - RS232C-compatible <RCM-101-MW>
 - USB-compatible <RCM-101-USB>
 - (including provided cables)

2. Installation

- [1] After fixing the actuator, install the robot hand. → Refer to the operation manual on the applicable actuator.
- [2] Install the controller. → 3. Installation and Wiring

3. Wiring and Connection

- Wiring of the 24V power supply
- Wiring of the brake release switch to forcibly release the brake (when the actuator is equipped with a brake)
- Earth grounding
- Wiring of the emergency stop circuit and motor drive power supply
- Connection of the motor cable and encoder cable
- Connection of communication cable

4. Power Supply and Alarm Check

After confirming that the emergency stop circuit is not activated, supply the 24V power.

It is normal if at this time, the monitor LED [SV/ALM] on the front of the controller illuminates in orange for the first 2 seconds and then illuminates in green.

If the [SV/ALM] illuminates in red, an alarm will be generated.

After connecting the PC or teaching pendant, check the alarm description and remove the cause by referring to "6. Troubleshooting."

5. Check of Servo ON Condition

Confirm that the slider or rod is not contacting the mechanical end.

If the slider or rod is contacting the mechanical end, move it away in the opposite direction.

If the actuator is equipped with a brake, move the slider/rod after turning ON the brake release switch to forcibly release the brake. At this time, exercise caution not to allow work to drop suddenly due to its own weight. Your hand may be caught by the dropped work or the robot hand or work itself may be damaged.

It is normal if the actuator achieves servo lock and the monitor LED [SV/ALM] on the front of the controller illuminates in green.

6. Safety Speed Setting

The default value of the safety speed is 100 mm/s or less.

Change it if necessary. (Limited to 250 mm/s or less) → 5. Parameter Settings

7. Target Position Setting

Set desired positions in the [Position] field of the position table by using the teaching pendant or PC, or set numeric values directly.

- * If you move the actuator without setting desired positions, the message "No movement data" will be displayed. Determine target positions while fine adjusting the transferred work and robot hand.
- * Once the target positions have been set, default values are automatically set to the other items (speed, acceleration/deceleration, positioning band, etc.).
→ 4.1 Description of Position Table

8. Operational Check of Safety Circuit

Confirm that the drive signal shutdown circuit (or motor drive power shutoff circuit) normally operates.

→ 3. Installation and Wiring

9. Trial Run Adjustment

Input a movement command from PLC for positioning.

At this time, perform the following fine adjustments if necessary:

- If vibration or abnormal sound occurs due to the weight, material or shape of transferred work, reduce the speed, acceleration or deceleration.
- Prevention of interference with peripheral equipment, review of the boundary value of the zone output signal and positioning band to reduce tact time
- Selection of the optimum values for the current-limiting value, evaluation time and push speed during push & hold operation

→ 4.1 Description of Position Table

1.7 Warranty Period and Scope of Warranty

The PCON-SE controller you have purchased has passed IAI's shipping inspection implemented under the strictest standards. The unit is covered by the following warranty:

1. Warranty Period

The warranty period shall be one of the following periods, whichever ends first:

- 18 months after shipment from our factory
- 12 months after delivery to a specified location

2. Scope of Warranty

If an obvious manufacturing defect is found during the above period under an appropriate condition of use, IAI will repair the defect free of charge. Note, however, that the following items are excluded from the scope of warranty:

- Aging such as natural discoloration of coating
- Wear of a consumable part due to use
- Noise or other sensory deviation that does not affect the mechanical function
- Defect caused by inappropriate handling or use by the user
- Defect caused by inappropriate or erroneous maintenance/inspection
- Defect caused by use of a part other than IAI's genuine part
- Defect caused by an alteration or other change not approved by IAI or its agent
- Defect caused by an act of God, accident, fire, etc.

The warranty covers only the product as it has been delivered and shall not cover any losses arising in connection with the delivered product. The defective product must be brought to our factory for repair.

Please carefully read the above conditions of warranty.

2. Specifications

2.1 Basic Specifications

Specification Item		Description
Model		PCON-SE
Number of controlled axes		1 Axis/unit
Supply voltage		24V DC \pm 10%
Supply current		2A max.
Control method		Weak field-magnet vector control (patent pending)
Encoder resolution		800P/rev
Positioning command		Position no. specification, numerical specification, simple direct value/position no. specification
Backup memory		Position table data and parameters are saved in nonvolatile memory. Serial EEPROM can be rewritten 100,000 times.
Position number		Maximum 64 points
LED indicators		SV (green): Servo ON state, ALM (red): Alarm state
Serial communication		RS485 1 channel
Communication protocol		Modbus/RTU, Modbus/ASCII
Encoder interface		Incremental specification conforming to EIA RS-422A/423A
Forcibly releasing of electromagnetic brake		24V applied to BK terminal on terminal block
Cable length		Actuator cable: 20m or less
		Communication cable: Total cable length 100m or less
Insulation strength		500V DC, 10 M Ω
Environment	Operating temperature	0 to 40°C
	Operating humidity	85%RH or less (non-condensing)
	Operating environment	Not subject to corrosive gases
	Storage temperature	-10 to 65°C
	Storage humidity	90%RH or less (non-condensing)
	Vibration resistance	10 to 57 Hz in XYZ directions, Pulsating amplitude: 0.035mm (continuous), 0.075mm (intermittent)
Protection class		Air cooling without blower (IP20)
Weight		128 g or less
External dimensions		35 W \times 129 H \times 68 D mm

2.2 Name and Function of Each Part of the Controller

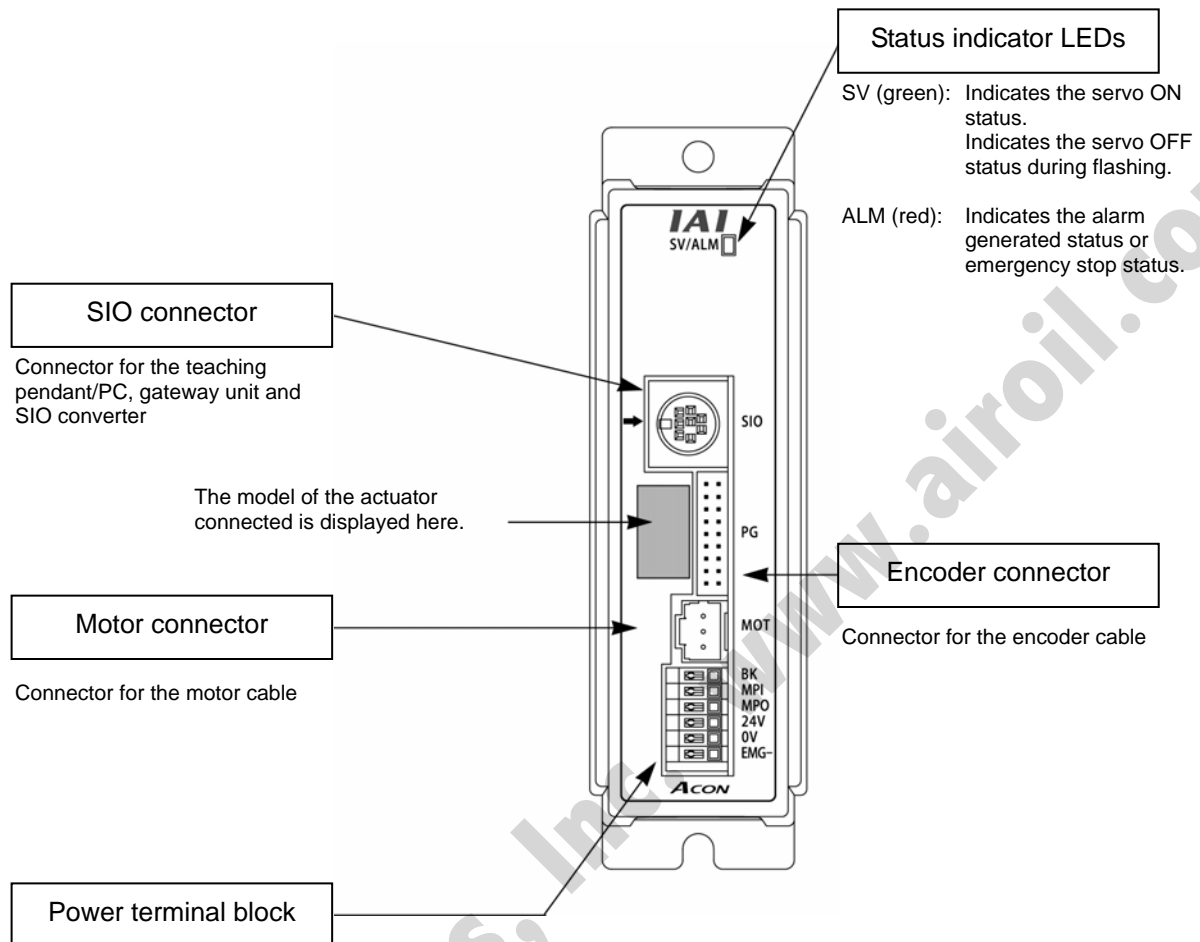

BK	Terminal for connecting the brake release switch to forcibly release the brake when the actuator is used with a brake option. Connect the opposite side of the switch to 24V.
MPI, MPO	A contact for cutting off motor drive power supply with safety category 1 or equivalent considered. MPI and MPO represent the input side and output side of the motor power supply, respectively. (Short these terminals using a jumper wire if not used. The controller is shipped with MPI and MPO shorted.)
24V	Positive side of the 24V DC input power supply
0V	0V side of the 24V DC input power supply
EMG-	Terminal for connecting the emergency stop circuit (motor drive signal shutdown). With the grounding common, connect the opposite side of the emergency stop switch (or contact) to the negative side of the 24V DC input power supply.

■ Notation of the actuator type connected

The type name, ball screw lead length, and stroke of the actuator are indicated. Before connecting cables, confirm that the actuator is an appropriate one.

Notation example:

RA4C	← Indicates the actuator type is RA4C.
L: 5mm	← Indicates the ball screw lead length is 5mm.
ST: 200	← Indicates the stroke is 200mm.

Air-Oil Systems, Inc. www.airoil.com

2.3 External dimensions

An external view and dimensions of the product are shown below.

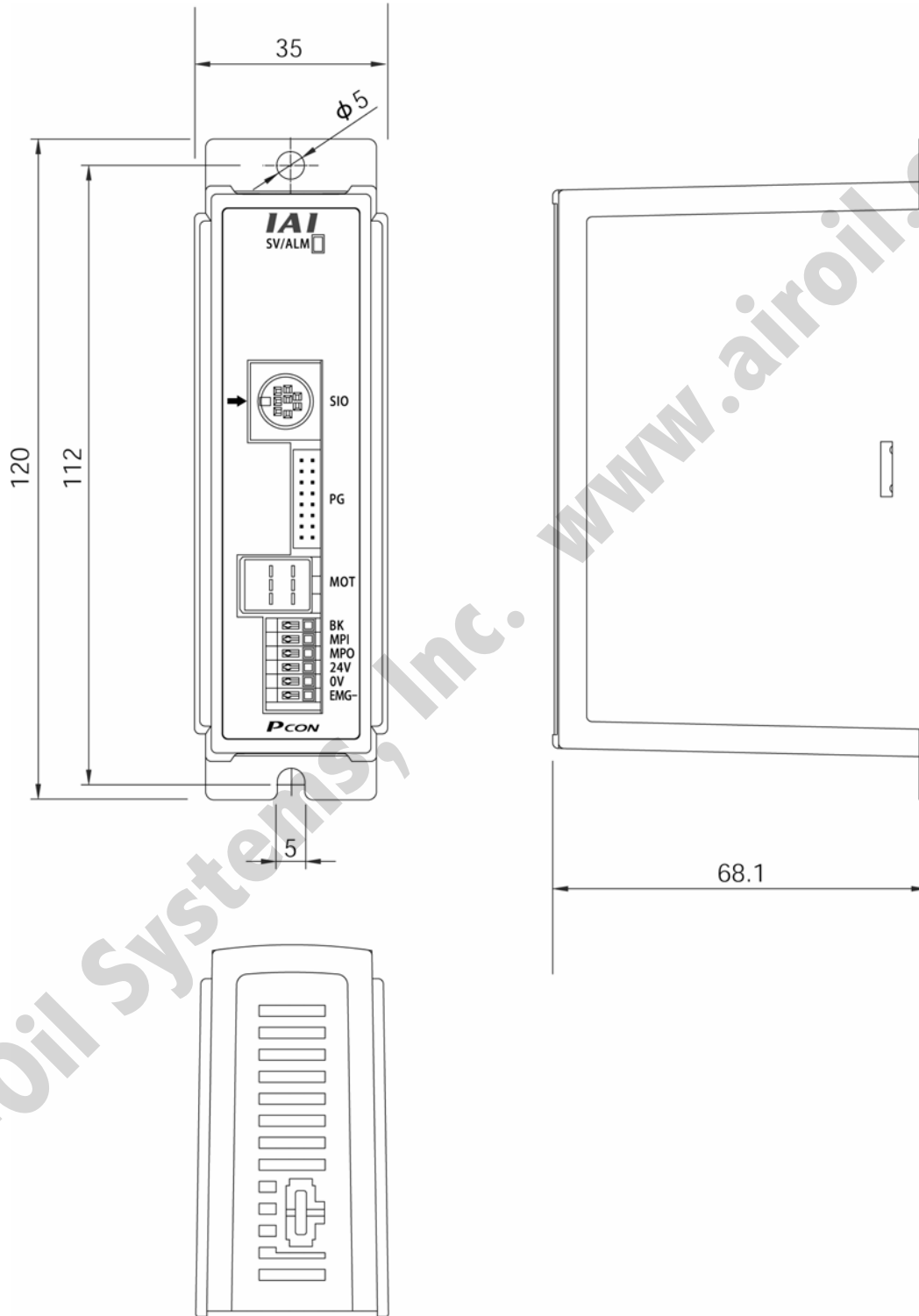

2.4 SIO Converter (Option)

Model: RCB-TU-SIO-A (vertical installation)
RCB-TU-SIO-B (horizontal installation)

This unit is required when the following is applicable:

- [1] Movement operation/parameter editing for all axes when multiple units are used in one piece of equipment

● Description of Functions

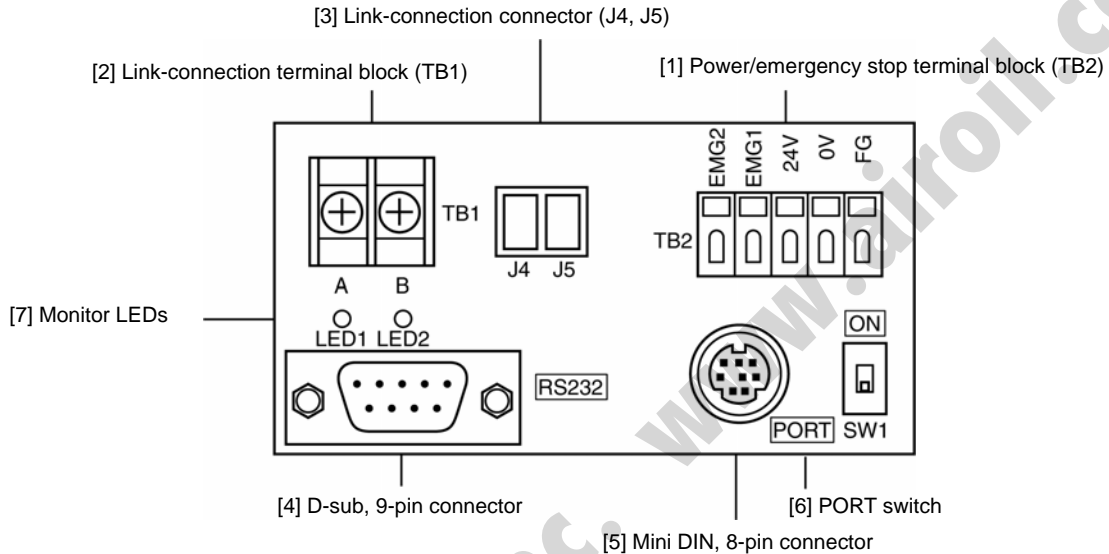

[1] Power/emergency stop terminal block (TB2)

EMG1, EMG2	Provide a contact output for the emergency-stop switch on the teaching pendant (RCM-T/E). EMG1 and EMG2 connect to the emergency-stop switch on the teaching pendant when the PORT switch is ON, or are shorted when the PORT switch is OFF. These terminals comprise an interlock with a safety circuit provided by the user.
24V	Positive side of the 24V power supply (power supply for the teaching pendant and conversion circuit, power consumption: 0.1A or less)
0V	Negative side of the 24V power supply
FG	FG of the 24V power supply

[2] Link-connection terminal block (TB1)

A connection port for linking the controller.

“A” on the left side connects to SGA (line color: orange/red 1) of the relay cable or “A” on the insulated PIO terminal block (TB2).

“B” on the right side connects to SGB (line color: orange/black 1) of the relay cable or “B” on the insulated PIO terminal block (TB2).

(Note) Be sure to use twisted pair wires for the above two connections (SGA/SGB).

[3] Link-connection connector (J4, J5)

A connection port for linking the controller.

The optional link cable (CB-RCB-CTL002) can be connected to this port as it is. However, J4 and J5 allow only two-axis connection. When connecting three or more axes, use the terminal block of [2].

P CON

- [4] D-sub, 9-pin connector
A connection port with the host PC or PLC's communication module.
- [5] Mini DIN, 8-pin connector
A connection port with the teaching pendant.
- [6] PORT switch
A switch for enabling/disabling the teaching pendant.
Set the switch to ON when a teaching pendant is used, or OFF when the teaching pendant is not used.
- [7] Monitor LEDs
LED1: Lit when the controller is transmitting
LED2: Lit when the RS232C is transmitting

(Reference) Connection diagram for RS232C cross cable

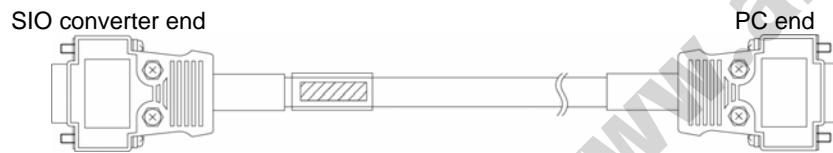

D-sub, 9-pin female connector

D-sub, 9-pin female connector

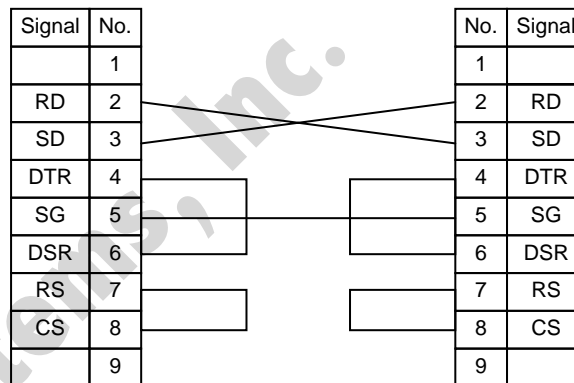

3. Installation and Wiring

Pay sufficient attention to the installation environment of the controller.

3.1 Installation Environment

- (1) When installing and wiring the controller, do not block the cooling ventilation holes. (Insufficient ventilation will not only prevent the controller from demonstrating its full performance, but it may also cause breakdown.)
- (2) Prevent foreign matter from entering the controller through the ventilation holes. Since the enclosure of the controller is not dustproof or waterproof (oilproof), avoid using the controller in a place subject to significant dust, oil mist or splashes of cutting fluid.
- (3) Do not expose the controller to direct sunlight or radiating heat from a large heat source such as a heat treatment furnace.
- (4) Use the controller in an environment free from corrosive or inflammable gases, under a temperature of 0 to 40°C and humidity of 85% or less (non-condensing).
- (5) Use the controller in an environment where it will not receive any external vibration or shock.
- (6) Prevent electrical noise from entering the controller or its cables.

3.2 Power Supply

The power supply specification is 24V DC \pm 10%.

(Supply current: 2A max.)

3.3 Noise Elimination and Grounding

This section explains how to eliminate noise in the use of the controller.

(1) Wiring and power supply

- [1] Provide a dedicated class D grounding using a wire with a size of 2.0 to 5.5 mm² or larger.

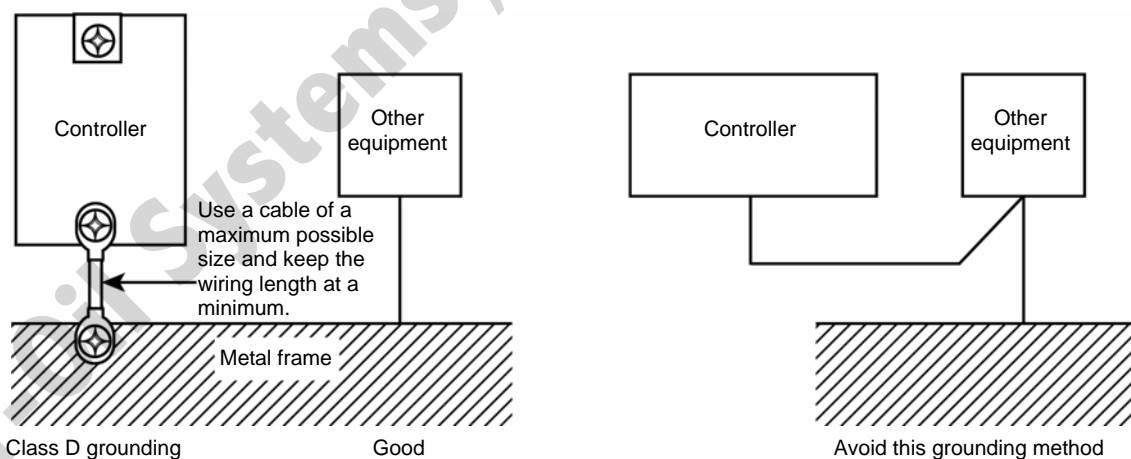

- [2] Precautions regarding wiring method

Use a twisted cable for connection to the 24V DC external power supply.

Separate the controller cables from high-power lines such as a cable connecting to a power circuit. (Do not bundle together the controller cables with high-power lines or place them in the same cable duct.)

When extending the supplied motor cable or encoder cable, consult IAI's Technical Support.

(2) Noise sources and elimination

Among the numerous noise sources, solenoid valves, magnet switches and relays are of particular concern when building a system. Noise from these sources can be eliminated by implementing the measures specified below. When extending the supplied motor cable or encoder cable, consult IAI's Technical Service Division or Sales Engineering Division.

AC solenoid valves, magnet switches and relays

Measure: Install a surge absorber in parallel with the coil.

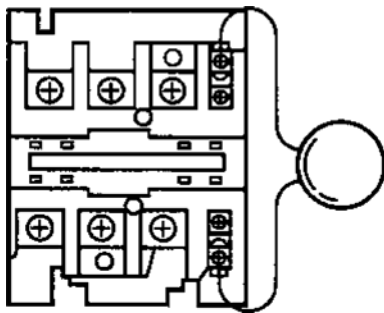

← Point

Install a surge absorber to each coil over a minimum wiring length.
Installing a surge absorber to the terminal block or other part will be less effective because of a longer distance from the coil.

3.4 Heat Radiation and Installation

Design the control panel size, controller layout and cooling method in such a way that the temperature around the controller will not exceed 40°C.

Install the controller vertically on a wall, as shown below. Since cooling is provided by way of natural convection, always observe this installation direction and provide a minimum clearance of 50mm above and below the controller to ensure sufficient natural airflows.

When installing multiple controllers side by side, providing a ventilation fan or fans above the controllers will help maintain a uniform temperature around the controllers.

Keep the front panel of the controller away from the wall (enclosure) by at least 80mm.

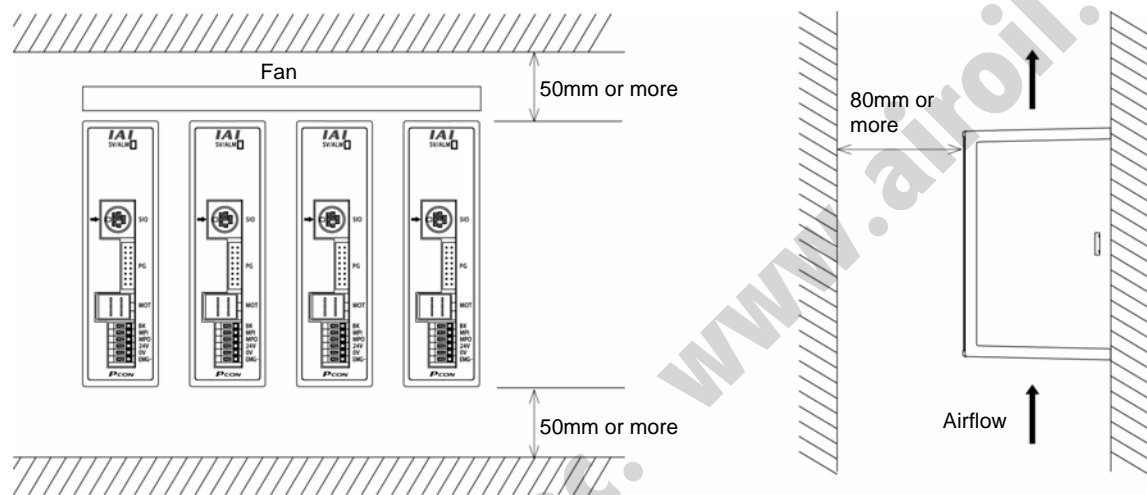

Regardless of whether your system consists of a single controller or multiple controllers, provide sufficient clearance around each controller so that it can be installed/removed easily.

3.5 External Connection Diagram

An example of standard wiring is shown below.

(Note) When encoder relay cables are of the robot cable specification, the line colors will be different, refer to "3.9.2 Encoder Relay Cables."

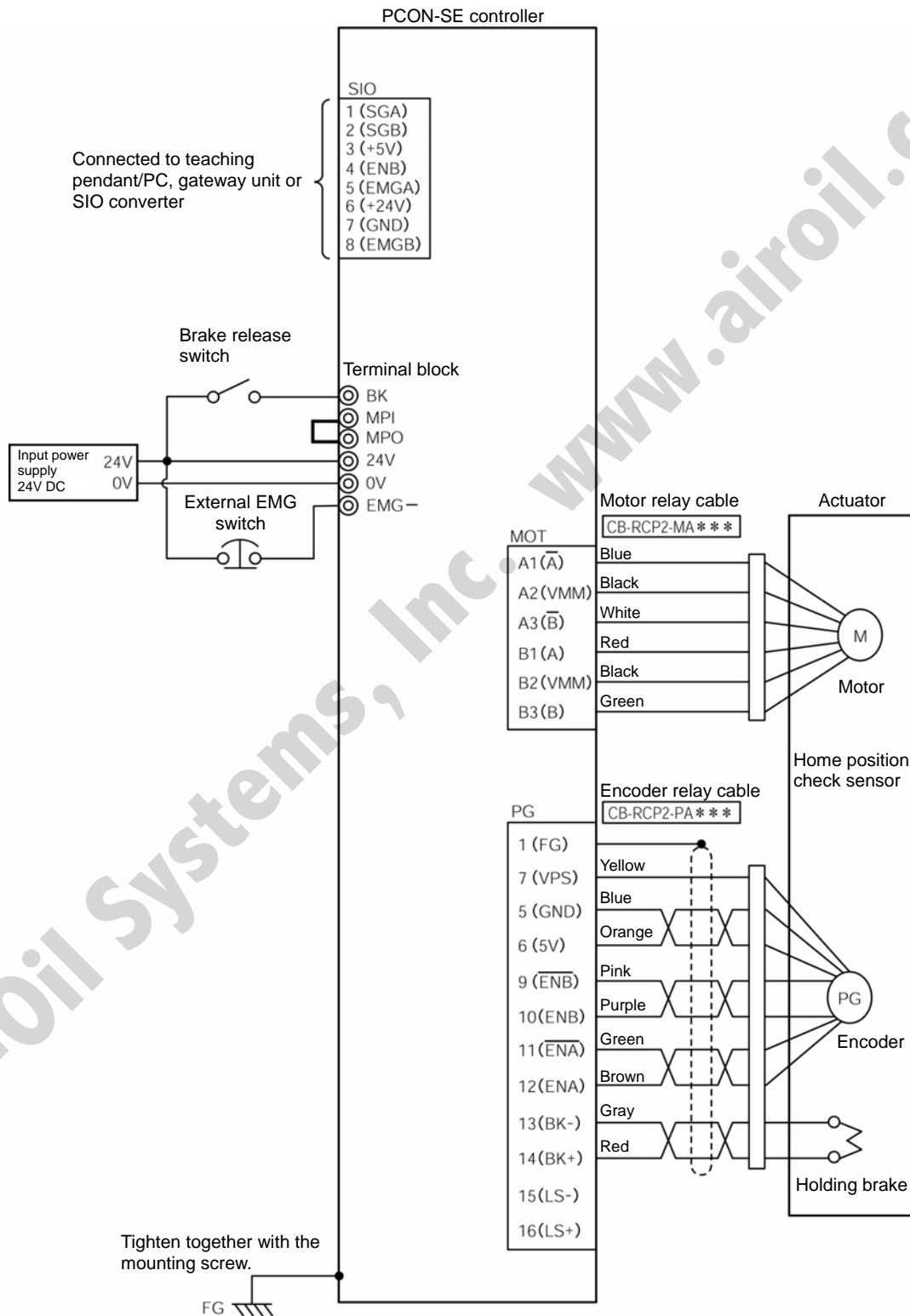

3.6 Wiring the Power Supply

Connect the +24V side of the 24V DC power supply to the 24V terminal on the power supply terminal block and the 0V side to the 0V terminal.

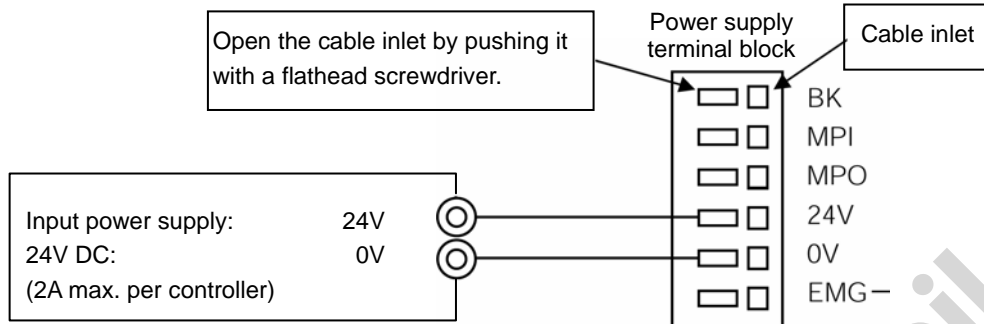

Use a power cable satisfying the following specifications:

Item	Description
Applicable wire	<p>Twisted wire: AWG size 22 (0.3 mm^2) (copper wire)</p> <p>(Note) Pay attention to terminal treatment to avoid a short circuit resulting from chips.</p> <p>If the wire path is long, install a relay terminal block and change the wire size.</p>
Insulating sheath temperature rating	60°C or more
Stripped wire length	

3.7 Wiring the Brake Release Switch to Forcibly Release the Brake

If the actuator is equipped with a brake, install the brake release switch for resetting at startup adjustment or in an emergency.

The switch (24V DC, contact capacity 0.2 A or more) must be prepared by the customer.

Connect one side of the switch to the positive side of the 24V DC power supply and the other side to the BK terminal on the power supply terminal block.

The brake will be released by closing the switch.

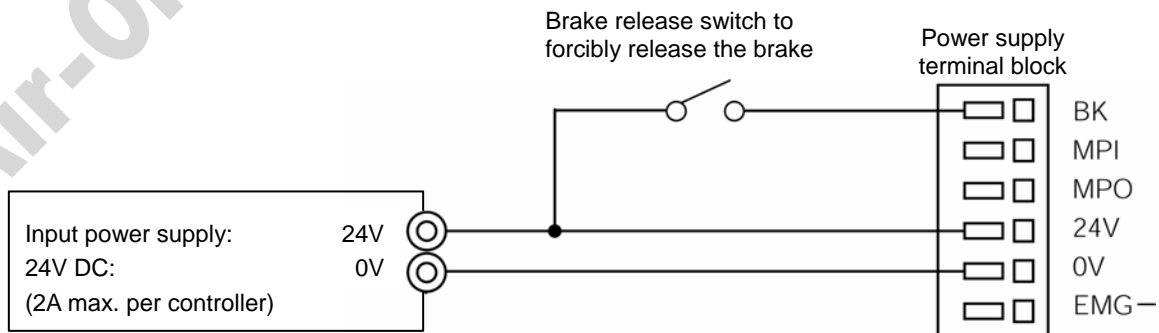

⚠ Danger: In the case of a vertical axis, release the brake while exercising caution to avoid hands from being caught and the robot hand or work from being damaged due to a sudden drop.

3.8 Wiring the Emergency Stop Circuit

3.8.1 Drive Signal Shutdown (Standard)

The motor drive is stopped by the controller internal circuit.
The motor drive power supply is not shut off.

(1) When the SIO converter is used

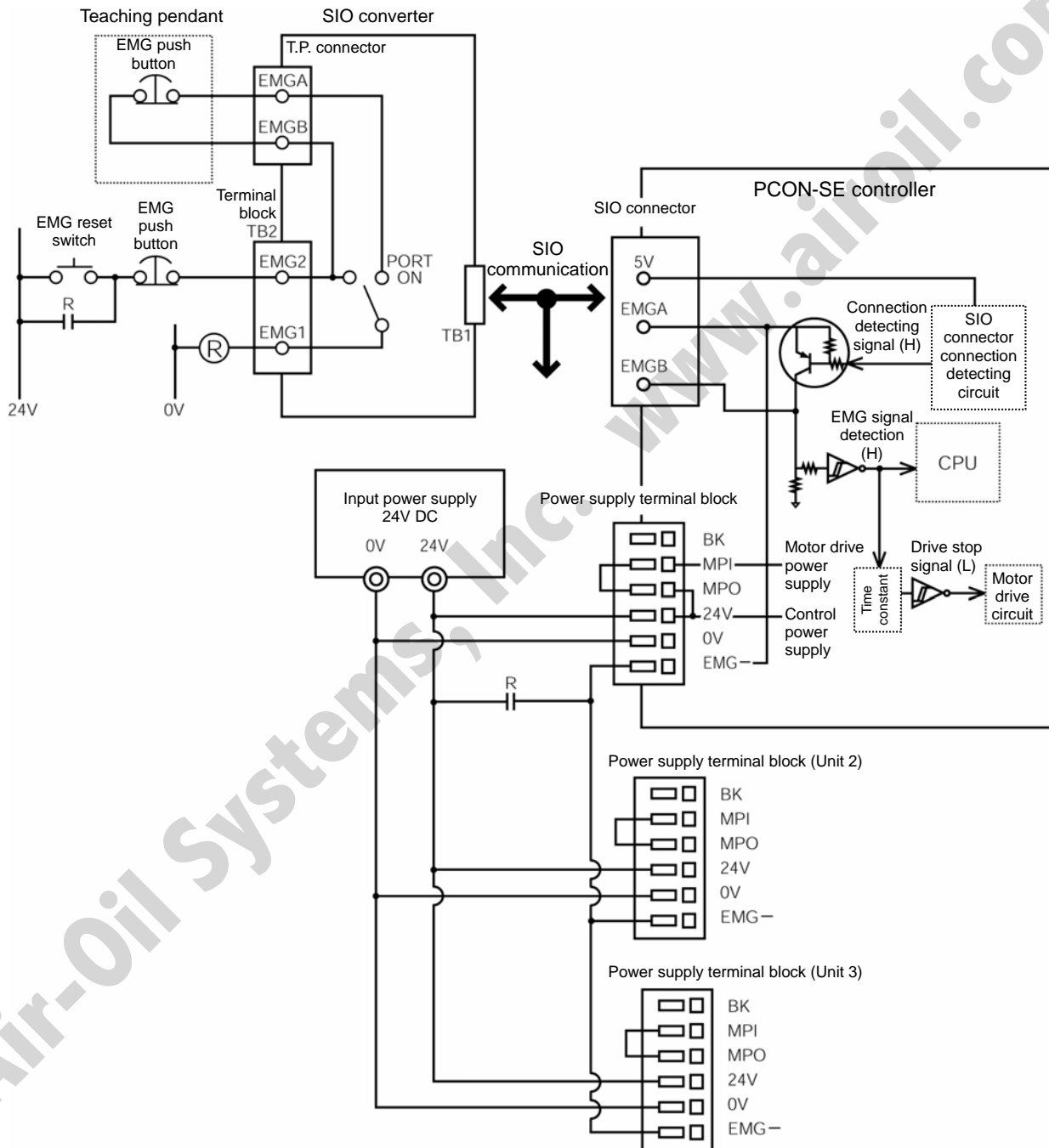

⚠ Caution: The input current to the EMG terminal of PCON-SE is 5 mA. When connecting the contact of the EMG relay R to the EMG terminals of multiple controllers, check the current capacity of the relay contact.

(2) When the gateway unit is used

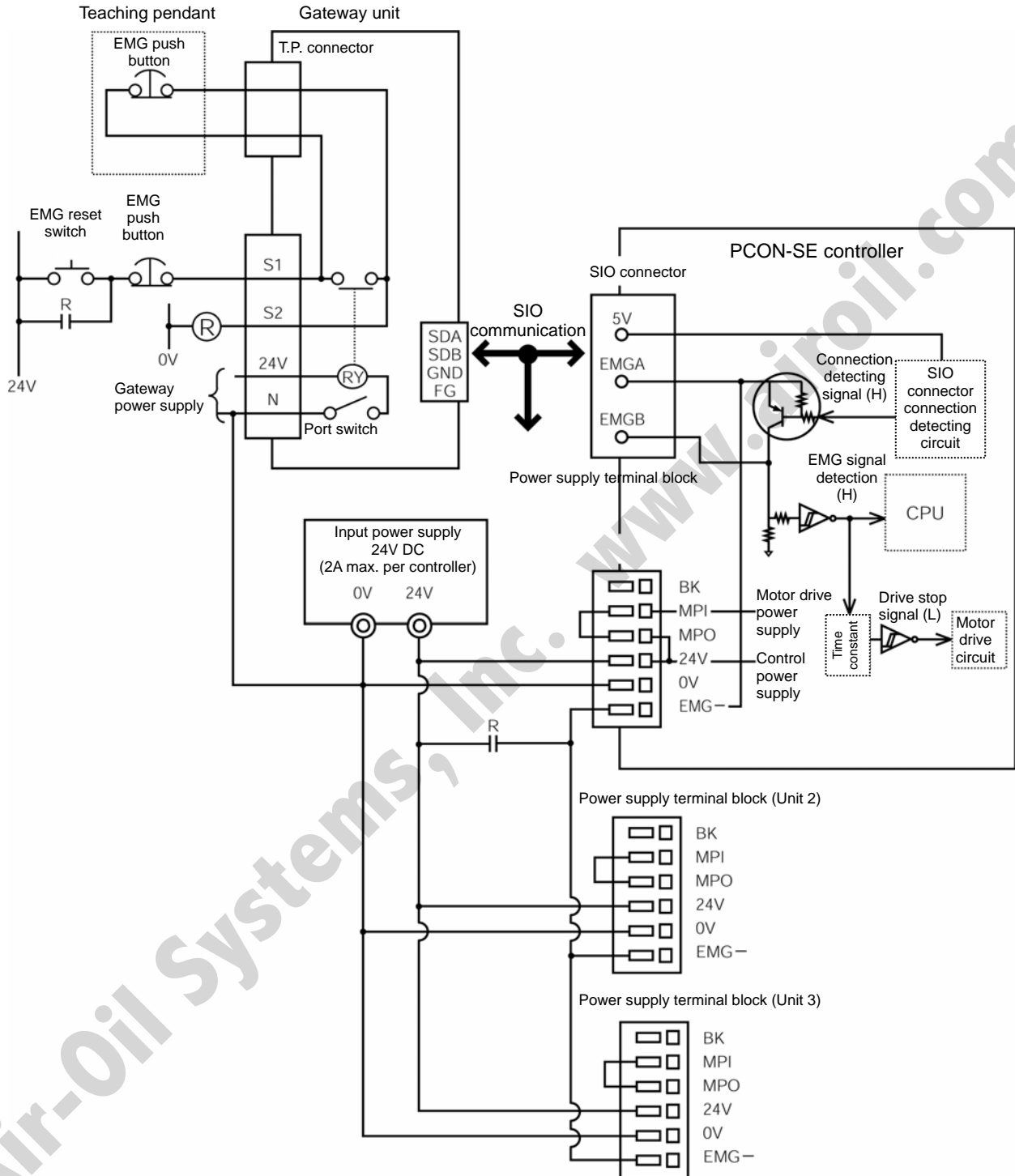

- ⚠ Caution: (1) The input current to the EMG terminal of PCON-SE is 5 mA. When connecting the contact of the EMG relay R to the EMG terminals of multiple controllers, check the current capacity of the relay contact.
- (2) Make the 0V of the gateway unit power supply and PCON-SE power supply in common.

3.8.2 Cutting off the Motor Drive Power Supply

If the safety category of the entire equipment requires motor drive power cut off, connect the EMG relay contact between the MPI terminal and MPO terminal.

In addition, connect 24V of the controller power supply to the EMG terminal.

(Note) Please pay sufficient attention that the EMG switch of the teaching pendant leads to motor drive signal shutdown and not motor drive power cutoff.

(1) When the SIO converter is used

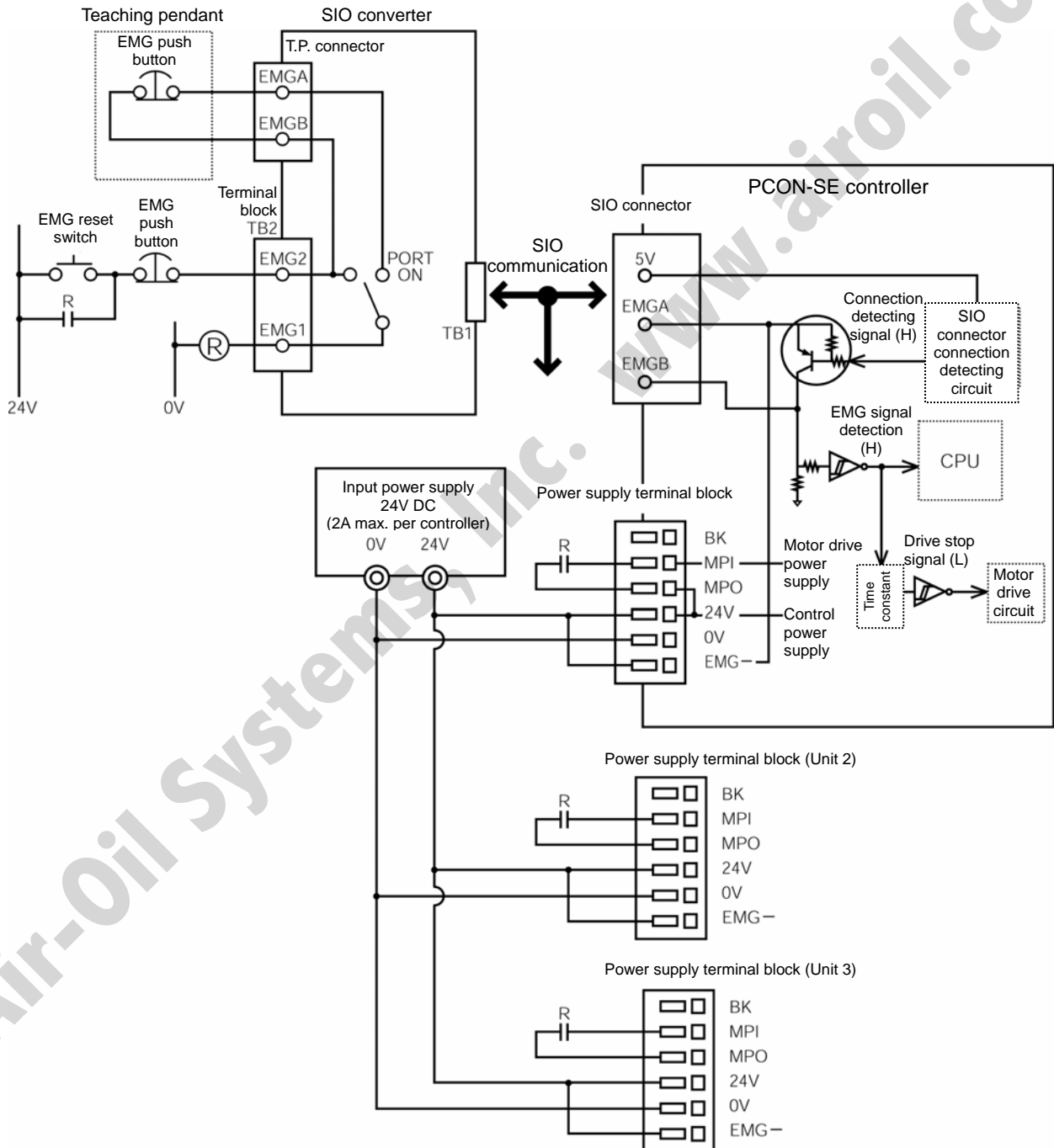

(2) When the gateway unit is used

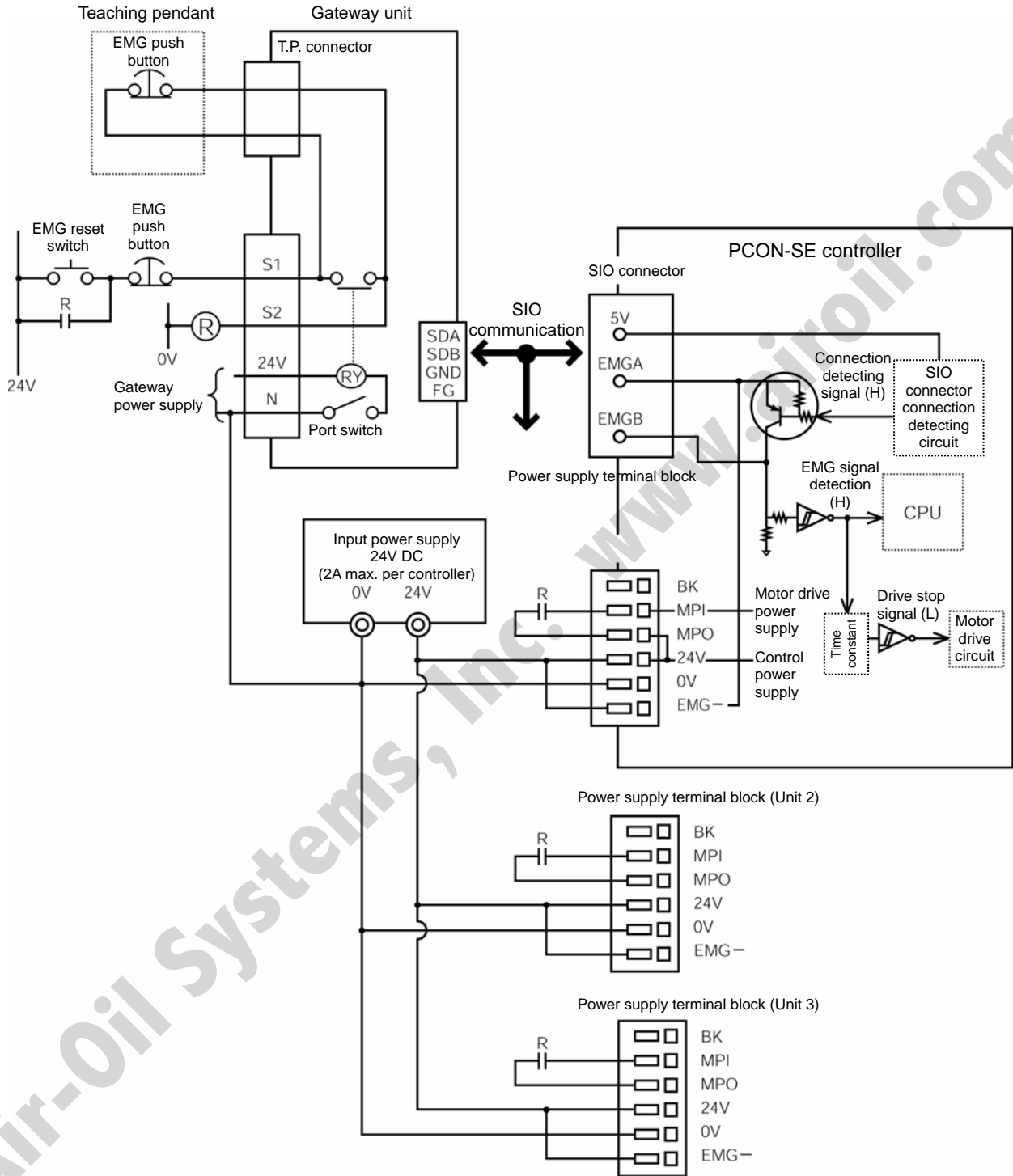

- ⚠ Caution:
- [1] The input current to the EMG terminal of PCON-SE is 5 mA. When connecting the contact of the EMG relay R to the EMG terminals of multiple controllers, check the current capacity of the relay contact.
 - [2] Make the 0V of the gateway unit power supply and PCON-SE power supply in common.

3.9 Connecting the Actuator

3.9.1 Motor Relay Cable

- Connect the motor relay cable to the MOT connector.

Signal table for the controller-end connector (CN2)

Pin No.	Signal	Wire Color	Description
A1	\bar{A}	Blue	Motor drive line (-A phase)
A2	VMM	Black	Motor power line
A3	\bar{B}	White	Motor drive line (-B phase)
B1	A	Red	Motor drive line (+A phase)
B2	VMM	Black	Motor power line
B3	B	Green	Motor drive line (+B phase)

Controller end

CN2 pin assignments

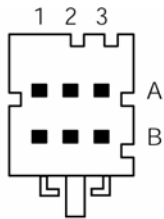

Actuator end

CN1 pin assignments

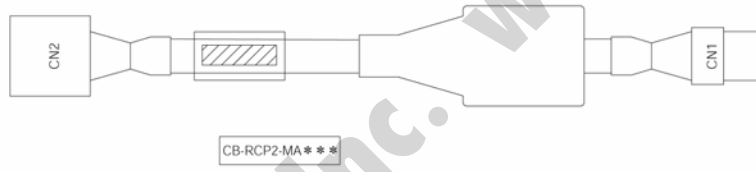
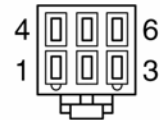

CN2

Cable Color	Signal Name	Pin No.
Red	\bar{A}	A1
Black	VMM	A2
White	\bar{B}	A3
Red	A	B1
Black	VMM	B2
Green (Yellow 3)	B	B3

Housing: 1-1318119-3 (AMP)
Receptacle contact: 1318107-1

CN1

Pin No.	Signal Name	Cable Color
1	A	Red
2	VMM	Black
3	\bar{A}	Blue
4	B	Green (Yellow 3)
5	VMM	Black
6	\bar{B}	White

Housing: SLP-06V (J.S.T. Mfg.)
Socket contact: BSF-21T-P1.4

3.9.2 Encoder Relay Cable

- Connect the encoder relay cable to the PG connector.

Signal table for the controller-end connector (CN2)

Pin No.	Signal Name	Description
1	F.G	Shielded wire
2	—	(Not used)
3	—	(Not used)
4	—	(Not used)
5	GND	Encoder power output
6	5V	
7	VPS	Encoder control signal output
8	—	(Reserved)
9	$\overline{\text{ENB}}$	Encoder differential signal phase-B input
10	ENB	
11	$\overline{\text{ENA}}$	Encoder differential signal phase-A input
12	ENA	
13	BK-	Negative side of the brake power supply
14	BK+	Positive side of the brake power supply
15	LS-	Home position check sensor
16	LS+	

Controller end

CN2 pin assignments

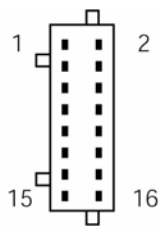

Actuator end

CN1 pin assignments

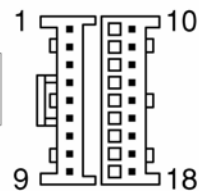

CN2

Cable Color		Signal Name	Pin No.
Robot cable	Standard cable		
—	—	LS+	16
—	—	LS-	15
Orange (Black 1)	Red	BK+	14
Orange (Red 1)	Gray	BK-	13
Light gray (Black 1)	Brown	ENA	12
Light gray (Red 1)	Green	$\overline{\text{ENA}}$	11
White (Black 1)	Purple	ENB	10
White (Red 1)	Pink	$\overline{\text{ENB}}$	9
—	—	(Reserved)	8
Yellow (Black 1)	Yellow	VPS	7
Pink (Red 1)	Orange	5V	6
Pink (Black 1)	Blue	GND	5
—	—	—	4
—	—	—	3
—	—	—	2
Drainage	Drainage	F.G	1

CN1

Pin No.	Signal Name	Cable Color	
		Standard cable	Robot cable
1	ENA	Brown	Light gray (Black 1)
2	$\overline{\text{ENA}}$	Green	Light gray (Red 1)
3	ENB	Purple	White (Black 1)
4	$\overline{\text{ENB}}$	Pink	White (Red 1)
5	—	—	—
6	—	—	—
7	—	—	—
8	—	—	—
9	GND	Blue	Pink (Black 1)
10	5V	Orange	Pink (Red 1)
11	VPS	Yellow	Yellow (Black 1)
12	—	—	—
13	—	—	—
14	—	—	—
15	—	—	—
16	BK+	Red	Orange (Black 1)
17	BK-	Gray	Orange (Red 1)
18	F.G	Drainage	Drainage

Housing: PHDR-16VR (J.S.T. Mfg.)

Contact: SPHD-001T-P0.5

Housing: XMP-18V (J.S.T. Mfg.)

Contact: BXA 001T-P0.6

Retainer: XMS 09V

3.10 Connecting the SIO Communication

3.10.1 Connecting the RS232C Serial Communication

(1) Basic information

Connect the teaching pendant, PC or PLC, and controller using the SIO converter (RS232C/RS485 conversion) as shown below.

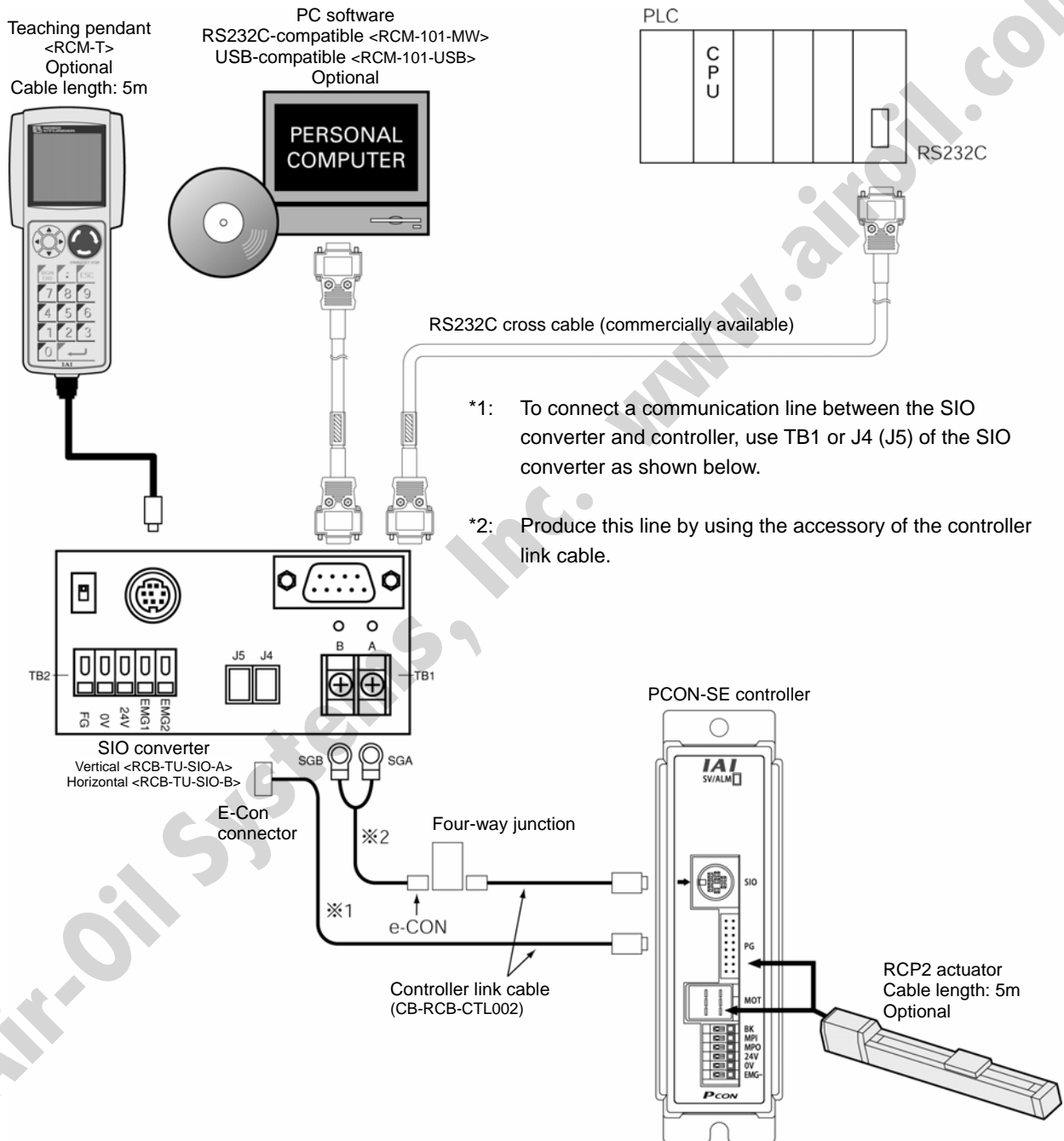

Caution: Do not connect the teaching pendant and PC at the same time. If the both are connected at the same time, a communication error (message level) will occur. Make the 0V of the SIO converter and controller in common.

(2) Connecting the multiple axes

Item	Description
Maximum number of units that can be connected	16 axes max. (depending on the operation mode)
Communication cable length	Total cable length: 100m or less
SIO communication main line	Twisted-pair shielded cable (AWG22) Recommended brand: Taiyo Electric Wire & Cable HK-SB/20276 x L, 2P x AWG22
Terminal resistor	220Ω, 1/4W

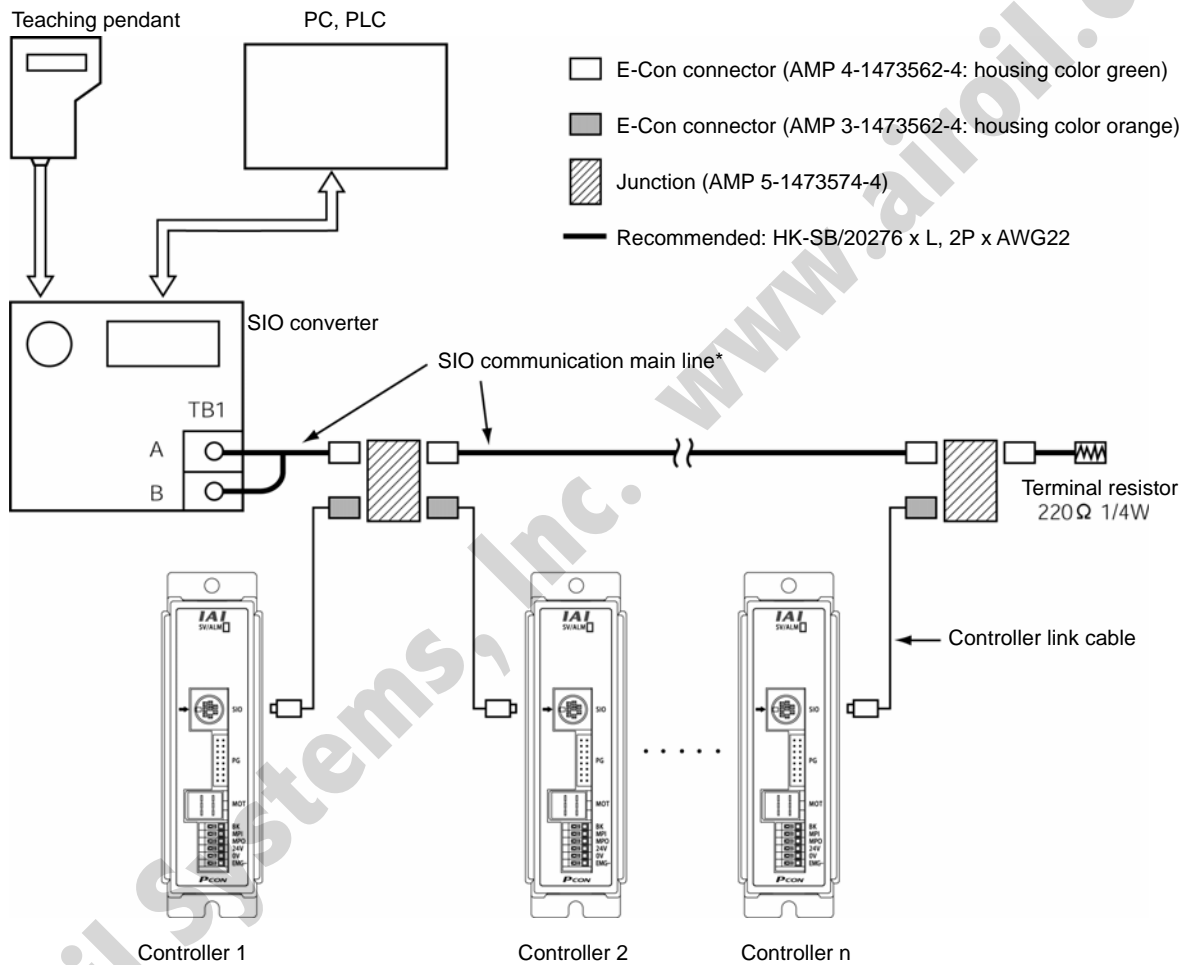

* The SIO communication main line must be prepared by the customer.
Each one unit of the junction, E-Con connector and terminal resistor are supplied with the controller link cable.

- ⚠ Caution:
- [1] If normal communication cannot be performed with a communication error occurring when the total communication cable length is 10m or more, connect the terminal resistor to the last axis.
 - [2] For the power supplies of the SIO converter and all controllers, make 0V in common.
 - [3] Connect a shielded cable to FG on an axis basis.
 - [4] If the total link cable length is more than 30m, use the wire size of 22AWG or larger.

Detail Connection Diagram

The diagram below shows the details of the SIO communication connection. The controller link cables are optionally prepared, but the communication main line must be prepared by the customer.

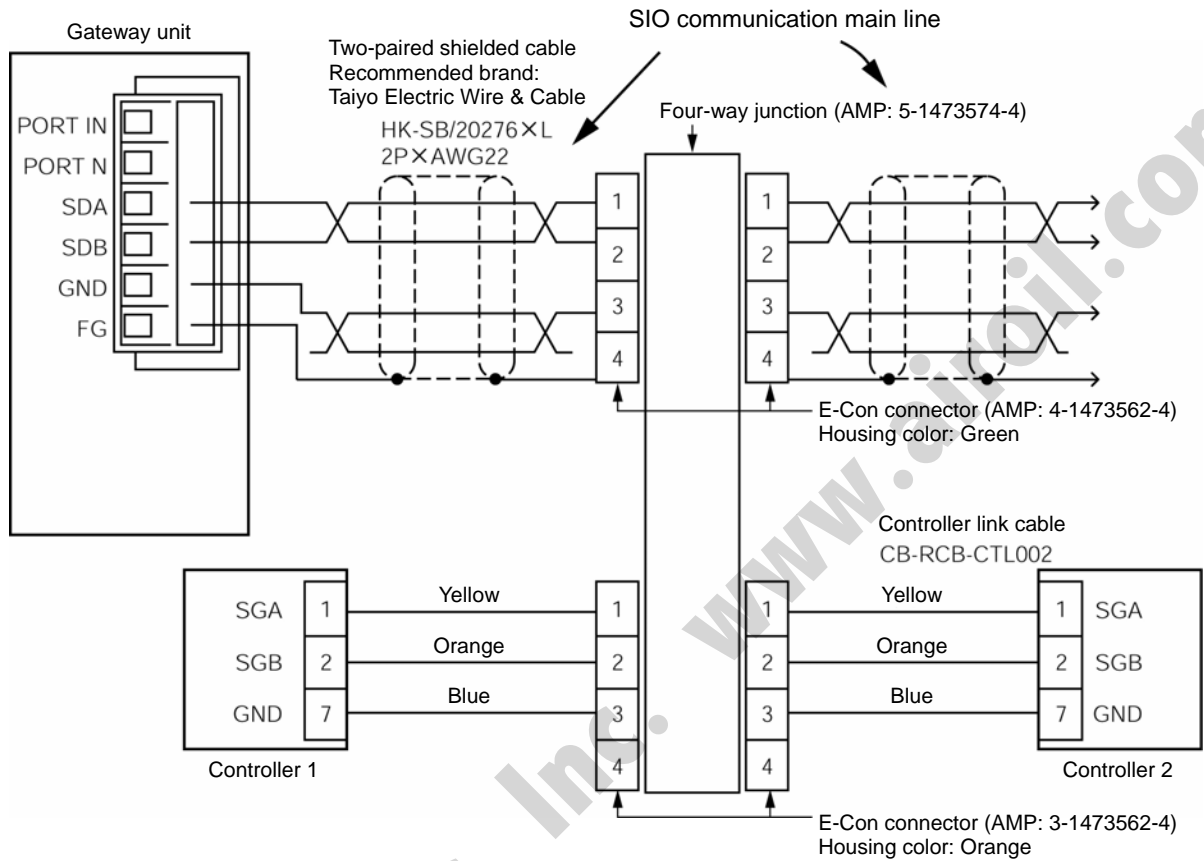

Preparation of Communication Main Line

- [1] Strip off approx. 15-20mm of the sheath from the two-paired shielded cable.
- [2] Install the cable protective tube.
- [3] Insert three cables into the cable insertion hole of the connector without stripping off the envelope of the conductors.
- [4] Pressure-weld the cable press-fit housing with the cables inserted from above.
- [5] Heat-treat the cable protective tube.

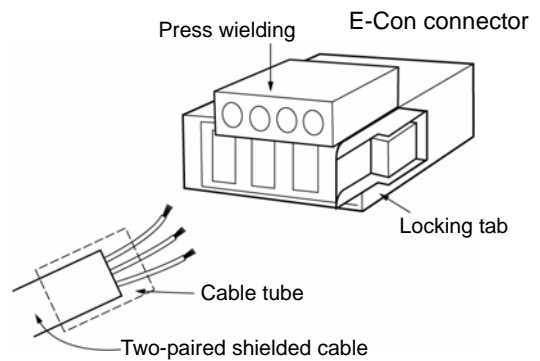

Pin numbers of E-Con connector

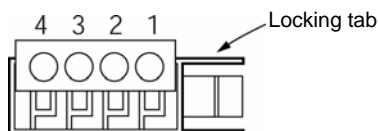

Be sure to insert the terminal resistor (220Ω , $1/4W$) into the end of the communication main line. (between No. 1 and No. 2 of the E-Con connector)

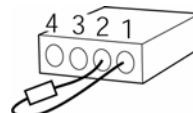

P CON

■ Controller Link Cable (CB-RCB-CTL002)

* Controller's option

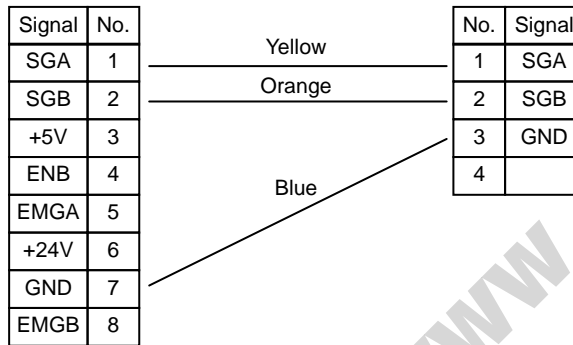
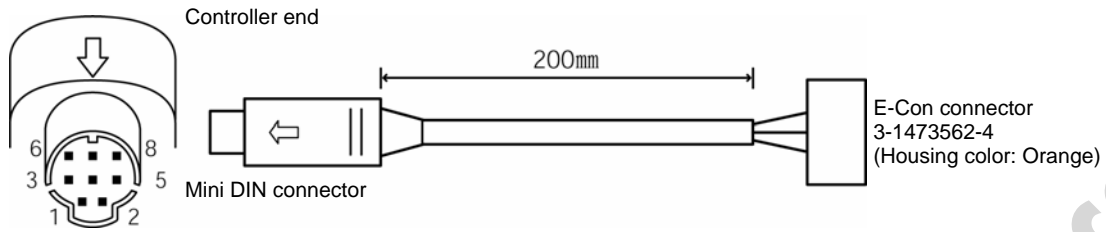

The following parts are provided together:

- [1] Four-way junction
Model: 5-1473574-4, Manufacturer: MP, Quantity: 1
- [2] E-Con connector
Model: 4-1473562-4, Manufacturer: MP, Quantity: 1
Compatible wire coating outline: 1.35-1.6mm
- [3] Terminal resistor: 220Ω, 1/4W, with E-Con connector, Quantity: 1

3.10.2 Connection to Field Network

The gateway unit is used to connect the controllers to the field network of DeviceNet, CC-Link, or Profibus. The connection to the gateway unit is shown below. The details are the same as those in 3.10.1 (2).

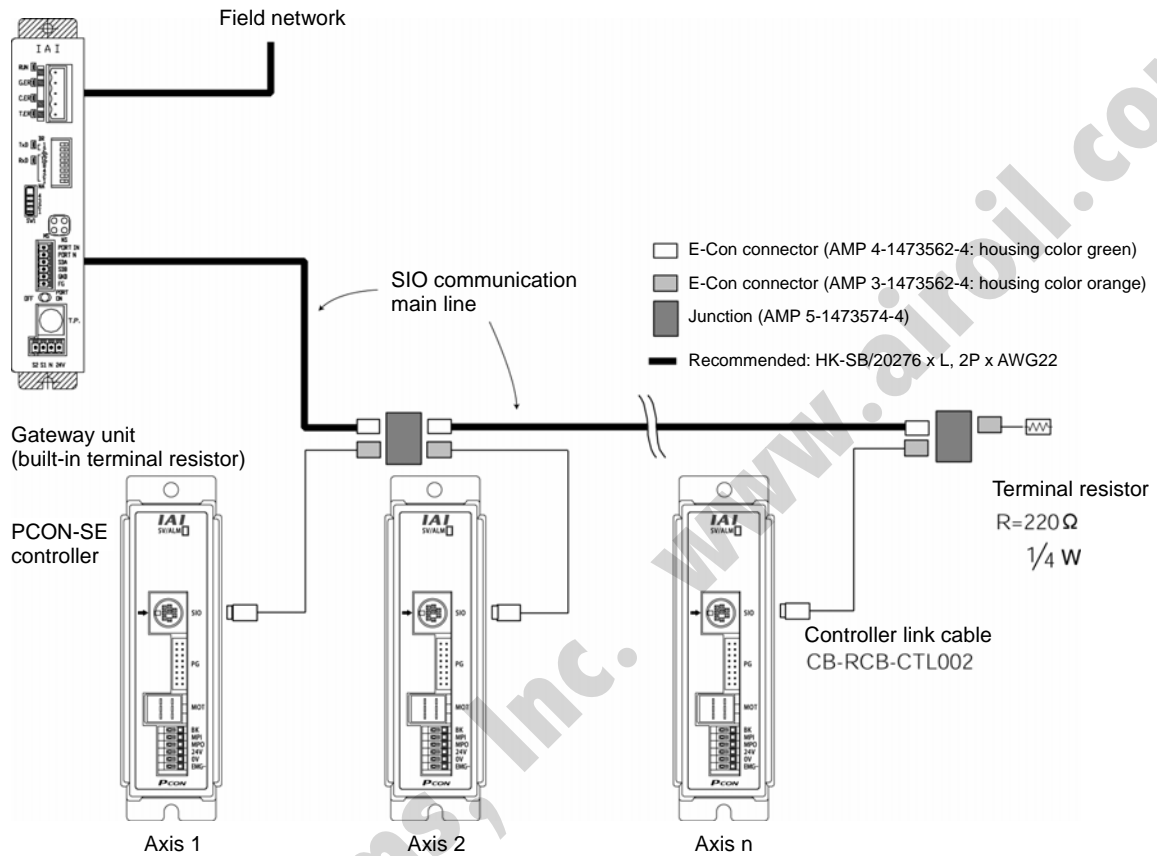

4. Description of Operating Functions

The operating modes of PCON-SE are the same as those of the standard type of PCON-CY.

As the methods of operating PCON-SE, there are the [1] "position no. specification mode" to operate the controller by specifying the position number via serial communication and the [2] "numeric specification mode" to operate the controller by directly specifying the numeric values relative to operation via serial communication.

To move the actuator to a specified position in the "position no. specification mode," it is basically required to create a position table in advance and enter a target position in the "Position" field. For the target position, there are the absolute coordinate specification (Absolute) to enter a distance from the home position and the relative coordinate specification (Incremental) to enter a relative movement distance from the current position.

When the target position is entered, the default value set with a parameter is automatically registered in the other field. The default value varies depending on the actuator characteristics.

Air-Oil Systems, Inc. www.airoil.com

4.1 Description of Position Table

A position table is created by using the PC software or teaching pendant.

For its usage, refer to each operation manual.

In this section, a position table is explained by taking the PC software screens as examples.

(In the case of the teaching pendant, the display contents are different.)

No.	Position [mm]	Speed [mm/s]	Acceleration [G]	Deceleration [G]	Push [%]	Threshold [%]	Positioning band [mm]
0	5.00	300.00	0.30	0.30	0	0	0.10
1	380.00	300.00	0.30	0.10	0	0	0.10
2	200.00	300.00	0.30	0.10	0	0	0.10

Zone + [mm]	Zone - [mm]	Acceleration mode	Incremental	Command mode	Stop mode	Comment
100.00	0.00	0	0	0	4	
400.00	300.00	0	0	0	0	
250.00	150.00	0	0	0	0	

(1) No.: Indicate the position data number.

(2) Position: Enter the target position to move the actuator to, in [mm].

Absolute coordinate specification: Enter the distance to the target actuator position from the home.

Relative coordinate specification: Under the assumption of a constant pitch, a relative amount from the current position is indicated.

No.	Position [mm]	
0	5.00	Absolute coordinate specification: 5mm from the home
1 →	10.00	Relative coordinate specification: +10mm from the current position
2 =	-10.00	Relative coordinate specification: -10mm from the current position

* Indicates the incremental mode with the teaching pendant.

(3) Speed: Enter the speed at which the actuator will be moved, in [mm/sec].

The default value varies depending on the actuator type.

- (4) Acceleration/deceleration: Enter the acceleration/deceleration at which the actuator will be moved, in [G].
 Basically, use acceleration/deceleration within the catalog rated value range.
 The input range allows larger value input than the catalog rated values, on the assumption that the tact time will be reduced if the transfer mass is significantly smaller than the rated value.
 Make the numeric value smaller if transfer work vibrates and causes trouble during acceleration/deceleration.

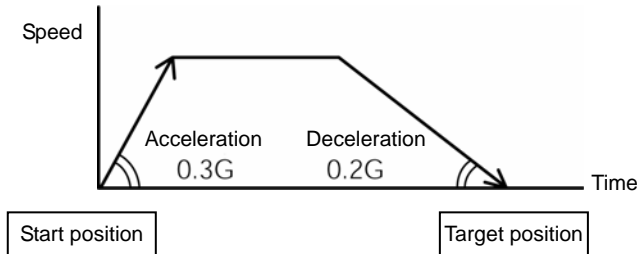

The acceleration will become sudden if the numeric value is made larger, and it will become gradual if the numeric value is made smaller.

⚠ Caution: Enter appropriate values for the speed and acceleration/deceleration in such a way as to prevent excessive impact or vibration from being applied to the actuator in consideration of the installation conditions and the shape of transferred work by referring to the "List of Actuator Specifications" in the Appendix.
 Increasing such values largely relates to the transfer mass and the actuator characteristics vary depending on the model, consult IAI regarding the input-limiting values.

- (5) Push: Select the positioning operation or push & hold operation.
 The default value is "0."
 0: Normal positioning operation
 Other than 0: Indicates the current-limiting value and indicates the push & hold operation.
- (6) Threshold: This field is invalid in the case of this controller.
 The default value is "0."
- (7) Positioning band: The "positioning operation" and "push & hold operation" have different implications.

Positioning operation

It defines the distance to the target position from a position at which the position complete signal turns ON.

Since increasing the positioning band value hastens the next sequence operation, it becomes a factor for tact time reduction. Set the optimum value by considering a balance of the entire equipment.

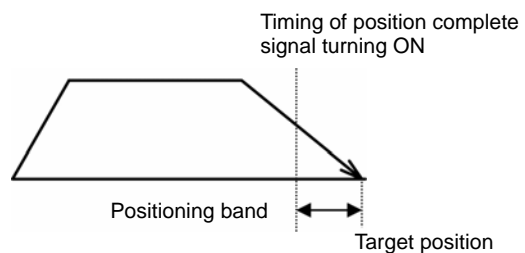

Push & hold operation

It defines the maximum push amount from the target position in the push & hold operation.

Set the positioning band in such a way as to prevent positioning completion before the actuator contacts work by considering mechanical variations of work.

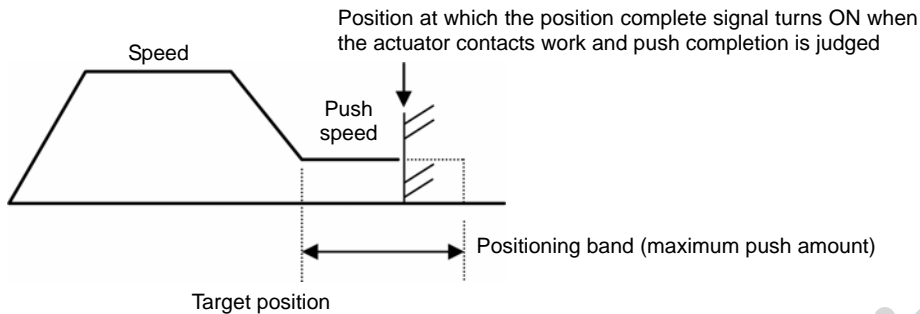

- (8) Zone +/-: It defines the zone where the zone output signal turns ON. It can be set separately for each target position to offer flexibility.

[Setting example]

No.	Position [mm]	Zone + [mm]	Zone - [mm]	Comment
0	5.00	100.00	0.00	
1	380.00	400.00	300.00	
2	200.00	250.00	150.00	

Movement command to position No. 0

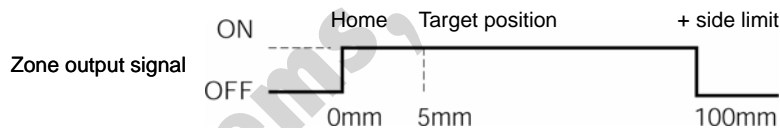

Movement command to position No. 1

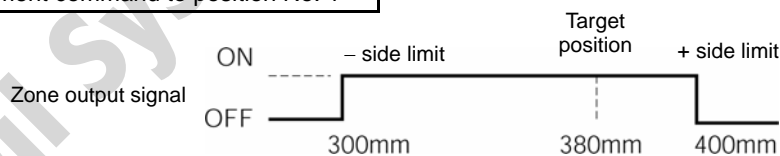

P CON

- (9) Acceleration/deceleration mode: This field is invalid in the case of this controller.
The default value is 0.
- (10) Incremental: It defines whether the specification is the absolute coordinate specification or relative coordinate specification.
The default value is 0.
0: Absolute coordinate specification
1: Relative coordinate specification
- (11) Command mode: This field is invalid in this controller.
The default value is 0.
- (12) Stop mode: This field is invalid in this controller.
The default value is 0.
The power saving method on standby is set with parameter No. 53.
The full servo control method can be selected with the set value 4.

Full servo control method

The holding current (stall current after completion of positioning) can be reduced by servo-controlling the pulse motor.

The degree of reduction varies depending on the actuator model, load condition, etc., but the holding current decreases by an approximate factor of 2 to 4.

No displacement occurs since this method maintains the servo ON status.

The actual holding current can be confirmed on the current monitoring screen of PC-compatible software.

Set the value to 4 to enable this method.

4.2 Notes on Robo Gripper

(1) Finger operation

[1] Definition of position

The stroke in the two-finger type specification represents the sum of travels of both fingers.

Therefore, the travel of one finger is one-half the stroke.

The position is specified as a travel of one finger from the home toward the closing side.

Accordingly, the maximum command value is 5mm for the GRS type and 7mm for the GRM type.

[2] Definition of speed and acceleration

The command value applies to each finger.

Therefore, the relative speed and acceleration are twice their respective command values in the two-finger type.

[3] Operation mode in gripper applications

When the actuator is used to grip work, be sure to select the "push & hold mode."

(Note) In the "positioning mode," a servo error may occur while the work is gripped.

[Diagrams of gripping force and current-limiting value]

[GRS]

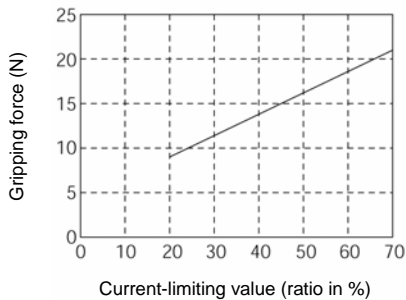

[GRM]

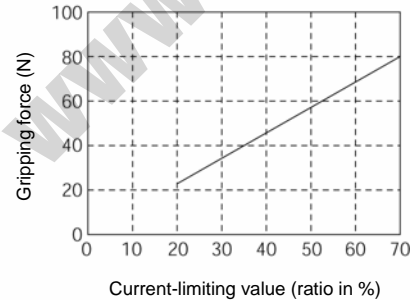

[GR3SS]

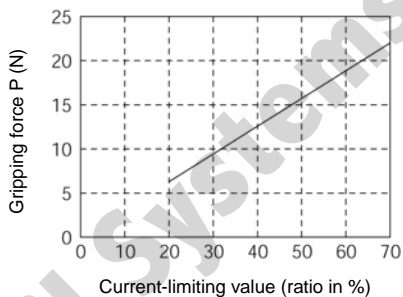

[GR3SM]

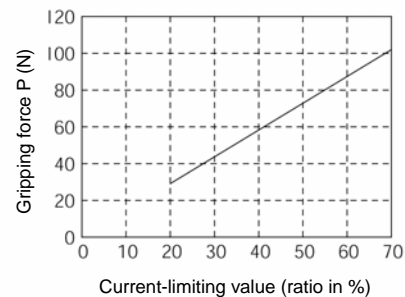

[GR3LS]

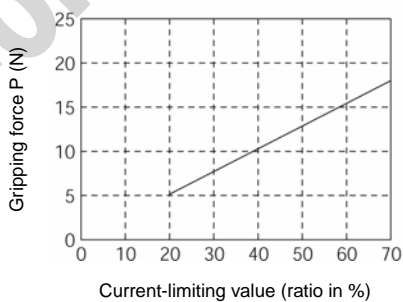

[GR3LM]

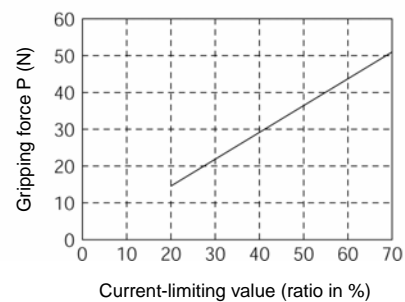

(2) Removing the gripping work

This gripper is designed to maintain the work-gripping force via self-lock mechanism even when the servo is turned OFF or the controller power is cut off.

If the gripped work must be removed while the power is cut off, do so by turning the open/close screw or removing the finger attachment on one side.

[Two-finger type]

Turn the open/close screw or remove the finger attachment on one side.

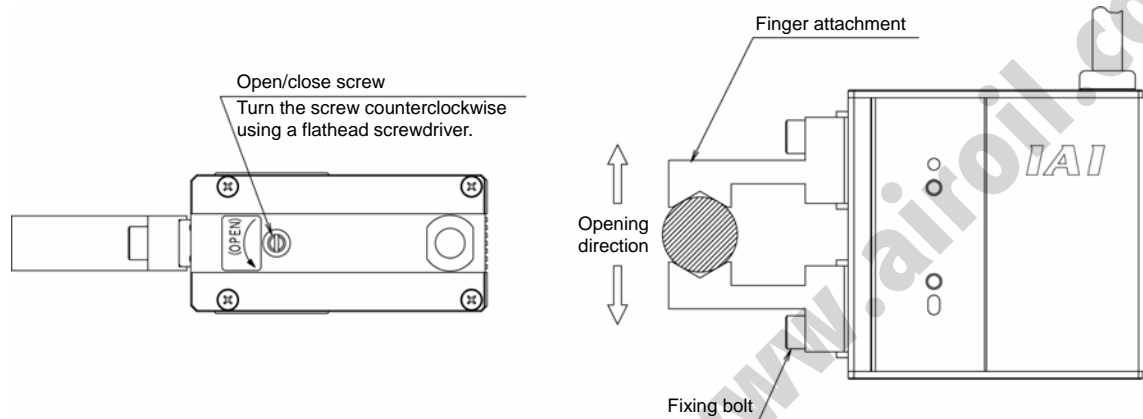

[Three-finger type]

Remove one finger attachment.

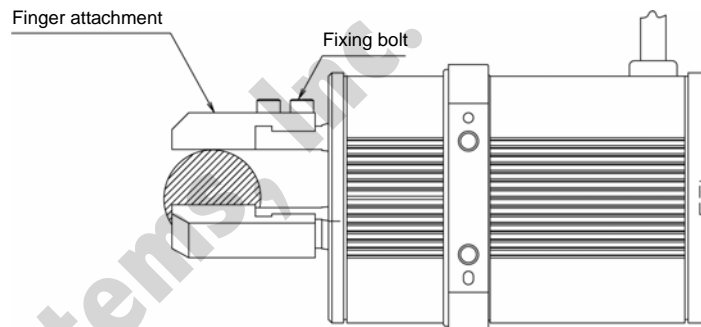

4.3 Setting Data in Numeric Specification Mode

If operation is performed in the numeric specification mode, the position table will become invalid. Set the data related to operation (target position, speed, acceleration/deceleration, current-limiting value during push & hold operation, positioning band, etc.) directly via serial communication.

For details, refer to the Gateway Unit Operation Manual and Serial Communication Operation Manual.

4.4 Description of Functions

The table on the following page shows the main functions of the position no. specification mode and numeric specification mode in PCON-SE.

Air-Oil Systems, Inc. www.airoil.com

List of PCON-SE Functions

○: Direct control

△: Indirect control

×: Invalid

	Position no. specification mode		Numeric specification mode							
	Serial communication	Gateway	Serial communication	DeviceNet gateway		CC-Link gateway				
				Numeric specification	Simple direct value/position no. specification	Position data limited specification	Positioning data specification	Data specification push & hold	Simple direct value/position no. specification	
Home return operation	○	○	○	○	○	○	○	○	○	○
Positioning operation	△ Specify the position no.	△ Same as at the left	○ Specify the position data directly.	○ Specify the position data directly.	○ Specify the position data directly. ○ Specify the position table no.	○ Specify the position data directly.	○ Specify the position data directly.	○ Specify the position data directly.	○ Specify the position data directly.	○ Specify the position data directly. ○ Specify the position table no.
Speed setting	△ Set it in the position table.	△ Same as at the left	○ Specify a numeric value directly.	○ Specify a numeric value directly.	△ Set it in the position table.	△ Set the parameter.	○ Specify a numeric value directly.	○ Specify a numeric value directly.	○ Specify a numeric value directly.	△ Set it in the position table.
Acceleration/deceleration setting	△ Set the acceleration and deceleration separately in the position table.	△ Same as at the left	○ Specify a numeric value as the acceleration/ deceleration.	○ Specify a numeric value as the acceleration/ deceleration.	△ Set the acceleration and deceleration separately in the position table.	○ Set the parameter as the acceleration/ deceleration.	○ Specify a numeric value as the acceleration/ deceleration.	○ Specify a numeric value as the acceleration/ deceleration.	○ Specify a numeric value as the acceleration/ deceleration.	△ Set it in the position table.
Operation at different acceleration/deceleration	△ Set the acceleration and deceleration separately in the position table.	△ Same as at the left	○ The acceleration/ deceleration data is accepted at positioning start time. Therefore, to specify the deceleration different from the acceleration, change the acceleration/ deceleration data during movement and restart the controller.	○ The acceleration/ deceleration data is accepted at positioning start time. Therefore, to specify the deceleration different from the acceleration, change the acceleration/ deceleration data during movement and restart the controller.	△ Set the acceleration and deceleration separately in the position table.	× Since parameter setting is performed as the acceleration/ deceleration, the acceleration and deceleration cannot be set separately.	○ The acceleration/ deceleration data is accepted at positioning start time. Therefore, to specify the deceleration different from the acceleration, change the acceleration/ deceleration data during movement and restart the controller.	○ The acceleration/ deceleration data is accepted at positioning start time. Therefore, to specify the deceleration different from the acceleration, change the acceleration/ deceleration data during movement and restart the controller.	△ Set the acceleration and deceleration separately in the position table.	
Pitch (incremental) feeding	△ Set it in the position table.	△ Same as at the left	○ If bit 2 of the CTF control flag is set to "1," incremental operation starts.	× Direct processing cannot be performed. Issue a position command by adding the same distance to or subtracting it from the current position with the host PLC.	△ Set it in the position table.	× Direct processing cannot be performed. Issue a position command by adding the same distance to or subtracting it from the current position with the host PLC.	× Direct processing cannot be performed. Issue a position command by adding the same distance to or subtracting it from the current position with the host PLC.	× Direct processing cannot be performed. Issue a position command by adding the same distance to or subtracting it from the current position with the host PLC.	△ Combine two or more position nos.	
Push & hold operation	△ Set it in the position table.	△ Same as at the left	○	○ Specify a numeric value directly.	△ Set it in the position table.	×	×	○	△ Set it in the position table.	
Speed change during movement	△ Combine two or more position nos.	△ Same as at the left	○ The speed data is accepted at positioning start time. Therefore, to change the speed during movement, change the speed data during movement and restart the controller.	○ The speed data is accepted at positioning start time. Therefore, to change the speed during movement, change the speed data during movement and restart the controller.	△ Combine two or more position nos.	×	○ Direct processing cannot be performed. Issue a position command by adding the same distance to or subtracting it from the current position with the host PLC.	○ Direct processing cannot be performed. Issue a position command by adding the same distance to or subtracting it from the current position with the host PLC.	△ Combine two or more position nos.	
Pause	○	○	○	○	○	○	○	○	○	
Zone signal	○ Set it in the position table or with the user parameter. Output signal: PZONE, ZONE1, ZONE2	○ Set it with the user parameter. Output signal: ZONE1, ZONE2	○ Set it with the user parameter. Output signal: ZONE1, ZONE2	×	Simple direct value axis: × Position no. specification axis pattern: 0, 1, 2, 4 → ○	×	×	×	Simple direct value axis: × Position no. specification axis pattern: 0, 1, 2, 4 → ○	
Power saving mode	○ The power saving mode in full servo control can be selected with the parameter 53. (The auto servo off mode cannot be selected.)	○ Same as at the left	○ Same as at the left	○ Same as at the left	○ Same as at the left	○ Same as at the left	○ Same as at the left	○ Same as at the left	○ Same as at the left	
Position table	Required	Required	Not required	Not required	Required	Not required	Required	Required	Required	

4.4.1 Control Signals, Control Data

In order to operate PCON-SE via serial communication, it is required to write/read the 16-bit internal memory (Modbus register, Modbus status) of the controller. The main signals and their symbol names handled at that time are shown below.

For details, refer to the Serial Communication Operation Manual.

(1) Controller Input Signals

(PLC → Controller)

Register	Bit address	Bit position	Signal symbol	Signal name	Description
Device control register DRG1 Address 0D00H		15	—	—	
		14	SFTY	Safety speed command	Safety speed set with the parameter 0: Invalid, 1: Valid
		13	—	—	
	0403H	12	SON	Servo ON command	0: Servo OFF, 1: Servo ON
		11 – 9	—	—	—
	0407H	8	RES	Alarm reset	0: Normal, “0” → “1” rise edge: Alarm reset
		7	—	—	—
		6	—	—	—
	040AH	5	STP	Pause command	0: Normal, 1: Pause (deceleration stop)
	040BH	4	HOME	Home return command	“0” → “1” rise edge: Home return operation
040CH	3	CSTR	Positioning start	0: Normal, “0” → “1” rise edge: Positioning start to the target position specified with the position no.	
[Common]		2 – 0	—	—	—

(Note) The meanings of [Common], [POS specification] and [Numeric specification] are as follows:

- [Common]: Used in common in both of the position no. specification mode and numeric specification mode
- [POS specification]: Used in the position no. specification mode
- [Numeric specification]: Used in the numeric specification mode

P CON

(PLC → Controller)

Register	Bit address	Bit position	Signal symbol	Signal name	Description
Position no. specification register		15 – 6	—	—	—
POSR	043AH	5	PC32	—	Specify the command position no. with the 6-bit binary code.
	043BH	4	PC16	—	
Address 0D03H	043CH	3	PC8	—	Setting the position start signal CSTR to “1” starts positioning operation.
	043DH	2	PC4	—	
[POS specification]	043EH	1	PC2	—	
	043FH	0	PC1	—	
Position no. specification register	—	15 – 6	—	—	—
POSR	—	5	PC32	—	The same description as the above. However, if the position number is specified in this register, positioning operation starts at the same time as writing.
	—	4	PC16	—	
Address 9800H	—	3	PC8	—	It is not required to set the start signal CSTR to “1.”
	—	2	PC4	—	
[POS specification]	—	1	PC2	—	
	—	0	PC1	—	

(PLC → Controller)

Register	Address	Description
PCMD Position data specification	9900H	High order 
	9901H	Low order 
[Numeric specification]		32-bit signed integer (unit: 0.01mm) It is treated as a positive number when the most significant bit is 0 or as a negative number when the most significant bit is 1. When the low-order word (9901H) in this register is rewritten, positioning operation starts.
INP Position data specification	9902H	High order 
	9903H	Low order 
[Numeric specification]		32-bit integer (unit: 0.01mm) Specify the position-complete detection width for positioning operation. It becomes the set value of the push width for push & hold operation (required to specify with the CTLF flag).
VCMD Speed specification	9904H	High order 
	9905H	Low order 
[Numeric specification]		32-bit integer (unit: 0.01 mm/sec) Specify the movement speed. When the lower-order word (9905H) in this register is rewritten, movement starts.
ACMD Acceleration/ deceleration	9906H	
	[Numeric specification]	16-bit integer (unit: 0.01G, setting range: 0 – 300) If any value exceeding the initial value of acceleration/deceleration is set to the parameter No. 9, an alarm will be generated at movement start time. When this register is rewritten, movement starts.

P CON

(PLC → Controller)

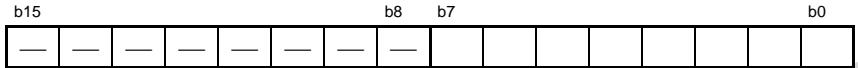
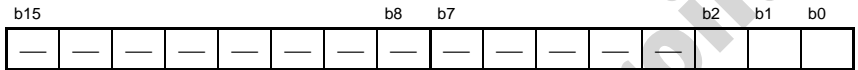
Register	Address	Description
PPOW Current-limiting value during push & hold operation [Numeric specification]	9900H	
		16-bit integer (unit: %, setting range: 00H – FFH) When this register is rewritten, movement starts.
CTLF Control flag [Numeric specification]	9906H	
		Bit pattern to set operation [1] Bit 0 (b0) 0: Normal operation, 1: Push & hold operation [2] Bit 1 (b1) 0: The push & hold direction after completion of approach operation is forward. 1: The push & hold direction after completion of approach operation is reverse. [3] Bit 2 (b2) 0: Normal operation, 1: Incremental operation

Air-Oil Systems, Inc.

(2) Controller output signals

(Controller → PLC)

Register	Bit address	Bit position	Signal symbol	Signal name	Description
Device status register DSS1	0100H	15	EMGS	Emergency stop status	1: Under emergency stop
	0101H	14	SFTY	Safety speed valid	1: Safety speed valid condition
	0102H	13	PWR	Controller ready	1: Controller preparation completed
	0103H	12	SV	Servo ready	1: Operation preparation completed (servo ON status)
Address 9005H	0104H	11	PSFL	Push & hold missing	1: Push & hold missing
	0105H	10	ALMH	Major failure status	1: Alarm indicating that continuous operation is impossible
	0106H	9	ALML	Minor failure status	1: Alarm indicating that continuous operation is impossible
		8 – 6	—	—	—
	010AH	5	STP	Pause commanding	1: Pause command being issued
	010BH	4	HEND	Home return completion	1: Home return completed
	010CH	3	PEND	Position complete	1: Positioning completed
[Common]		2 – 0	—	—	—
Expansion device status register DSSE		15 – 12	—	—	—
	0124H	11	GMHS	Home returning	1: Home returning
	0123H	10	PUSH	Push & hold operating	1: Push & hold operating
Address 9007H		9 – 6	—	—	—
	012AH	5	MOVE	Moving	1: Moving (including home return, push & hold operation)
[Common]		4 – 0	—	—	—

P CON

(Controller → PLC)

Register	Bit address	Bit position	Signal symbol	Signal name	Description
Zone status register ZONS		15 – 9	—	—	—
Address 9013H	0147H	8	PZONE	Position zone output	This signal becomes “1” when the current position is within the setting range if individual zone boundaries are set in the position table.
		7 – 2	—	—	—
[Common]	014EH	1	ZONE2	Zone output 2	This signal becomes “1” when the position is within the setting range of the parameter zone boundary 2.
	014FH	0	ZONE1	Zone output 1	This signal becomes “1” when the position is within the setting range of the parameter zone boundary 1.
Position no. status register POSS		15 – 6	—	—	—
Address 9014H	013AH	5	PM32		The position complete position no. is output as a 6-bit binary code.
	013BH	4	PM16		
	013CH	3	PM8		
	013DH	2	PM4		
	013EH	1	PM2		
	013FH	0	PM1		
[POS specification]					

(Controller → PLC)

Register	Address	Description																				
PNOW Current position	9900H	<table border="1" style="width: 100%; text-align: center;"> <tr> <td style="width: 15%;">b15</td> <td style="width: 15%;">b8</td> <td style="width: 15%;">b7</td> <td style="width: 15%;">b0</td> </tr> <tr> <td>High order</td> <td colspan="3"> <table border="1" style="width: 100%; height: 20px;"> <tr> <td style="width: 15%;">Sign</td> <td style="width: 15%;"></td> <td style="width: 15%;"></td> <td style="width: 15%;"></td> </tr> </table> </td> </tr> <tr> <td>Low order</td> <td colspan="3"> <table border="1" style="width: 100%; height: 20px;"> <tr> <td style="width: 15%;"></td> <td style="width: 15%;"></td> <td style="width: 15%;"></td> <td style="width: 15%;"></td> </tr> </table> </td> </tr> </table>	b15	b8	b7	b0	High order	<table border="1" style="width: 100%; height: 20px;"> <tr> <td style="width: 15%;">Sign</td> <td style="width: 15%;"></td> <td style="width: 15%;"></td> <td style="width: 15%;"></td> </tr> </table>			Sign				Low order	<table border="1" style="width: 100%; height: 20px;"> <tr> <td style="width: 15%;"></td> <td style="width: 15%;"></td> <td style="width: 15%;"></td> <td style="width: 15%;"></td> </tr> </table>						
	b15	b8	b7	b0																		
High order	<table border="1" style="width: 100%; height: 20px;"> <tr> <td style="width: 15%;">Sign</td> <td style="width: 15%;"></td> <td style="width: 15%;"></td> <td style="width: 15%;"></td> </tr> </table>			Sign																		
Sign																						
Low order	<table border="1" style="width: 100%; height: 20px;"> <tr> <td style="width: 15%;"></td> <td style="width: 15%;"></td> <td style="width: 15%;"></td> <td style="width: 15%;"></td> </tr> </table>																					
[Numeric specification]		The current position is indicated as a 32-bit signed integer (unit: 0.01mm). It is treated as a positive number when the most significant bit is 0 or as a negative number when the most significant bit is 1.																				

4.4.2 Timing after Power ON

After conforming that the slider or rod is not contacting the mechanical end or transferred work is not interfering with peripheral equipment, start operation following the steps below.

- [1] Reset the emergency stop condition or put the motor drive power into a current-accessible state.
- [2] Supply of 24V DC of controller power supply: 24V terminal, 0V terminal on the power supply terminal block
When 24V DC is supplied in an emergency stop reset state, the controller is automatically put into the servo ON condition internally.
- [3] Initial setting of parameters (min.)
(Example) To change the feed speed during teaching:
Change the value of the parameter No. 35 (safety speed).
- [4] Set the optimum values in the fields of "Position," "Speed," "Acceleration," "Deceleration," etc., with the PC or teaching pendant.

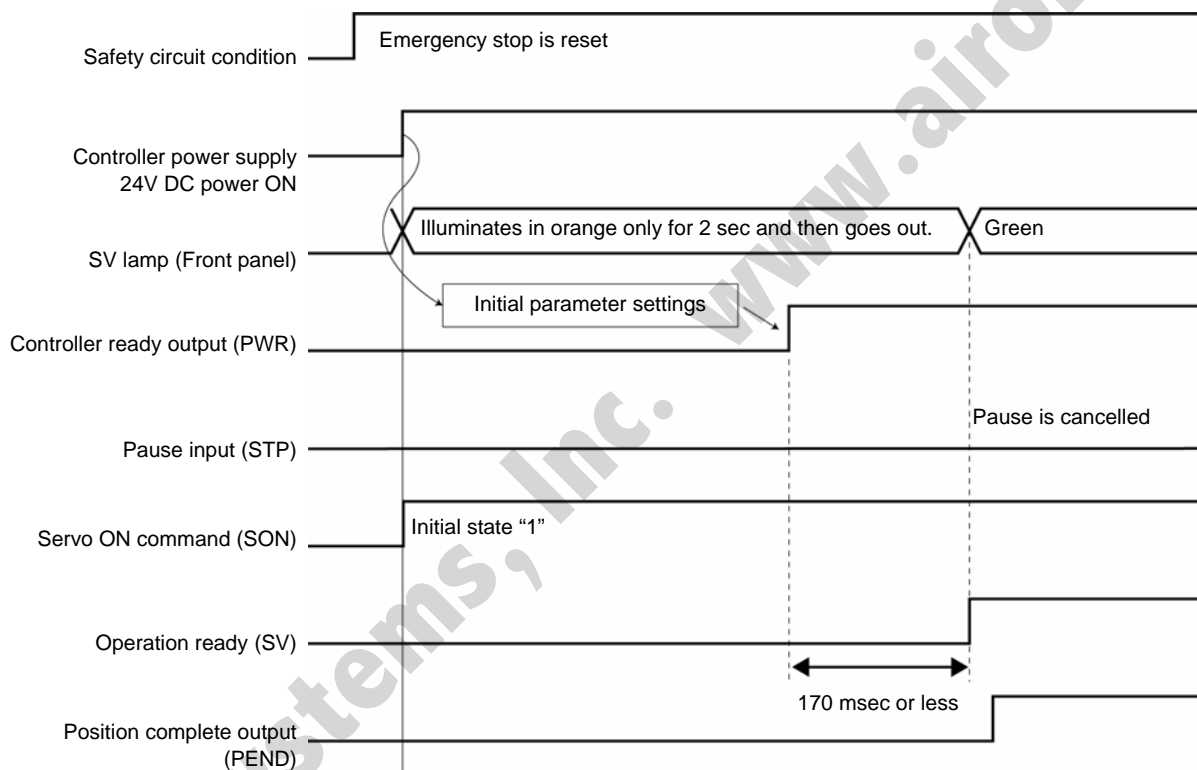

Caution: For the timing of emergency stop reset after power-on from the emergency stop condition, the servo will be turned ON in 170 msec at maximum after emergency stop reset.

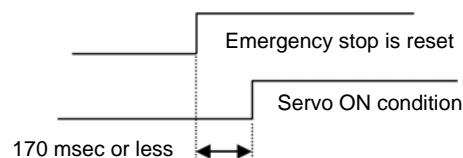

⚠ Warning: Since a pulse motor is adopted as a drive motor, magnetic pole phase detecting operation is performed in the first servo ON processing after power-on. Because of this, it becomes a condition that the actuator is ready when the servo is turned ON. If the slider or rod is contacting the mechanical end or transferred work is interfering with peripheral equipment, magnetic pole phase detecting operation may not be performed properly with abnormal operation or an excitation detection error occurring. In such cases, move the slider or rod to the actuator-movable position by hand before the servo is turned ON. If the actuator is equipped with a brake, it is required to turn ON the brake release switch to forcibly release the brake. At this time, exercise caution so as not to allow work to drop suddenly due to its own weight. Your hand may be caught by the dropped work or the robot hand or work itself may be damaged. If you cannot move the slider or rod, there is a method of changing parameter No. 28 (magnetic pole phase detecting direction). In this case, consult with IAI in advance.

- **Controller ready (PWR)**
This signal indicates whether the controller is controllable from the outside.
0: Controller BUSY, 1: Controller READY
The controller is not generally put into a BUSY status.
- **Servo ON command (SON)**
When this signal becomes "1," the servo ON status is made.
Use this signal when the servo ON/OFF is required in constructing the safety circuit of the entire equipment.
- **Operation ready (SV)**
This signal is a monitor signal indicating that the servo is ON and the motor is ready after the servo ON command (SON) is input. The 1/0 status of this signal is synchronized with the lit/unlit status of the SV lamp on the front panel.

4.4.3 Home Return Operation

Since this controller adopts the incremental position detector (encoder), mechanical coordinates will be lost if the power is cut off.

Because of this, it is required to establish the mechanical coordinates by performing home return operation immediately after power-on.

To perform home return operation, input the home return command (HOME).

Operation timing

PLC processing 1: When the start button is pressed, the home return command signal (HOME) turns ON.

Operation:

- [1] The actuator starts to move to the mechanical end near the home.
- [2] After hitting the mechanical end the actuator turns back, and stops temporarily at the home position.
→ The home return completion signal (HEND) turns ON.

PLC processing 2: The home return command signal (HOME) turns OFF.

PLC processing 3: Continuous operation starts.

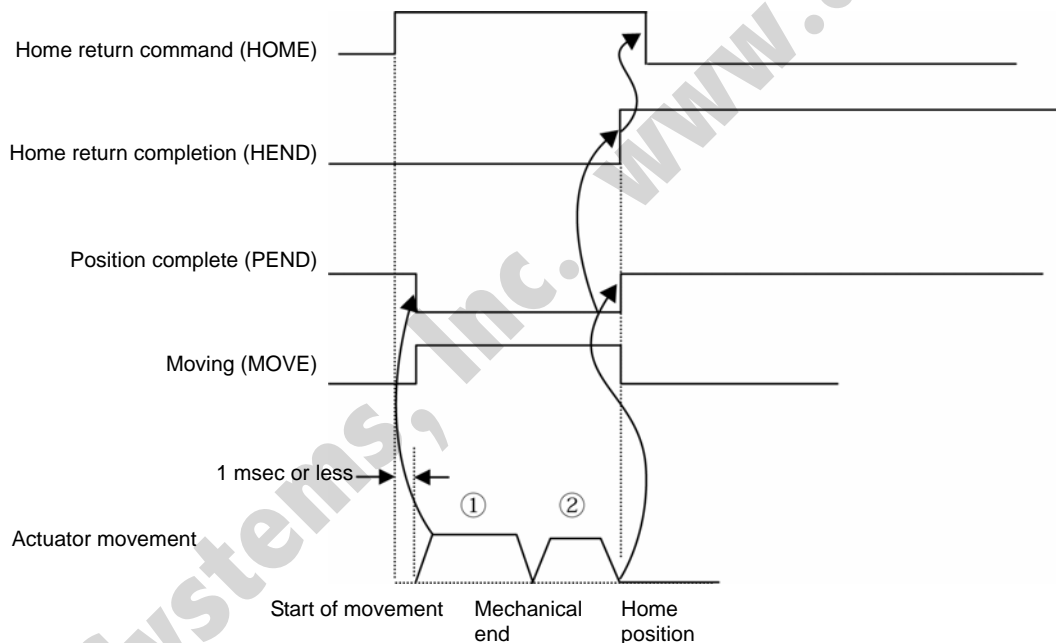

⚠ Caution: When performing home return operation, pay attention to the following:

- [1] Confirm that there is no obstacle located in the direction of home return.
- [2] Should there be an obstacle in the direction of home return, temporarily move the actuator in the home direction and remove the obstacle.
- [3] When the HOME signal is "1," the PEND signal becomes "0" and the MOVE output signal becomes "1."

Return the HOME signal to "0" after confirming that the HEND has become "1" while the HOME is "1."

■ Home return command (HOME)

When the rise edge (0→1) of this signal is detected, home return operation starts.

Upon completion of home return, the home return completion (HEND) signal will be output.

The HOME signal can be input any number of times even after the completion of home return.

(Note) Home return operation is automatically performed during the first positioning operation (CSTR signal) without performing home return after power-on.

■ Home return completion (HEND)

This signal is "0" immediately after the power is input, and becomes "1" in either of the following two conditions:

[1] Home return operation by the HOME signal has been completed.

[2] Home return operation associated with the first positioning operation by the CSTR signal has been completed.

Once this signal has become "1," it will not become "0" until the input power supply is cut off or the HOME signal is input again.

Use this signal as the interlock signal before home return.

4.4.4 Positioning Operation

First, turn on the 24V DC power supply and set so that the position complete signal (PEND) is "1" by referring to 4.4.2. Home return has not been completed immediately after the power is input. It is required to perform home return by issuing the home return command (HOME) as described in 4.4.3.

If positioning start (CSTR signal) is output by specifying a position (position no. specification or direct specification of position data), positioning will be performed to the specified position after performing home return operation.

Positioning operation is described below by taking the actuator with a stroke of 400mm as an example.

Example of position table

No.	Position [mm]	Speed [mm/s]	Acceleration [G]	Deceleration [G]	Push [%]	Positioning band [mm]	Comment
1	5.00	300.00	0.30	0.30	0	0.10	
2	200.00	300.00	0.30	0.30	0	0.10	
3	380.00	300.00	0.30	0.30	0	0.10	

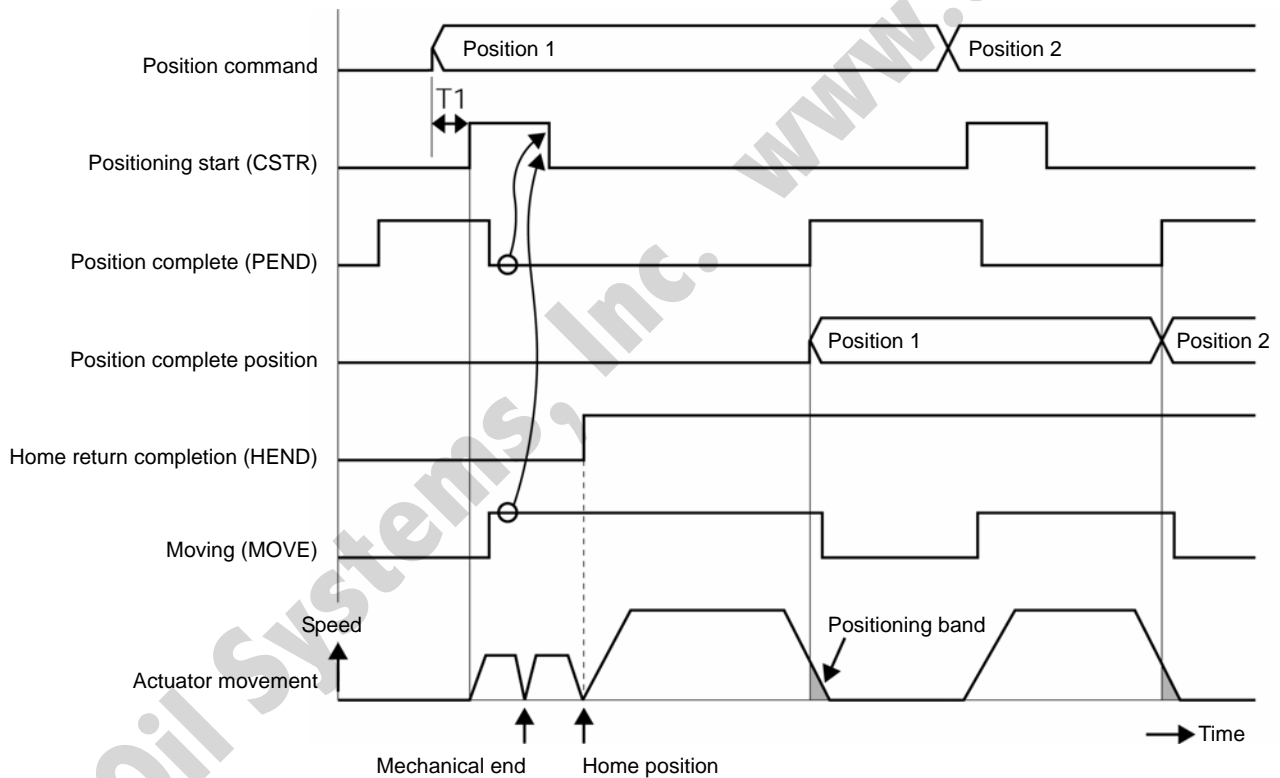

* T1: Set T1 to 0 msec or more in consideration of the scan time of the host controller.

Operational Description

- [1] If operation becomes ready after the voltage input, the operation ready (SV) and position complete (PEND) signals become "1." After confirming that PEND is "1," specify position 1 and set the positioning start signal (CSTR) to 1.
To specify a position, specify the position number as six bits from PC1 to PC32 or directly specify the numeric value in register PCMD.
→ Concurrently with the start of home return operation, PEND will become "0" and MOVE will become "1."
- [2] After confirming that MOVE has become "1," set CSTR to "0."
→ Immediately after the completion of home return operation (HEND will become "1"), positioning operation to position 1 will start.
- [3] When the set positioning band corresponding to the command value of position 1 is reached, PEND will become "1" (MOVE will become "0") and the completed position number will be output as six bits from PM1 to PM32 in register POSS.
- [4] Then, specify position 2 and set CSTR to "1" in the same ways as [1]. Positioning operation to position 2 will start.
- [5] Positioning to position 2 will be completed in the same way as [3].

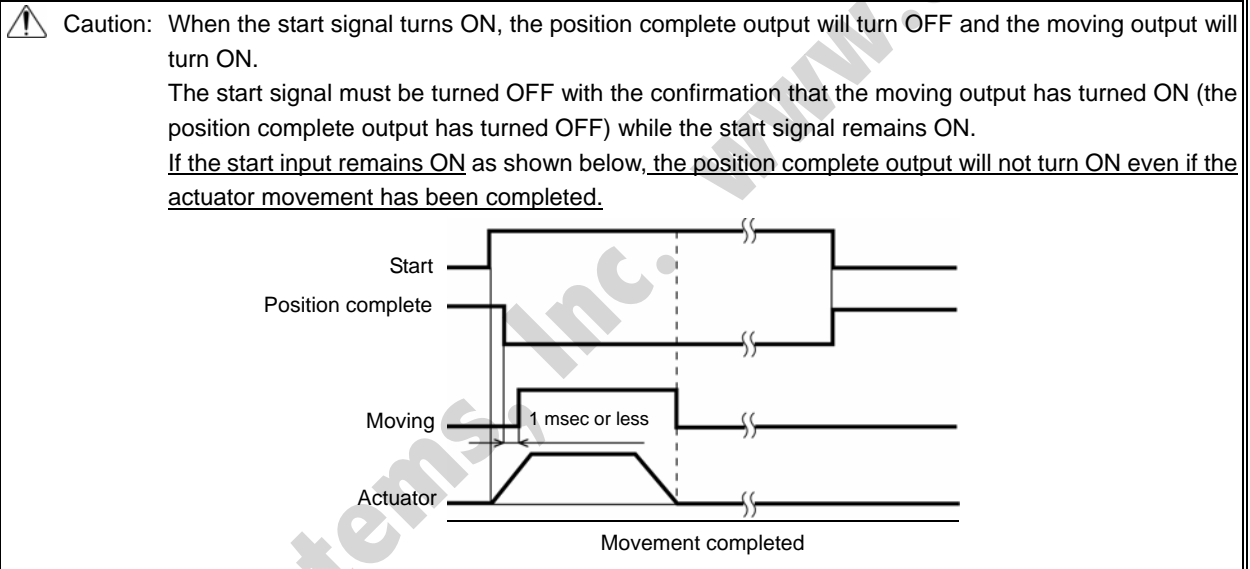

■ Positioning start (CSTR)

Upon detecting a rise edge (0→1) of this signal, the controller will read the target position number as a binary code consisting of six bits from PC1 to PC32 (position no. specification register), and execute positioning to the target position of the corresponding position data.

Before issuing a start command, all operation data such as the target position and speed must be set in the position table using the PC or teaching pendant.

If this command is issued when home return operation has not been performed yet after the power input (the HEND output signal is OFF), the controller will automatically perform home return operation before positioning to the target position.

■ Moving (MOVE)

This signal is output while the servo is ON and the actuator is moving (also during home return, push & hold operation or jogging).

Use the MOVE signal together with the PEND signal to allow the PLC to determine the actuator status.

The MOVE signal will become "0" when home return is completed and during a pause after a judgment is made during push & hold operation that the work is being contacted as well as when positioning is completed.

■ Command position number (PC1 – PC32)

When a movement command is effected upon 0 → 1 of the CSTR signal, the six-bit binary code consisting of signals PC1 to PC32 will be read as the command position number.

■ Completed position number (PM1 – PM32)

These signals can be used to check the completed position number when the PEND signal becomes "1."

The signals are output as a binary code in the position no. status register.

Immediately after the power is input, all of the PM1 to PM32 signals are "0."

All of PM1 to PM32 are also "0" when the actuator is moving.

As described above, this signal is output only when positioning is completed.

All of PM1 to PM32 will become "0" when the servo is turned OFF or an emergency stop is actuated. They will return to "1" when the servo is turned ON again, provided that the current position is inside the in-position band with respect to the target position. If the current position is outside the in-position band, the signals will remain at "0."

The signals will also become "1" when judgment is made as ON during push & hold operation or the work is not contacted.

■ Position Complete (PEND)

This signal indicates that the target position has been reached, and turns ON in the following condition:

- [1] The operation ready signal (SV) is "1" and
- [2] The current position deviation from each target position is within the positioning band or
- [3] Work is contacted (not missed) during push & hold operation.

This signal is used as a trigger signal to peripheral equipment when the target position is reached.

Since making the positioning band value larger quickens a command to peripheral equipment by that amount, it is effective as a means to reduce the tact time of the entire system.

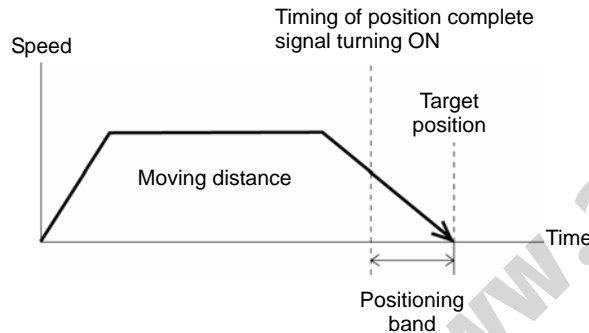

When the servo turns ON after the power is input, this signal will become "1" because that position becomes the target position. The signal will become "0" when positioning operation starts with the CSTR signal as "1."

(Note) When the servo turns OFF or an emergency stop is actuated, PEND will become "0" once.

If the position deviation is within the positioning band when the servo is turned ON again, PEND will return to "1." If CSTR remains "1," PEND will not return to "1" even when the current position deviation falls within the positioning band and become "1" after CSTR becomes "0."

4.4.5 Push & Hold Operation

The actuator can continue to hold work in position while the rod end is pushing it, like an air cylinder. Therefore, it can be used in the operation of work clamping or press fit process.

(1) Basic operation

After moving to the target position set as shown below, the actuator will move at the set push speed and push work by the push amount set as the maximum.

When a push force reaches a certain value in the middle of push & hold operation, the position complete signal will become "1" because push completion is judged with work being contacted.

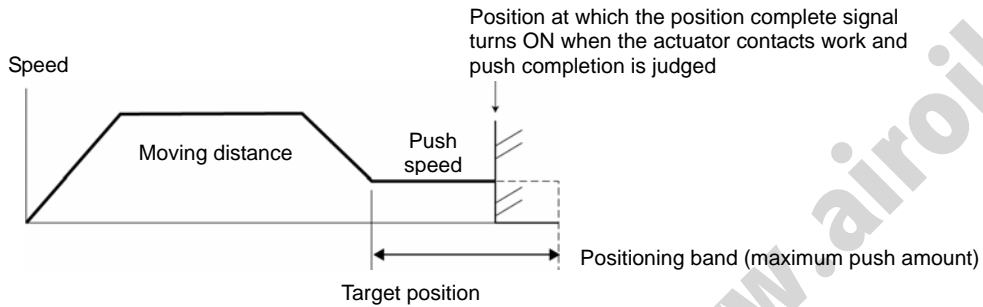

- Concept of push direction

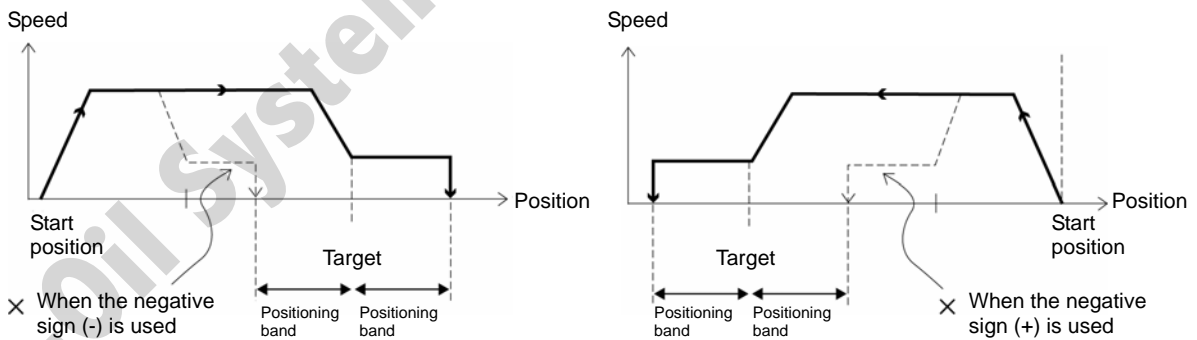
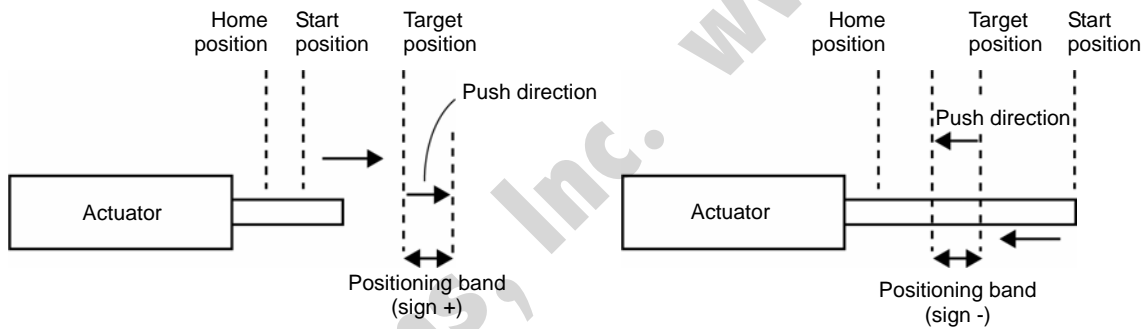

When work is pushed in the direction which increases the coordinate value from the start position toward the target position as shown above, the push direction will be positive (+). On the other hand, when work is pushed in the direction which decreases the coordinate value, the push direction will be negative (-). If the positioning band is entered with an incorrect sign, the position will deviate by twice the positioning band, as shown below. Therefore, exercise sufficient caution.

- [1] Push & hold mode
- Set a numeric value other than 0 in the "Push" field of the position table. (Current-limiting value)
 - In the case of numeric specification, specify "1" to bit 0 in the control flag specification register CTLF.
- [2] Push speed
- Set the push speed with parameter No. 34 (push speed).
(It is individually set on an actuator model basis before shipment.)
- [3] Maximum push amount
- Set the maximum push amount in the "Positioning band" field of the position table.
 - In the case of numeric specification, set it in the positioning band register (INP).
(Consider the position error when work is installed, or the depressed amount for work of elastic material.)
- [4] Push direction
- Sign of the "positioning band" in the position table
 - In the case of numeric specification, set "0" or "1" to bit 1 in the control flag specification register (CTLF).
- [5] Push complete judgment
- Push completion is judged with the motor generating torque (push force) and push time.
 - For the push force, set a current-limiting value (%) in the "Push" field of the position table. In the case of numeric specification, set the value in the push-time current-limiting value register (PPOW).
 - * Determine the push force according to the work characteristics (shape, material, etc.) and the current-limiting value according to the diagram for the relationship between the "push force and current-limiting value" of the actuator.
 - Set the value of the push stop judgment time to parameter No. 6.
(The factory setting is 255 msec.)

(2) Work is not contacted (missed)

If work is not contacted even though the actuator has moved the distance by the set positioning band (when the motor current does not reach the current-limiting value), the positioning complete signal will not be output. However, the completed position number will be output.

At this time, the PSFL bit of the device status register (DSS1) becomes "1."

Therefore, perform timeout check processing for sufficient time on the host PLC side.

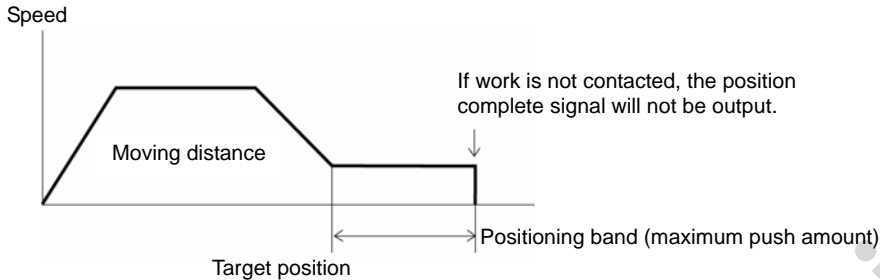

(3) Work moves during push & hold operation

(a) Work moves in the pushed direction

If work moves in the pushed direction after push & hold operation has once been completed, the actuator will push the work within the positioning band.

If the current during movement drops below the current-limiting value during push & hold, the position complete signal will turn OFF. The signal will turn ON again when the current rises to or above the limiting value.

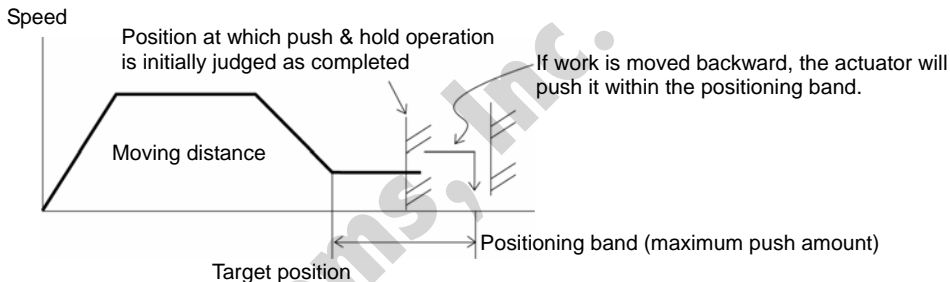

(b) Work moves in the opposite direction

(Actuator is pushed back by the reactive force of the work)

If the actuator is pushed back after push & hold operation has once been completed because the actuator thrust is smaller than the reactive force of the work, the actuator will be pushed back all the way until its thrust balances out with the reactive force of the work. At this time, the position complete signal will remain ON.

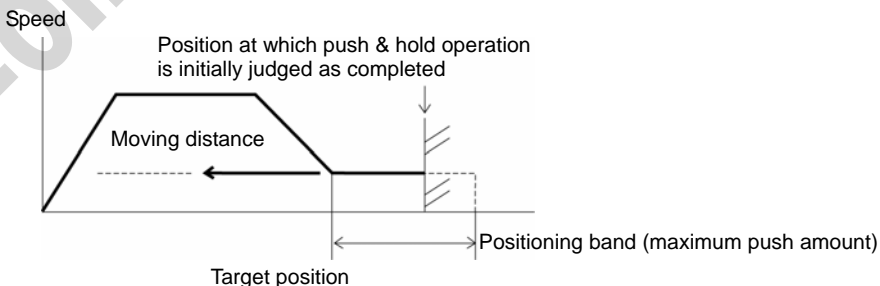

(Note) If the actuator is pushed back to the target position, an alarm will be generated.

(4) Positioning band is entered with an incorrect sign

If the positioning band is entered with an incorrect sign, the position will deviate by twice the positioning band, as shown below. Therefore, exercise sufficient caution.

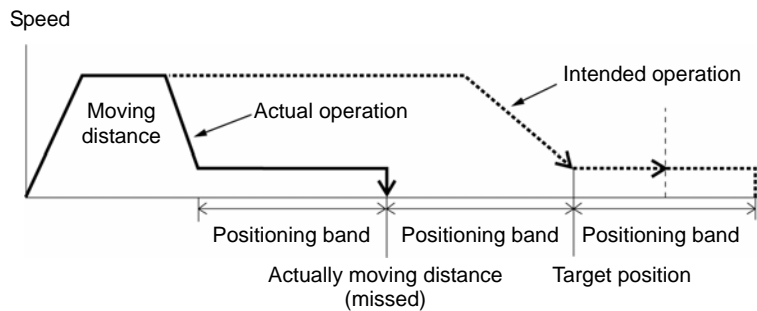

(5) Pushing back is performed after push & hold operation by specifying the relative coordinate

The reference position for the relative coordinate specification is not the current position at which the actuator stops after push & hold operation has completed but the target position of the position number for push execution. Exercise sufficient caution for this.

In the example above, if the position No. 2 is set as the relative coordinate minus 40mm, the actuator will move to the position of 240mm obtained by subtracting 40 from 280.

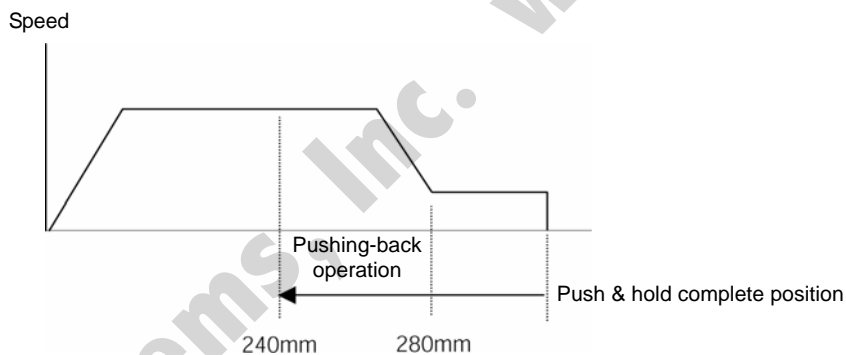

Air-Oil Systems Inc. www.airoil.com

The graphs below illustrate the relationship between the current-limiting value (%) and push force (N) for each actuator type.

● Slider type

(1) SA5C/SA6C/SS7C type

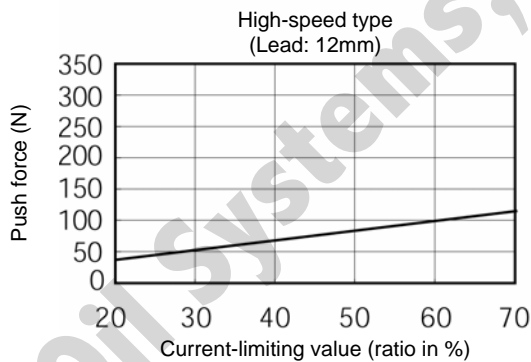
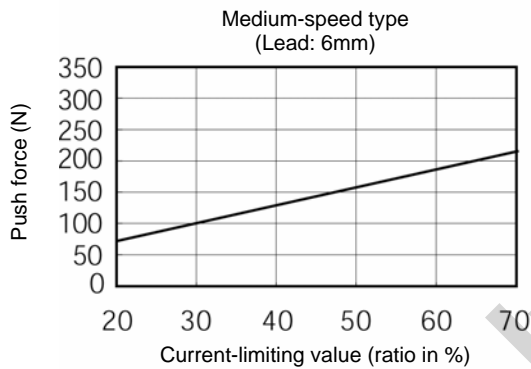
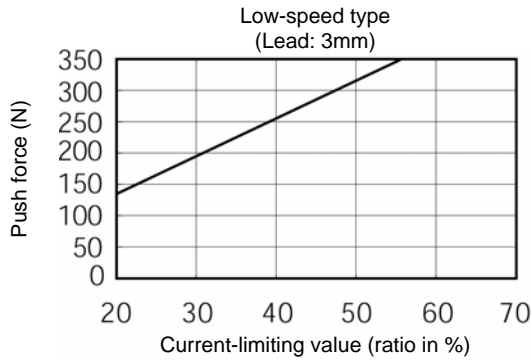

(2) SA7C type

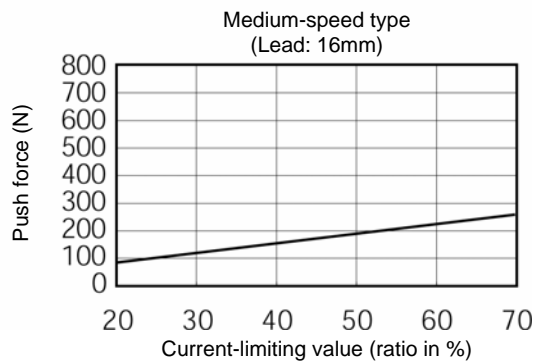
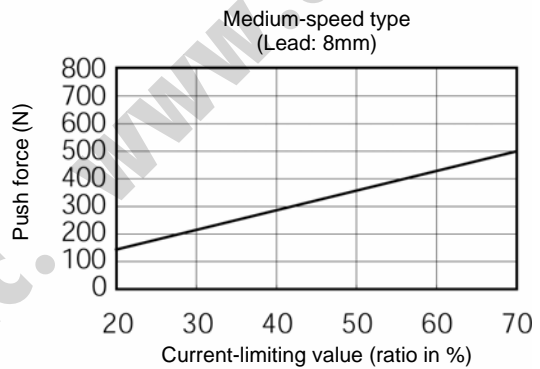
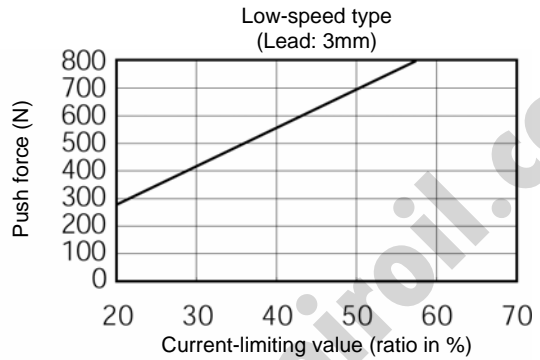

⚠ Caution: The accuracy of push force at standstill is not guaranteed. The above graphs are provided for reference purposes only.
If the push force is too small, malfunction may occur during push & hold operation due to slide operation, etc., so exercise caution.
The maximum current-limiting value is shown in the above graphs, the minimum value is 20%.

(3) SS8C type

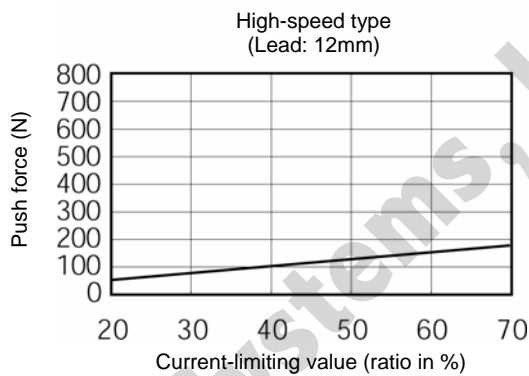
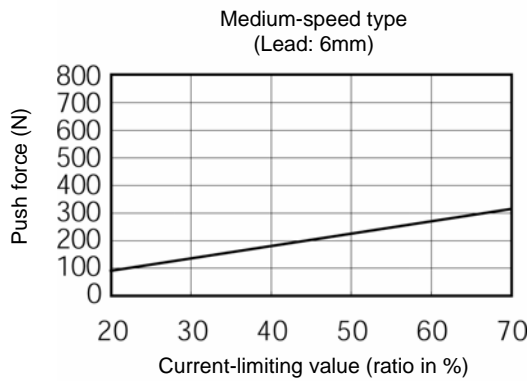
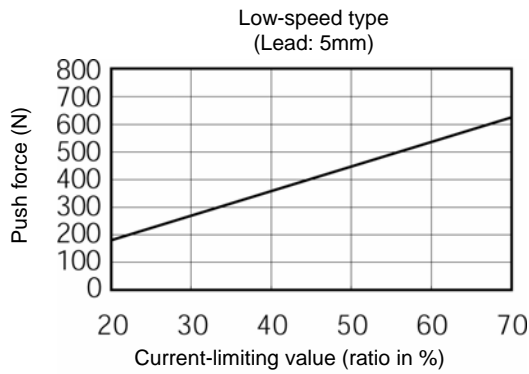

⚠ Caution: The accuracy of push force at standstill is not guaranteed. The above graphs are provided for reference purposes only.
 If the push force is too small, malfunction may occur during push & hold operation due to slide operation, etc., so exercise caution.
 The maximum current-limiting value is shown in the above graphs, the minimum value is 20%.

● Rod type

(1) RA2C type

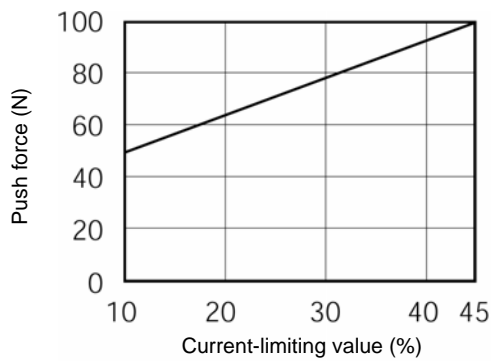

(2) RA3C type

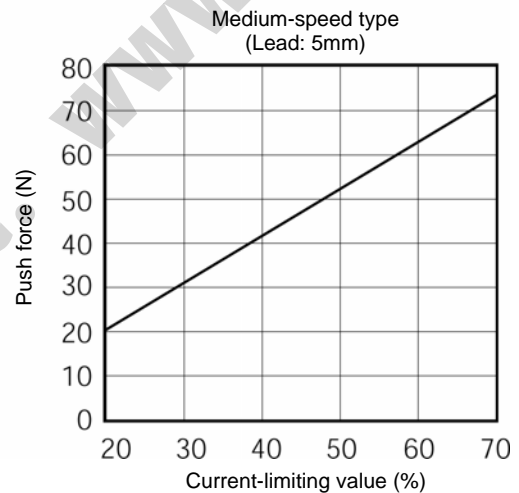
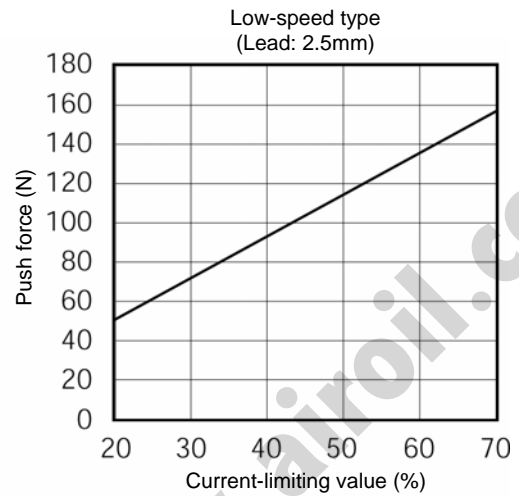

⚠ Caution: The accuracy of push force at standstill is not guaranteed. The above graphs are provided for reference purposes only.
 If the push force is too small, malfunction may occur during push & hold operation due to slide operation, etc., so exercise caution.
 The maximum current-limiting value is shown in the above graphs, the minimum value is 20%.

(3) RA4C type

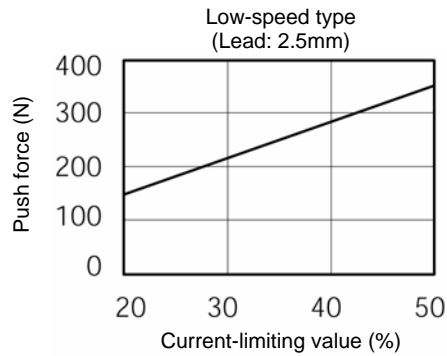

(4) RA6C type

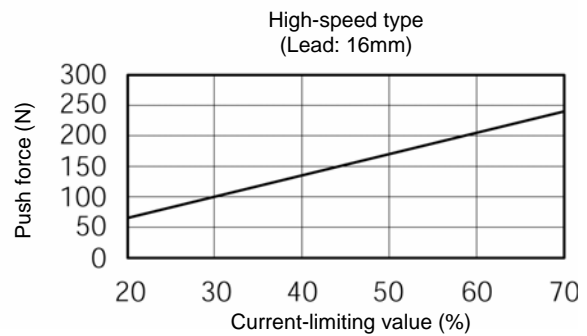
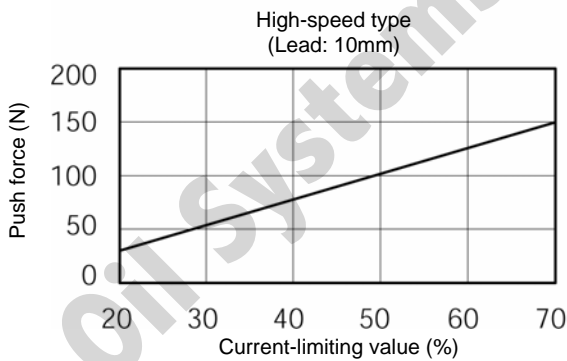
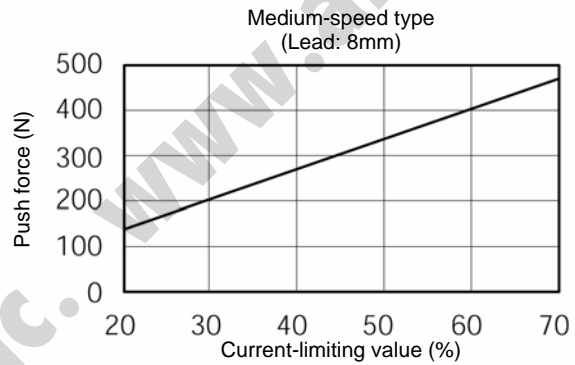
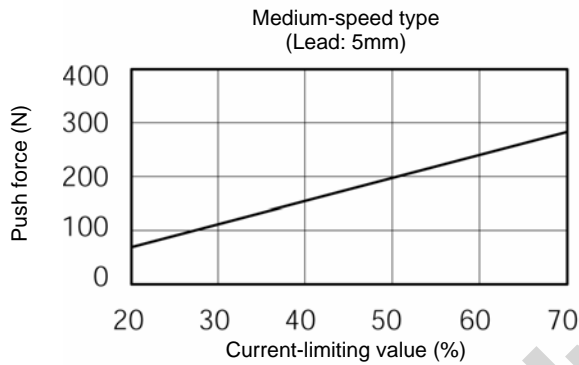
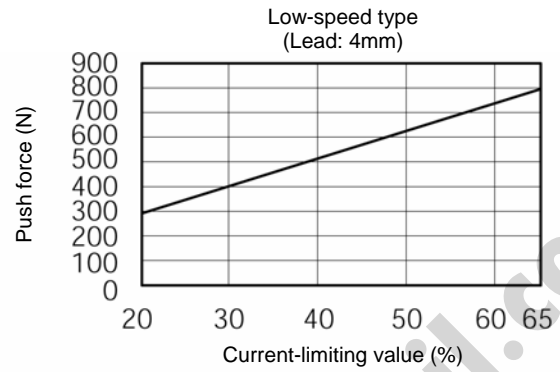

⚠ Caution: The accuracy of push force at standstill is not guaranteed. The above graphs are provided for reference purposes only.
If the push force is too small, malfunction may occur during push & hold operation due to slide operation, etc., so exercise caution.
The maximum current-limiting value is shown in the above graphs, the minimum value is 20%.

4.4.6 Pause

The actuator will decelerate to a stop by setting the pause command (STP) to "1" during its operation. Since the remaining movement is retained, setting STP to "0" again will restart the remaining movement.

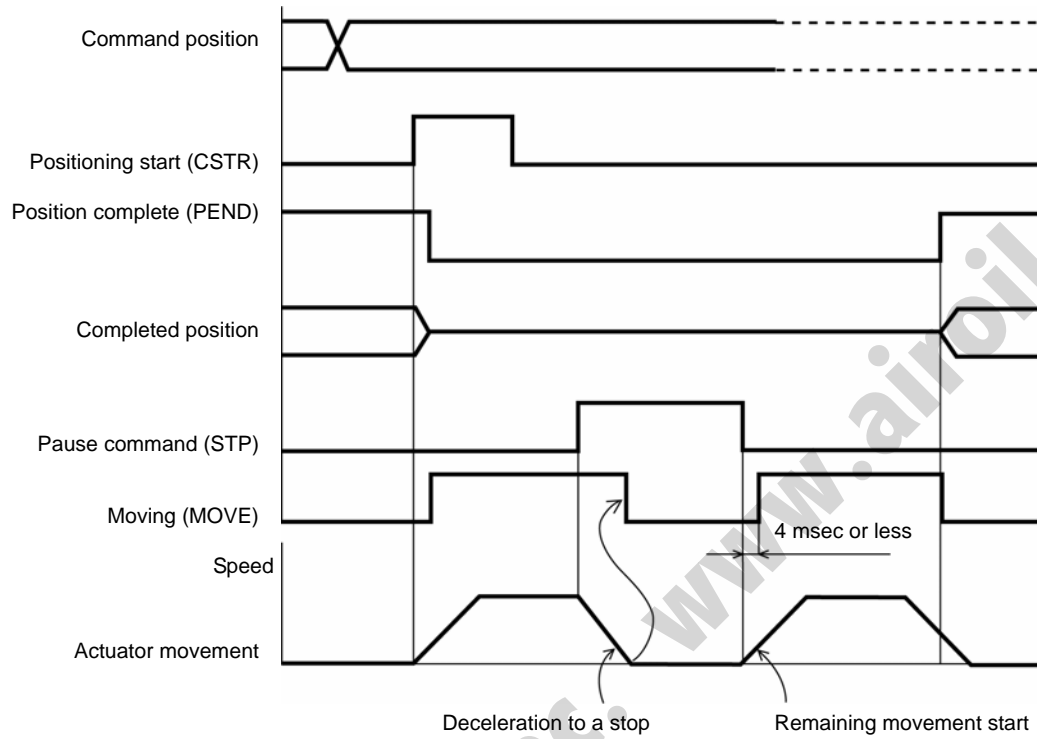

The remaining movement can be cancelled by setting the alarm reset (REC) to "1" during pause. (The controller will detect a rise of the reset signal and cancel the remaining movement.)

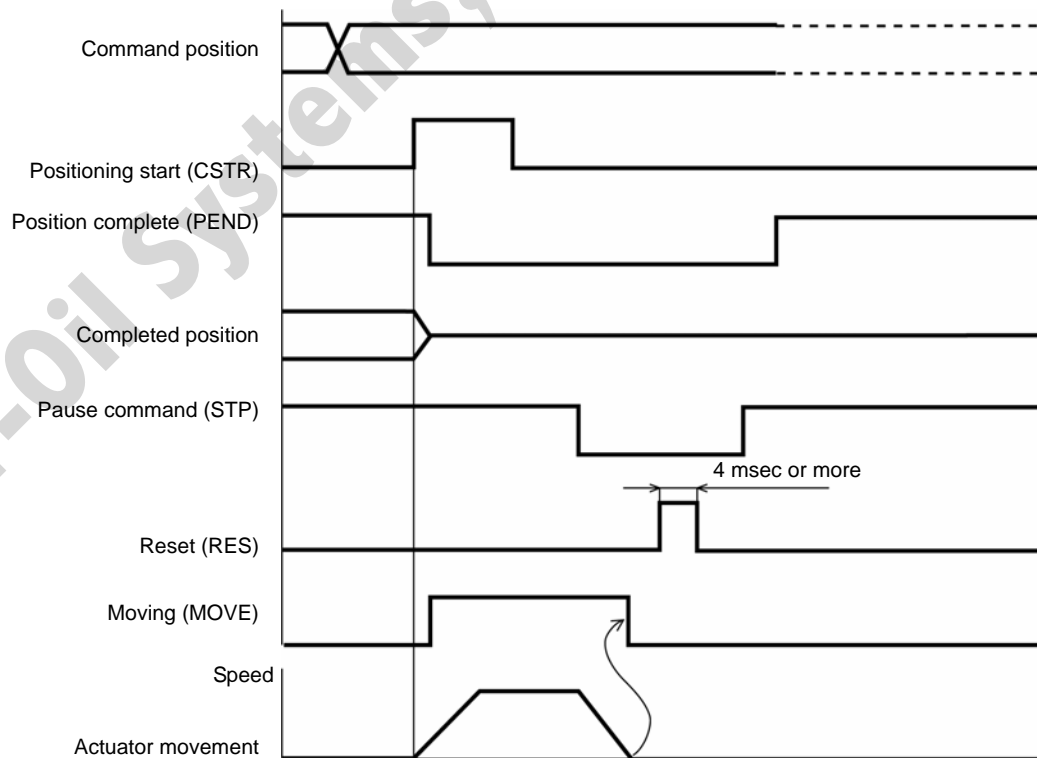

4.4.7 Speed Change during Movement

Speed control involving multiple speed levels is possible in a single operation. The actuator speed can be decreased or increased at a certain point during movement.

However, the position at which to implement each speed change must be set.



Applications refer to the case where the material of transferred work is soft or where it is not desired to give vibrations or an impact to the work having the easy-to-topple shape.

(Example) If positioning is performed at position 2 (300mm from the home position), move the actuator at a speed of 200 mm/sec up to position 1 in mid-process (200mm from the home position) and subsequently at a speed of 20 mm/sec.

Example of position table

No.	Position [mm]	Speed [mm/s]	Acceleration [G]	Deceleration [G]	Push [%]	Positioning band [mm]	Comment
1	*	*	*	*	*	*	
2	200.00	300.00	0.30	0.30	0	20.00	
3	380.00	20.00	0.30	0.30	0	0.10	

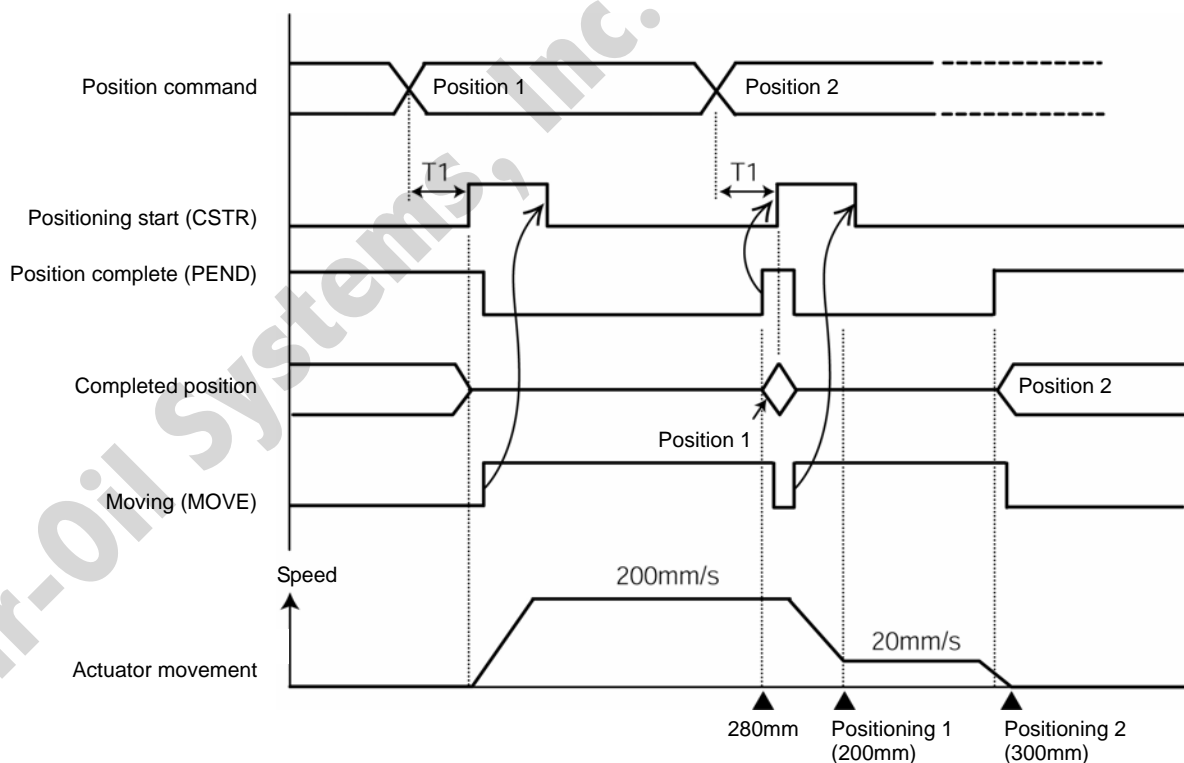

* T1: Set T1 to 0 msec or more in consideration of the scan time of the host controller.

P CON

(Note) If the pause command is output during home return operation, the movement command will be retained when the actuator has not pushed the mechanical end but operation must again begin with home return after the actuator has pushed the mechanical end and performed pushing-back operation.

■ Alarm reset (RES)

An alarm can be reset at a rise edge of 0 to 1.

If the cause for the alarm is not resolved, the alarm status will be entered again.

If an alarm is reset during pause, the remaining movement will be cancelled.

 Caution: [1] If the start signal (CSTR) is set to "1," the position complete signal (PEND) will be "0" and the moving signal (MOVE) will be "1."
Set the start signal (CSTR) to "0" after confirming that the moving signal (MOVE) has become "1" while CSTR is "1."
[2] If the positioning band at position 1 is made large, the actuator speed can be changed smoothly without stopping it temporarily.

4.4.8 Operation at Different Acceleration and Deceleration Settings

- (1) If the position no. specification mode is used, the acceleration and deceleration can be set separately in the position table.
- (2) If the numeric specification mode is used, the acceleration/deceleration data (set on register 9906H) will become valid during data receiving. Therefore, to make the deceleration different from the acceleration, change the acceleration/deceleration data during movement.

(Example)

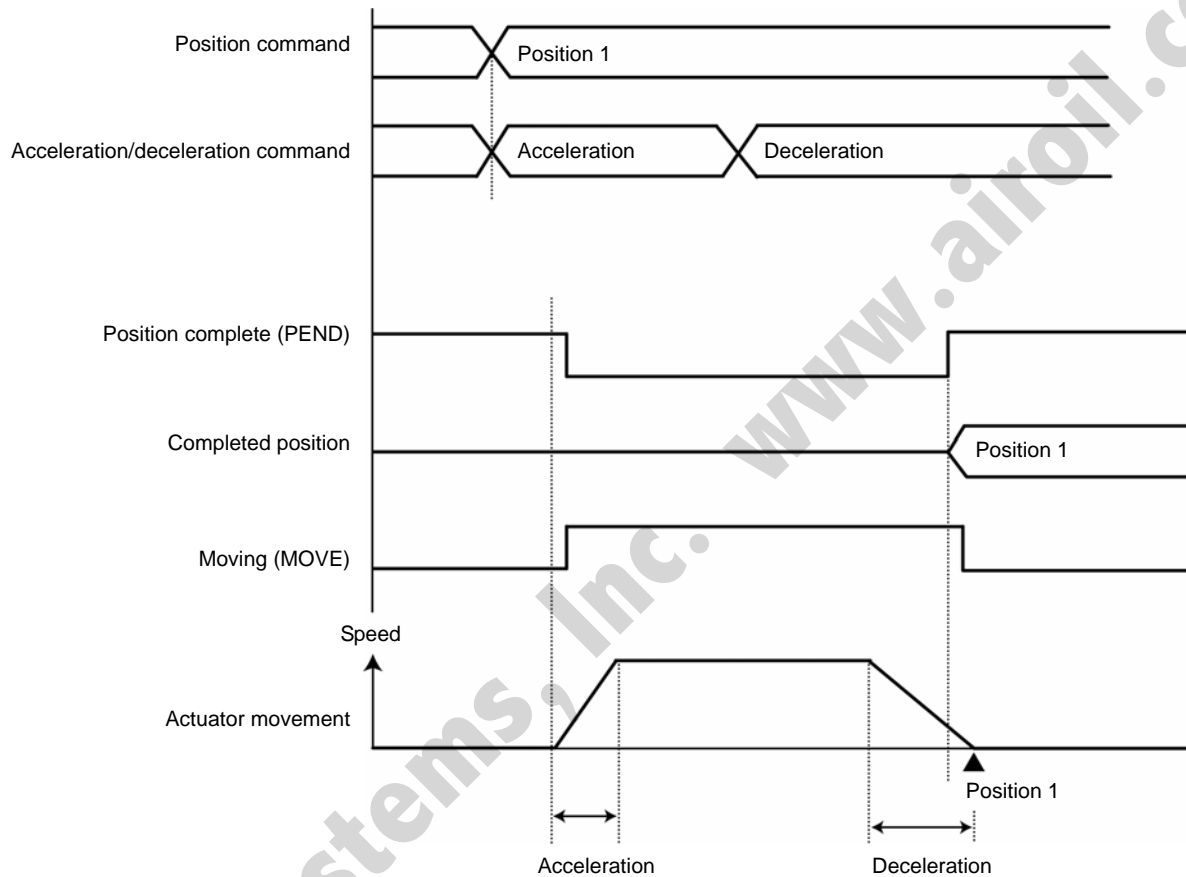

4.4.9 Zone Signal

This signal is output (becomes “1”) when the current position of the actuator is inside the set zone, and it can be used in the following application:

- [1] Interlock signal to prevent interference with peripheral equipment
- [2] Trigger signal to reduce the tact time for peripheral equipment
- [3] Judgment of work not being contacted during push & hold operation
- [4] End-point determination in constant pitch feeding of work placed in alignment

(Note) In the constant pitch feeding, the “Position” field of the position table indicates the relative amount but the zone setting establishes the absolute coordinate from the home position.

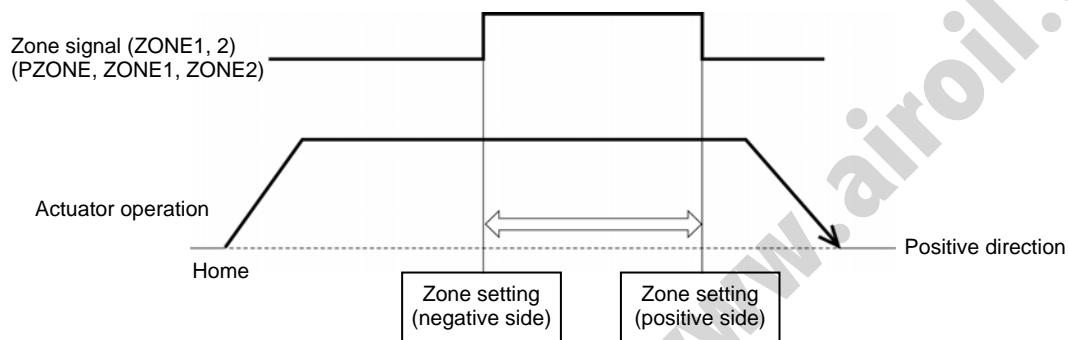

Setting	Zone signal	Position no. specification mode	Numeric specification mode
Individual zone boundary in position table	Position zone output PZONE	○	×
Zone boundary 1 of user parameter (parameter No. 1, No. 2)	Zone output 1 ZONE1	○	○
Zone boundary 2 of user parameter (parameter No. 23, No. 24)	Zone output 2 ZONE2	○	○

* The zone signal is output to the zone status register (address 9013H).

It becomes “1” when the current position is inside the zone range or becomes “0” when the current position is outside the zone range.

The signal becomes valid after the completion of home return. It is valid even when the servo is OFF, provided that home return has been completed.

4.4.10 Pitch Feeding by Relative Coordinate Specification

For the target position in the position table, relative coordinate specification is also available. Therefore, it can be used in constant-pitch positioning (constant-pitch feeding).

(1) Operation example in the position no. specification mode

The following is the description of an example of positioning with a 50-mm pitch from position No. 1. Create a position table as shown below. Operational completion is judged by PLC's executing count control. The combined use of the zone signal allows a double check.

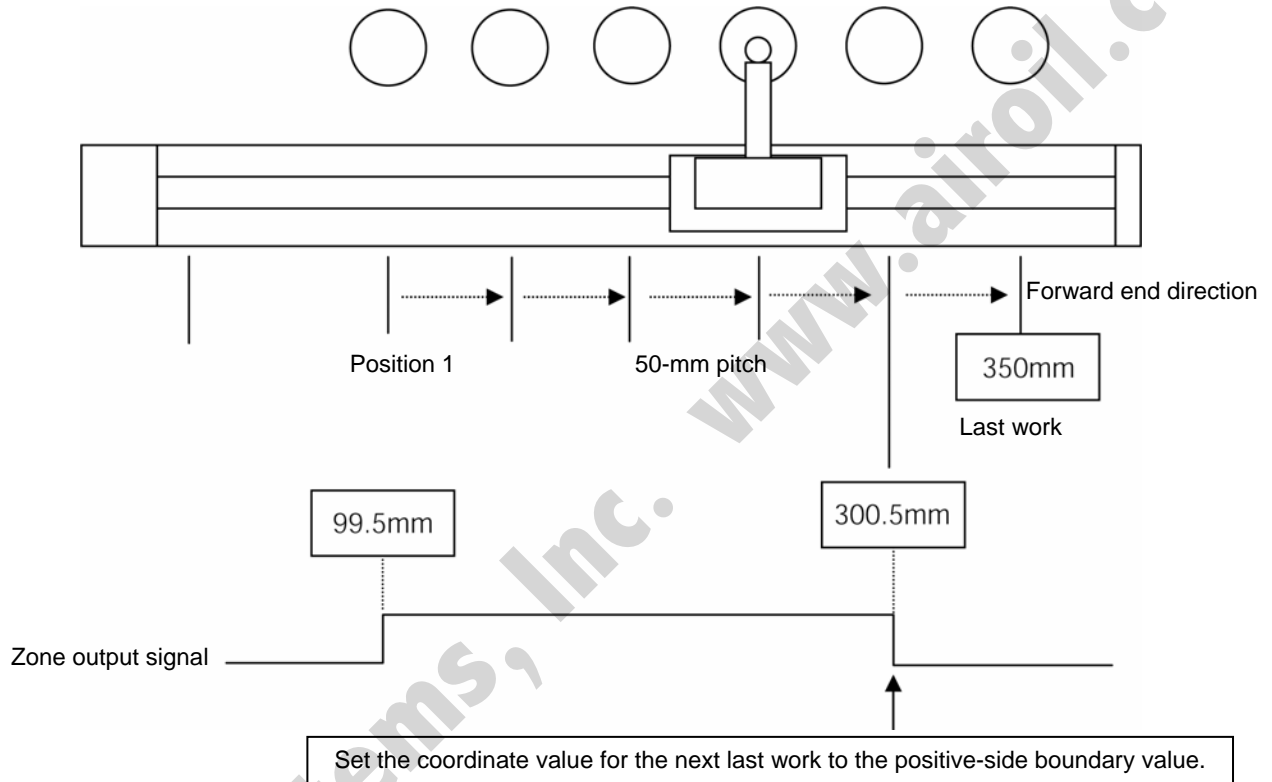

Example of position table

No.	Position [mm]	Zone + [mm]	Zone - [mm]	Incremental	Comment
0	*	*	*	0	
1	100.00	300.50	99.00	0	
2	50.00	300.50	99.00	1	

Indicates the relative coordinate specification with the teaching pendant.

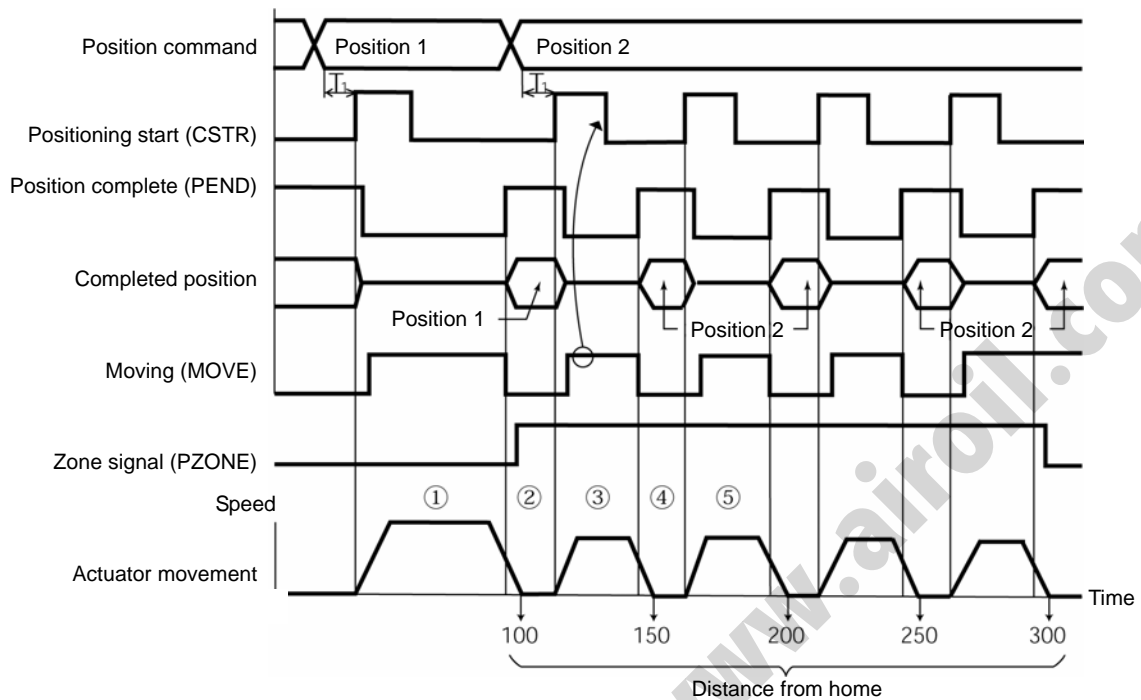

* T1: Set T1 to 0 msec or more in consideration of the scan time of the host controller.

[Operational description]

- [1] Perform positioning operation to position 1 (100.00mm).
- [2] Upon completion of positioning to position 1, the position complete signal (PEND) will become "1."
The zone signal (PZONE) will also become "1."
After changing the position number from 1 to 2, set the start signal (CSTR) to "1."
- [3] When movement starts, PEND will change from "1" to "0" and the moving signal (MOVE) will change from "0" to "1." After confirming that MOVE has become "1," set the start signal (CSTR) to "0."
- [4] When the actuator has moved only 50mm, PEND will become "1" and MOVE will become "0" again. At this time, the PLC counts the first time of movement.
Then, set the CSTR for the second 50-mm movement to "1."
- [5] Repeat the operations of [3] and [4].

The PLC checks the zone signal (PZONE) status when positioning has been completed and judges that the current position is the last work position if the signal has become "0."

If the number of counts on the PLC side does not agree with the zone signal status, it assumes that the signal timing is not synchronized.

(2) Notes on positioning operation

Selecting/entering a position number using relative coordinates during positioning will cause the actuator to move to the position corresponding to the initial position plus the relative movement. (If the relative movement is a negative value, the actuator will move to the position corresponding to the initial position minus the relative movement.)

Example) If the start signal for movement to position 2 is input while the actuator is moving to position 1, the actuator will move to the position 40mm from the home.

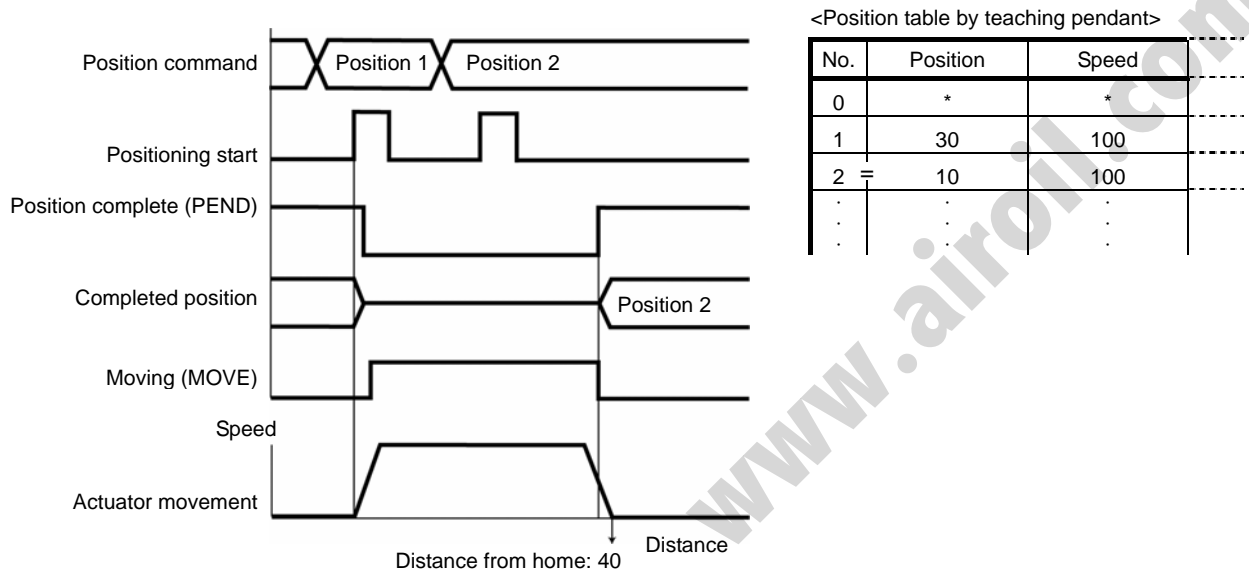

If the start signal for movement to a position number using relative coordinates is input multiple times during positioning, the actuator will move to the position corresponding to the initial position plus the relative movement \times number of times the signal was input.

Example) If the start signal for movement to position 2 is input twice while the actuator is moving to position 1, the actuator will move to the position 50mm from the home.

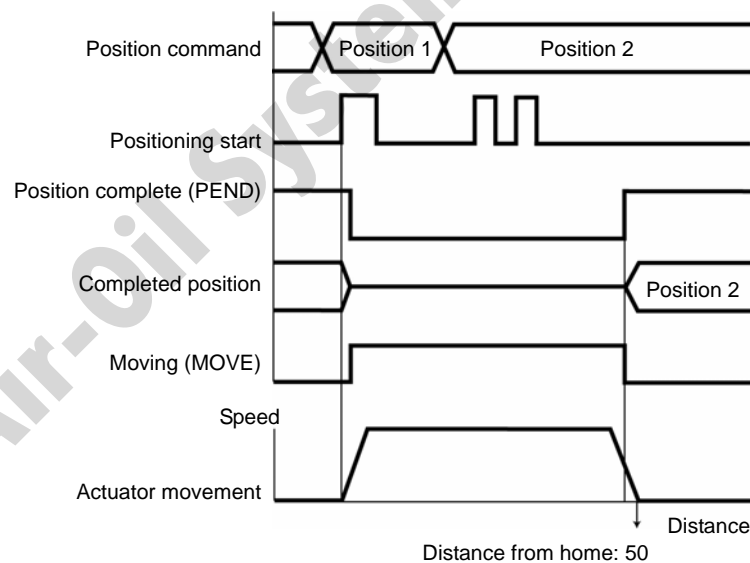

(3) Notes on push & hold operation

If the start signal is input with a position number using relative coordinates (push specification) selected/entered while the actuator is moving in the push & hold mode, the actuator will move to the position corresponding to the position at the time of start input plus the relative movement. Therefore, the end position will become indeterminate.

Example) If the start signal for movement to position 2 is input while the actuator is moving to position 1 in the push & hold mode, the actuator will move to the position 10mm from where it was when the input signal was input.

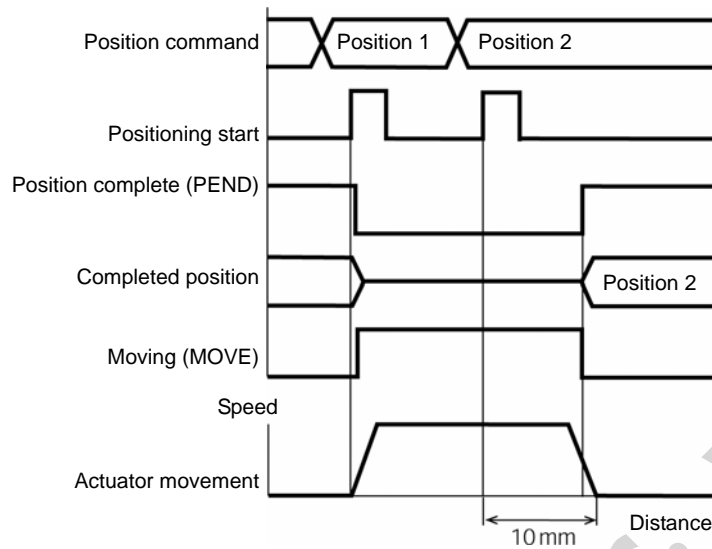

<Position table by teaching pendant>

No.	Position	Speed
0	*	*
1	50	100
2	10	100
.	.	.
.	.	.
.	.	.

4.4.11 Power Saving Method in the Standby Position

The general characteristics of the pulse motor include a larger holding current at standstill than the AC servo motor. Therefore, a method for reducing electric power consumption at standstill is prepared as part of energy-saving measures if stop time in the standby position is long.

Use this method after confirming that there is no problem with the entire equipment.

In the energy saving mode, the full servo control method can be selected in the following three conditions:

- (1) During standby in the servo ON status after power-on (before the completion of home return)
- (2) During standby in the home return completion status after home return operation by HOME input signal
- (3) During standby in the status of positioning completed to the target position

Set parameter No. 53 to 0 or 4.

	Set value
Invalid power saving method (complete stop status)	0
Full servo control method	4

■ Full servo control method

The holding current can be reduced by servo-controlling the pulse motor.

The degree of reduction varies depending on the actuator model, load condition, etc., but the holding current decreases by an approximate factor of 2 to 4.

No displacement occurs since this method maintains the servo ON status.

The actual holding current can be confirmed on the current monitoring screen of PC-compatible software.

However, micro vibrations or abnormal sounds may occur depending on the external force applied status or stop position. Should micro vibrations or abnormal sounds occur and cause a problem, do not use this method.

⚠ Warning: In the push & hold operation, the full servo control will be invalid if push & hold operation has been completed normally.
If operation has been completed with work not contacted, the full servo control method will become valid.

5. Parameter Settings

5.1 Parameter Table

Parameters are classified into four types according to their content.

- a: Parameter relating to the actuator stroke range
- b: Parameter relating to the actuator operating characteristics
- c: Parameter relating to the external interface
- d: Servo gain adjustment

No.	Category	Symbol	Name	Unit	Default factory setting
1	a	ZONM	Zone boundary 1+	mm	Effective actuator length
2	a	ZONL	Zone boundary 1-	mm	Effective actuator length
3	a	LIMM	Soft limit+	mm	Effective actuator length
4	a	LIML	Soft limit-	mm	Effective actuator length
5	a	ORG	Home return direction (0: Reverse/1: Forward)	—	(In accordance with the specification at the time of order)
6	b	PSWT	Push & hold stop judgment period	msec	255
7	d	PLG0	Servo gain number	—	Set individually in accordance with the actuator characteristics
8	b	VCMD	Default speed	mm/sec	Set individually in accordance with the actuator characteristics
9	b	ACMD	Default acceleration/deceleration	G	Set individually in accordance with the actuator characteristics
10	b	INP	Default positioning band (in-position)	mm	0.10
12	b	SPOW	Current-limiting value at standstill during positioning	%	35
13	b	ODPW	Current-limiting value during home return	%	100
16	c	BRSL	Serial communication speed	bps	38400
17	c	RTIM	Minimum delay time for slave transmitter activation	msec	5
22	a	OFST	Home return offset	mm	Set individually in accordance with the actuator characteristics
23	a	ZNM2	Zone boundary 2+	mm	Effective actuator length
24	a	ZNL2	Zone boundary 2-	mm	Effective actuator length
28	b	PHSP1	Default movement direction for excitation-phase signal detection (0: Reverse/1: Forward)	—	Set individually in accordance with the actuator characteristics
29	b	PHSP2	Excitation-phase signal detection time	msec	10
31	d	VLPG	Speed loop proportional gain	—	Set individually in accordance with the actuator characteristics
32	d	VLPT	Speed loop integral gain	—	Set individually in accordance with the actuator characteristics
33	d	TRQF	Torque filter time constant	—	Set individually in accordance with the actuator characteristics
34	b	PSHV	Push speed	mm/sec	Set individually in accordance with the actuator characteristics
35	b	SAFV	Safety speed	mm/sec	100
39	c	FPIO1	Position complete signal output method (0: PEND: 1: INP)	—	0 [PEND]
42	b	FPIO4	Enable function (0: Valid/1: Invalid)	—	1 (Invalid)
43	b	AIOF	Home position check sensor input polarity	—	(In accordance with the specification at the time of order)
45	c	SIVM	Silent interval magnification	times	0 (Invalid magnification)
46	b	OVRD	Speed override	%	100
53	b	CT;F	Default stop mode	—	0 [full stop]

(Note) The numbers are displayed on the PC software screen but not on the teaching pendant.

The missing numbers are not used and omitted.

The category codes are provided only for convenience and not displayed on either the PC software screen or teaching pendant.

5.2 Parameter Settings

If a parameter has been changed, always restart the controller using a software reset command or by reconnecting the power.

5.2.1 Parameters Relating to the Actuator Stroke Range

● Soft limit (No. 3/4 LIMM/LIML)

Set the soft limit in the positive direction in parameter No. 3, and that in the negative direction in parameter No. 4. The factory setting for the soft limits conforms to the effective actuator length. Change the settings, as necessary, to prevent collision with an obstacle or when the actuator must be stroked slightly beyond its effective length. An incorrect soft limit setting will cause the actuator to collide into the mechanical end, so exercise sufficient caution. The minimum setting unit is "0.01 [mm]."

(Note) To change a soft limit, set a value corresponding to 0.3mm outside of the effective range.

Example) Set the effective range to between 0mm and 80mm

Parameter No. 3 (positive side) 80.3

Parameter No. 4 (negative side) -0.3

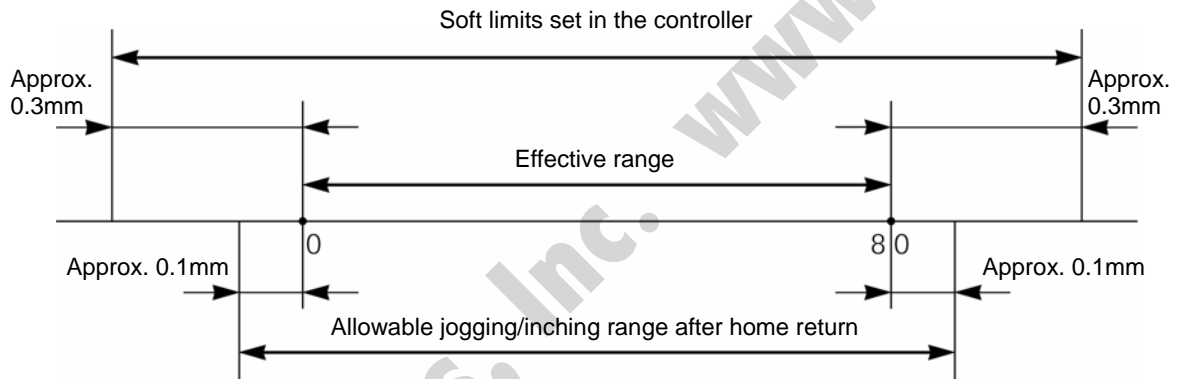

● Home return direction (No. 5 ORG)

Unless specified by the user, the home return direction is set to the motor direction at the factory. Should a need arise to change the home direction after the actuator has been assembled into your system, reverse the setting in parameter No. 5 between "0" and "1."

Also change the home return offset, soft limit and parameter in the excitation-phase signal detection direction, if necessary.

⚠ Caution: If the home direction is reversed, all position data that have been input will be retained.
The home direction cannot be reversed for the rod-type actuator.

● Home return offset (No. 22 OFST)

The controller is shipped from the factory with an optimal value set in parameter No. 22, so the distance from each mechanical end to the home becomes uniform.

The minimum setting unit is 0.01 [mm].

The home return offset can be adjusted in the following condition:

- [1] Want to align the actuator home and the system's mechanical home after the actuator has been assembled into the system
- [2] Want to set a new home after reversing the factory-set home direction
- [3] Want to eliminate a slight deviation generated after replacing the actuator

⚠ Caution: If the home return offset has been changed, the soft limit parameters must also be adjusted accordingly.

● Zone boundary (1: No. 1/2 ZONM/ZONL, 2: No. 23/24 ZNM2/ZNL2)

Set the zone in which a zone output signal (ZONE1 or ZONE2) will turn ON.

The zone signal turns ON only when the current coordinate position is inside the negative (-) boundary and positive (+) boundary settings.

The positive and negative boundaries for the ZONE1 signal are set in parameter No. 1 and No. 2, respectively.

The positive and negative boundaries for the ZONE2 signal are set in parameter No. 23 and No. 24, respectively.

The minimum setting unit is 0.01 [mm].

Example) Use ZONE1 as an intermediate limit switch inside 100 and 200mm, and use ZONE2 as a simple ruler inside 270 and 275mm, with an actuator having a 300-mm stroke

Parameter No. 1 (positive side) 200, parameter No. 2 (negative side) 100

Parameter No. 23 (positive side) 275, parameter No. 24 (negative side) 270

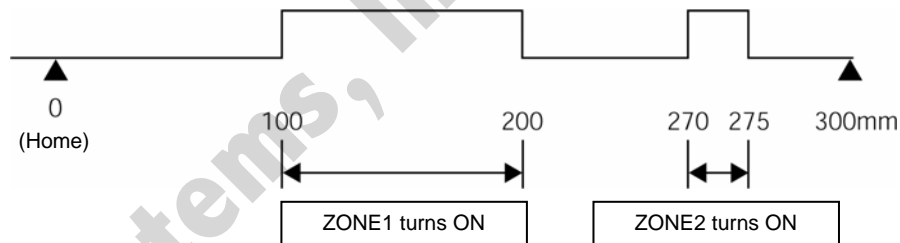

5.2.2 Parameters Relating to the Actuator Operating Characteristics

● Default speed (No. 8 VCMD)

The factory setting is the rated speed of the actuator.

When a target position is written to an unregistered position table or the current position is read in the teaching mode, the setting in this parameter will be used as the speed data for the applicable position number.

To reduce the default speed from the rated speed, change the setting in parameter No. 8.

● Default acceleration/deceleration (No. 9 ACMD)

The factory setting is the rated acceleration/deceleration of the actuator.

When a target position is written to an unregistered position table or the current position is read in the teaching mode, the setting in this parameter will be used as the acceleration/deceleration data for the applicable position number.

To reduce the default acceleration/deceleration from the rated acceleration/deceleration, change the setting in parameter No. 9.

● Default positioning band (in-position) (No. 10 INP)

The factory setting is "0.10 [mm]."

When a target position is written to an unregistered position table or the current position is read in the teaching mode, the setting in this parameter will be used as the positioning band data for the applicable position number.

Increasing the default positioning band will allow the position complete signal to be output early. Change the setting in parameter No. 10 as necessary.

● Current-limiting value during home return (No. 13 ODPW)

The factory setting conforms to the standard specification of the actuator.

Increasing this setting will increase the home return torque.

This setting need not be changed in normal conditions of use. However, if an increased slide resistance causes the home return to complete before the correct position depending on the fixing method, load condition or other factor when the actuator is used in a vertical application, the value set in parameter No. 13 must be increased.

(Do not increase the value beyond 75%)

● Current-limiting value at standstill during positioning

The factory setting conforms to the standard specification of the actuator.

Increasing this setting will increase the holding torque at standstill.

This setting need not be changed in normal conditions of use. However, to prevent hunting caused by large external force applied while the actuator is at standstill, the value set in parameter No. 12 must be increased.

(Do not increase the value beyond 70%.)

● Speed override (No. 46 OVRD)

Use this parameter to move the actuator to prevent danger at the trial run startup time.

When a movement command is issued from the PLC, an override can be applied to the movement speed set in the "Speed" field of the position table by the setting in parameter No. 46.

Actual movement speed = [Speed set in the position table] × [setting in parameter No. 46] ÷ 100

Example) Value in the "Speed" field of the position table: 500 (mm/s)

Setting in parameter No. 46: 20 (%)

In this case, the actual movement speed becomes 100 mm/s.

The minimum setting unit is 1% and the input range is 1 to 100 (%). The factory setting is 100%.

(Note) This parameter is invalid for the movement command by the PC or teaching pendant and the movement command by direct numeric specification.

In the case of the PC or teaching pendant, operation can be performed by setting a speed ratio on such a tool.

● Default movement direction for excitation-phase signal detection (No. 28 PHSP1)

Excitation-phase detection is performed at the first servo ON after the power is input. Define the detection direction at this time. This setting need not be changed in normal conditions of use. However, if the actuator contacts the mechanical end or an obstacle and cannot be moved by hand when the power is input, this setting must be changed to the direction in which the motor is easier to operate.

Set the value of parameter No. 28 to 0 or 1. If the detection direction is the same as the home return direction, set the same value as that in parameter No. 5 (home return direction).

To make this direction opposite the home return direction, set a value other than that in parameter No. 5 (home return direction).

(Example 1) Motor upper-side vertical installation + If the power is input when the slider is contacting the lower mechanical end:

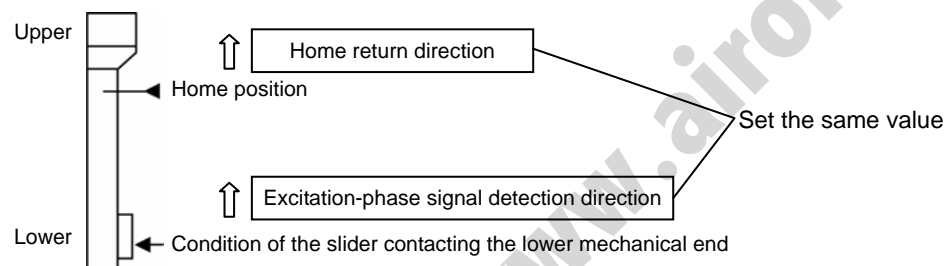

(Example 2) Motor lower-side vertical installation + If the power is input when the slider is contacting the lower mechanical end

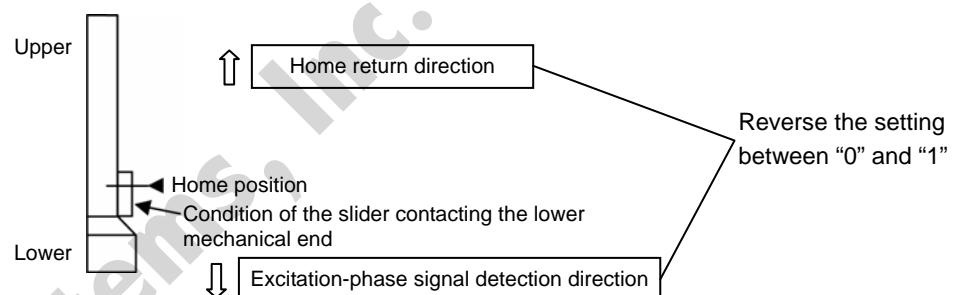

● Excitation-phase signal detection time (No. 29 PHSP2)

Excitation-phase detection is performed at the first servo ON after the power is input. Define the detection time at this time.

The factory setting is the detection time in accordance with the standard specifications of the actuator and this setting need not be changed in normal conditions of use.

Should an excitation detection error or a malfunction occur at the first servo ON after the power is input, the detection time set in parameter No. 29 can be changed as one of the remedies.

Before changing this parameter, contact us.

● Safety speed (No. 35 SAFV)

Define the feed speed for manual operation.

The factory setting is 100 mm/sec.

When changing the speed, set an optimal value to parameter No. 35.

However, the maximum speed is controlled to 250 [mm/sec]. Use the setting in this parameter as a slower speed than the maximum speed.

P_{CON}

- Default stop mode (No. 53 CTLF)

Define the power saving method if the actuator standby operation is long while the equipment is in operation. The presence or absence of execution is defined by parameter No. 53.

	Set value
Invalid power saving method	0
Full servo control method	4

Full servo control method

The holding current can be reduced by servo-controlling the pulse motor.

The degree of reduction varies depending on the actuator model, load condition, etc., but the holding current decreases by an approximate factor of 2 to 4.

No displacement occurs since this method maintains the servo ON status.

The actual holding current can be confirmed on the current monitoring screen of PC-compatible software.

Air-Oil Systems, Inc. www.airoil.com

● Push speed (No. 34 PSHV)

This meter defines the speed after the target position has been reached during push & hold operation.

The factory setting is the default value in accordance with the actuator characteristics.

Set an appropriate value in consideration of the material, shape, etc., of the work.

However, the maximum speed is controlled to 20 [mm/sec] even in the high-speed type although it varies depending on the actuator. Use the push speed as a slower speed than this maximum one.

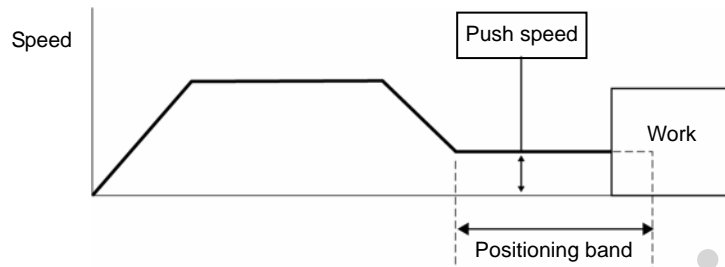

⚠ Caution: It is recommended to use the actuator at a speed of 5 mm/s or more to reduce the effect of variations in push speed.

● Push & hold stop judgment time (No. 6 PSWT)

This parameter is used as a judgment condition when determining if the work was contacted and the push & hold operation has been completed.

The push & hold operation is judged as completed if the current-limiting value set in the position table has been maintained for the period set in parameter No. 6.

Set an optimal value in consideration of the material, shape, etc., of the work, as well as the current-limiting value.

The minimum setting unit is 1 msec and the maximum judgment period is 9999 msec. The factory setting is 255 msec.

(Note) If the work has shifted and the current has changed during the push & hold judgment, the judgment follows the timing chart shown below. This example assumes a judgment period of 255 msec.

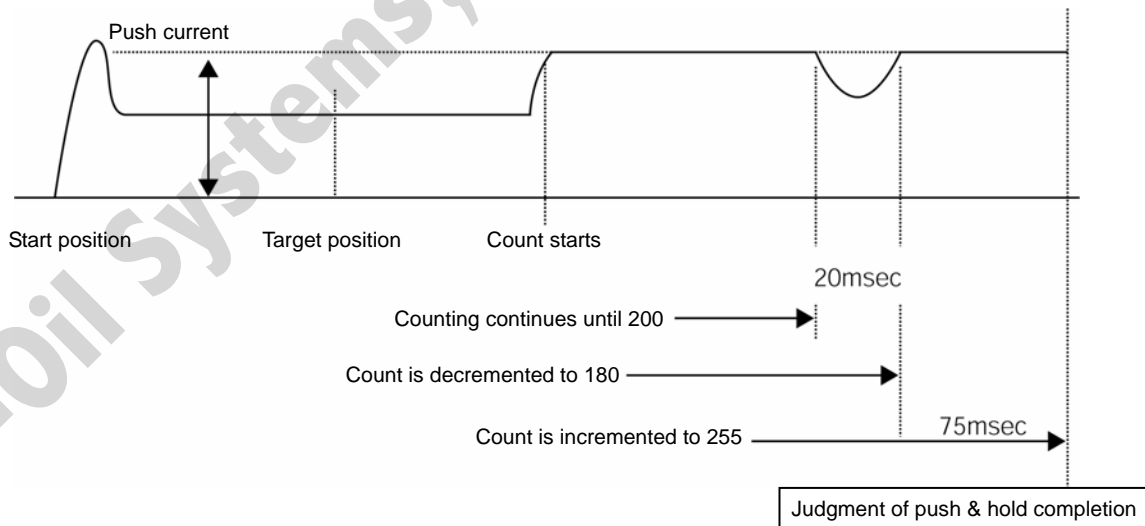

After reaching the push current, it is maintained for 200 msec. The current drops during the subsequent 20-msec period, and accordingly the count is decremented by 20. Therefore, when the operation is resumed the count will start from 180. Since the count will reach 255 after 75 msec at the push current, the controller will determine that the push & hold operation has been completed.

In this example, the total judgment period is 295 msec.

● Enable function (No. 42 FPIO4)

In ANSI-compliant teaching pendants, parameter No. 42 defines whether the deadman switch function is enabled or disabled.

* ANSI-compliant teaching pendants are to be developed in the future.

	Setting
Enable (use)	0
Disable (not use)	1

The factory setting is 1 [Disable].

● Home check sensor input polarity (No. 43 AIOF)

The controller is not equipped with a home check sensor as a standard, but it can optionally be installed.

It need not be changed normally, but change the value of parameter No. 43 if the system is changed by the customer after shipment.

Definition of setting: 0 (Standard specification, sensor not used)

1 (Home check sensor used, sensor polarity: contact a)

2 (Home check sensor used, sensor polarity: contact b)

[Operational description]

[1] When a home return command is issued, the actuator will hit the mechanical end, turn back, and then stop at the home position.

[2] If the home check sensor signal is changed when the controller stops, normal completion will be judged.

If the signal is not detected, the "home sensor non-detection error" will occur with the recognition of "displacement" and the alarm signal will be output.

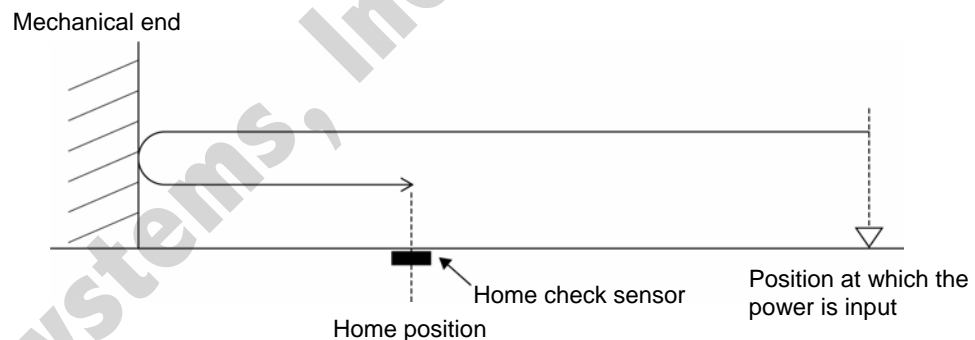

5.2.3 Parameters Relating to the External Interface

● Position complete signal output method (No. 39 FPIO)

Parameter No. 39 defines the condition of the position complete signal when the servo OFF condition or “deviation” occurs while the actuator has stopped under the positioning completed state.

From the viewpoint of the contents, this parameter is divided into the following two cases:

- [1] Where the current position deviates from the set “positioning band” value due to an external force applied during servo ON
- [2] Where the current position deviates from the set “positioning band” value due to an external force applied during servo OFF

The above is intended to offer flexibility to how the “position complete condition” is monitored in accordance with the equipment characteristics or the method of building a sequence circuit on the PLC side.

Especially when this parameter is used as is the case with the auto switch of the air cylinder, it is recommended to set 1 [INP].

The ON/OFF condition of the position complete signal becomes as follows in accordance with the setting in parameter No. 39:

Setting in Parameter No. 39	Description
0 [PEND]	<ul style="list-style-type: none"> [1] Servo ON condition The servo will remain ON even if the current position is outside the “positioning band” value range set with respect to the target position. [2] Servo On condition The servo will be OFF regardless of where the current position is.
1 [INP]	<p>The parameter will be ON if the current position is inside the “positioning band” value range set with respect to the target position, and will be OFF if the current position is outside the range, regardless of whether the servo is ON or OFF.</p> <p>* It is like an auto switch of the air cylinder.</p>

The factory setting is 0 [PEND].

● Serial communication speed (No. 16 BRSL)

Set the communication speed to be used when the control is performed via serial communication using the PLC’s communication module.

Set an appropriate value in parameter No. 16 in accordance with the specification of the communication module.

One of 9600, 19200, 38400, 115200, and 230400 bps can be selected as the communication speed.

The factory setting is 38400 [bps].

● Minimum delay time for slave transmitter activation (No. 17 RTIM)

This parameter defines the minimum delay time until the controller’s transmitter will be activated after completion of command reception, when serial communication is performed using the PLC’s communication module.

The factory setting is 5 msec, but another necessary delay time must be set in parameter No. 17 if the specification of the communication module exceeds 5 msec.

● Silent interval magnification (No. 45 SIVM)

This parameter applies to commands via RS485 serial communication.

It defines the magnification of the silent interval time in the delimiter judgment of the RTU mode.

The factory setting is based on the communication time of 3.5 characters in accordance with the Modbus specification.

This parameter need not be changed under normal operation by the PC or teaching pendant.

When the character transmission interval of the PLC with a strict scan time exceeds the silent interval, parameter No. 45 allows the extension of the silent interval time.

The minimum setting unit is 1 [times], and the input range is 0 to 10. When the setting in this parameter is 0, it indicates that this parameter is invalid.

5.2.4 Servo Gain Adjustment

Since servo adjustment is made in accordance with the standard specification of the actuator before shipment, this setting need not be changed in normal conditions of use.

However, because vibrations or abnormal sounds may be produced due to the affixing method of the actuator or loading conditions, parameters related to servo adjustment are released.

Especially custom-made items (the lead length of the ball screw is greater, stroke is longer, etc., than the standard items) may produce vibrations or abnormal sounds with the effect of external conditions.

In such cases, the parameters shown below need to be changed. Please contact IAI.

● Servo gain number (No. 7 PLG0)

Parameter No.	Unit	Input range	Default
7	5rad/sec	0 – 31	6

This parameter determines the response of the position control loop.

Increasing the setting in this parameter will enhance the response to the position command.

However, excessively increasing it facilitates producing overshoot.

Lower settings will deteriorate the response to the position command, which requires more time.

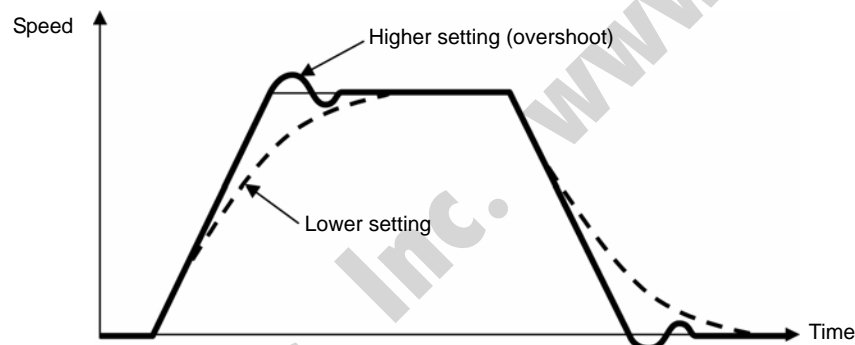

● Speed loop proportional gain (No. 31 VLPG)

Parameter No.	Unit	Input range	Default
31	—	1 – 27661	Individual setting in accordance with actuator characteristics

This parameter determines the response of the speed control loop.

Increasing the setting in this parameter will enhance the response to the position command. (The servo rigidity will be higher.)

The higher the load inertia becomes, the larger the value should be set.

However, excessively increasing the setting will cause overshooting or oscillation, which facilitates producing the vibrations of the mechanical system.

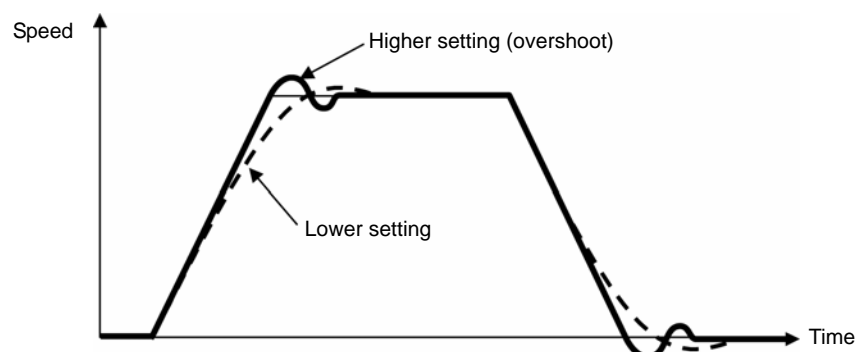

● Speed loop integral gain (No. 32 VLPT)

Parameter No.	Unit	Input range	Default
32	—	1 – 217270	Individual setting in accordance with actuator characteristics

This parameter determines the response of the speed control loop.

Increasing the setting in this parameter will decrease the response to the speed command. In addition, a repulsive force against the load change will be decreased.

Excessively decreasing the setting will cause overshooting or oscillation, which facilitates producing the vibrations of the mechanical system.

Lower settings will deteriorate the response to the position command, which requires more time.

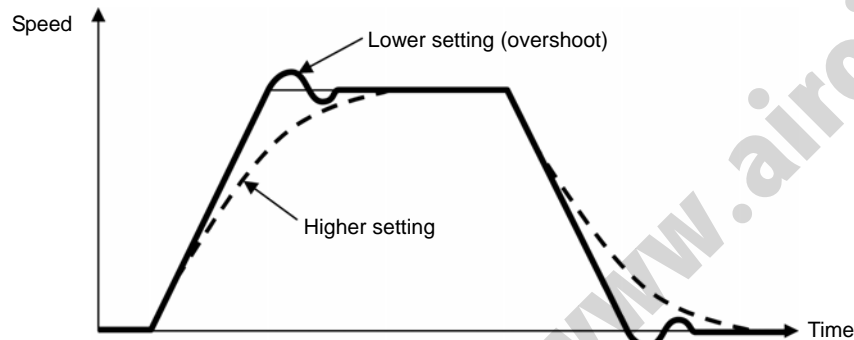

● Torque filter time constant (No. 33 TRQF)

Parameter No.	Unit	Input range	Default
33	—	1 – 2500	Individual setting in accordance with actuator characteristics

This parameter defines the filter time constant to the torque command.

If the resonant frequency of the machine equals to or less than the response frequency of the servo loop, the motor will generate vibrations.

Increasing the setting in this parameter will be able to suppress the resonance of this machine system.

However, excessively increasing the setting may impair the stability of the control system.

6. Troubleshooting

6.1 Action to Be Taken upon Occurrence of Problem

Upon occurrence of a problem, take an appropriate action in accordance with the procedure below in order to ensure speedy recovery and prevent recurrence of the problem.

- a) Check the status indicator lamps.
 SV (green): The servo is ON.
 ALM (red): An alarm is present, or an emergency stop has been actuated or the motor drive power is cut off.
- b) Check the host controller for errors.
- c) Check the voltage of the main 24V DC power supply.
- d) Check for an alarm.
 Confirm the details of the error on the PC or teaching pendant.
- e) Check the cables for connection error, disconnection or pinching.
 Before performing a continuity check, turn off the power (to prevent a runaway actuator) and disconnect the cables (to prevent accidental power connection due to a sneak current path).
- f) Check the I/O signals.
- g) Check the noise elimination measures (grounding, installation of a surge killer, etc.)
- h) Review the events leading to the occurrence of a problem, as well as the operating condition at the time of occurrence.
- i) Check the serial numbers of the controller and actuator.
- j) Analyze the cause.
- k) Take action.

Please check items a) through i) before contacting IAI.

(Reference) Lamp changes in each condition

	Servo OFF	Servo ON	Emergency-stop	Motor drive power is cut off
SV (green lamp)	Unlit	Lit	Unlit	Unlit
ALM (red lamp)	Unlit	Unlit	Lit	Lit

6.2 Alarm Level Classification

Alarms are classified into the following two levels in accordance with the symptoms they represent:

Alarm level	ALM lamp	Failure status register	What happens when alarm generates	How to reset
Operation cancellation	Lit (red)	ALMH is "1."	The actuator decelerates to a stop and then the servo turns OFF.	<ul style="list-style-type: none">- Reset the alarm by the PC/teaching pendant.- Input the reset signal from the PLC.
Cold start	Lit (red)	ALMH is "1."	The actuator decelerates to a stop and then the servo turns OFF.	<ul style="list-style-type: none">- Reset software by the PC/teaching pendant.- Reconnect the power.



Caution: Reset each alarm after identifying and removing the cause. If the cause of the alarm cannot be removed or when the alarm cannot be reset after removing the cause, please contact IAI. If the same error occurs again after resetting the alarm, it means that the cause of the alarm has not been removed.

6.3 Alarm Description and Cause/Action

(1) Operation-cancellation level alarms

Code	Error name	Cause/Action
080	Movement command during servo OFF	Cause: A movement command was issued by numeric specification while the servo was OFF. Action: Issue a movement command after confirming the servo is ON (SV or PEND is "1").
083	Numeric command during home return non-completion	Cause: Numeric specification of the absolute position was performed while home return was not yet completed. (No problem in the position no. specification mode) Action: Issue a movement command by numeric specification after performing home return operation and confirming the complete signal (HEND).
084	Movement command during home return	Cause: A movement command was issued by numeric specification during home return. Action: Issue a movement command after performing home return operation and confirming the complete signal (HEND).
085	Position No. error during movement	Cause: Unregistered position number was specified in the position table in the position no. specification mode. Action: Recheck the position table.
090	Soft reset during servo ON	Cause: A soft reset command was received while the servo was ON. Action: Send a soft reset command to the controller after confirming that the servo is OFF (SV is "0").

Code	Error name	Cause/Action
0A1	Parameter data error	<p>Cause: The data input range in the parameter area is not appropriate. (Example) This error occurs when the magnitude relationship is apparently inappropriate such as when 300mm was incorrectly input as the value of the soft limit negative side while the value of the soft limit positive side was 200.3mm.</p> <p>Action: Change the value to an appropriate one.</p>
0A2	Position data error	<p>Cause: [1] A movement command was issued when no target command was set in the "Position" field. [2] The value of the target value in the "Position" field exceeded the soft limit set value.</p> <p>Action: [1] Set the target position first. [2] Change the value of the target position to one within soft limit set values.</p>
0A3	Position command data error	<p>Cause: The speed or acceleration/deceleration value during numeric specification exceeded the maximum set value.</p> <p>Action: Change the value to an appropriate one.</p>
0BA	Home sensor non-detection	<p>This alarm indicates that the actuator with a home sensor used did not normally complete home return operation.</p> <p>Cause: [1] Work is interfering with peripheral equipment in the middle of home return. [2] The slide resistance of the actuator is locally high. [3] Installation failure, breakdown or disconnection of the home check sensor</p> <p>Action: If the work is not interfering with peripheral equipment, the cause of [2] or [3] is suspected. Please contact IAI.</p>
0BE	Home return timeout	<p>Cause: Home return is not completed within the period set in the applicable system parameter after the start of home return operation. (This alarm will not be generated in normal operation.)</p> <p>Action: The combination of the controller and actuator may be incorrect. Please contact IAI.</p>
0C0	Excessive actual speed	<p>Cause: This alarm indicates that the motor speed exceeded the maximum speed set in the applicable system parameter. This alarm will not be generated in normal operation, but may occur in the following condition: [1] The slide resistance of the actuator is locally high. [2] Instantaneous increase in load due to application of external force, which may cause the load to decrease and actuator to move rapidly before a servo error is detected.</p> <p>Action: Check the assembly condition of mechanical parts for abnormality. If the actuator itself is suspected to be the cause, please contact IAI.</p>

Code	Error name	Cause/Action
0C1	Servo error	<p>This alarm indicates that after receiving a movement command the motor is unable to operate for two seconds or more before reaching the target position.</p> <p>Cause: [1] Loose or disconnected motor-relay cable connector [2] Brake cannot be released on a controller equipped with a brake. [3] Large load due to application of external force [4] Large slide resistance of the actuator itself</p> <p>Action: [1] Check the wiring condition of the motor relay cable. [2] Check the wiring condition of the brake cable, and also turn on/off the brake release switch to see if the brake makes a “clicking” sound. [3] Check for abnormality in the assembly condition of mechanical parts. [4] If the load is normal, cut off the power and move the actuator by hand to check the slide resistance. If the actuator is suspected to be the cause, please contact IAI.</p>
0CA	Overheating	<p>This alarm indicates that the temperature around the power transistor in the controller is too high (95°C or higher).</p> <p>Cause: [1] High temperature around the controller [2] Faulty part inside the controller</p> <p>Action: [1] Lower the ambient temperature of the controller. If taking action in [1] does not solve the problem, please contact IAI.</p>
0CC	Abnormal control supply voltage	<p>This alarm indicates that the voltage of the 24V input power supply is excessive (24V+20%: 28.8V or more).</p> <p>Cause: [1] High voltage of 24V input power supply [2] Faulty part inside the controller</p> <p>Action: Check the voltage of the input power supply. If the voltage is normal, please contact IAI.</p>
0CE	Drop in control supply voltage	<p>This alarm indicates that the voltage of the 24V input power supply has dropped (24V-20%: 19.2V or less).</p> <p>Cause: [1] Low voltage of the 24V input power supply [2] Faulty part inside the controller</p> <p>Action: Check the voltage of the input power supply. If the voltage is normal, please contact IAI.</p>

(2) Cold-start level alarms

Code	Error name	Cause/Action
0B8	Pole sense error	<p>This controller will conduct excitation phase detection when the servo is first turned ON after the power has been input. This alarm indicates that the specified encoder signal level cannot be detected after 100ms of excitation.</p> <p>Cause: [1] Loose or disconnected motor-relay cable connector [2] Brake cannot be released on a controller equipped with a brake. [3] Large motor load due to application of external force [4] Power was input when the actuator was contacting a mechanical end. [5] Large slide resistance of the actuator itself</p> <p>Action: [1] Check the wiring condition of the motor relay cable. [2] Check the wiring condition of the brake cable, and also turn on/off the brake release switch to see if the brake makes a "clicking" sound. [3] Check for abnormality in the assembly condition of mechanical parts. [4] Move the actuator away from the mechanical end and then reconnect the power. [5] If the load is normal, cut off the power and move the actuator by hand to check the slide resistance.</p> <p>If the actuator is suspected to be the cause, please contact IAI.</p>
0D8	Deviation overflow	<p>The position deviation counter has overflowed.</p> <p>Cause: [1] The speed dropped during movement due to the effect of an external force, etc. [2] The excitation detection operation after power on is unstable.</p> <p>Action: [1] Check the load conditions, such as whether the load is contacting a surrounding object or the brake is released, and then remove the cause. [2] An overload condition is suspected, so review the load weight. Reconnect the power and then perform home return.</p>
0E8	Phase-A/B disconnection detection	<p>Encoder signals cannot be detected correctly.</p> <p>Cause: [1] Loose or disconnected encoder-relay cable connector [2] Loose or disconnected actuator-end connector of the supplied cable [3] If a high-thrust rod-type actuator is used together with an actuator of other type, the encoder relay cables may be connected incorrectly.</p> <p>Action: Check the connection condition of the encoder relay cable and conduct a continuity check. If the results are normal, please contact IAI.</p> <p>If [3] is suspected, check the model numbers of the encoder relay cables and connect the relay cables correctly. Cable for high-thrust rod type: CB-RFA-PA*** Cable for other actuator type: CB-RCP2-PA***</p>
0E9	Phase-A disconnection detection	
0EA	Phase-B disconnection detection	

Code	Error name	Cause/Action
0F4	Mismatched PCB	<p>This controller has a different motor drive circuit in accordance with the motor capacity. Therefore, a mounted motor is determined based on the printed circuit board (PCB).</p> <p>To this end, it is checked in the initialization process after starting whether the motor type set in the applicable system parameter matches the board.</p> <p>The alarm indicates that the motor type does not match the board.</p> <p>Cause: A parameter input error or board assembling error is suspected.</p> <p>Action: Should this error occur, please contact IAI.</p>
0F5	Nonvolatile memory write verify error	<p>When data is written in the nonvolatile memory, the written data is read once for a check to verify the data matching.</p> <p>This alarm indicates that the written data is not matching.</p> <p>Cause: [1] Faulty nonvolatile memory [2] The memory has been rewritten more than 100,000 times. (The nominal rewrite limit of the nonvolatile memory is around 100,000 times.)</p> <p>Action: If the alarm is generated again after reconnecting the power, please contact IAI.</p>
0F6	Nonvolatile memory write timeout	<p>This alarm indicates that no response was made when data was written in the nonvolatile memory.</p> <p>Cause: [1] Faulty nonvolatile memory [2] The memory has been rewritten more than 100,000 times. (The nominal rewrite limit of the nonvolatile memory is around 100,000 times.)</p> <p>Action: If the alarm is generated again after reconnecting the power, please contact IAI.</p>
0F8	Damaged nonvolatile memory	<p>Abnormal data was detected during the nonvolatile memory check after starting.</p> <p>Cause: [1] Faulty nonvolatile memory [2] The memory has been rewritten more than 100,000 times. (The nominal rewrite limit of the nonvolatile memory is around 100,000 times.)</p> <p>Action: If the alarm is generated again after reconnecting the power, please contact IAI.</p>
0FA	CPU error	<p>The CPU was not operating properly.</p> <p>Cause: [1] Faulty CPU [2] Malfunction due to noise</p> <p>Action: If the alarm is generated again after reconnecting the power, please contact IAI.</p>

6.4 Messages Displayed during Operation Using the Teaching Pendant or PC Software

This section explains the warning messages that may be displayed during operation using the teaching pendant or PC software.

Code	Message name	Cause/Action
112	Invalid data	An inappropriate value was entered in a parameter. (Example) 9601 was entered as the serial communication speed by mistake. Reenter an appropriate value.
113 114	Value too small Value too large	The entered value is smaller than the setting range. The entered value is larger than the setting range. Refer to the actuator specifications or parameter table and reenter an appropriate value.
115	Home return non-completion	The current position was written when home return was not yet completed. Execute home return again.
117	No movement data	Target position is not set under the selected position number. Enter the target position first.
11E	Paired data mismatch	The values indicating the magnitude relationship of a pair of data are inappropriate. (Example) The same value was entered in both the parameters for + and – soft limits. Reenter appropriate values.
11F	Absolute position too small	The minimum movement toward the target position is determined by the lead length of the drive system and resolution of the encoder. This message indicates that the entered target value is smaller than the minimum movement. (Example) If the lead length is 20mm, the encoder's resolution is 800 pulses and accordingly the minimum movement becomes $20 \div 800 = 0.025$ mm/pulse. In this case, this message will be displayed if 0.02mm is entered as the target position.
121	Push & hold search end over	The final position in push & hold operation exceeds the soft limit. This has no negative effect if the actuator contacts the work. If the actuator misses the work, however, the soft limit will be reached and this message is displayed as a warning. Change either the target position or positioning band.
122	Multiple axes connected at assignment	Address was assigned when multiple axes were connected. Assign each address only when one axis is connected.
180 181 182 183	Address change OK Controller initialization OK Home change all clear I/O function changed	These messages are displayed to confirm operation. (They do not indicate an operation error or other abnormality.)
202	Emergency stop	An emergency stop condition was detected. (This is not an error.)
20A	Servo OFF during operation	This message indicates that the servo ON signal (SON) was turned OFF by the PLC while the actuator was moving, and that the servo turned OFF and the movement was disabled as a result.

Code	Message name	Cause/Action
20C	CSTR-ON during operation	This message indicates that the start signal (CSTR) became "1" by the PLC while the actuator was moving, and that duplicate movement commands occurred as a result.
20E	Soft limit over	This message indicates that a soft limit was reached.
210	HOME-ON during operation	This message indicates that the home return signal (HOME) became "1" by the PLC while the actuator was moving, and that duplicate movement commands occurred as a result.
221	Write in monitor mode prohibited	This message indicates that position table or parameter writing operation was performed in the monitor mode.
223	Operation in monitor mode prohibited	This message indicates that actuator movement operation was performed in the monitor mode.
301 302 304 305 306 308 30A 30B	Overrun error (M) Framing error (M) SCIR-QUE OV (M) SCIS-QUE OV (M) R-BF OV Response timeout (M) Packet R-QUE OV Packet S-QUE OV	<p>These messages indicate an error in the serial communication with the controller.</p> <p>Cause: [1] Garbage data due to the effect of noise [2] Duplicate slave numbers when multiple controllers are controlled by serial communication.</p> <p>Action: [1] Adjust the wiring in a manner eliminating the effect of noise and review the installation of equipment, etc. [2] Change the slave numbers to avoid duplication.</p> <p>If the message is still displayed after taking the above actions, please contact IAI.</p>
307 309	Memory command refused Write address error	<p>This message indicates that the command was refused in the serial communication with the controller.</p> <p>This message indicates that an indeterminate WRITE address error occurred in the serial communication with the controller.</p> <p>These conditions do not occur in normal operation. Should they occur, record the entire error list before cutting off the power for use in the cause investigation.</p> <p>Also contact IAI.</p>
30C	No connected axis	<p>This message indicates that no controller axis number is recognized.</p> <p>Cause: [1] The controller is not operating properly. [2] Only the supplied communication cable (SGA/SGB) is disconnected. [3] If a SIO converter is used, 24V is supplied to the converter but the link cable is not connected. [4] The ASDRS switch settings are duplicated by mistake when multiple connectors are linked.</p> <p>Action: [1] Check if the RDY lamp on the controller is lit. If the lamp is not lit, the controller is faulty. [2] If a spare teaching pendant is available, replace the current pendant with the spare unit, or with a PC, and see if the message disappears. [3] Supply power after connecting the link cable between the converter and controller. [4] Make sure the ADRS switch settings are not duplicated.</p> <p>If the message is still displayed after taking the above actions, please contact IAI.</p>

6.5 Specific Problems

- The ALM lamp illuminates in red when the power is input.

(An alarm is present, or an emergency stop has been actuated or the motor power is cut off.)

Check whether an alarm is present by connecting the PC or teaching pendant. If an alarm is present, check the description of the error and remove the cause.

If an error is not present, the emergency stop circuit may be activated.

Check the following items:

- [1] Was the emergency-stop switch on the operational panel pressed? Also confirm that the necessary interlocks are released.
- [2] Was the emergency-stop switch on the teaching pendant pressed?
- [3] Was parameter No. 42 [enable function] set as Enable by mistake by connecting the teaching pendant incompatible with the enable switch?
- [4] If multiple controllers are connected, are the crossover wires connected correctly?

- The SV lamp does not illuminate when the servo ON signal is input after the power was input.

(The servo does not turn ON.)

Cause: Since a controller failure is suspected, please contact IAI.

- Home return ends in mid-process in a vertical application.

Cause: [1] The loading mass exceeds the rating.

[2] The ball screw is receiving torsional stress due to the affixing method of the actuator, tightening of bolts only on one side, etc.

[3] The slide resistance of the actuator itself is large.

Action: [1] If [1] is suspected, increase the value set in parameter No. 13 (Current-limiting value during home return). Increasing this value will cause the home return torque to increase, so do not increase the parameter setting above 75%.

[2] Loosen the fixing bolts and check that the slider moves smoothly.

If the slider moves smoothly, review the affixing method and bolt tightening condition.

[3] If the slide resistance of the actuator itself is large, please contact IAI.

- Noise occurs during downward movements in a vertical application.

Cause: The loading mass exceeds the rating.

Action: [1] Decrease the speed.

[2] Decrease the value set in parameter No. 7 (servo gain number).

Do not decrease the parameter setting below "3."

- Vibration occurs when the actuator is stopped.

Cause: The slider is receiving an external force.

Action: If the external force cannot be removed, increase the value set in parameter No. 12 (Current-limiting value at standstill during positioning).

Increasing this value will cause the holding torque at standstill to increase, so do not increase the parameter setting above 70%.

- The actuator overshoots when decelerated to a stop.

Cause: The load inertia is high due to an inappropriate balance between load and deceleration.

Action: Decrease the acceleration/deceleration setting.

- The home and target positions sometimes shift.

Cause: [1] The encoder waveform is disturbed by the effect of noise.

[2] In the case of a rod-type actuator, the non-rotation accuracy increased due to application of rotating moment to the rod.

Action: [1] Check if the grounding is implemented correctly. Also check for any equipment being a potential noise source.

[2] The actuator may have to be replaced in some cases. Please contact IAI.

- The speed is slow during push & hold operation.

Cause: The set current-limiting value is low with respect to the load and slide resistance.

Action: Increase the current-limiting value for push & hold operation.

- The actuator moves only half of the specified distance or twice.

Cause: [1] The combination of the controller and actuator is incorrect.

Since the lead length of the ball screw varies depending on the actuator type, incorrect combination changes the moving distance and speed.

[2] IAI's error before shipment.

Action: [1] If there are multiple actuators of different types, check them for adequacy before connecting them with the controller by the attached seal labels etc.

[2] Please contact IAI.

● A servo error occurred while the actuator was moving (Robo Gripper).

Cause: The work was not positioned properly and contacted the finger attachment in the positioning mode.

Action: Adjust the starting position of push action and the thickness of finger attachment (including buffer material) by considering a possible offset of work position, so that the work can be clamped properly in the push & hold mode.

Immediately after recovery from the error, the feed mechanism may still be locked. Be sure to turn the open/close screw to loosen each finger attachment before resetting the alarm.

Caution: If the servo ON signal is displayed or the alarm is reset while the servo ON signal is still ON, the servo will remain ON.
If the open/close screw is turned in this condition, the screw will return automatically and the lock cannot be released. Therefore, reissuing a movement command will cause the alarm to generate again.

[Two-finger type]

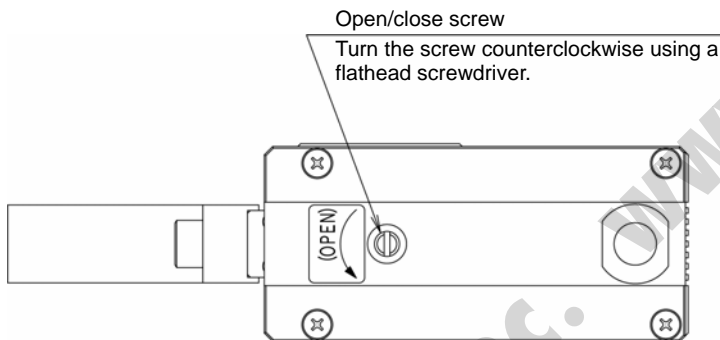

[Three-finger type]

After removing the work by removing the finger attachment first, turn the open/close screw clockwise.

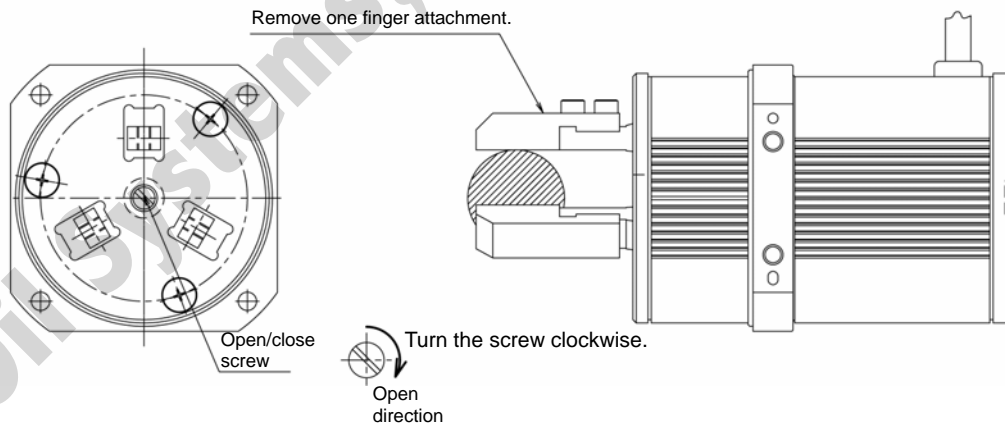

- A malfunction occurs when the servo turns ON after the power is input.

Cause: Exciting-phase detection is not normally performed when the servo turns ON due to the following:

- [1] The slider or rod is contacting the mechanical end.
- [2] Transferred work is pushed by a strong external force.

Action: [1] Check that the slider or rod is not contacting the mechanical end.

If it is contacting the mechanical end, separate it.

If the actuator is equipped with a brake, move it after forcibly releasing the brake by turning on the brake release switch. At this time, exercise caution not to allow work to drop suddenly due to its own weight.

Your hand may be caught by the dropped work or the robot hand or work itself may be damaged.

If the actuator cannot be moved by hand, there is also a method of changing the detection direction as necessary. Consult with IAI in advance.

For details, refer to "5.2.2 Parameters Relating to Actuator Operating Characteristics."

- [2] Check that the transferred work is not interfering with peripheral equipment.

If it is interfering, separate it 1mm or more as a guide.

Taking action in [1] and [2] does not solve the problem, please contact IAI.

- The SV lamp flashes in green.

It indicates that the automatic servo is OFF. (Not an error or failure)

7. Operation Examples

For operation examples of this product, refer to the following operation manuals:

- Device Net Gateway Unit Operation Manual
- CC-Link Gateway Unit Operation Manual
- Communication Related Operation Manual on Models Specifically for Serial Communication

Air-Oil Systems, Inc. www.airoil.com

* Appendix

List of Actuator Specifications

● Slider ball screw driven type

	Type	Stroke (mm) and maximum speed (mm/sec) *Note 1																Load capacity *Note 2		Rated acceleration	
																		Horizontal	Vertical	Horizontal	Vertical
		50	100	150	200	250	300	350	400	450	500	550	600	700	800	900	1000	(kg)	(kg)	(G)	(G)
Motor straight	RCP2-SA5C-□-PM-12-□□□	600																4	1	0.3	0.2
	RCP2-SA5C-□-PM-6-□□□	300																8	2.5	0.3	0.2
	RCP2-SA5C-□-PM-3-□□□	150																8	4.5	0.2	0.2
	RCP2-SA6C-□-PM-12-□□□	600																6	1.5~1	0.3	0.2
	RCP2-SA6C-□-PM-6-□□□	300																12	3~2.5	0.3	0.2
	RCP2-SA6C-□-PM-3-□□□	150																12	6~4	0.2	0.2
	RCP2-SA7C-□-PM-16-□□□	533																35~7	5~0.5	0.3	0.2
	RCP2-SA7C-□-PM-8-□□□	266																40~10	10~1.5	0.3	0.2
	RCP2-SA7C-□-PM-4-□□□	133																40	15~5	0.2	0.2
	RCP2-SS7C-□-PM-12-□□□	600																30~6	4~1	0.3	0.2
	RCP2-SS7C-□-PM-6-□□□	300																30~20	8~2	0.3	0.2
	RCP2-SS7C-□-PM-3-□□□	150																30~20	12~4	0.2	0.2
	RCP2-SS8C-□-PM-20-□□□	666 (600)																40~10	5~0.5	0.3	0.2
	RCP2-SS8C-□-PM-10-□□□	333 (300)																50~4	12~2	0.3	0.2
RCP2-SS8C-□-PM-5-□□□	165 (150)																55~10	20~0.5	0.2	0.2	
Motor folding	RCP2-SA5R-□-PM-12-□□□	600																4	1	0.3	0.2
	RCP2-SA5R-□-PM-6-□□□	300																8	2.5	0.3	0.2
	RCP2-SA5R-□-PM-3-□□□	150																8	4.5	0.2	0.2
	RCP2-SA6R-□-PM-12-□□□	600																6	1.5~0.5	0.3	0.2
	RCP2-SA6R-□-PM-6-□□□	300																12	3~2	0.3	0.2
	RCP2-SA6R-□-PM-3-□□□	150																12	6~4	0.2	0.2
	RCP2-SA7R-□-PM-16-□□□	533 (400)																25~4	5~1	0.3	0.2
	RCP2-SA7R-□-PM-8-□□□	266																35~7	10~1.5	0.3	0.2
	RCP2-SA7R-□-PM-4-□□□	133																35~20	15~3	0.2	0.2
	RCP2-SS7R-□-PM-12-□□□	600 (440)																20~5.5	4~0.5	0.3	0.2
	RCP2-SS7R-□-PM-6-□□□	250																20~2.5	5~0.5	0.3	0.2
	RCP2-SS7R-□-PM-3-□□□	105																30~20	10~1.5	0.2	0.2
	RCP2-SS8R-□-PM-20-□□□	600 (333)																23~1	3~0.5	0.3	0.2
	RCP2-SS8R-□-PM-10-□□□	300 (250)																28~4	9~0.5	0.3	0.2
RCP2-SS8R-□-PM-5-□□□	160 (140)																55~1.5	20~0.5	0.2	0.2	

*Note 1: The numbers shown in each band indicate the maximum speed per stroke.
 *Note 2: The load capacity is the value when the actuator is operated at the rated speed.

● Slider belt driven type

Type	Stroke (mm) and maximum speed (mm/sec) *Note 1														Load capacity *Note 2		Rated acceleration	
															Horizontal	Vertical	Horizontal	Vertical
	500	550	600	650	700	750	800	850	900	950	1000	1050	1100	1150	1200	(kg)	(kg)	(G)
RCP2-BA6-□-PM-54-□□□	1000														4~2	—	0.5	—
RCP2-BA7-□-PM-54-□□□	1500														8~2	—	0.5	—
RCP2-BA6U-□-PM-54-□□□	1000														4~2	—	0.5	—
RCP2-BA7U-□-PM-54-□□□	1500														8~2	—	0.5	—

● Rod Type

Type	Stroke (mm) and maximum speed (mm/sec) *Note 1																Load capacity *Note 2		Rated acceleration		
																	Horizontal	Vertical	Horizontal	Vertical	
	50	100	150	200	250	300	350	400	450	500	550	600	700	800	900	1000	(kg)	(kg)	(G)	(G)	
Standard	RCP2-RA2C-I-PM-1-□□□	25																7	2.5	0.05	0.05
	RCP2-RA3C-□-PM-5-□□□	187																15~2	6~1	0.2	0.2
	RCP2-RA3C-□-PM-2.5-□□□	114																30~4	10~2	0.2	0.2
	RCP2-RA4C-□-PM-10-□□□	458 458 350																25~5	4.5~0.5	0.2	0.2
	RCP2-RA4C-□-PM-5-□□□	250 237 175																40~10	12~2	0.2	0.2
	RCP2-RA4C-□-PM-2.5-□□□	125(110) 118 87																40	19~2.5	0.2	0.2
	RCP2-RA6C-□-PM-16-□□□	450(400)																40~10	5~1	0.2	0.2
	RCP2-RA6C-□-PM-8-□□□	210																50~30	17.5~1.5	0.2	0.2
	RCP2-RA6C-□-PM-4-□□□	130																55~35	26~1.5	0.2	0.2
Drip proof	RCP2W-RA4C-I-PM-10-□□□	450(250)																25~5	4.5~2	0.2	0.2
	RCP2W-RA4C-I-PM-5-□□□	190																40	12~2.5	0.2	0.2
	RCP2W-RA4C-I-PM-2.5-□□□	120(115)																40	19~2.5	0.2	0.2
	RCP2W-RA6C-I-PM-16-□□□	320(265)																40~20	5~1	0.2	0.2
	RCP2W-RA6C-I-PM-8-□□□	200																50	17.5~2	0.2	0.2
	RCP2W-RA6C-I-PM-4-□□□	100																55	26~5	0.2	0.2
w/Single guide	RCP2-RGS4C-□-PM-10-□□□	458 458 350																2.5~0.5	3.5~0.5	0.2	0.2
	RCP2-RGS4C-□-PM-5-□□□	250 237 175																3.5~1	11~0.5	0.2	0.2
	RCP2-RGS4C-□-PM-2.5-□□□	125(114) 118 87																4~1.5	18~1.5	0.2	0.2
	RCP2-RGS6C-□-PM-16-□□□	450(400)																3~1	4~0.5	0.2	0.2
	RCP2-RGS6C-□-PM-8-□□□	210																4~1.5	16~1	0.2	0.2
	RCP2-RGS6C-□-PM-4-□□□	133																5~2	24~0.5	0.2	0.2
w/Double guide	RCP2-RGD3C-□-PM-5-□□□	187																1.5~0.5	5~0.5	0.2	0.2
	RCP2-RGD3C-□-PM-2.5-□□□	114(93)																2~0.5	9~1	0.2	0.2
	RCP2-RGD4C-□-PM-10-□□□	458 458 350																3.5~1	3.5~0.5	0.2	0.2
	RCP2-RGD4C-□-PM-5-□□□	250 237 175																4.5~2	11~0.5	0.2	0.2
	RCP2-RGD4C-□-PM-2.5-□□□	125(114) 118 87																5~2.5	18~1.5	0.2	0.2
	RCP2-RGD6C-□-PM-16-□□□	450(400)																4~1	4~0.5	0.2	0.2
	RCP2-RGD6C-□-PM-8-□□□	210																5~1.5	16~1	0.2	0.2
	RCP2-RGD6C-□-PM-4-□□□	133																5~2	24~0.5	0.2	0.2

*Note 1: The numbers shown in each band indicate the maximum speed per stroke. The numbers in parentheses indicate the speeds for the vertical application.
 *Note 2: The load capacity is the value when the actuator is operated at the rated speed.

● Gripper type

Type	Stroke	Maximum gripping force	Maximum speed	Lead	Rated acceleration	
Two-finger	RCP2-2GRS-I-PM-1-10-P1	10mm (one side: 5mm)	21N	33.3 mm/s (one side)	1.0mm	0.3G
	RCP2-2GRS-I-PM-1-14-P1	14mm (one side: 7mm)	80N	36.7 mm/s (one side)	1.1mm	0.3G
Three-finger	RCP2-GR3SS-I-PM-30-10-P1	10mm (one side: 5mm)	23N	40 mm/s (one side)	2.5mm	0.2G
	RCP2-GR3SM-I-PM-30-14-P1	14mm (one side: 7mm)	120N	50 mm/s (one side)	3.0mm	0.2G
	RCP2-GR3LS-I-PM-30-19-P1	19°	17N	200°/s (one side)	12°	0.2G
	RCP2-GR3LM-I-PM-30-19-P1	19°	62N	200°/s (one side)	12°	0.2G

● Rotary type

Type	Oscillating angle	Maximum torque	Maximum speed	Reduction ratio	Rated acceleration	
Vertical	RCP2-GTB-I-PM-20-330-P1	330°	1.1 N·m	600°/s	1/20	0.3G
	RCP2-GTB-I-PM-30-330-P1	330°	1.7 N·m	400°/s	1/30	0.3G
Flat	RCP2-GTB-I-PM-20-330-P1	330°	1.1 N·m	600°/s	1/20	0.3G
	RCP2-GTB-I-PM-30-330-P1	330°	1.7 N·m	400°/s	1/30	0.3G

● Correlation Diagrams between Speed and Load Capacity for Slider Type (Motor Straight Type)

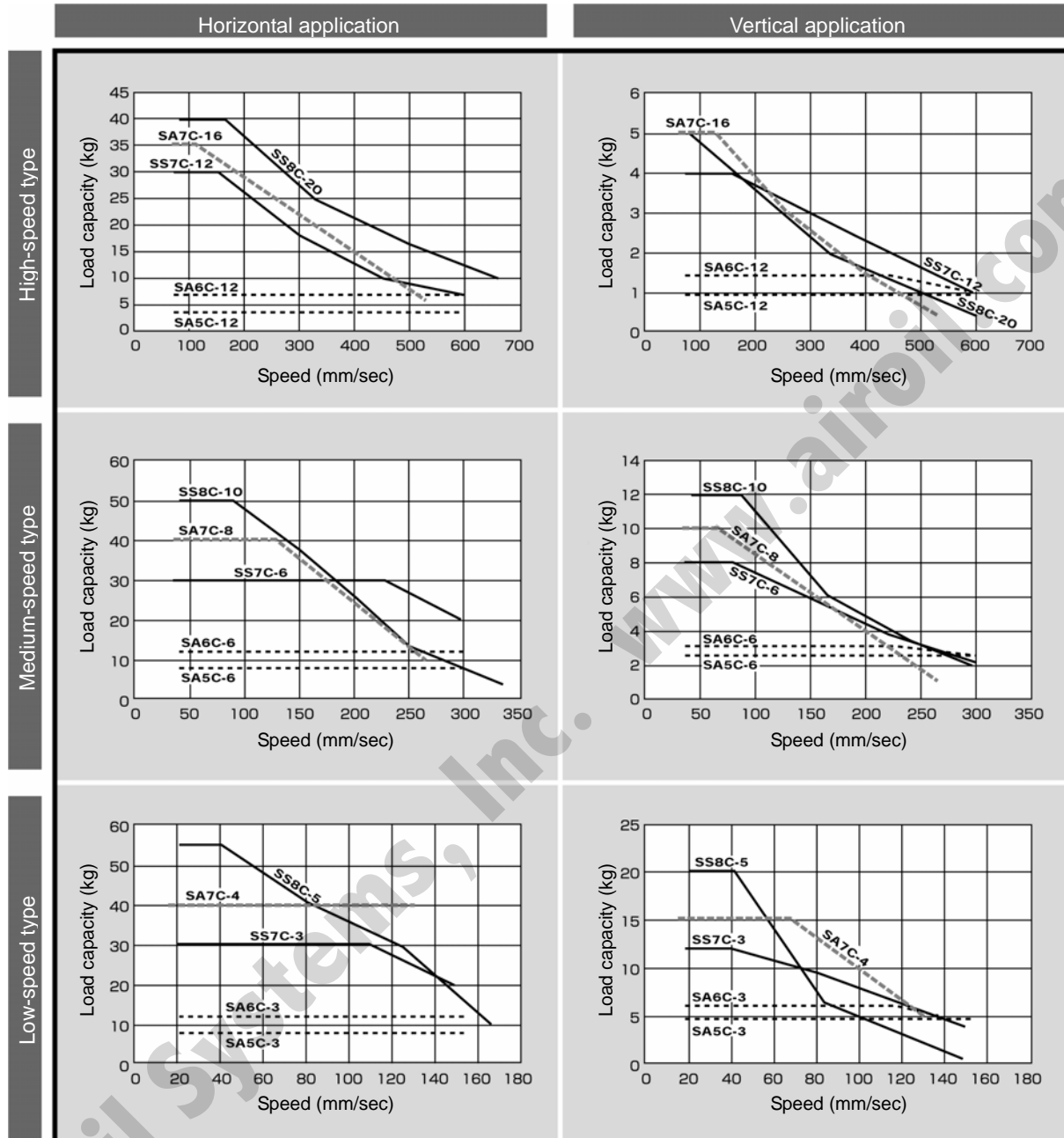

*Note: The numbers shown after the type in the above graphs indicate the lead specification.

● Correlation Diagrams between Speed and Load Capacity for Slider Type (Motor Folding Type)

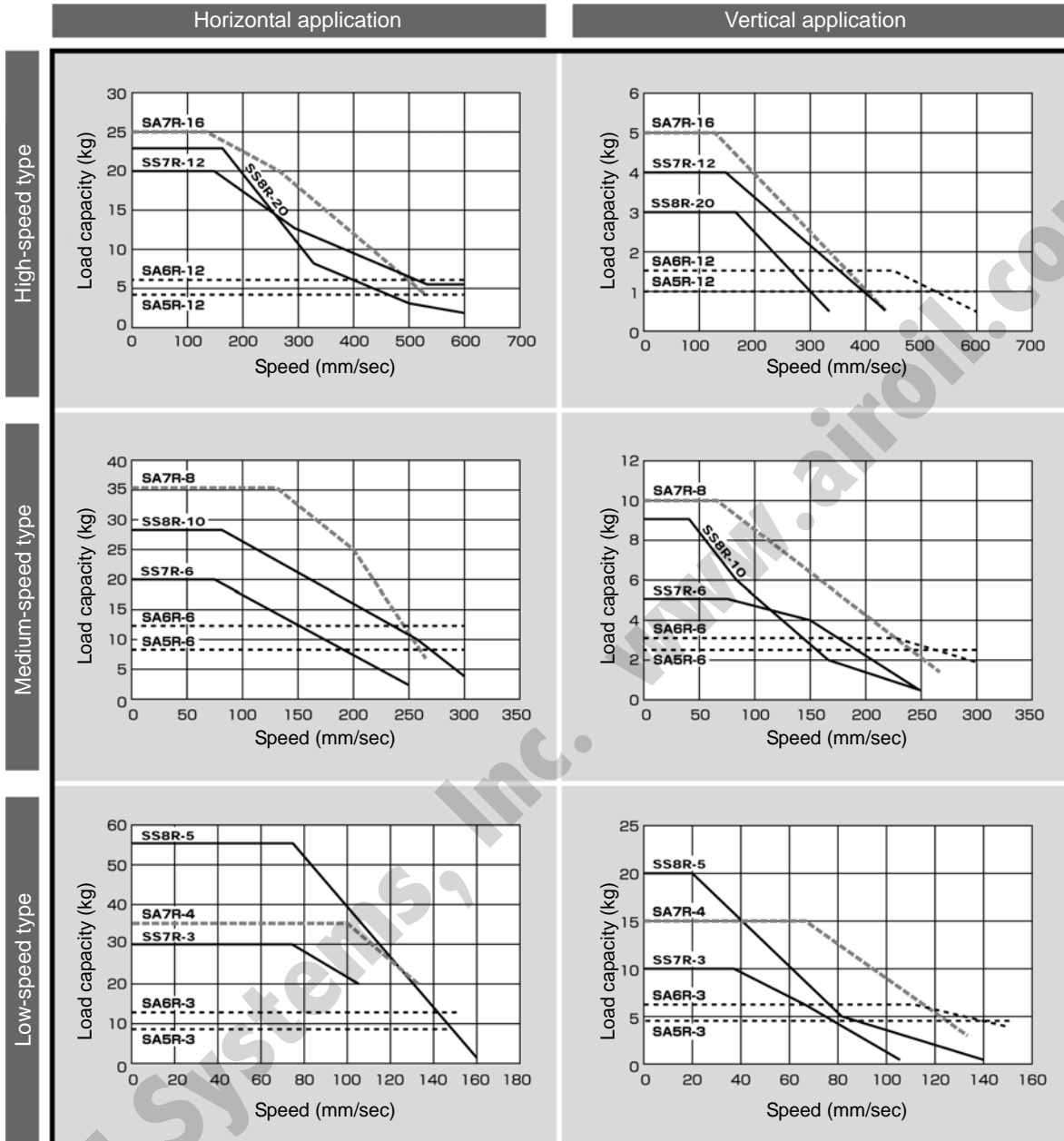

*Note: The numbers shown after the type in the above graphs indicate the lead specification.

● Correlation Diagram between Speed and Load Capacity for Rod Standard Type

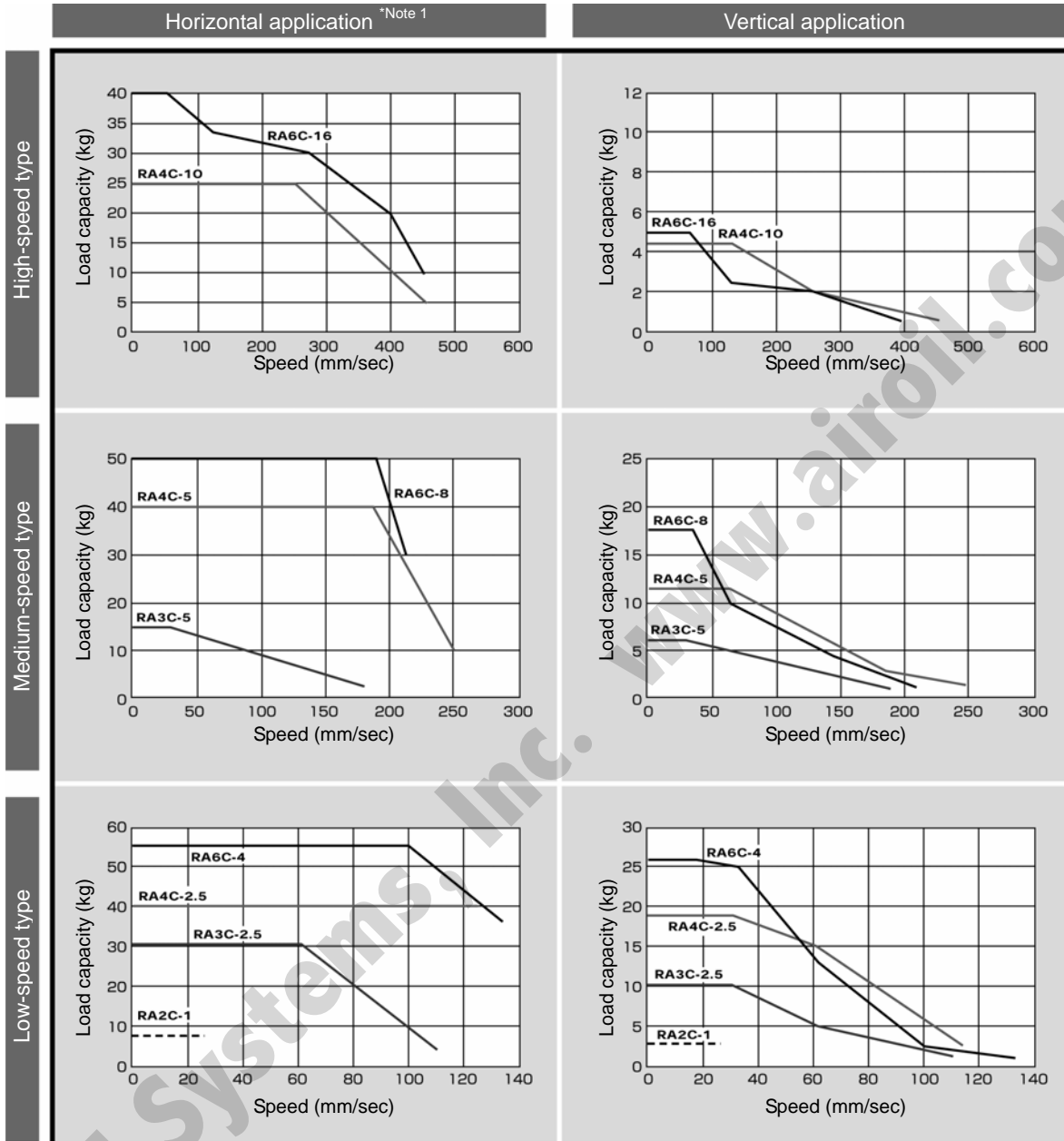

*Note: The numbers shown after the type in the above graphs indicate the lead specification.

*Note 1: The horizontal application assumes the use of an external guide.

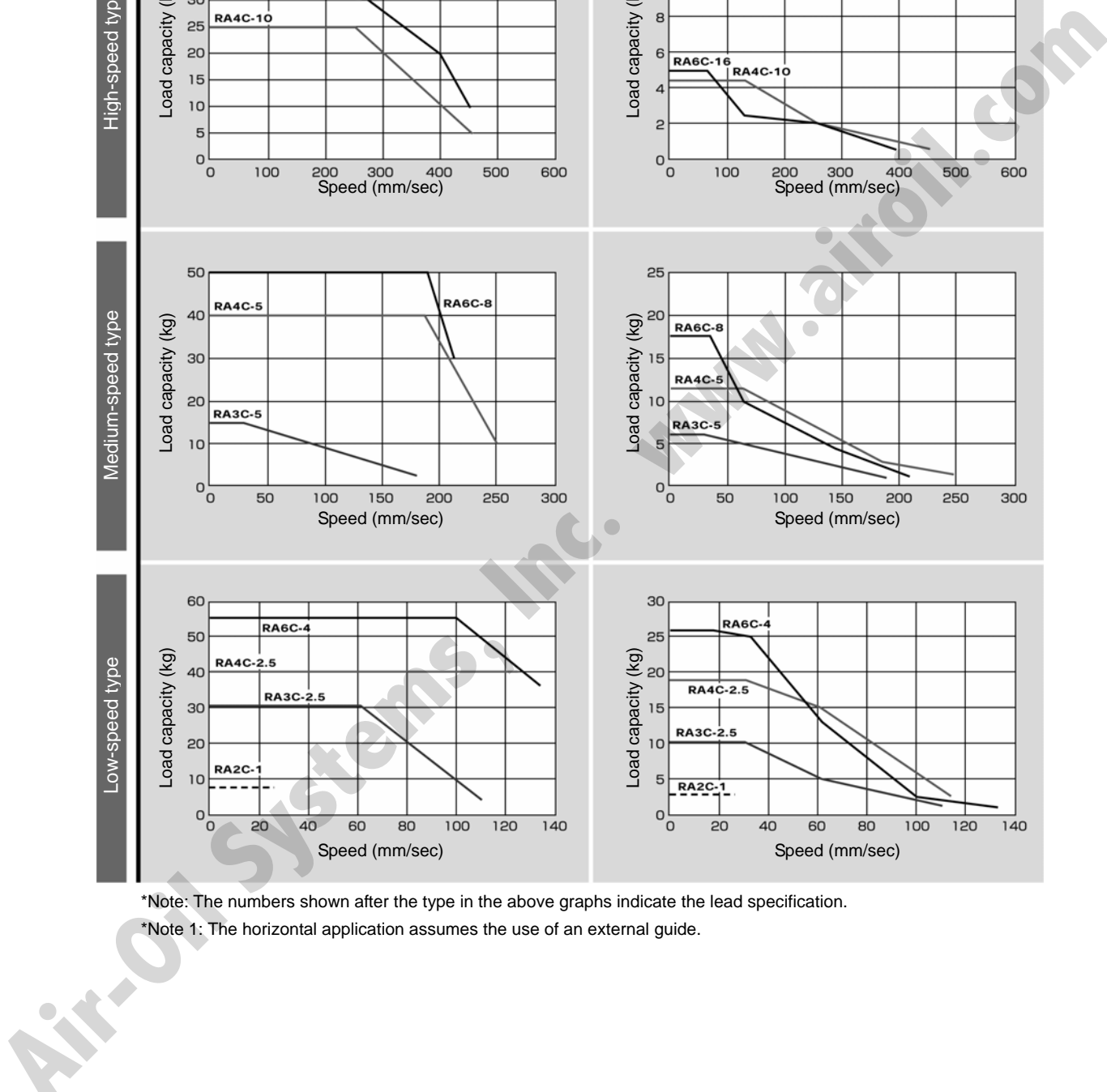

● Correlation Diagrams between Speed and Load Capacity for Type with Single Guide

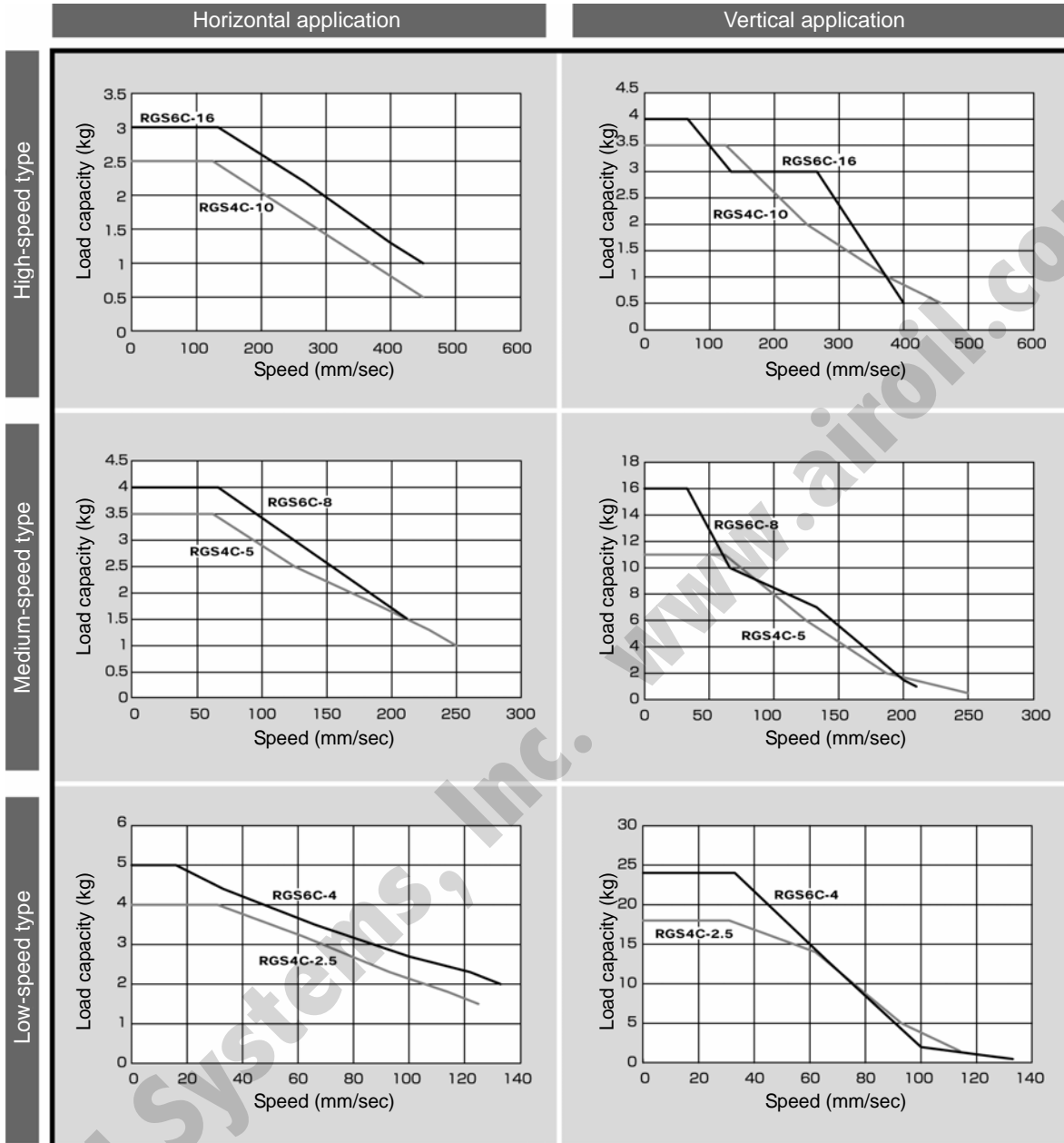

(Note) The numbers shown after the type in the above graphs indicate the lead specification.

● Correlation Diagrams between Speed and Load Capacity for Type with Double Guide

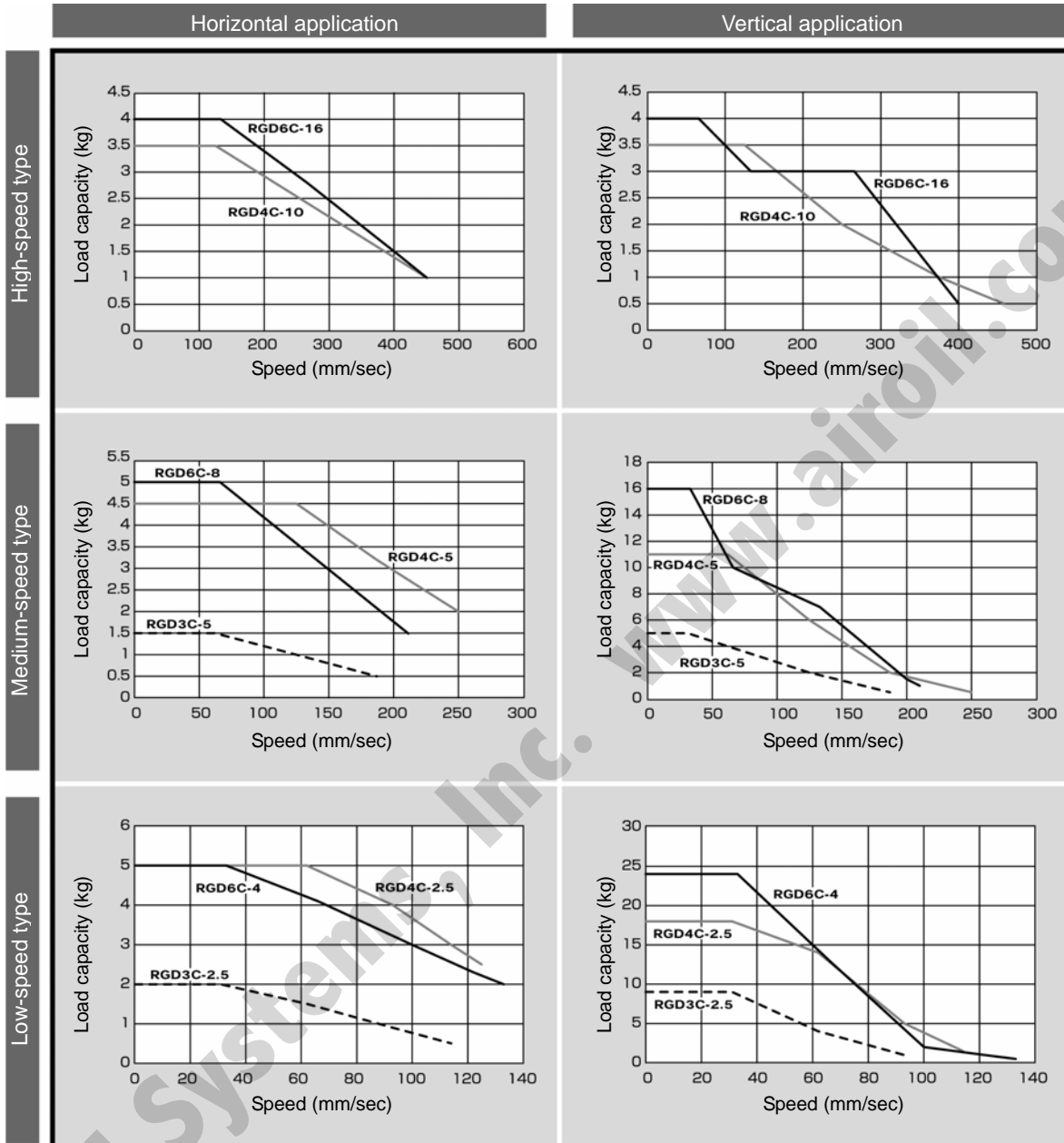

(Note) The numbers shown after the type in the above graphs indicate the lead specification.

● Correlation Diagrams between Speed and Load Capacity for Dust and Drip Proof Type

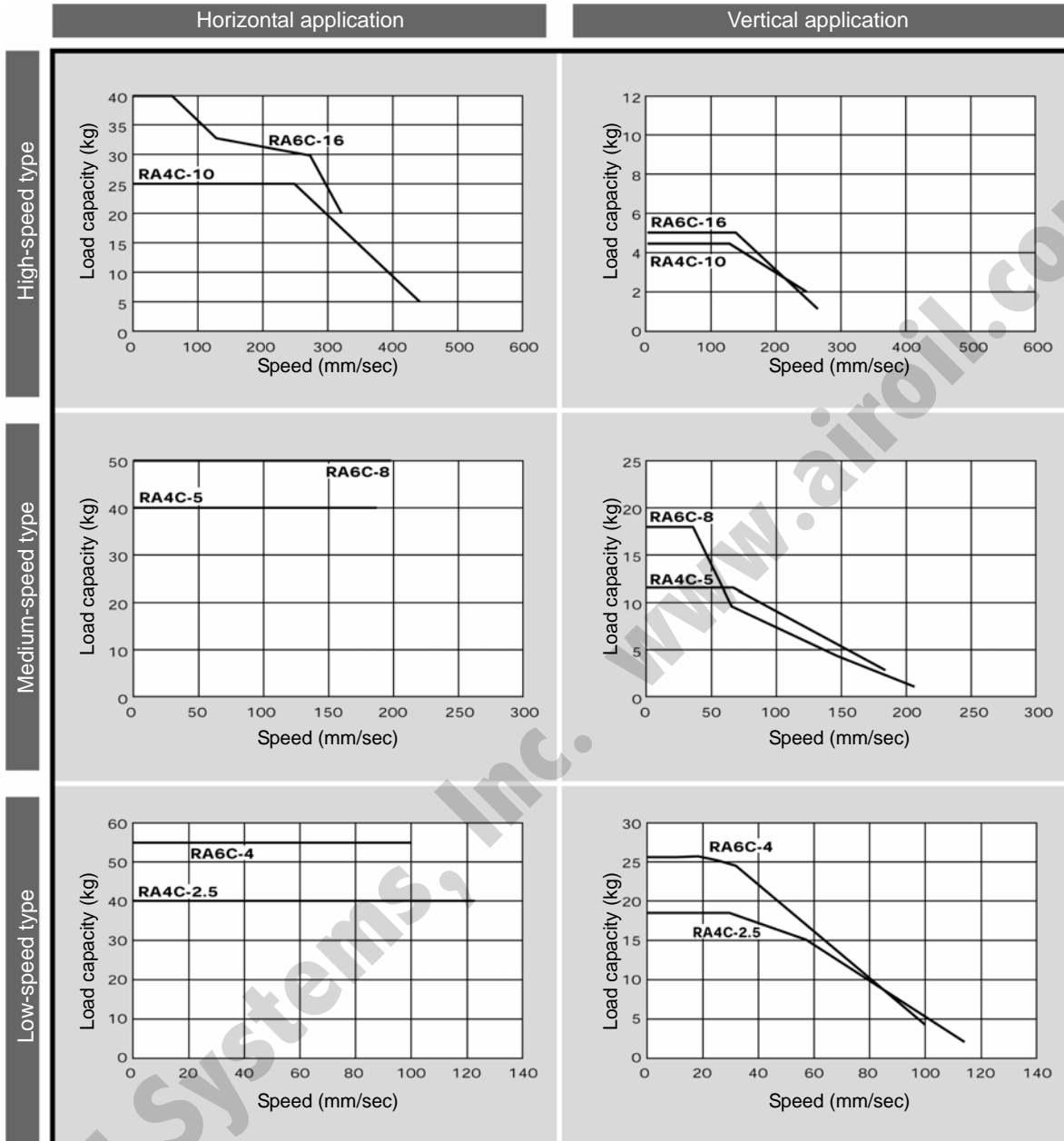

*Note: The numbers shown after the type in the above graphs indicate the lead specification.

*Note 1: The horizontal application assumes the use of an external guide.

*Note 2: If operated under maximum load capacity, overshoot (vibration) may occur. Therefore, please provide an allowance of approximately 70%.

Recording of Position-Data Table

Recorded date: _____

No.	Position [mm]	Speed [mm/s]	Acceleration [G]	Deceleration [G]	Push [%]	Threshold [%]	Positioning band [mm]	Zone + [mm]	Zone - [mm]	Acceleration mode	Incremental	Command mode	Stop mode
0													
1													
2													
3													
4													
5													
6													
7													
8													
9													
10													
11													
12													
13													
14													
15													
16													
17													
18													

No.	Position [mm]	Speed [mm/s]	Acceleration [G]	Deceleration [G]	Push [%]	Threshold [%]	Positioning band [mm]	Zone + [mm]	Zone - [mm]	Acceleration mode	Incremental	Command mode	Stop mode
0													
1													
2													
3													
4													
5													
6													
7													
8													
9													
10													
11													
12													
13													
14													
15													
16													
17													
18													

Air-Oil Systems, Inc. www.airoil.com

PCCON

No.	Position [mm]	Speed [mm/s]	Acceleration [G]	Deceleration [G]	Push [%]	Threshold [%]	Positioning band [mm]	Zone + [mm]	Zone - [mm]	Acceleration mode	Incremental	Command mode	Stop mode
0													
1													
2													
3													
4													
5													
6													
7													
8													
9													
10													
11													
12													
13													
14													
15													
16													
17													
18													

Recording of Parameters

Recorded date: _____

- a: Parameter relating to the actuator stroke range
- b: Parameter relating to the actuator operating characteristics
- c: Parameter relating to the external interface
- d: Servo gain adjustment

No.	Category	Symbol	Name	Unit	Default factory setting
1	a	ZONM	Zone boundary 1+	mm	
2	a	ZONL	Zone boundary 1-	mm	
3	a	LIMM	Soft limit+	mm	
4	a	LIML	Soft limit-	mm	
5	a	ORG	Home return direction (0: Reverse/1: Forward)	—	
6	b	PSWT	Push & hold stop judgment period	msec	
7	d	PLG0	Servo gain number	—	
8	b	VCMD	Default speed	mm/sec	
9	b	ACMD	Default acceleration/deceleration	G	
10	b	INP	Default positioning band (in-position)	mm	
12	b	SPOW		%	
13	b	ODPW	Current-limiting value during home return	%	
16	c	BRSL	Serial communication speed	bps	
17	c	RTIM	Minimum delay time for slave transmitter activation	msec	
22	a	OFST	Home return offset	mm	
23	a	ZNM2	Zone boundary 2+	mm	
24	a	ZNL2	Zone boundary 2-	mm	
28	b	PHSP1	Default movement direction for excitation-phase signal detection (0: Reverse/1: Forward)		
29	b	PHSP2	Excitation-phase signal detection time	msec	
31	d	VLPG	Speed loop proportional gain	—	
32	d	VLPT	Speed loop integral gain	—	
33	d	TRQF	Torque filter time constant	—	
34	b	PSHV	Push speed	mm/sec	
35	b	SAFV	Safety speed	mm/sec	
39	c	FPIO1	Position complete signal output method (0: PEND: 1: INP)	—	
42	b	FPIO4	Enable function (0: Valid/1: Invalid)	—	
43	b	AIOF	Home position check sensor input polarity	—	
45	c	SIVM	Silent interval magnification	times	
46	b	OVRD	Speed override	%	
53	b	CTLF	Default stop mode	—	

Air-Oil Systems, Inc. www.airoil.com

Air-Oil Systems, Inc. www.airoil.com

Air-Oil Systems, Inc. www.airoil.com

Air-Oil Systems, Inc. www.airoil.com



IAI America Inc.

Head Office: 2690W 237th Street Torrance, CA 90505
TEL (310) 891-6015 FAX (310) 891-0815
Chicago Office: 1261 Hamilton Parkway Itasca, IL 60143
TEL (630) 467-9900 FAX (630) 467-9912
New Jersey Office: 7 South Main St., Suite-F, Marlboro, NJ 07746
TEL (732) 683-9101 FAX (732) 683-9103

Home page: www.intelligentactuator.com

IAI Industrieroboter GmbH

Ober der Röth 4, D-65824 Schwalbach am Taunus, Germany
TEL 06196-88950 FAX 06196-889524