

CATALOG

# Proportional Technology

*Precise Control of Pressure and Flow*

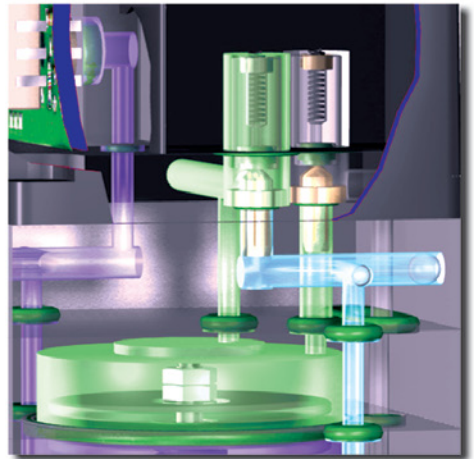
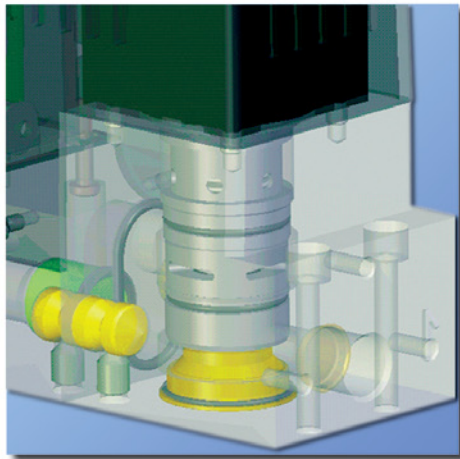
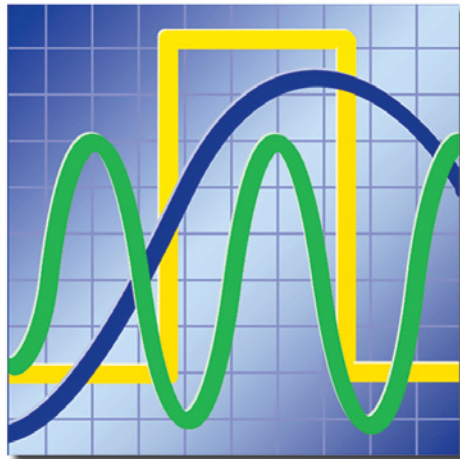

# numatics®

# NUMATICS®

Numatics, Inc. is a leading manufacturer of pneumatic products and motion control products. Our broad spectrum of standard, custom developed products and application components, have made a significant impact on pneumatic innovation as well as pneumatic and motion control technology. Our company has an extensive history of generating innovative concepts and technological breakthroughs. Many of today's standard features in pneumatic technology were industry firsts from Numatics. We continue our innovative approach to product development by developing electric motion control solutions and enhancing our embedded Fieldbus and I/O products to continually meet and solve our customer's application requirements.



Today Numatics is proud to be a part of the Industrial Automation Division of Emerson Electric Co. Emerson (NYSE:EMR), based in St. Louis, Missouri (USA), is a global leader in bringing technology and engineering together to provide innovative solutions for customers in industrial, commercial, and consumer markets through its network power, process management, industrial automation, climate technologies, and appliance and tools businesses. For more information, visit [www.Emerson.com](http://www.Emerson.com).



**EMERSON™**  
Industrial Automation

## **Introduction to Control Technology**

Glossary of Terms .....	2-3
Control Systems / Control Methods .....	4
Types of Controllers .....	5

## **Applications for Proportional Valves**

For Economical Quality and Control .....	6
Application Examples .....	7-9

## **Selection of Proportional Valves**

Technical Characteristics .....	10
Choice of Equipment .....	11

## **Pressure Control**

SENTRONIC <sup>D</sup> / Technical Characteristics .....	12-18
SENTRONIC <sup>PLUS</sup> / Technical Characteristics .....	19-23
E Series / Technical Characteristics .....	24-29



## **Flow Control**

FLOWTRONIC <sup>D</sup> / Technical Characteristics .....	30-34
---	-------



## **Accessories**

CONTROL <sup>D</sup> / Technical Characteristics .....	35-38
--	-------



## **G3 Fieldbus High Current Analog Module**

.....	39
-------	----



### Symbols and Terminology

#### Glossary of Terms

##### Hysteresis

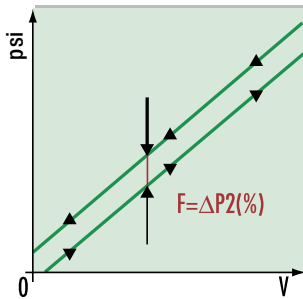

Hysteresis is the tolerance of the outlet pressure for a given command signal depending on whether the previous pressure was higher or lower.

##### Sensitivity

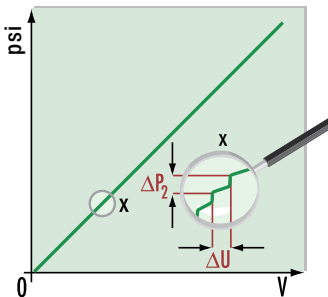

The smallest change in command signal which leads to a change in the outlet pressure is called sensitivity. Expressed as a percentage of the maximum outlet pressure.

##### Linearity

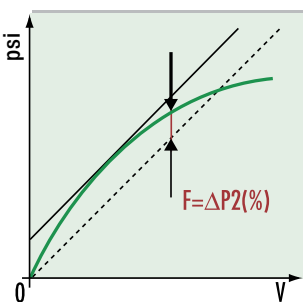

The ideal relationship between command signal and outlet pressure is linear, and when plotted results in a straight line (dotted line). Linearity is a measure of the maximum deviation between the actual outlet pressure and commanded pressure.

##### Repeatability

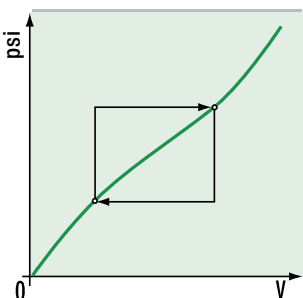

Repeatability is the tolerance of the outlet pressure for the same command signal given multiple times.

#### Symbols

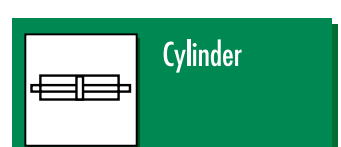
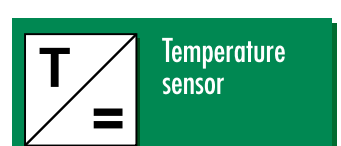
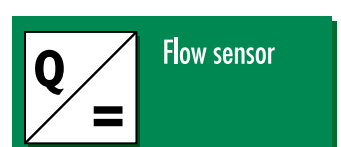
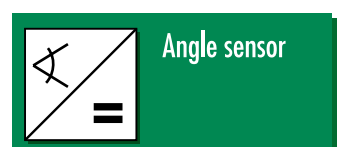

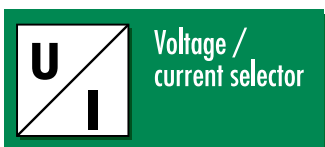
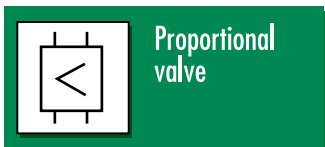
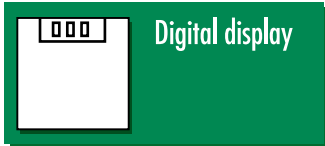
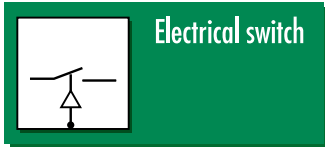

### Zero Adjustment

The pressure or flow that corresponds with the lowest command signal.

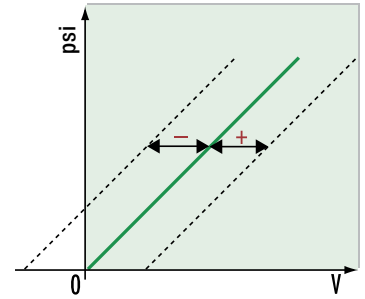

### Span Adjustment

The valve's output pressure or flow range can be reduced to match the application's needs, providing the highest possible resolution.

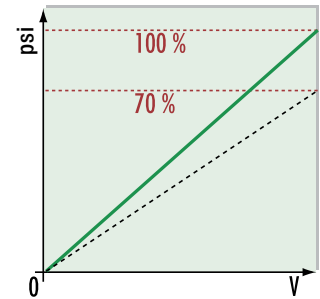

### Ramp Function

The ramp function transforms a command signal step into an internal gradual increase. This allows slow opening and closing of proportional valves.

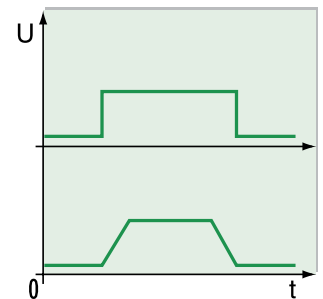

### Ripple Frequency

Modulation voltage to minimize friction (slip-stick) in a valve.

### Feedback Value

Actual electrical value of a physical variable. (Pressure, force, temperature, flow etc.).

### Control Systems

Within industrial automation, the goal of a control system is to move a physical variable such as temperature, pressure, force or displacement to a predetermined value. The complexity of the system, impact of external variables and required accuracy will dictate whether the control system needs some type of feedback measurement in order to ensure that the desired value (or setpoint) is reached. The difference between open-loop and closed-loop control is that the feedback allows the control system, or control loop, to compare the output to the commanded value and adjust as needed.

#### Open-Loop Control

An example of an open control loop is a timer for a sprinkler system. When the timer is activated, the sprinkler goes on for a set amount of time. This is open-loop control because the system does not monitor, for instance, the moisture content of the soil. The system will turn the sprinklers on in the middle of a rainstorm. The desired outcome of the controlled action is not monitored.

An open sequence of actions where there is no comparison of the end result to the desired result is the primary characteristic of open-loop control.

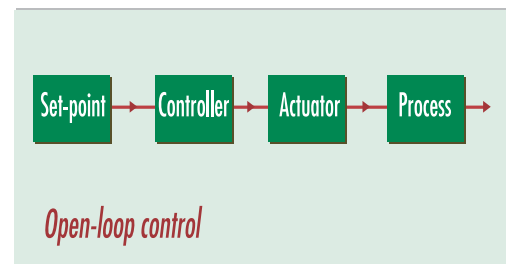

#### Closed-Loop Control

In a closed loop, the desired value or setpoint is constantly compared to the actual value. DIN standard 19226 defines the terms “Control and Adjustment” as follows: “Control and adjustment is an operation in which a physical variable (e.g. temperature, pressure etc.) is continuously measured and compared to a previously specified value of the variable with the aim of matching the two. The resulting closed sequence of actions occurs in a closed loop, the closed-control loop.”

In the example of the sprinkler system, the actual moisture content of the soil could be measured with a sensor and compared to the desired moisture level. As soon as there is a difference between the desired value and measured value, a signal can be sent to either open the water valve (if the soil is dryer than specified) or close the valve (if the soil is wetter than specified). The feedback, provided by the sensor in this case, that is used to compare and adjust the actual value to the desired value is the primary characteristic of a closed-loop system.

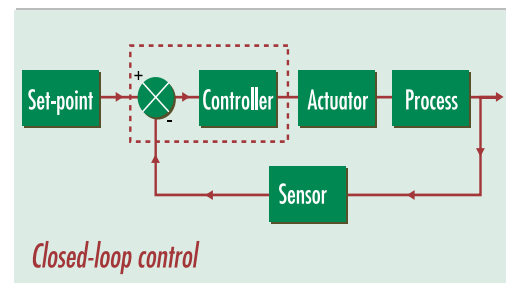

### Types of Controllers

A controller is a transfer element which compares the feedback value received from a transducer (sensor) to a predetermined value (i.e. setpoint) and processes it in such a way that a control signal is transmitted to the actuating element (e.g. a proportional valve). The controller should control this transmission in such a way that the dynamic qualities of the controlled process are balanced. The setpoint should be reached quickly while the feedback value should fluctuate as little as possible around the setpoint.

Numatics' proportional valves use a common controller called a proportional-integral-derivative (PID) controller. The P, I and D terms can easily be modified with each product's software to achieve various types of control based upon the needs of a given application. The most basic controller is the P controller. P, PI and PID control are best suited to a wide range of applications.

The charts to the right show graphical representations of the various PID terms and the table below shows the types of controllers that are most often successful by application.

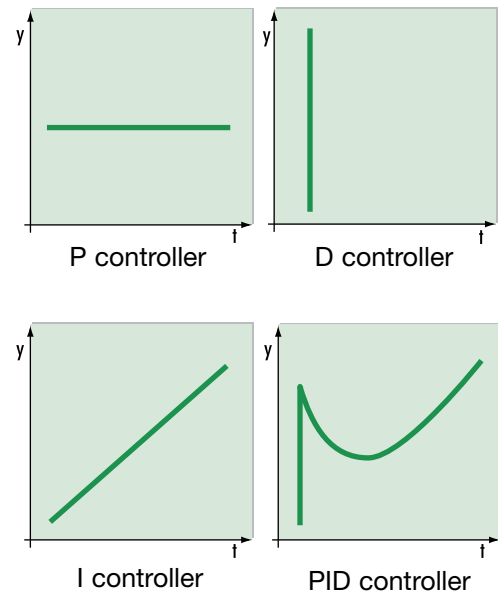

Application	Types of controllers		
	P	PI	PID
Pressure	low profile	suitable	suitable
Flow	unsuitable	suitable	less suitable
Temperature	low profile	suitable	suitable
Level	suitable	unsuitable	unsuitable
Speed	suitable	suitable	suitable

## Proportional Technology Applications for Proportional Valves

### For Economical Quality and Control...

Proportional valves maximize production processes in many industries including food processing, textiles, industrial plant engineering, medical technology, pharmaceutical, semiconductor and automobile. These valves create many innovative solutions when incorporated into a programmable control system. The combination of electronics and mechanics in proportional valves provides ideal performance for many industrial applications. Numatics' proportional pressure regulators and flow control valves are highly customizable to specific applications. Numatics continually develops customized components and solutions for specific customer requirements. Please do not hesitate to contact Numatics' technical support team.

#### Compensation of Lengths in Winding

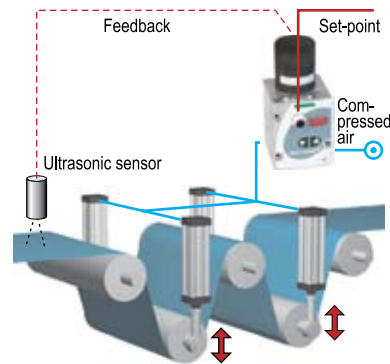

Different lengths of winding material are offset with cylinders controlled by proportional pressure regulators, which controls the tensile stress.

#### Spot Welding

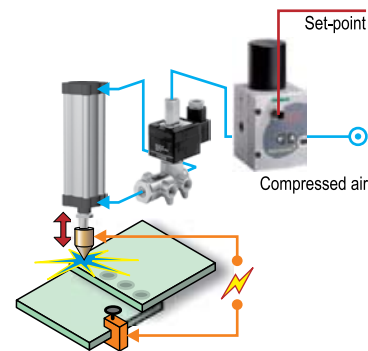

The proportional pressure regulator controls the clamping force of the welding head depending on the material to be welded and its thickness.

#### Compensation of Thickness

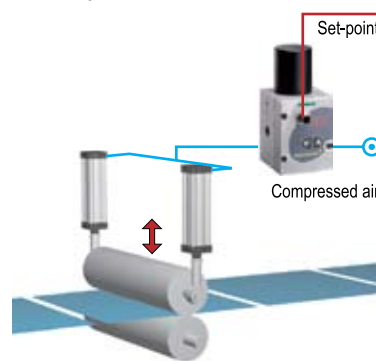

The pressure acting against the roller is controlled with a proportional pressure regulator. Different thickness in the materials is offset.

#### Servo Unit for Brakes

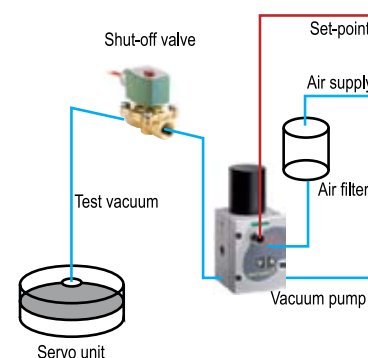

The proportional pressure regulator is incorporated in the bypass of a vacuum pump. The brake booster is checked against the setpoint.



### Control of Pressure and Flow

#### Control of Speed and Torque

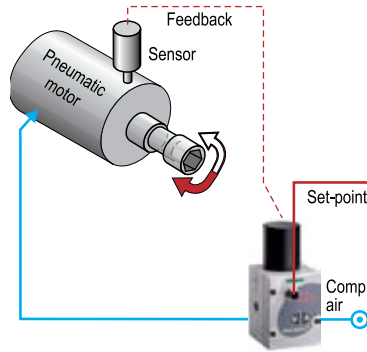

Speed and torque are controlled by changing the pilot pressure.

#### Force

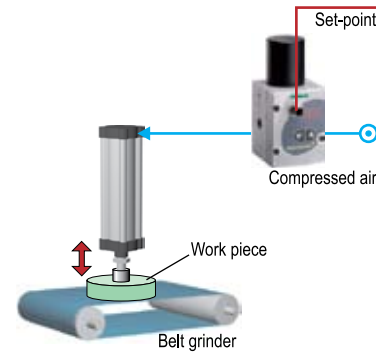

The proportional valve controls the force acting against work pieces on grinding belts, pneumatic presses etc.

#### Paint Spray Gun Application

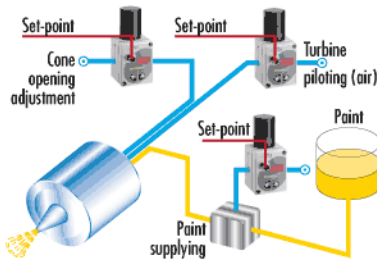

Spray gun control: Control of paint flow and spray density, and of the surface of the part of being painted.

#### Balancer

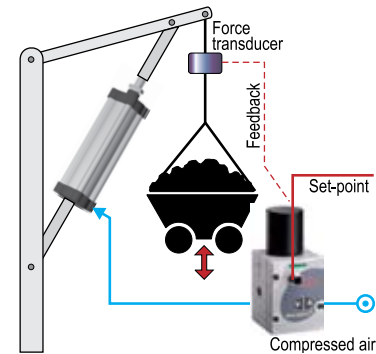

The proportional valve pneumatically balances the weight over the cylinder pressure. Heavy loads can easily be lifted and lowered by hand.

#### Material Testing

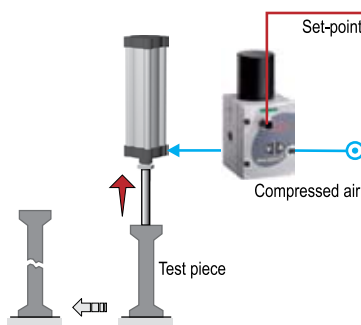

The force acting against the test piece is continuously increased until the test piece is destroyed.

#### Glue Dosing

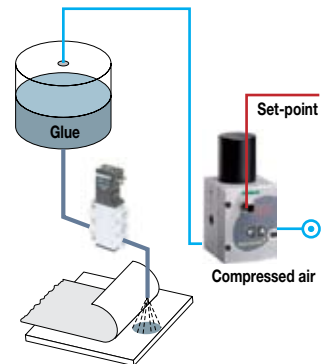

The proportional pressure regulator maintains system pressure as the level of glue in the container decreases. Glue is dosed accordingly.

#### Fluid Coating

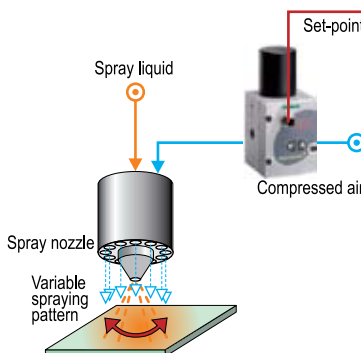

The spray pattern, i.e. the coating width, is adjusted by controlling the air supply through fan adjusting nozzles.

#### Vacuum Generation

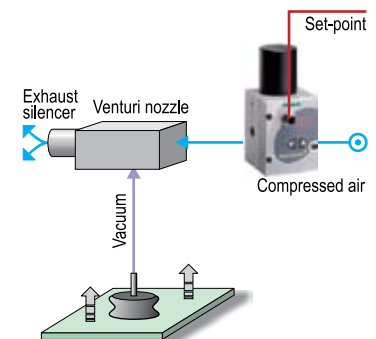

A change of pressure into the venturi nozzle via the proportional valve changes the vacuum generated.

## Proportional Technology Applications for Proportional Valves

### Control of Pressure and Flow

#### Flight Simulator

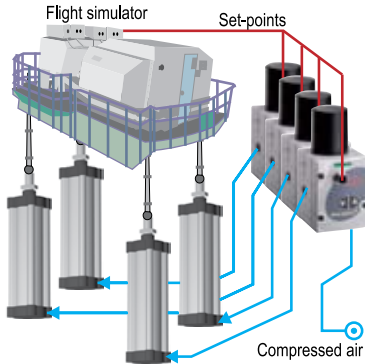

The movements of an aircraft are simulated by applying different pilot pressures to the cylinders.

#### Temperature Control

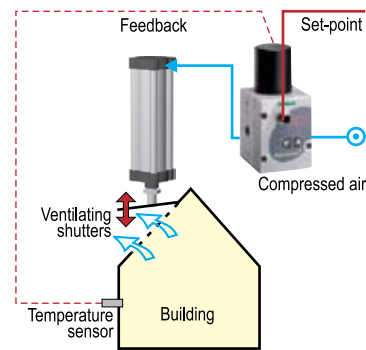

The room temperature is held at a constant level by opening or closing ventilating shutters.

#### Leak Test

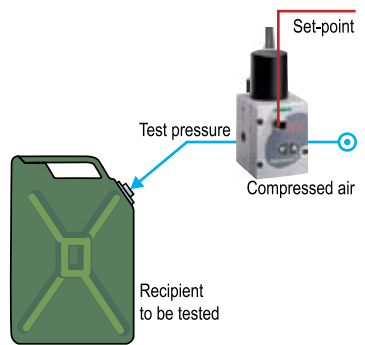

The proportional pressure regulator precisely adjusts the test pressure for different leak tests.

#### Filling Pressure

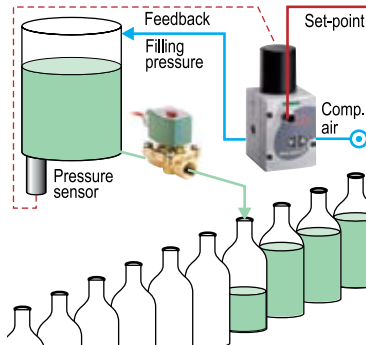

The liquid flows to the valve at a constant pressure irrespective of the fluid level in the storage tank. The filling volume remains constant.

#### Brake Pressure

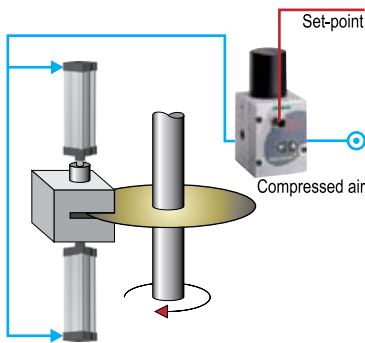

A command signal is used to gradually brake and slow down a rotating mass in accordance with the controller's speed profile.

#### Clamping Pressure Control

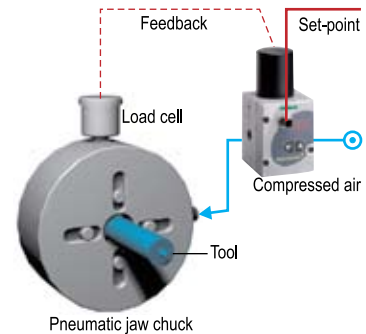

The clamping pressure of machine tools is adjusted in accordance with the tool's material (steel, synthetic material, etc.).

#### Tire Making

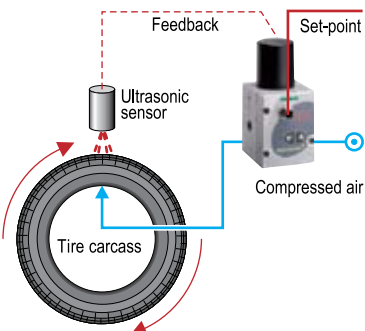

Controlled by the proportional pressure regulator with a dependence on the tire's diameter, the individual plies of the tires are built up and a constant tire quality is ensured.

#### Turbo-Supercharger

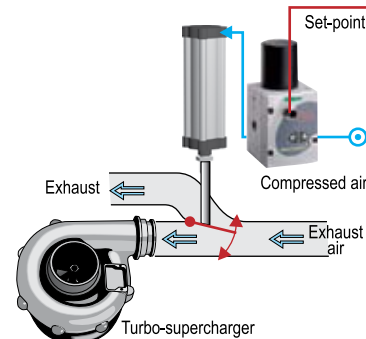

Exhaust gas flow is adjusted to the turbo-supercharger depending on the engine speed to maintain the charging pressure at a constant level.

### Control of Pressure and Flow

Laser Cutting

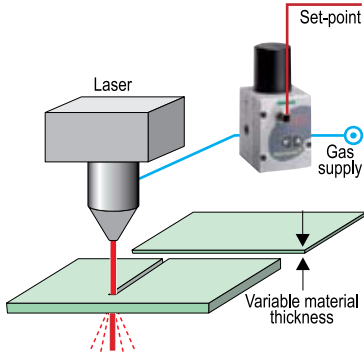

The gas pressure is adjusted in accordance with the material and its thickness.

Ultrasonic Welding

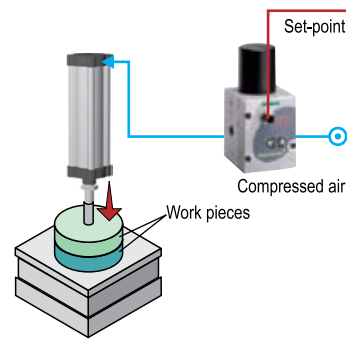

The proportional pressure regulator adjusts the frictional pressure of ultrasonic welding machines.

Bottle Molding

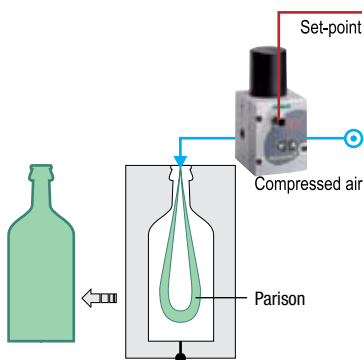

The parison is inflated at a varying rate using a proportional valve.

Flow Control

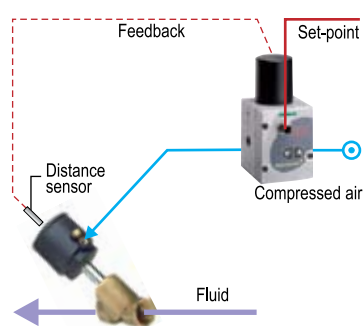

The flow of liquids is varied by continually adjusting the orifice of the fluid valve by measuring the valve's travel (distance sensor).

## Proportional Technology Proportional Valves

### Technical Characteristics



	Port size	Pilot pressure	Pressure range	Flow	Filtration	Hysteresis	Power rating	Type of construction	Loss of power behavior
<b>SENTRONIC<sup>D</sup></b>	1/8, 1/4, 3/8 NPT or GTap	-	0 to 150 psi 0 to 10 bar	up to 45.9 SCFM 1300 NI/min	50 µm	< 1%	21 to 40 W	Poppet valve	Pressure released
<b>SENTRONIC<sup>PLUS</sup></b>	1/8, 1/4, 1/2, 1 NPT or GTap	-	0 to 725 psi 0 to 50 bar	up to 197.8 SCFM 5600 NI/min	50 µm	< 1%	33 to 44 W	Poppet valve	Pressure released
<b>E SERIES</b>	1/8 - 3/4, NPT, GTap or BSPT	-	0 to 150 psi 0 to 10.2 bar	up to 250 SCFM 7000 NI/min	5 µm	< 1%	1 W	Pilot + booster	Pressure held
<b>FLOWTRONIC<sup>D</sup></b>	1/4, 3/8 NPT or GTap	-	0 to 116 psi 0 to 8 bar	0.4 to 35.3 SCFM 10 to 1000 NI/min	50 µm	< 3%	33 to 44 W	Poppet valve	Pressure released

### Choice of Equipment



		Control		Fluids			Control loop		Actuation		Application		Special features	
		Pressure	Flow	Vacuum	Air/neutral gases	Liquids	Steam	open	closed	electrical	air piloted	static		dynamic
	SENTRONIC <sup>D</sup>	●	○		●				●	●		■	▲	Digital control with or without display, controller adaptation
	SENTRONIC <sup>PLUS</sup>	●	○		●				●	●		■	▲	Digital control, controller adaptation
	E SERIES	●	○		●				●		●	■		Optional 2 bit binary digital
	FLOWTRONIC <sup>D</sup>		●		●				●	●		■	▲	Digital control with or without display, controller adaptation

- **Static:** For applications with few setpoint changes
- ▲ **Dynamic:** For applications with constantly changing setpoints
- **Primary function**
- **Secondary function**



## Proportional Technology Pressure Control: Sentronic<sup>D</sup>

**NUMATICS**<sup>®</sup>

### Sentronic<sup>D</sup>

SENTRONIC<sup>D</sup> is a digitally operated pressure regulator valve.

SENTRONIC<sup>D</sup> stands for:

- Digital control
- Display (integrated)
- Direct operated valve

With the Data Acquisition Software (DaS) and the RS232 interface, it's now possible to optimally adjust the valve's control parameters to a specific application. The scope function allows you to log and read the system's response in real time.

The DaS capabilities streamline the development process and identify application-specific problems at an early stage. Saved parameters can also be used for future production so that valves are factory-set to a specific application.

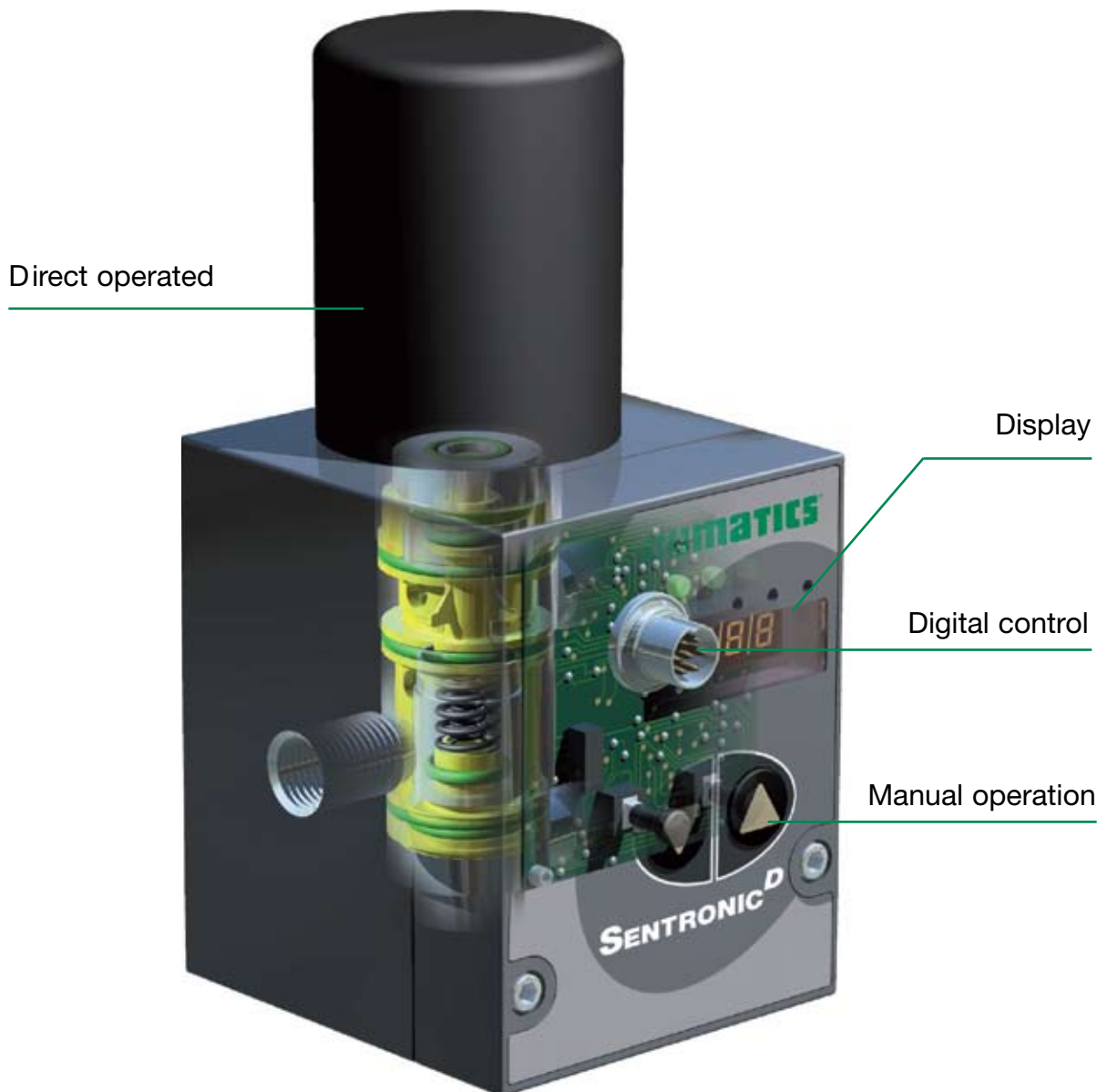

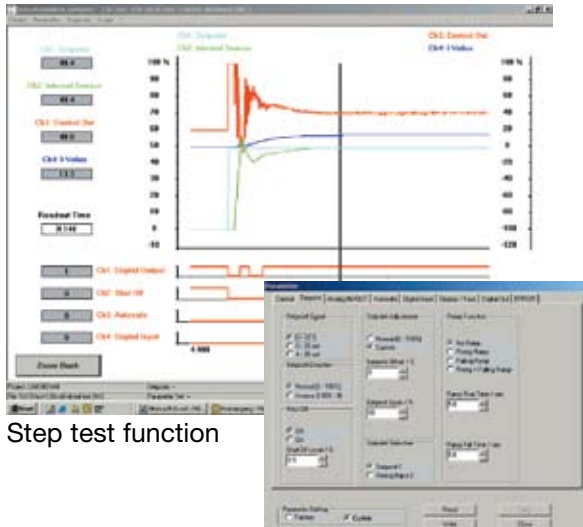

Step test function

Parameters setup

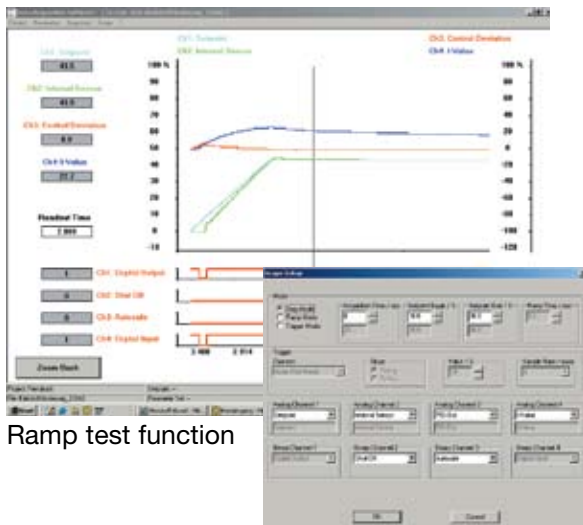

Ramp test function

Scope setup

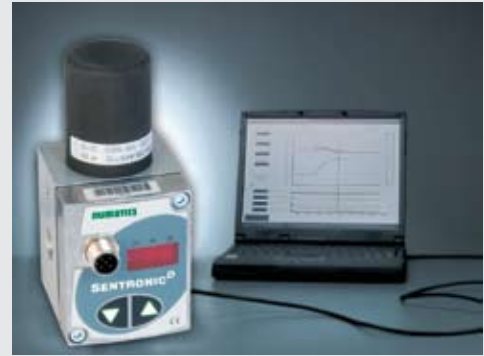

By connecting the Sentronic<sup>D</sup> to a PC with an RS232 interface, the Data Acquisition Software (DaS) can be used to optimally adjust the valve's control parameters to a specific application. DaS has an oscilloscope function that allows the user to select and visually see various response characteristics as the valve operates in an application. Control loop parameters can be adjusted using the software without removing the valve from service. This functionality streamlines the application development process. Control parameters can be saved and reloaded at any time.

The DaS software offers the following features:

- Real time display of: command signal, outlet pressure, internal control parameters (e.g. P, I or D), pressure switch signal, etc.
- Parameter setting: command signal, zero offset, span, limitation of output current, ramp function, etc.
- Diagnostics menu for error detection and testing
- Custom adjustment to an application
- Control of Sentronic<sup>D</sup>

### Advantages

- Minimum hysteresis
- Quick response times
- Very high sensitivity
- Standard 50 µm filtration
- No constant air consumption
- Analog feedback output
- Easy change of control parameters
- Digital control
- Integrated display (optionally without)
- PC communication

### Specifications

Fluids: Air or neutral gases  
 Pressure Range: 0 - 50 psi, 0 - 100 psi, 0 - 150 psi, 0 - 3 bar, 0 - 6 bar, 0 - 10 bar  
 Ports: 1/8, 1/4, 3/8 (NPT or GTap)  
 Construction: Poppet Valve  
 Actuation: Proportional Solenoid  
 Command Signal: 0 - 10 V, 0 - 20 mA, 4 - 20 mA



## Proportional Technology Pressure Control: Sentronic<sup>D</sup>



### Sentronic<sup>D</sup>

1/8 to 3/8 tapped body or 1/8 - 1/4 subbase mounted body (NPT or GTap)



#### Features

- Sentronic<sup>D</sup> is a highly dynamic 3-way proportional valve with digital control.
- Sentronic<sup>D</sup> stands for:
  - Digital communication and control
  - Display (integrated)
  - Direct operated valve
- A special feature of the Sentronic<sup>D</sup> is its DaS software supplied for optimum adjustment via PC and viewing of command and feedback signals.
- Other functions are valve diagnostics, parameter setting and maintenance.
- The valve's outlet pressure can also be adjusted over the integrated display and the function buttons.

#### Construction

Body: Aluminium  
 Internal parts: POM (polyacetal)  
 Seals: NBR (nitrile) and FPM (fluoroelastomer)

#### General

Fluids: Air or neutral gas, filtered at 50 µm, condensate-free, lubricated or unlubricated  
 Maximum allowable pressure (MAP): 90 to 190 psi (6 to 13 bar)  
 Pressure range: 0-50 psi to 0-150 psi (0-3 bar to 0-10 bar)  
 Fluid temperature: 32°F - 140°F (0°C - 60°C)  
 Ambient temperature: 32°F - 122°F (0°C - 50°C)  
 Flow (Qv at 6 bar): 470 to 1300 l/min (ANR)  
 Command signal: 0 - 10 V (impedance 100 kΩ)  
 0 - 20 mA / 4 - 20 mA (impedance 250 Ω)  
 Hysteresis: < 1% of span  
 Linearity: < 0.5% of span  
 Repeatability: < 0.5% of span  
 Minimum setpoint: 100 mV (0.2 mA/4.2mA) with shut-off function  
 Minimum outlet pressure: 1% of span

### Electrical Characteristics

NOMINAL DIAMETER DN (mm)	VOLTAGE *	MAX. POWER (W)	MAX. CURRENT (mA)	INSULATION CLASS	DEGREE OF PROTECTION	ELECTRICAL CONNECTION
4	24 VDC ±10%	21	850	H	IP 65	5-pin M12 connector (not supplied)
8	24 VDC ±10%	40	1650	H	IP 65	5-pin M12 connector (not supplied)

\* Max. ripple: 10 %

### Specifications

Ø PORTS	Ø ORIFICE DN (mm)	C <sub>v</sub> FLOW FACTOR (K <sub>v</sub> , Nm <sup>3</sup> /h)	FLOW
			AT 6 BAR (l/min - ANR)
1/8, 1/4 NPT or GTap	4	0.29 (0.25)	470
1/4, 3/8 NPT or GTap	8	0.81 (0.7)	1300

Test conditions according to ISO 8778: temperature: 20 °C, relative inlet pressure: 6 bar, relative outlet pressure: 5 bar

### How to Order

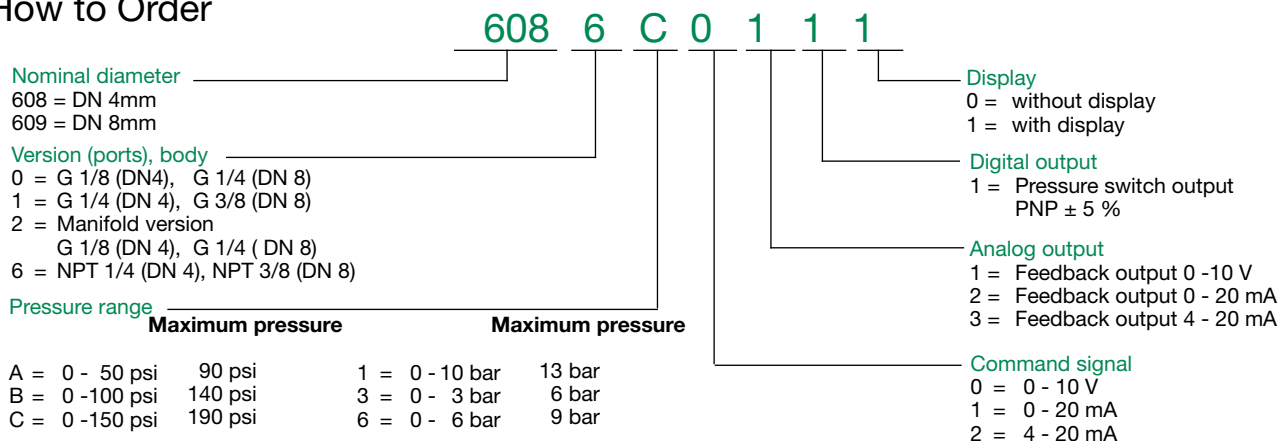





Dimensions in inches (mm), Weight in lbs (kg)

Inline version: DN 4

Weight: 1.23 (0.56)

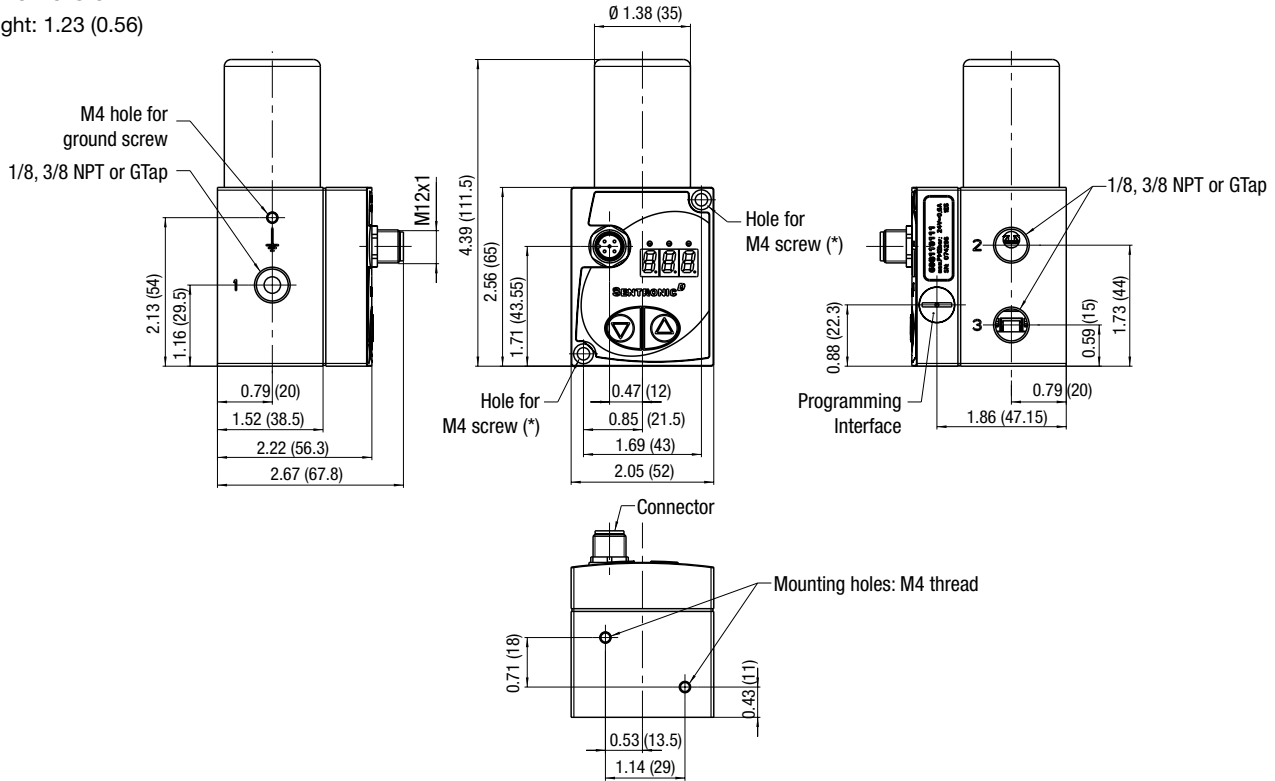

Inline version: DN 8

Weight: 2.49 (1.13)

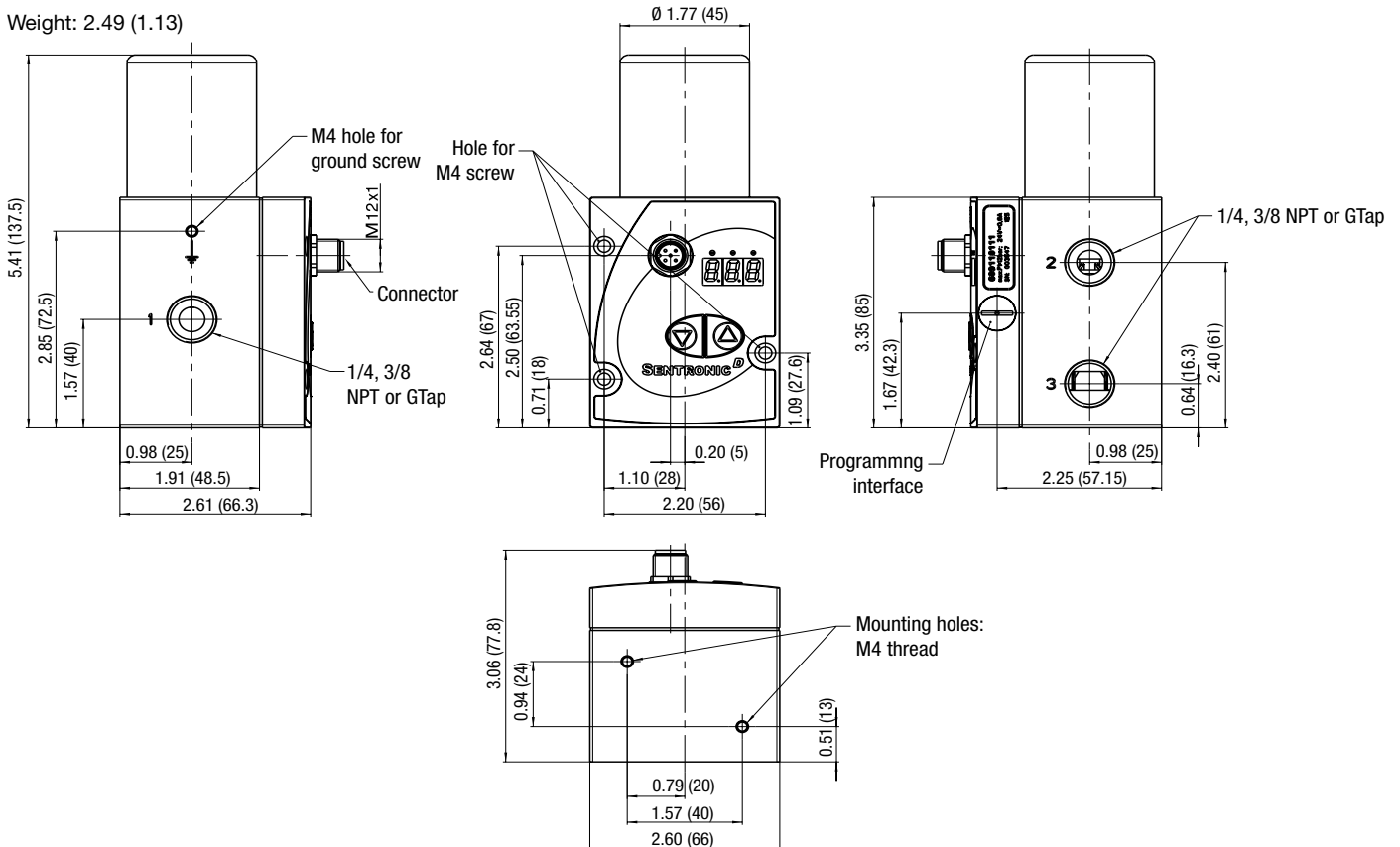



**Proportional Technology  
Pressure Control: Sentronic<sup>D</sup>**

Dimensions in inches (mm), Weight in lbs (kg)

Manifold version: DN 4

Weight: 1.23 (0.56)

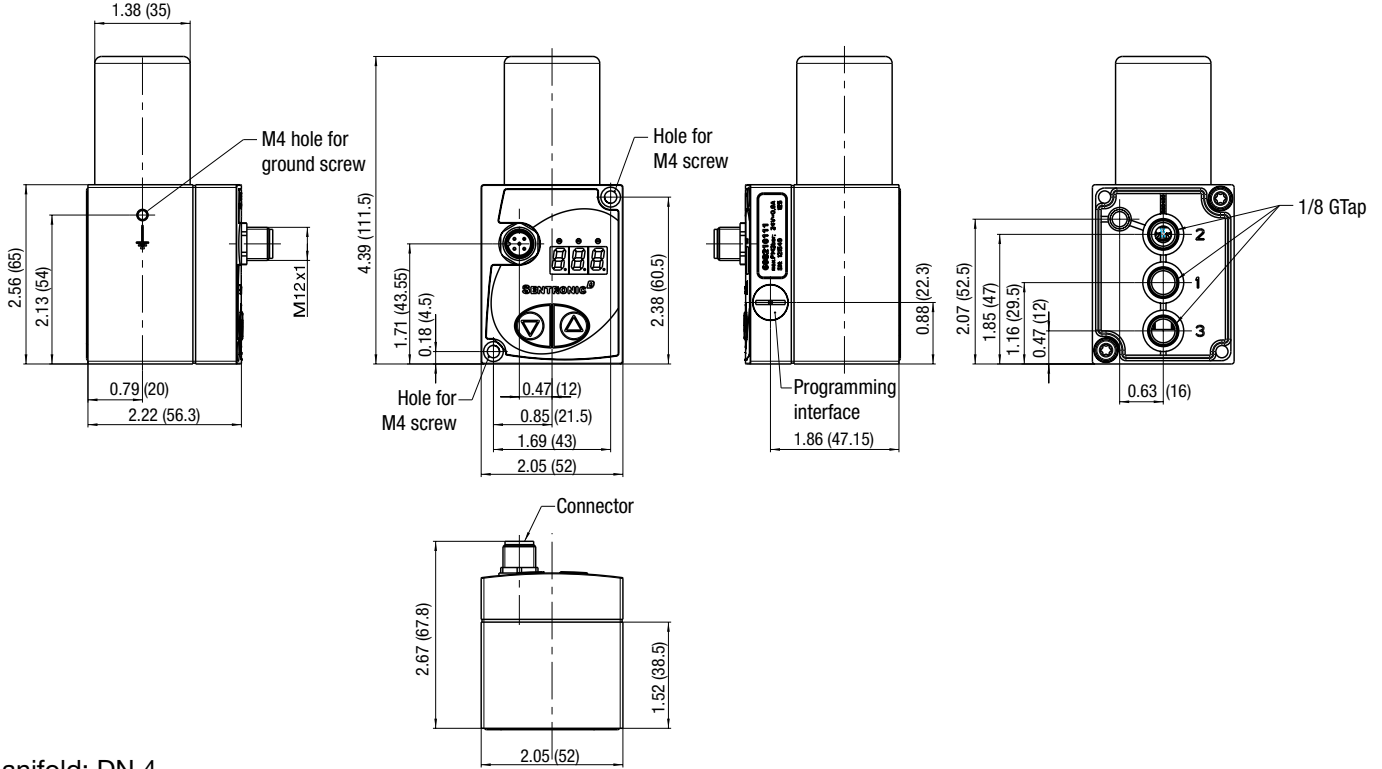

Manifold: DN 4

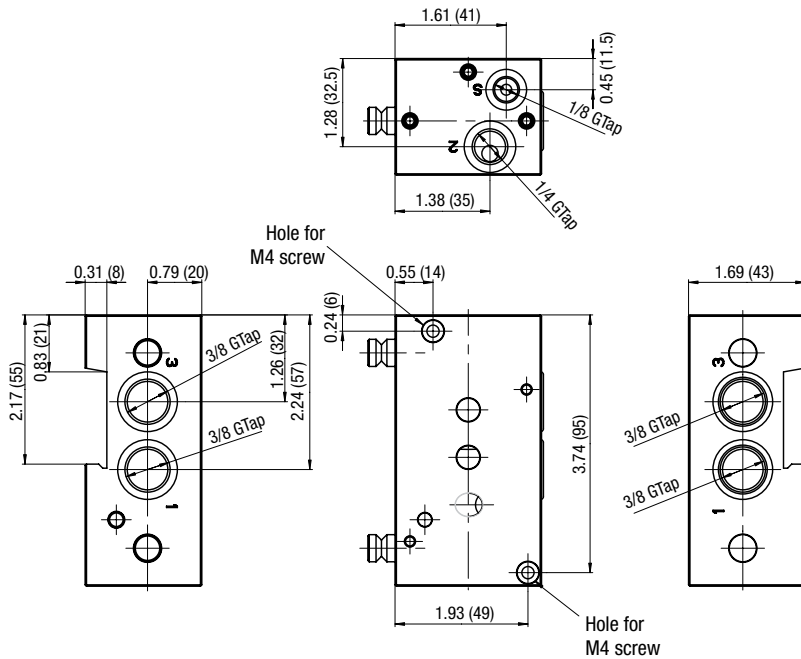



Dimensions in inches (mm), Weight in lbs (kg)

Manifold version: DN 8

Weight: 2.49 (1.13)

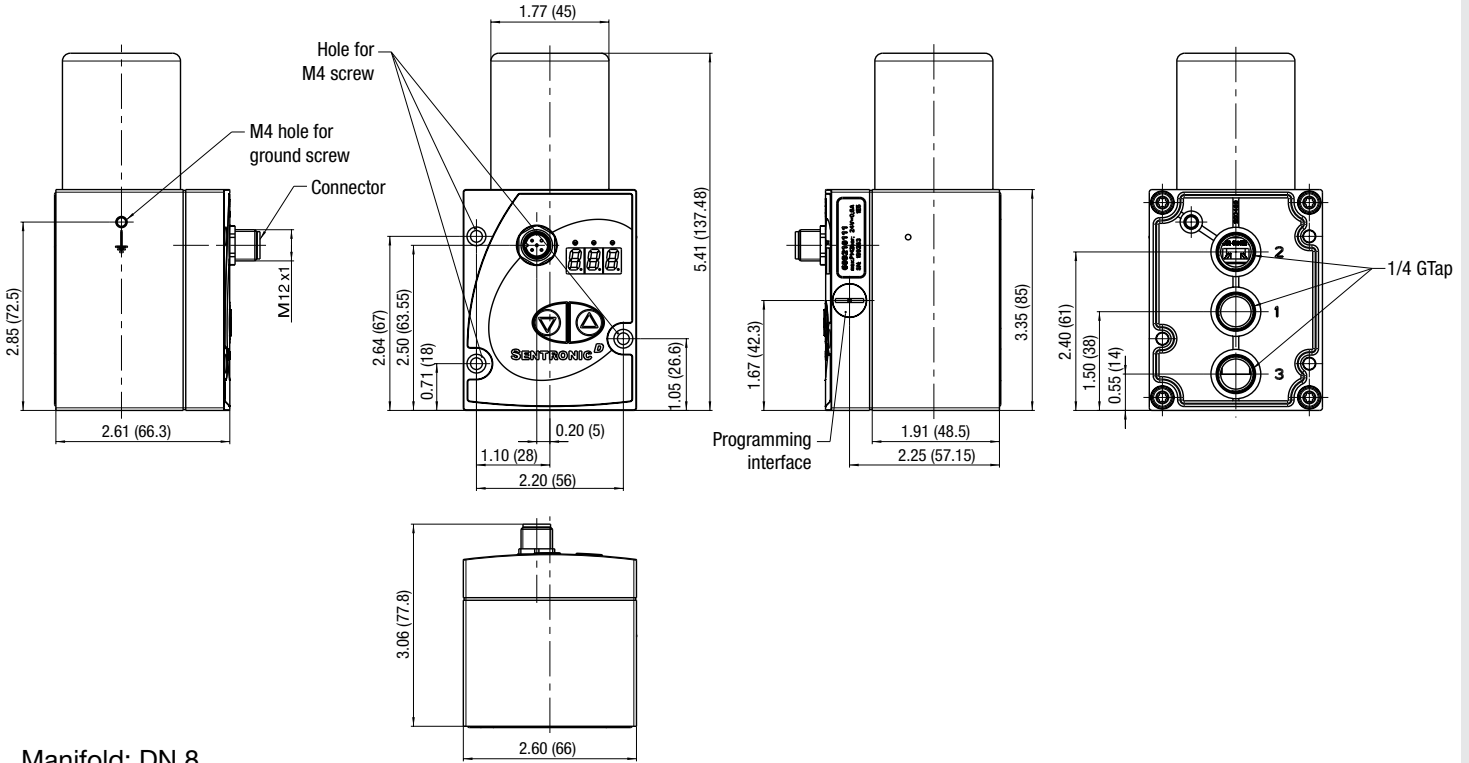

Manifold: DN 8

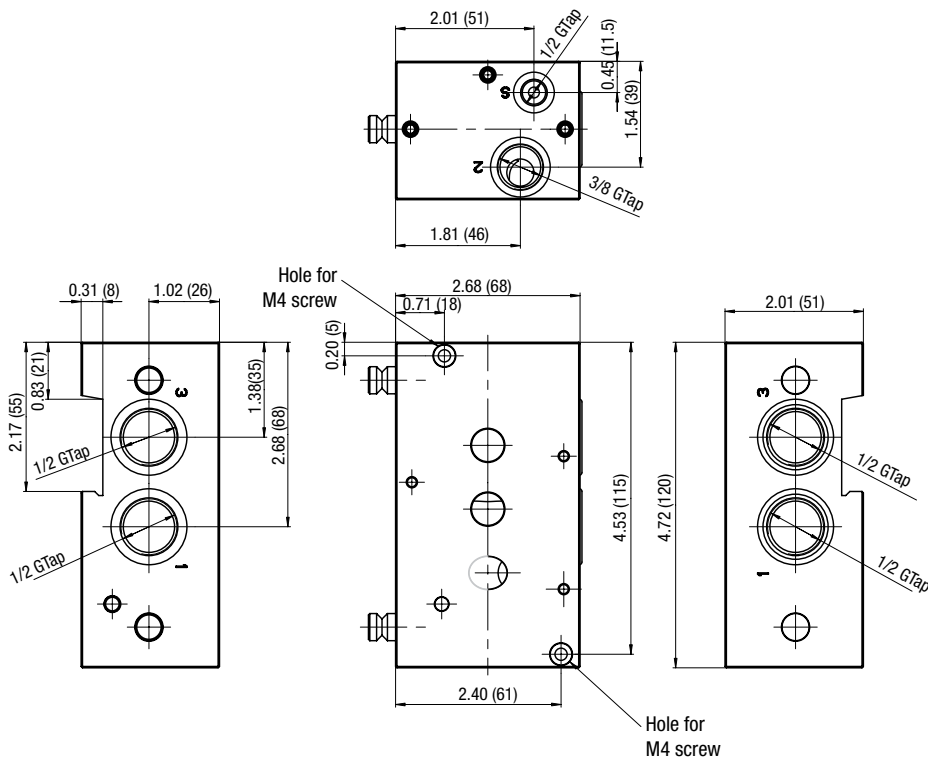



## Proportional Technology Pressure Control: Sentronic<sup>D</sup>

# NUMATICS<sup>®</sup>

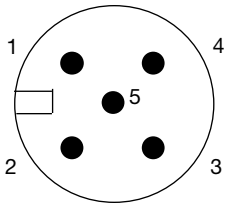

### Connector Pin Out



PIN	DESCRIPTION
1	+24 VDC Supply
2	Command Signal
3	+0 VDC Common (Supply)
	+0 VDC Common (Command Signal)*
4	Analog output (feedback)
5	Digital output (pressure switch)
Body	EMC shield

\*A 6-wire cable with separate common for the command signal is used for cable lengths over 2 m to minimize the voltage drop for the command signal.

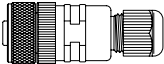
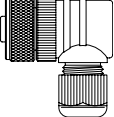
### Accessories

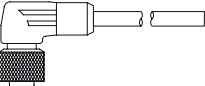
	<b>5 Pin 12mm FEMALE Straight Field Attachable Connectors</b>	<b>MODEL NUMBER</b>
	PG 9 Cable Gland	TC05F2000000000
	<b>5 Pin 12mm FEMALE 90 DEGREE Field Attachable Connectors</b>	<b>MODEL NUMBER</b>
	PG 9 Cable Gland	TD05F20000000000
	<b>Micro FEMALE 5 Pole Straight 6 Wire 22 AWG, Shielded</b>	<b>MODEL NUMBER</b>
	3 Meter	TC0503MMS000671Y
	5 Meter	TC0505MMS000671Y
	<b>Micro FEMALE 4 Pole 90 Degree 22 AWG Euro Color Code</b>	<b>MODEL NUMBER</b>
	3 Meter	TD0503MMS000671Y
	5 Meter	TD0505MMS000671Y
	<b>Manifold</b>	<b>MODEL NUMBER</b>
	Manifold for 608 (DN 4mm) with G3/8; common supply and exhaust	35500558
	Manifold for 609 (DN 8mm) with G1/2; common supply and exhaust	35500559
	<b>PC Software &amp; Cable Connectors</b>	<b>MODEL NUMBER</b>
	DaS Light: Data Acquisition Software for SENTRONIC <sup>D</sup> - basic parameters - CD-ROM	99100110
	DaS Expert: Data Acquisition Software for SENTRONIC <sup>D</sup> - full parameters - CD-ROM	99100111
	RS 232 cable converter; 2m cable with 9-pin Sub-D (plug connector)	88100732
	RS 232 cable converter; 2m cable with 9-pin Sub-D (screw connector)	833-993708



### Sentronic<sup>PLUS</sup>

Sentronic<sup>PLUS</sup> is a digitally operated pressure regulator valve. This valve accurately adjusts pressure, flow, force, speed, and linear or angular positions. All orifices have the same diameter for short response times whether increasing or exhausting pressure. The valve components are designed to provide control at an extremely low hysteresis.

The Sentronic<sup>PLUS</sup> regulates pressure up to 725 psi (50 bar) and can be used in potentially explosive atmospheres according to ATEX Directive 94/9/EC.

With the Data Acquisition Software (DaS) and the RS232 interface, it is now possible to optimally adjust the valve's control parameters to a specific application. The scope function allows you to log and read out the system's response in real time.

The DaS capabilities streamline the development process and identify application-specific problems at an early stage. Saved control parameters can be loaded at any time and used as a reference for maintenance and error detection. Saved parameters can also be used for future production so that valves are factory-set to a specific application.

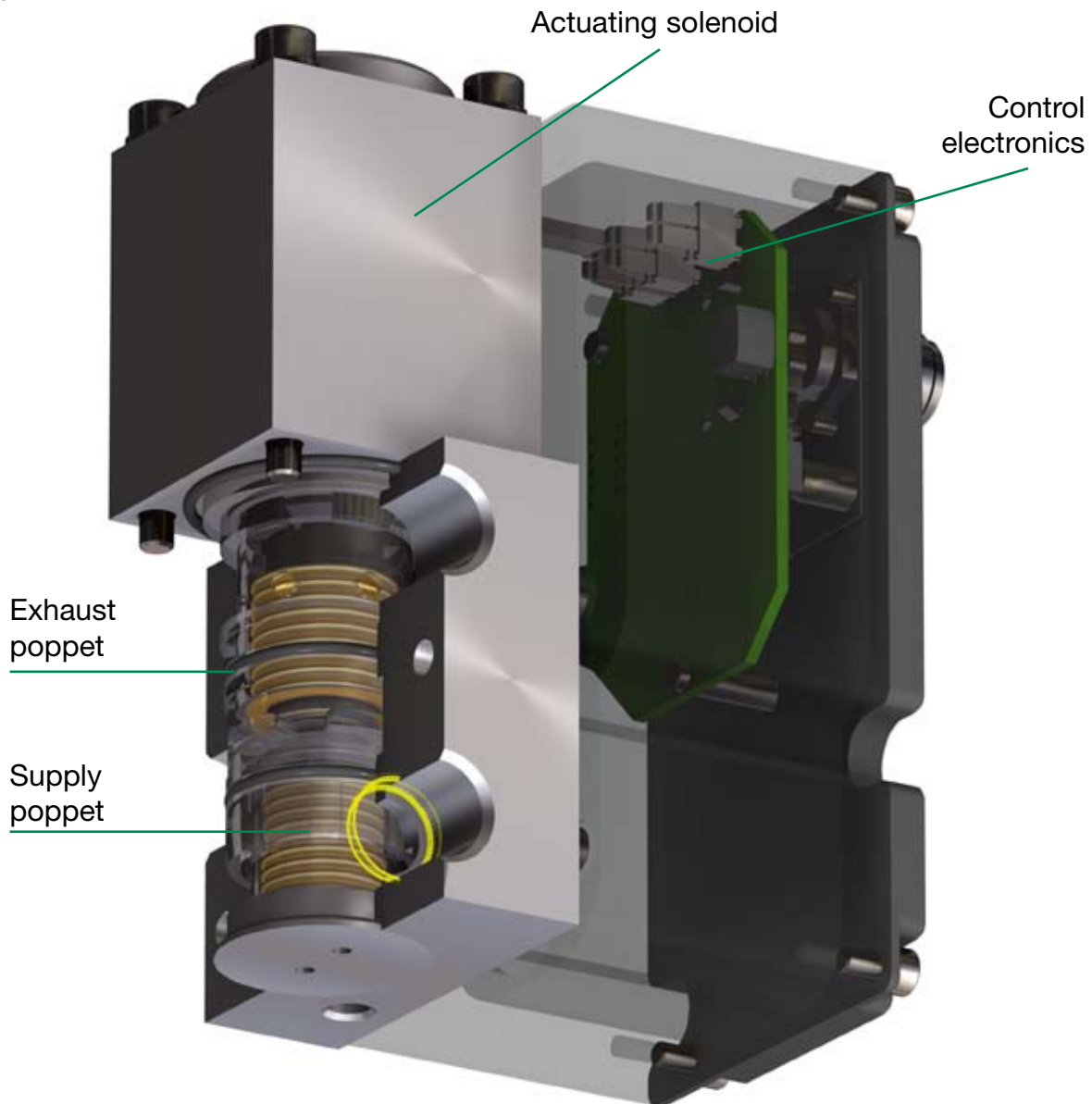



## Proportional Technology Pressure Control: Sentronic<sup>PLUS</sup>

# NUMATICS<sup>®</sup>

All SENTRONIC valves are tested before leaving our manufacturing facilities. Each valve is provided with a test certificate showing all the test results.



### Operating Principle

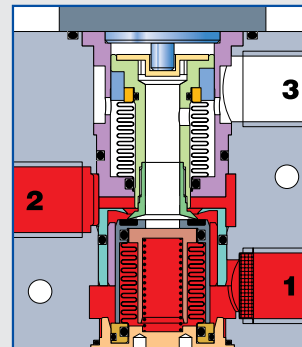

**Increasing pressure**  
The pressurization piston is operated and the flow from port 1 to port 2 is released.

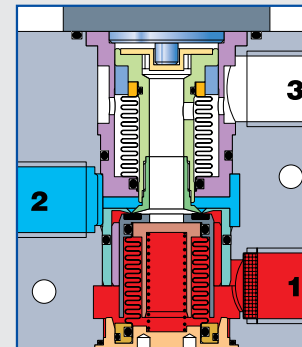

**Maintaining pressure**  
The exhaust piston is in its central position: the flow between port 2 and port 1 or port 3 is blocked.

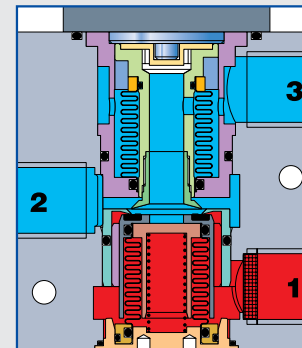

**Exhausting pressure**  
The exhaust piston is lifted and the flow from port 3 to port 2 is released.

### Advantages

- Minimum hysteresis
- Quick response times
- Very high sensitivity
- Standard 50 µm filtration
- No constant air consumption
- Analog command signal
- Analog feedback output
- PC communication
- Digital Control
- Easy change of control parameters

### Specifications

Fluids: Air and gases  
Pressure range: Vacuum to 50 bar  
Ports: 1/8, 1/4, 1/2, 1 (NPT or GTap)  
Construction: Poppet valve  
Actuation: Direct-operated solenoid  
Command signal: 0 – 10 V, 0 – 20 mA, 4 – 20 mA  
Options: Internal pressure switch  
Feedback output



### Sentronic<sup>PLUS</sup> Electronic Pressure Regulator



#### General

Sentronic<sup>PLUS</sup> is a 3-way proportional valve with digital control. Its construction allows the valve to be used in potentially explosive atmospheres according to ATEX Directive 94/9/EC. The valve also has pressure ranges from 1.5 psi to 725 psi.

The Data Acquisition Software (DaS) that comes with Sentronic<sup>PLUS</sup> can be used to adjust the valve's control parameters to a specific application. Command signal, feedback signal and control parameters can be viewed in real time and adjusted as required for an application. Settings can be saved and loaded at any time for reference or diagnostics.

#### Construction

Direct-operated poppet valve

Body: See table below

Internal parts: Stainless steel and brass

Seals: FPM (fluoroelastomer) and NBR (nitrile)

#### Specifications

Fluids: Air or neutral gas, filtered at 50 µm, condensate-free, lubricated or unlubricated

Ports: 1/8 - 1/4 - 1/2 - 1 (NPT or GTap)

Max. operating pressure: See table below

Control range: See table below

Temperature / fluid: 32°F - 140°F (0°C - 60°C)

Temperature / ambient: 32°F - 140°F (0°C - 60°C)

Command signal - analog: 0 - 10 V (impedance 100 KΩ)  
0 - 20 mA/4 - 20 mA (impedance 250 Ω)

Hysteresis: 1% of span

Linearity / pressure measurement: ± 0.5% of span

Repeatability: ± 0.5% of span

#### EXPLOSION SAFETY

Safety code:

II 2D Ex tDA21 IP65 T135°C,  
Ⓢ for use in Zone 1  
II 3G Ex nA II T4,  
Ⓢ for use in Zone 2

EC type examination certificate no.:

IBExU07ATEX1173

#### Electrical Characteristics

NOMINAL DIAMETER DN (mm)	VOLTAGE *	MAX. POWER (W)	MAX. CURRENT (mA)	INSULATION CLASS	DEGREE OF PROTECTION	ELECTRICAL CONNECTION
3	24 VDC = ±10%	12	500	F	IP 65	5-pin M12 connector
6	24 VDC = ±10%	24	1000	F	IP 65	5-pin M12 connector
12	24 VDC = ±10%	34	1400	F	IP 65	5-pin M12 connector
20	24 VDC = ±10%	44	1800	F	IP 65	5-pin M12 connector

#### Specifications

Ø PORTS	Ø ORIFICE DN (mm)	FLOW	
		C <sub>v</sub> FLOW FACTOR (K <sub>v</sub> , Nm <sup>3</sup> /h)	AT 6 BAR (l/min - ANR)
1/8 NPT or GTap	3	0.21 (0.18)	210
1/4 NPT or GTap	6	0.70 (0.60)	700
1/2 NPT or GTap	12	1.39 (1.20)	1400
1 NPT or GTap	20	5.57 (4.80)	5600

#### How to Order

8 3 3 - 3 5 7 9 0 1 1 P B

##### Version (ports), body

0 = DN6 (G 1/4), ALU	7 = DN3 (G 1/8), Brass
1 = DN12 (G 1/2), ALU <sup>2)</sup>	8 = DN6 (G 1/4), Brass
2 = DN20 (G 1), ALU	9 = DN3 (NPT 1/8"), Brass
4 = DN6 (NPT 1/4"), ALU	A = DN6 (NPT 1/4"), Brass
5 = DN12 (NPT 1/2"), ALU	C = DN6 (G 1/4), VA
6 = DN20 (NPT 1"), ALU	H = DN6 (G 1/4), Brass <sup>1)</sup>

##### Command Signal

0 = 0 ... 10 Volt
1 = 0 ... 20 mA
2 = 4 ... 20 mA

##### Feedback

1 = Feedback output 0 ... 10 Volt
2 = Feedback output 0 ... 20 mA
3 = Feedback output 4 ... 20 mA
4 = Feedback input 0 ... 10 Volt
5 = Feedback input 0 ... 20 mA
6 = Feedback input 4 ... 20 mA

##### Notes:

<sup>1)</sup> Only for pressure ranges from 30 to 50 bar <sup>2)</sup> Up to max. 10 bar <sup>3)</sup> Only for DN6 <sup>4)</sup> Only for DN6, Brass  
Other versions available on request.

##### Pressure Range

Relative pressure (psi)	Max. inlet pressure bar (psi)	Vacuum (relative)
40 = 0 - 0.1 bar (1.5)	2 (29)	V1 = 0 ... -1 bar
50 = 0 - 0.5 bar (7.3)	2 (29)	Shut-off valve
60 = 0 - 1 bar (14.5)	2 (29)	V2 = 0 ... -1 bar
02 = 0 - 2 bar (29)	3 (44)	Bypass version
03 = 0 - 3 bar (44)	8 (116)	
05 = 0 - 5 bar (73)	8 (116)	
06 = 0 - 6 bar (87)	12 (174)	
PB = 0 - 6.9 bar (100)	12 (174)	
10 = 0 - 10 bar (145)	12 (174)	
12 = 0 - 12 bar (174)	14 (203)	
16 = 0 - 16 bar <sup>3)</sup> (232)	18 (261)	
20 = 0 - 20 bar <sup>3)</sup> (290)	22 (316)	
3H = 0 - 30 bar <sup>4)</sup> (435)	40 (580)	
5H = 0 - 50 bar <sup>4)</sup> (725)	60 (870)	

##### Digital Output

1 = Pressure switch output  
PNP ± 5 %



Proportional Technology  
Pressure Control: Sentronic<sup>PLUS</sup>



Dimensions in inches (mm), Weight in lbs (kg)

1/4 NPT or GTap

Weight: 2.09 (0.95)

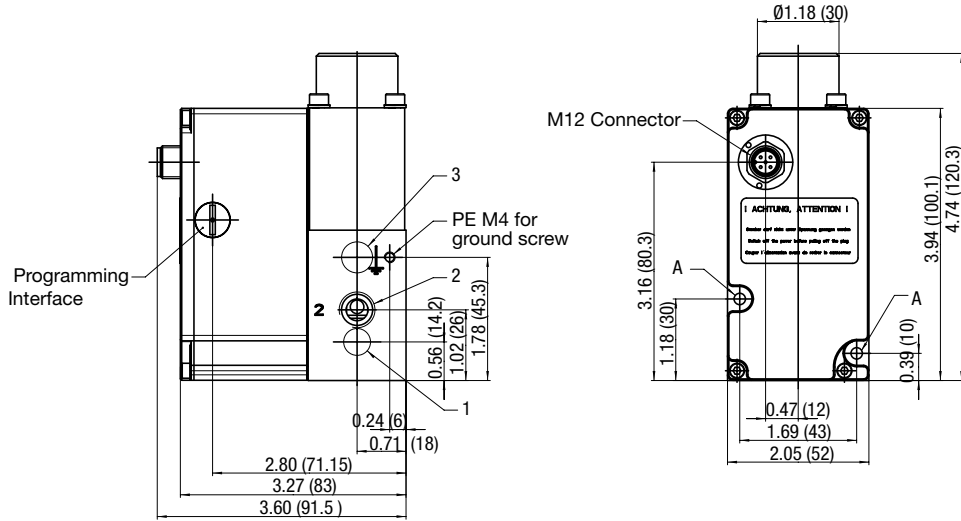

A) Thread M5 - depth 10  
(on opposite side);  
tapped through-hole  
for M4 screw.

1/2 NPT or GTap

Weight: 4.19 (1.9)

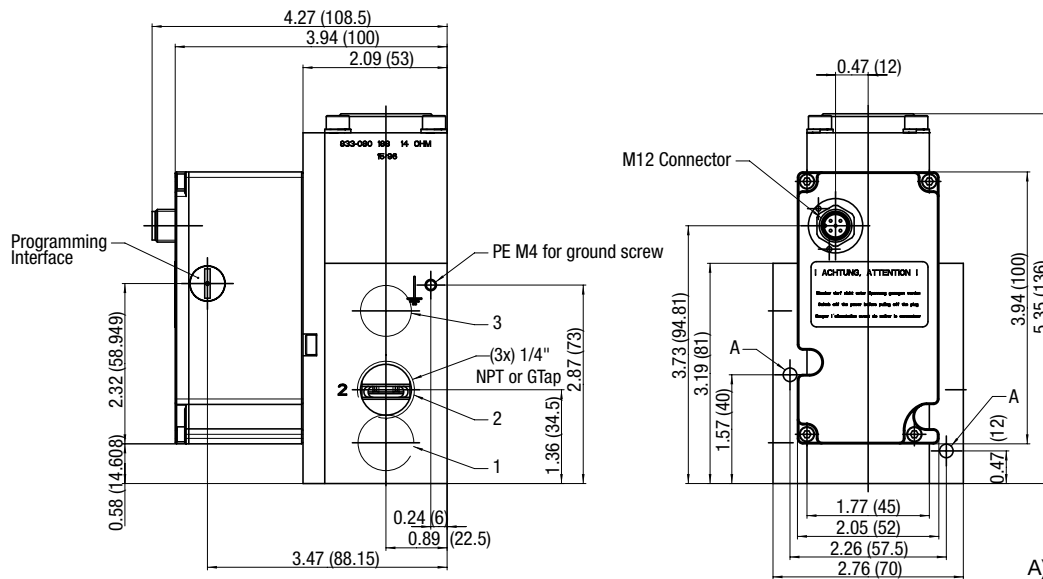

A) Thread M5 - depth 10  
(on opposite side);  
tapped through-hole  
for M4 screw.





### Dimensions in inches (mm), Weight in lbs (kg)

1 NPT or GTap

Weight: 8.60 (3.9)

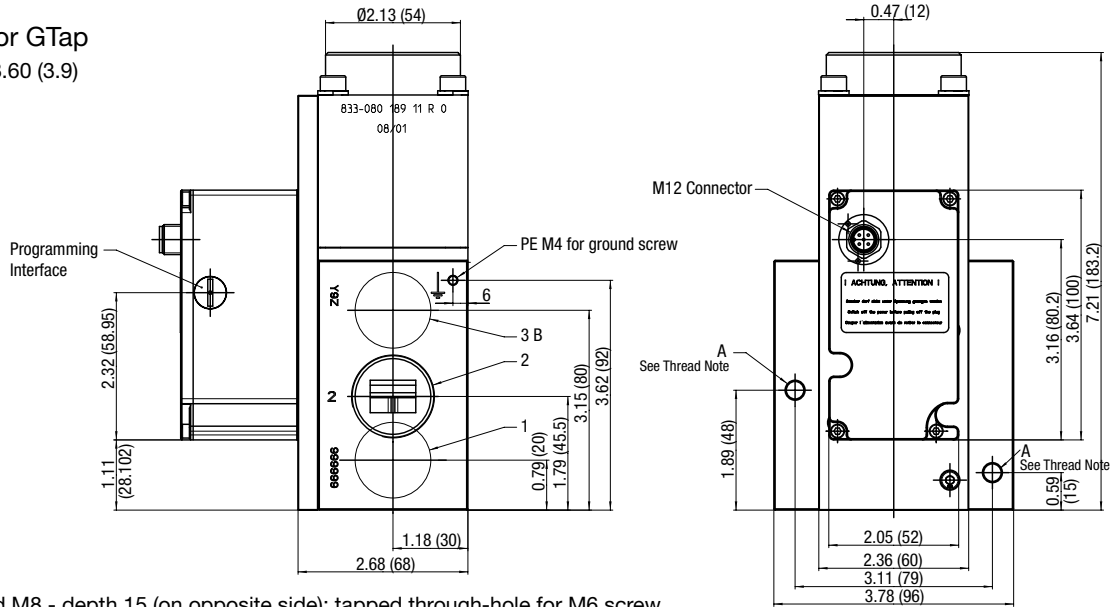

A) Thread M8 - depth 15 (on opposite side); tapped through-hole for M6 screw.  
B) The exhaust connection on the 0-16 bar version is at the bottom of the valve.

### Connector Pin Out

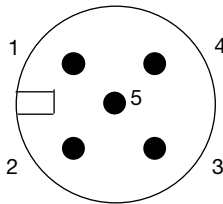

PIN	DESCRIPTION
1	+24 VDC Supply
2	Command Signal
3	+0 VDC Common (Supply)
	+0 VDC Common (Command Signal)*
4	Analog output (Feedback)
5	Digital output (Pressure switch)
Body	EMV screen

\*A 6-wire cable with separate common for the command signal is used for cable lengths over 2 m to minimize the voltage drop for the command signal.

### Accessories

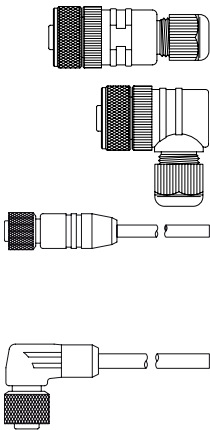

5 Pin 12mm FEMALE Straight Field Attachable Connectors	MODEL NUMBER
PG 9 Cable Gland	TC05F2000000000
5 Pin 12mm FEMALE 90 DEGREE Field Attachable Connectors	MODEL NUMBER
PG 9 Cable Gland	TD05F2000000000
Micro FEMALE 5 Pole Straight 6 Wire 22 AWG, Shielded	MODEL NUMBER
3 Meter	TC0503MMS000671Y
5 Meter	TC0505MMS000671Y
Micro FEMALE 4 Pole 90 Degree 22 AWG Euro Color Code	MODEL NUMBER
3 Meter	TD0503MMS000671Y
5 Meter	TD0505MMS000671Y
PC Software & Cable Connectors	MODEL NUMBER
DaS Light: Data Acquisition Software for SENTRONIC <sup>D</sup> - basic parameters - CD-ROM	99100110
DaS Expert: Data Acquisition Software for SENTRONIC <sup>D</sup> - full parameters - CD-ROM	99100111
RS 232 cable converter; 2m cable with 9-pin Sub-D (plug connector)	88100732
RS 232 cable converter; 2m cable with 9-pin Sub-D (screw connector)	833-993708



## Proportional Technology Pressure or Flow Control: E Series

**numatics®**

### E02/E22/E32 Series

Unlike SENTRONIC valves, E-Series valves operate with pulsed pilot valves which change the pressure in a control chamber. A pressure booster converts the pilot pressure into an outlet pressure with increased flow. The outlet pressure is measured with a pressure sensor and fed into the internal control loop. The setpoint is established over the electrical plug-in connector as a standard signal [0 to 5 (10) V, 4 to 20 mA].

E-Series is particularly suited for pressure control applications with a constant flow, e.g. flow control over nozzles, turbine speed control, glue and lacquer dosing, pressure control of welding equipment.

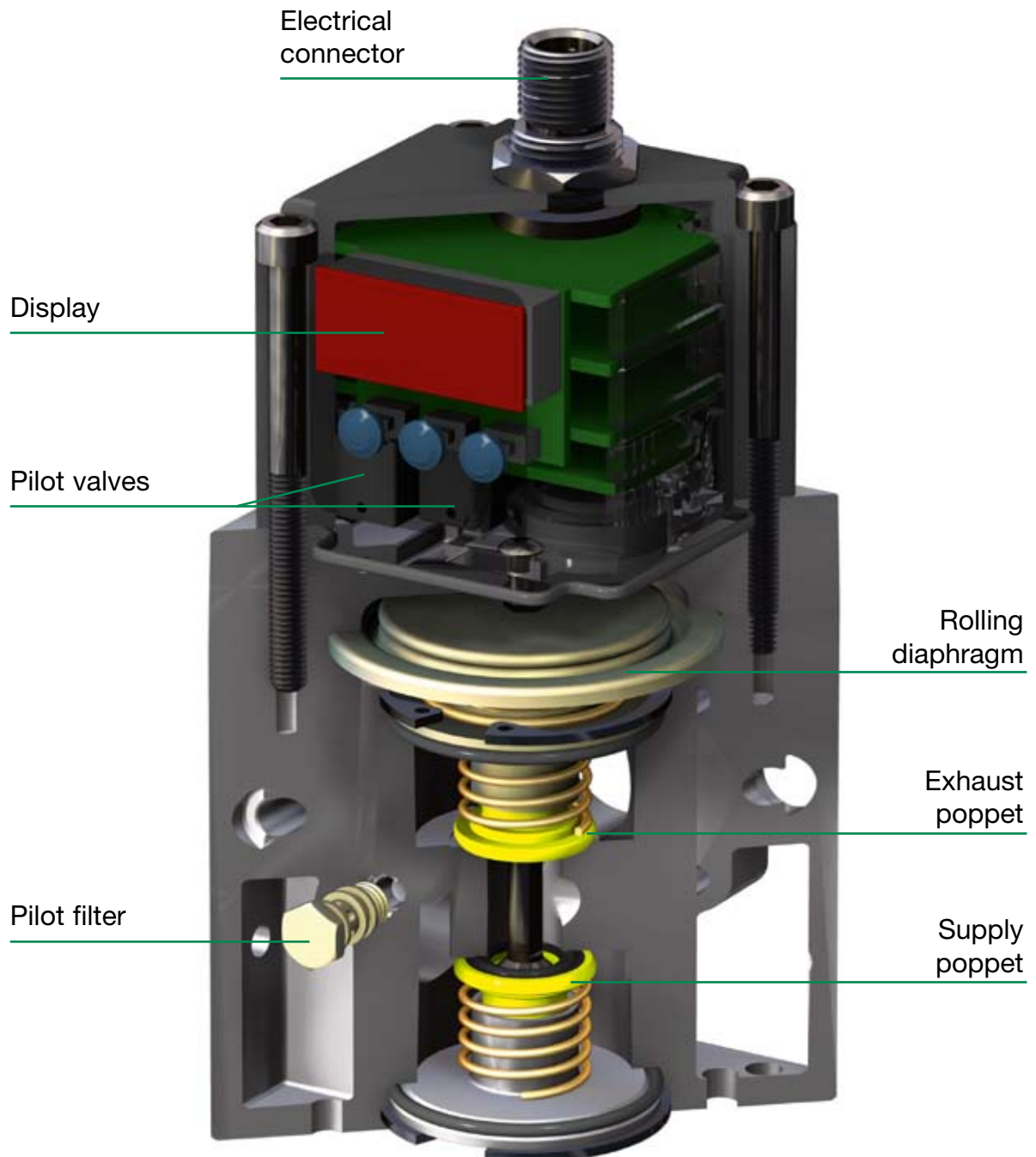



## Operating Principle

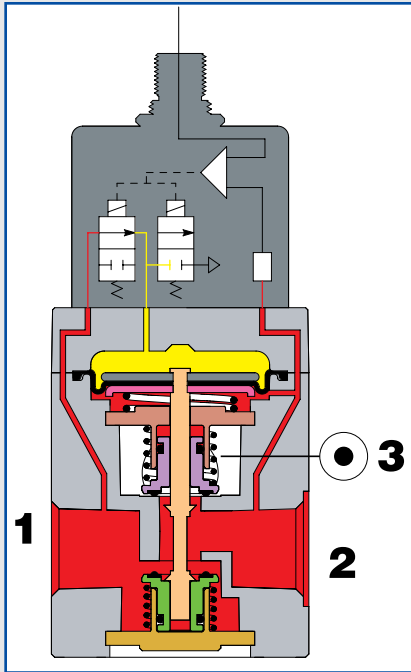

### Increasing pressure

The inlet poppet is operated and air flows from port 1 to port 2.

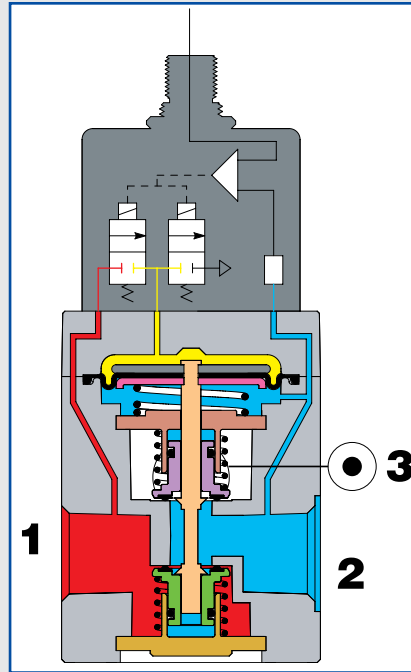

### Maintaining pressure

The poppets are in their central position: the flow between port 2 and port 1 or port 3 is blocked.

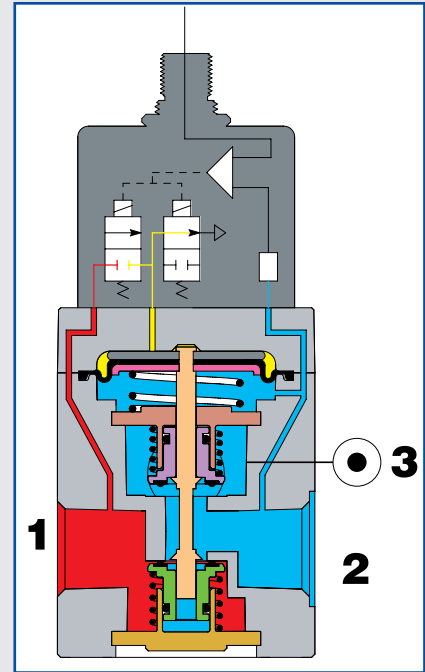

### Exhausting pressure

The exhaust poppet is lifted and air flows from port 2 to port 3.

## Specifications

Fluids: Air, neutral gases

Pressure range: 0 to 150 psi (10.2 bar)

Ports: (directly operated) 1/8, 1/4, 3/8, 1/2, 3/4 (NPT, GTap or BSPT)  
various pad-mount versions

Construction: Poppet valve

Actuation: 2 control valves

Setpoint: 0 – 10 V, 4 – 20 mA, 0 – 5 V

Options: Internal pressure switch  
Analog output (feedback)



### Introducing the E02/E22/E32 Series

The E02/E22/E32 Series electronic proportional regulators quickly and accurately adjust output pressure in relation to an electrical control signal. They meet requirements of industrial environments including rapid cycling, quick response, and repeatability, which are found in paint, welding, packaging, textile, medical, and many other process applications.

The electrical control signal can be either analog or digital. The analog unit controls any pressure setting directly proportional to the command signal of 4-20mA, 0-10VDC, or 0-5VDC. The optional digital unit uses a 2 bit binary signal to control four user defined pressures eliminating the need for an analog I/O card.



#### E02 Series Features:

- Available in 1/8 NPT, GTap or BSPT threads
- Dead-head or pilot applications (0.3 SCFM)
- Manifolder or stand-alone units
- Three outlet port options
- Three setable performance modes in a single unit
- Compact design with large LED display
- Locking feature prevents unwanted changes
- Designed to meet IP65 and NEMA 4 requirements



#### E22 Series Features:

- Available in 1/4, 3/8, and 1/2 NPT, GTap or BSPT threads
- Capable of flow up to 100 SCFM
- Modular 22 Series Flexiblok design
- Fully ported 1/2 exhaust for optimal performance
- Three setable performance modes in a single unit
- Large digital display for easy reading
- Locking feature prevents unwanted changes
- Designed to meet IP65 and NEMA 4 requirements



#### E32 Series Features:

- Available in 1/2 and 3/4 NPT, GTap or BSPT threads
- Capable of flow up to 250 SCFM
- Modular 32 Series Flexiblok design
- 1/2 exhaust for optimal performance
- Three setable performance modes in a single unit
- Large digital display for easy reading
- Locking feature prevents unwanted changes
- Designed to meet IP65 and NEMA 4 requirements



### Dimensional Drawings

#### E02 Series

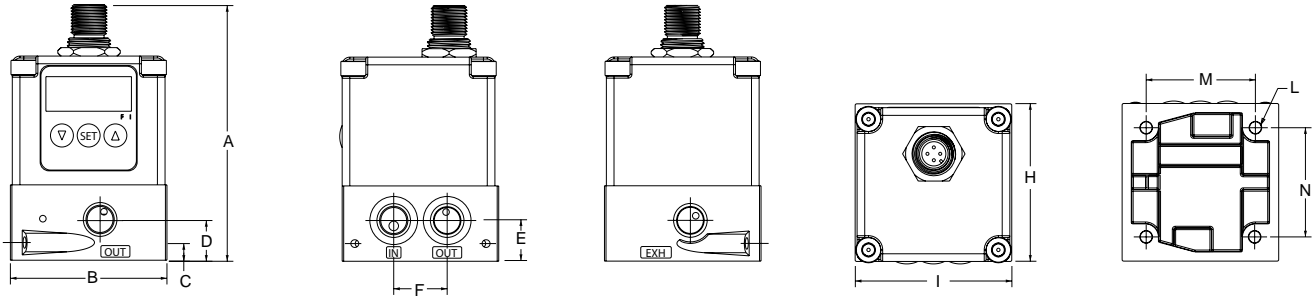

#### E22 and E32 Series

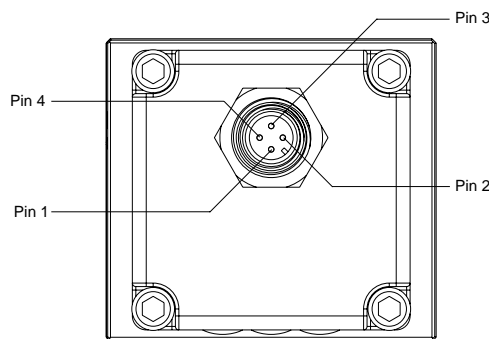
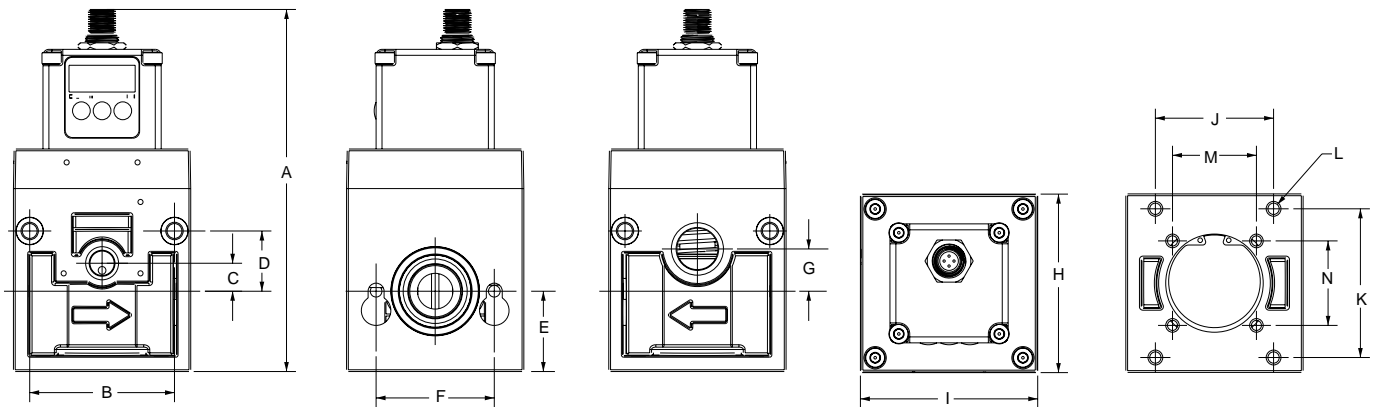

#### Pin Configuration

		Command Signal	
		Analog	Digital
Pin 1		+24VDC	
Pin 2	Command Signal		Input Signal 1
Pin 3		+0VDC common	
Pin 4	Monitor Output		Input Signal 2

Dimensions	A	B	C	D	E	F	G	H	I	J	K	L	M	N
E02	3.33 (85)	2.05 (52)	0.23 (6)	0.53 (13)	0.53 (13)	0.70 (18)	NA	2.05 (52)	2.05 (52)	NA	NA	0.80 (20)	1.42 (36)	1.42 (36)
E22	5.57 (141)	1.83 (46)	0.29 (7)	.70 (18)	1.00 (25)	1.58 (40)	0.70 (18)	2.17 (55)	2.38 (60)	1.70 (43)	1.80 (46)	0.19 (5)	1.42 (36)	1.42 (36)
E32	6.09 (155)	2.45 (62)	0.47 (12)	1.01 (26)	1.35 (34)	2.00 (51)	0.71 (18)	3.00 (76)	3.00 (76)	2.00 (51)	2.50 (64)	0.19 (5)	1.42 (36)	1.42 (36)



## Proportional Technology Pressure or Flow Control: E Series

# numatics®

### Specifications

#### Specifications

**E02**

**E22**

**E32**



		E02	E22	E32
Minimum Supply Pressure		Set Pressure + 15 PSI (1 BAR)	Set Pressure + 15 PSI (1 BAR)	Set Pressure + 15 PSI (1 BAR)
Maximum Supply Pressure		Standard Pressure: 150 PSI (10 BAR) High Pressure: 190 PSI (13 BAR)	Standard Pressure: 150 PSI (10 BAR) High Pressure: 190 PSI (13 BAR)	Standard Pressure: 150 PSI (10 BAR) High Pressure: 190 PSI (13 BAR)
Regulating Pressure Ranges		Standard Pressure: 0-100 PSI (0-6.9 BAR) High Pressure: 0-150 PSI (0-10.2 BAR)	Standard Pressure: 0-100 PSI (0-6.9 BAR) High Pressure: 0-150 PSI (0-10.2 BAR)	Standard Pressure: 0-100 PSI (0-6.9 BAR) High Pressure: 0-150 PSI (0-10.2 BAR)
Power Supply	Voltage	24VDC ±10%	24VDC ±10%	24VDC ±10%
	Current Consumption	0.04 A	0.04 A	0.04 A
Input Signal	Current	4-20mA	4-20mA	4-20mA
	Voltage	0-5VDC, 0-10VDC	0-5VDC, 0-10VDC	0-5VDC, 0-10VDC
Input Impedance	0-5 VDC	10 KΩ	10 KΩ	10 KΩ
	0-10 VDC	20 KΩ	20 KΩ	20 KΩ
	4-20 mA	100 Ω	100 Ω	100 Ω
Output Signal	Analog Output	0-5VDC 0-10VDC 4-20mA	0-5VDC 0-10VDC 4-20mA	0-5VDC 0-10VDC 4-20mA
	Switch Output	24VDC (PNP or NPN)	24VDC (PNP or NPN)	24VDC (PNP or NPN)
Linearity		≤ ±1% of span	≤ ±1% of span	≤ ±1% of span
Hysteresis		≤ ±.5% of span	≤ ±.5% of span	≤ ±.5% of span
Repeatability		≤ ±.5% of span	≤ ±.5% of span	≤ ±.5% of span
Sensitivity		≤ ±.2% of span	≤ ±.2% of span	≤ ±.2% of span
Temp Characteristics		±.5% of span /°C	±.5% of span /°C	±.5% of span /°C
Output Display	Accuracy	±3% of span	±3% of span	±3% of span
	Minimum unit	PSI 0.1, BAR 0.01, kPa 001., kgf/cm <sup>2</sup> 0.01	PSI 0.1, BAR 0.01, kPa 001., kgf/cm <sup>2</sup> 0.01	PSI 0.1, BAR 0.01, kPa 001., kgf/cm <sup>2</sup> 0.01
Temperature Range		40-120°F 4-50°C	40-120°F 4-50°C	40-120°F 4-50°C
Enclosure		IP65 and NEMA 4 Equivalent	IP65 and NEMA 4 Equivalent	IP65 and NEMA 4 Equivalent
Weight		0.68 lbs (0.31kg)	1.4 lbs (0.64kg)	2.34 lbs (1.06kg)



### How to Order

**E 22 3 - 04 3 H**

#### Series

- 02 = 02 Series
- 22 = 22 Series
- 32 = 32 Series

#### Command Signal

- 1 = 4 - 20mA
- 2 = 0 - 5VDC
- 3 = 0 - 10VDC
- 9 = 2 bit, 4 pressure select (PNP sourcing)
- 0 = 2 bit, 4 pressure select (NPN sinking)

#### Thread Types

- = NPTF
- G = GTap (BSPP)
- R = PT (BSPT)

#### Options

- H = 0 - 150 PSI (10 BAR) regulating pressure range  
(For 0-100 PSI standard unit no suffix necessary)

#### Feedback Signal

- 1 = 4 - 20mA
- 2 = 0 - 5VDC
- 3 = 0 - 10VDC
- 8 = 24VDC Switched (PNP)
- 9 = 24VDC Switched (NPN)
- 0 = use with 2 bit, 4 pressure select  
(type 9 or 0 input signal)

#### Port Tap Size

- 01 = 1/8 (E02 Series Only)
- 02 = 1/4 (E22 Series Only)
- 03 = 3/8 (E22 Series Only)
- 04 = 1/2 (E22 & E32 Series Only)
- 06 = 3/4 (E32 Series Only)

### Accessories

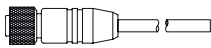

#### Micro Female 4 Pole Straight 22 AWG Euro Color Code

Unshielded	Shielded
2 Meter - TC0403MIE0000000	3 Meter - TC0403MME0000000
5 Meter - TC0405MIE0000000	5 Meter - TC0405MME0000000

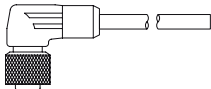

#### Micro Female 4 Pole 90 Degree 22 AWG Euro Color Code

Unshielded	Shielded
2 Meter - TD0403MIE0000000	3 Meter - TD0403MME0000000
5 Meter - TD0405MIE0000000	5 Meter - TD0405MME0000000

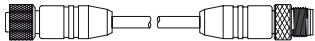

#### Micro F/M 4 Pole Straight 22 AWG Euro Color Code

Unshielded	Shielded
2 Meter - TC0403MIETA04000	3 Meter - TC0403MMETA04000
5 Meter - TC0405MIETA04000	5 Meter - TC0405MMETA04000

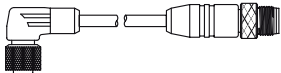

#### Micro F 90°/M Straight 22 AWG Euro Color Code

Unshielded	Shielded
2 Meter - TD0403MIETA04000	3 Meter - TD0403MMETA04000
5 Meter - TD0405MIETA04000	5 Meter - TD0405MMETA04000

### Bracket/Muffler Kits

Model Number	Description
BRK-KIT-L	Includes (1) E32-10 Bracket, (4) E32-11 Screws, (1) M4MN Muffler, (1) E22-29 Elbow
BRK-KIT	Includes (1) E02-10 Bracket, (4) E32-11 Screws, (1) M4MN Muffler, (1) E22-29 Elbow
BRK-KIT-WOEM	Includes (1) E02-10 Bracket, (4) E32-11 Screws
BRK-KIT-LWOE	Includes (1) E32-10 Bracket, (4) E32-11 Screws, (1) M4MN Muffler

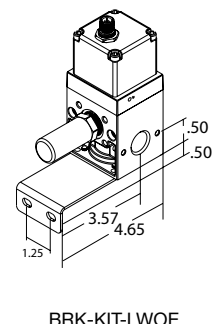
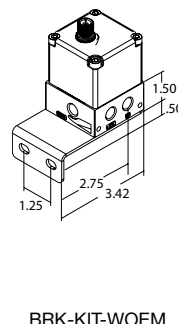
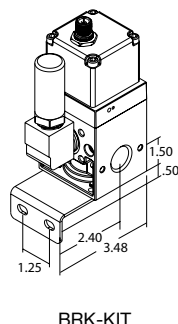
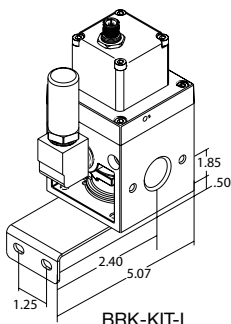



## Proportional Technology Flow Control: Flowtronic<sup>D</sup>

**NUMATICS**<sup>®</sup>

### Flowtronic<sup>D</sup>

FLOWTRONIC<sup>D</sup> is a digitally operated flow controller up to 35 SCFM (1000 NI/min). The FLOWTRONIC<sup>D</sup> consists of a fast, direct-operated 2-port proportional valve that operates independently of the inlet pressure (max. 116 psi), and a control unit which contains all of the control electronics and sensors. The FLOWTRONIC<sup>D</sup> offers precise flow adjustment and is very responsive to outside disturbances.

Typical applications for the FLOWTRONIC<sup>D</sup> include: Paint coating technology, mixing of gases in process control, packaging and food processing industry, surface finishing and materials coating processes, burner control systems, fuel cell technology.

The digital control electronics and a USB interface allow the controller to be adapted to different applications. The Numatics FlowCom PC software provides easy start-up.

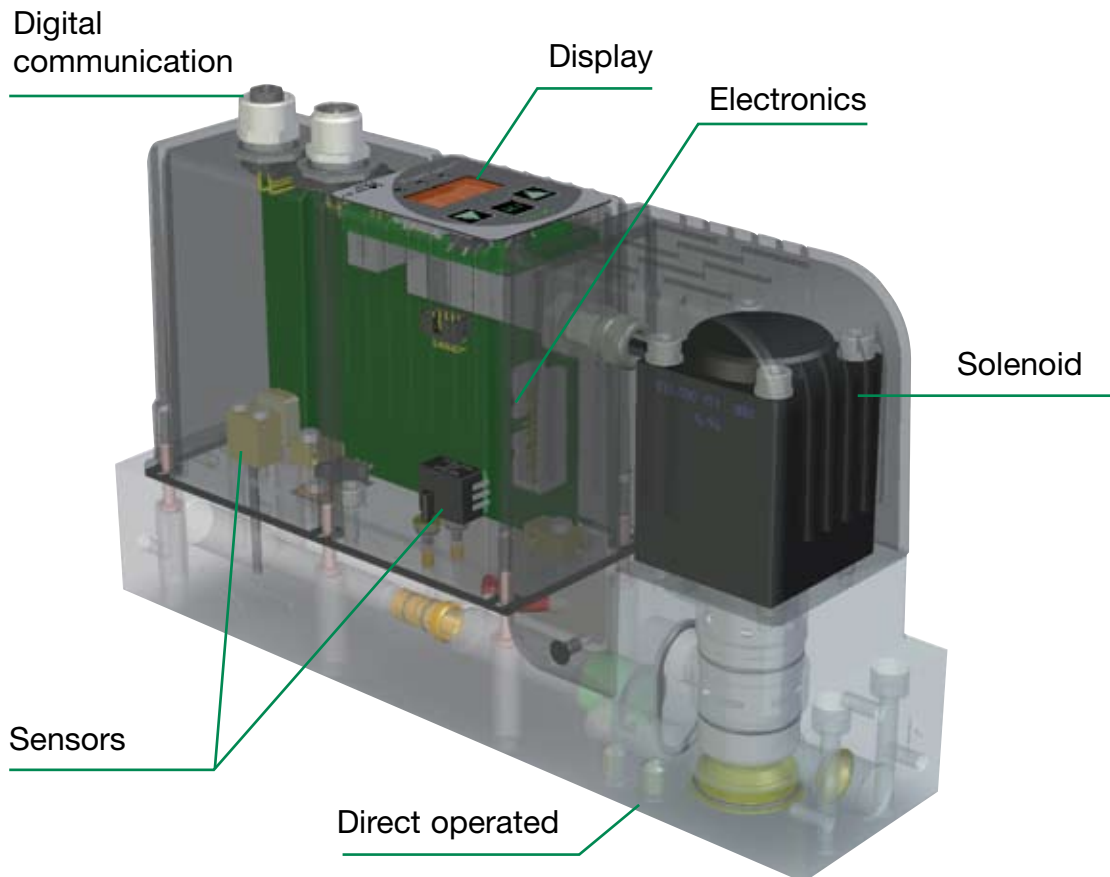



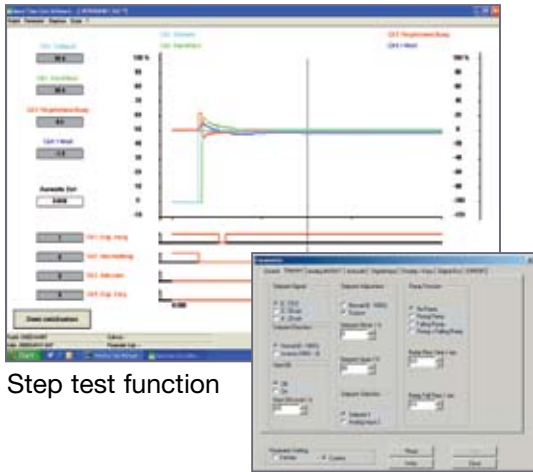

Step test function

Parameters setup

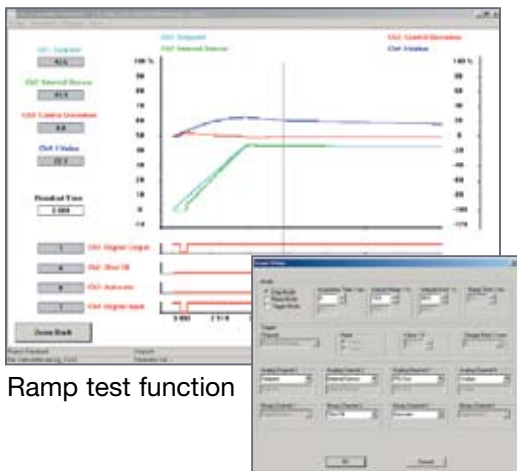

Ramp test function

Scope setup

### Advantages

- Low hysteresis
- Quick response times
- Very high sensitivity
- Standard 50 µm filtration
- Analog feedback output
- Easy change of control parameters
- Digital control
- Integrated display (optionally without)
- PC communication

### Specifications

Fluids: Air or neutral gases  
 Pressure Up to 116 psi (8 bar)  
 Ports: 1/4, 3/8 NPT or GTap  
 Nominal diameter: 3mm, 5mm, 6mm  
 Flow: 3.5 – 70.6 SCFM (100 – 2000 NI/min)  
 Valve Type: Poppet Valve  
 Command signal: 0 - 10 V, 0 - 20 mA, 4 - 20 mA  
 Feedback output: 0 - 10 V, 0 - 20 mA, 4 - 20 mA  
 Hysteresis: ± 3%  
 Linearity: 3%  
 Repeatability: ± 1.5%  
 Response time: < 200ms  
 Degree of protection: IP 65

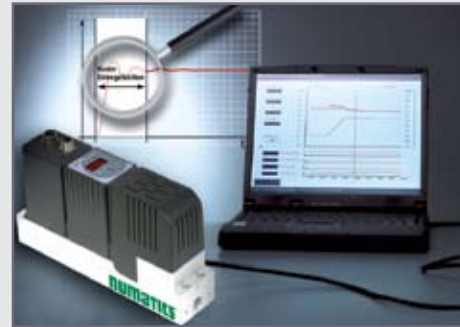

By connecting the Flowtronic<sup>D</sup> to a PC with a USB interface, the Numatics FlowCom software can be used to optimally adjust the valve's control parameters to a specific application. FlowCom software has an oscilloscope function that allows the user to select and visually see various response characteristics as the flow controller operates in an application. Control loop parameters can be adjusted using the software without removing the flow controller from service. This functionality streamlines the application development process. Control parameters can be saved and reloaded at any time.

The Numatics FlowCom software offers the following features:

- Real time display of: command signal, outlet pressure, internal control parameters (e.g. P, I or D), pressure switch signal, etc.
- Parameter setting: command signal, zero offset, span, limitation of output current, ramp function, etc.
- Diagnostics menu for error detection and testing
- Custom adjustment to an application
- Control of Flowtronic<sup>D</sup>



## Proportional Technology Flow Control: Flowtronic<sup>D</sup>

**NUMATICS**<sup>®</sup>

### Flowtronic<sup>D</sup>



#### Features

- The Flowtronic<sup>D</sup> consists of a fast, direct-acting 2-port proportional valve, a pressure sensor unit and digital control electronics.
- Controls applications that have varying flow
- Controls and maintains constant and even flow despite external disturbances such as fluctuating inlet pressure
- Measures flow precisely with two sensors
- Software and PC connection allows parameters to be adjusted to a specific application
- FlowCom software provides quick and easy start-up
- Diagnostic capability using the integrated LEDs or the FlowCom software

#### General

Fluids: Air or neutral gas, filtered at 50 µm, condensate-free, lubricated or unlubricated  
 Minimum allowable pressure: 4 bar (58 psi)  
 Maximum allowable pressure (MAP): 8 bar (116 psi)  
 Control range: 3.5 – 70.6 SCFM (100 – 2000 NI/min) (ANR)  
 Fluid temperature: 0°C to +50°C  
 Ambient temperature: 0°C to +40°C  
 Input - analog: 0 - 10 V (100 kΩ)  
 0/4 to 20 mA (resistance 250 Ω)  
 Feedback - analog: 0 - 10 V,  
 0/4 to 20 mA (max load 500 Ω)  
 Flow accuracy  
 Hysteresis: ± 3%  
 Linearity: ± 3%  
 Repeatability: ± 1.5%  
 Calibration conditions  
 Ambient temperature: 72.5°F ± 4.5°F (22.5°C ± 2.5°C)  
 Fluid: Air  
 Dynamic performance  
 Response time < 200 ms  
 Other features Auto-tune, error display by LED

#### Construction

Body: Aluminium  
 Internal parts: Aluminum, stainless steel and brass  
 Seals: NBR (nitrile)

#### Electrical Characteristics

NOMINAL DIAMETER DN (mm)	VOLTAGE *	MAX. POWER (W)	MAX. CURRENT (mA)	INSULATION CLASS	DEGREE OF PROTECTION	ELECTRICAL CONNECTION
3 and 5	24 VDC = ± 10%	30	1250	H	IP 65	- 5-pin M12 connector - USB connection with 4 pin M12 connector
6	24 VDC = ± 10%	44	1800	H	IP 65	- 5-pin M12 connector - USB connection with 4 pin M12 connector

\* Max. ripple: 10 %



### How to Order

8 3 3 - 3 8 0 1 0 1 1 5 0

#### Version (ports), body / Display

- 0 = (G thread) without display\*
- 1 = (G thread) with display\*
- 2 = 1/2 (G thread) without display
- 3 = 1/2 (G thread) with display
- 6 = (NPT) without display\*
- 7 = (NPT) with display\*
- 8 = 1/2 (NPT) without display
- 9 = 1/2 (NPT) with display
- \* Port size depends on flow range (1/4 or 3/8)

#### Command signal

- 0 = 0 ... 10 Volt
- 1 = 0 ... 20 mA
- 2 = 4 ... 20 mA

#### Feedback

- 1 = 0 ... 10 Volt
- 2 = 0 ... 20 mA
- 3 = 4 ... 20 mA
- 4 = Feedback input 0 - 10 Volt
- 5 = Feedback input 0 - 20 mA
- 6 = Feedback input 4 - 20 mA

#### Flow regulation range

- 10 = 0.4 - 3.5 SCFM (10 - 100 NI/min)  
(1/4 - Versions 0, 1, 6 or 7 only)
- 20 = 0.4 - 7.1 SCFM (10 - 200 NI/min)  
(1/4 - Versions 0, 1, 6 or 7 only)
- 30 = 0.4 - 10.6 SCFM (12 - 300 NI/min)  
(1/4 - Versions 0, 1, 6 or 7 only)
- 50 = 0.7 - 17.7 SCFM (20 - 500 NI/min)  
(1/4 - Versions 0, 1, 6 or 7 only)
- 60 = 0.8 - 21.2 SCFM (22 - 600 NI/min)  
(1/4 - Versions 0, 1, 6 or 7 only)
- 99 = 1.8 - 35.3 SCFM (50 - 1000 NI/min)  
(3/8 - Versions 0, 1, 6 or 7 only)
- 20 = 3.5 - 70.6 SCFM (100 - 2000 NI/min)  
(1/2 - Versions 2,3,8 or 9 only)

#### Digital I/O

- 1 = Digital output

### Connector Pin Out

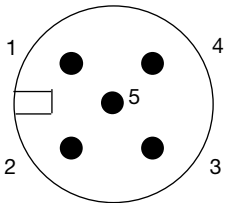

PIN	DESCRIPTION
1	+24 VDC Supply
2	Command Signal
3	+0 VDC Common (Supply)
	+0 VDC Common (Command Signal)*
4	Analog output (feedback)
5	Digital output (pressure switch)
Body	EMC shield

\*A 6-wire cable with separate common for the command signal is used for cable lengths over 2 m to minimize the voltage drop for the command signal.



## Proportional Technology Flow Control: Flowtronic<sup>D</sup>

**NUMATICS**

Dimensions in inches (mm), Weight in lbs (kg)

Weight: 4.08 (1.85)

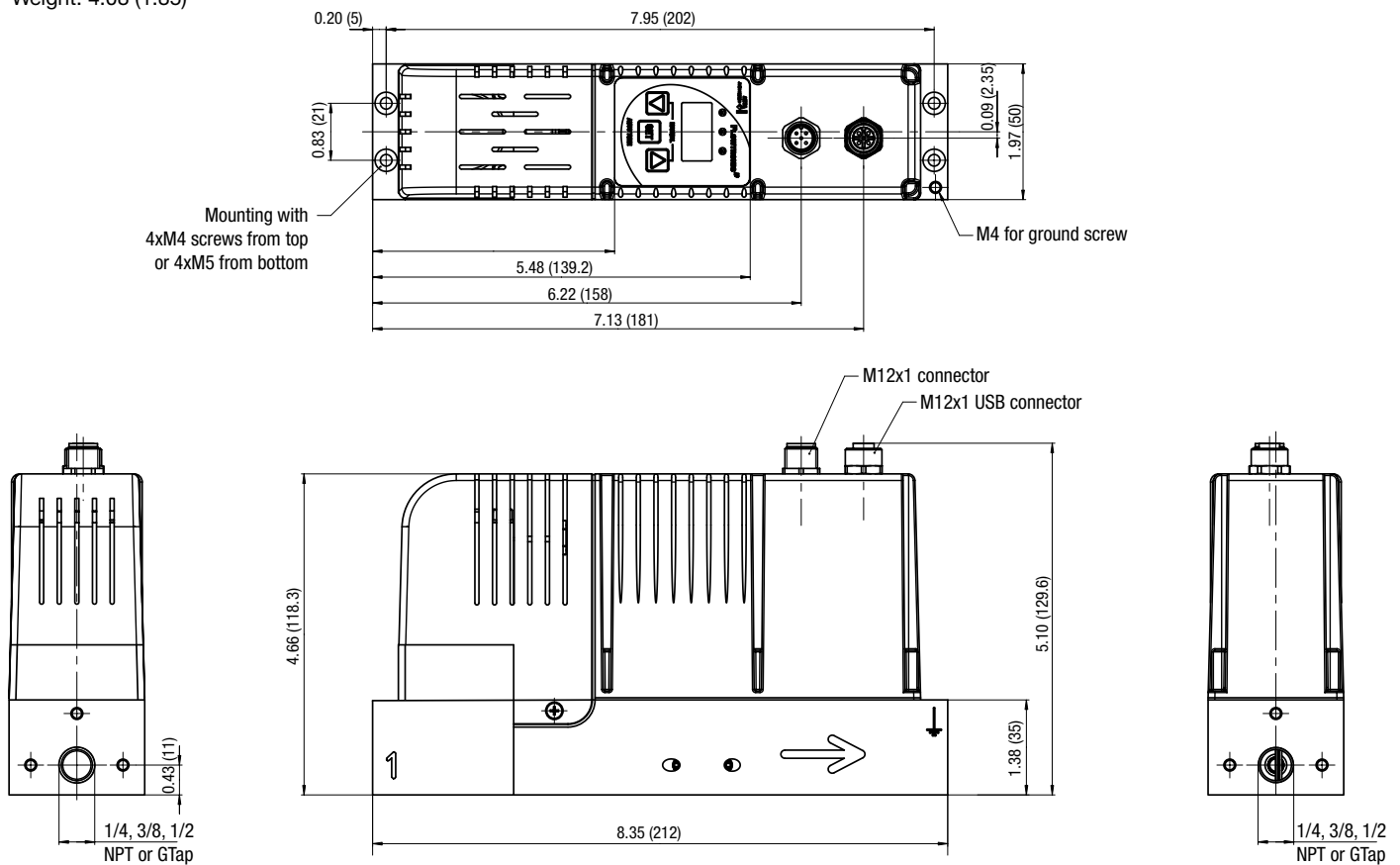

## Accessories

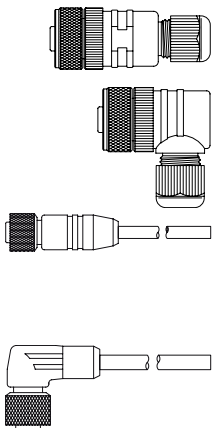

<b>5 Pin 12mm FEMALE Straight Field Attachable Connectors</b>	<b>MODEL NUMBER</b>
PG 9 Cable Gland	TC05F2000000000
<b>5 Pin 12mm FEMALE 90 DEGREE Field Attachable Connectors</b>	
PG 9 Cable Gland	TD05F2000000000
<b>Micro FEMALE 5 Pole Straight 6 Wire 22 AWG, Shielded</b>	
3 Meter	TC0503MMS000671Y
5 Meter	TC0505MMS000671Y
<b>Micro FEMALE 4 Pole 90 Degree 22 AWG Euro Color Code</b>	
3 Meter	TD0503MMS000671Y
5 Meter	TD0505MMS000671Y
<b>PC Software &amp; Cable Connector</b>	<b>MODEL NUMBER</b>
FLOWTRONIC <sup>D</sup> software "Numatics-FlowCom-Light" - CD-ROM	88100895
FLOWTRONIC <sup>D</sup> software "Numatics-FlowCom-Expert" - CD-ROM	88100896
USB cable for connection of FLOWTRONIC <sup>D</sup> to PC	88100897



### Control<sup>D</sup>

The stand-alone control device CONTROL<sup>D</sup> is used for open-loop, closed-loop or dual-loop (cascaded) process control. It is designed to control proportional valves by regulating the current in the valve's solenoid coil. The maximum value of the solenoid coil's current is automatically determined with the auto-tune function. More complex applications can be controlled using additional analog inputs of flow, temperature, pressure, force, etc.

A serial RS232 or a mini USB interface allows communication with a PC where the included Numatics DigiCom software can be used to adapt the controller to the control loop. Three buttons and a 3-digit LED display on the device enable manual setpoint setting and display of feedback without the need for PLC control during start-up. Additional LEDs show the operating state and any error messages (e.g. low voltage, overvoltage, setpoint not reached) that may occur.

Auto-adapt function

Digital communication

Display

Manual adjustment

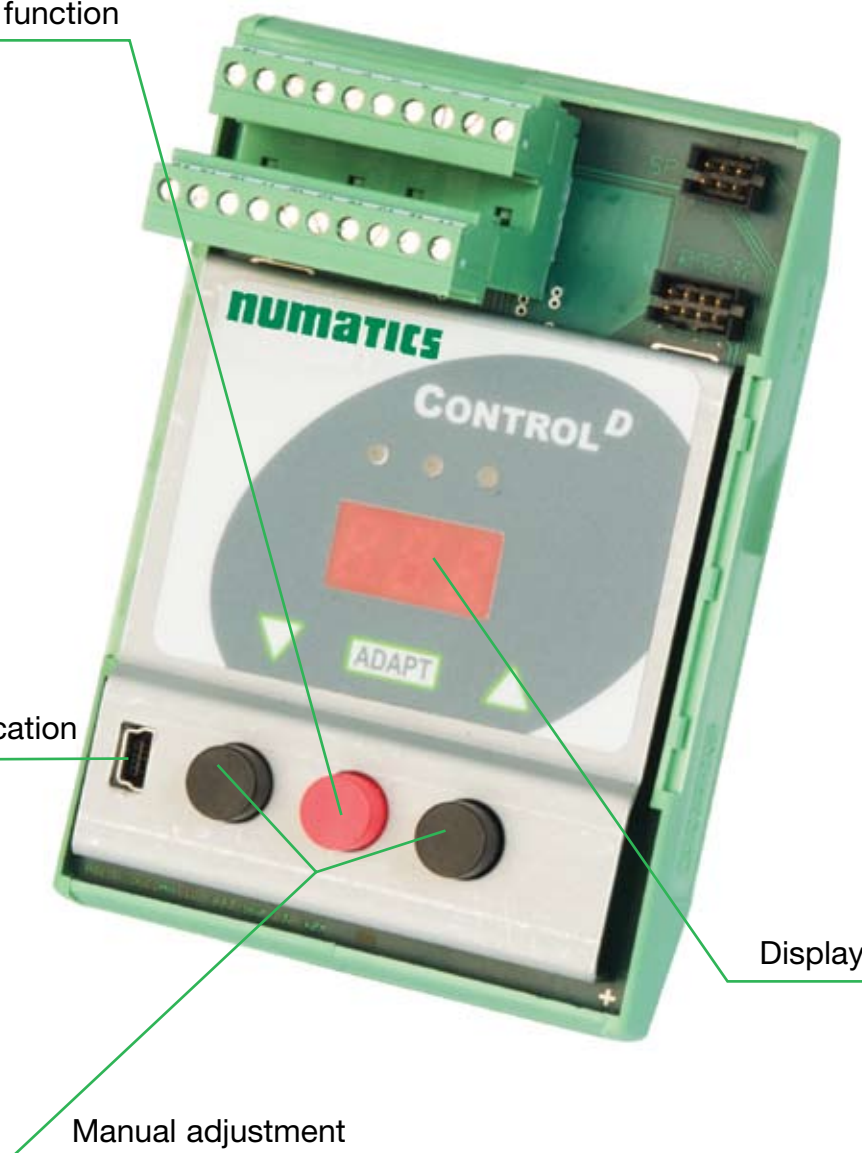



## Proportional Technology Control<sup>D</sup>

**NUMATICS**<sup>®</sup>

### Open-Loop Control



### Closed-Loop Control

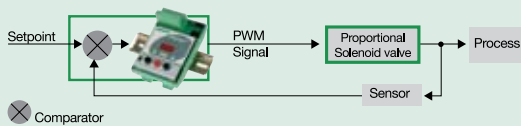

### Double-Loop (Cascaded) Control

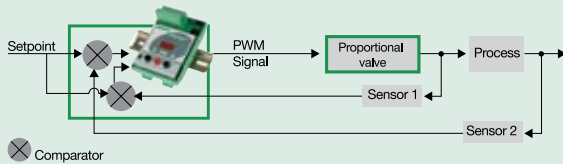

### Advantages

- Low hysteresis
- Easy change of control parameters
- Digital control
- Integrated Display
- AUTO-ADAPT button for determining max. coil current
- PC communication
- Configurable analog feedback output
- Switching output
- Scope function using DigiCom software
- USB interface
- Suitable for use with POSIFLOW, PRE-CIFLOW and SENTRONIC
- Direct input for open-loop control (no measuring device required)
- Easy to duplicate control parameters

### Specifications

Nominal voltage: 24/12 V DC +/- 10%  
 Max. current: 2A  
 Command signal: 0 - 10 V, 0 - 20 mA, 4 - 20 mA  
 Current adjustment: 0 - 2A  
 Pressure control: 0 - 100%  
 Process control: 0 - 100%  
 Ramp: ON/OFF, adjustable between 0.1 and 20 seconds  
 Frequency: 20 - 2000 Hz, adjustable  
 Electrical connection: Pluggable terminal block  
 Degree of protection: IP 20  
 Serial interface: Mini USB or RS 232 (option)

### DigiCom Software



By connecting the CONTROL<sup>D</sup> to a PC with a USB interface, the Numatics DigiCom software that comes with the product can be used to optimally adjust the valve's control parameters to a specific application.

- The scope function allows you to log and read the system's transient response in real time
- Control parameters can be adjusted to an application without removing the controller from service
- Saved control parameters can be loaded at any time

The Numatics DigiCom software offers the following features:

- Real time display of: command signal, outlet pressure, internal control parameters (e.g. P, I or D), pressure switch signal, etc.
- Parameter setting: command signal, zero offset, span, limitation of percentage of output current, ramp function, etc.
- Custom adjustment to an application
- Control of proportional devices such as POSIFLOW, PRECIFLOW or proportional pressure regulator valves



### Control<sup>D</sup> Control Device



#### Features

- Control device for PWM (pulse-width modulated) proportional solenoid valve control
- Designed for open-loop and dual-loop (cascade) control
- Suitable for the control of flow, pressure, temperature, force etc.
- Integrated display and LEDs
- Control parameters adjustable via software (DigiCom, USB interface)
- Auto-Adapt function/button for automatic adjustment of the CONTROL<sup>D</sup> control device to the control valve

A special feature of the CONTROL<sup>D</sup> is the Numatics DigiCom software supplied for optimum adjustment over PC. Setpoint and feedback values can be viewed at the same time. Other functions are valve diagnostics, parameter setting and maintenance.

#### General

Ambient temperature: -4°F to +122°F (-20 °C to +50°C)

#### Construction

Body: PA (polyamide)

Degree of protection: IP20

Electrical connection: Pluggable terminal block (0.08 - 1.5 mm<sup>2</sup>)

Mounting: DIN-EN 50022 rail

#### Electrical Characteristics

Supply voltage: (U<sub>N</sub>) 24 V DC ±10 %, max. ripple 10%  
or 12 V DC +15 % -5 %, max. ripple 10 %

Max. current of proportional solenoid valve: 2 A

Command signal: 0 - 10 V DC, 0 - 20 mA, 4 - 20 mA

Sensor input: 0 - 10 V DC, 0 - 20 mA, 4 - 20 mA

Feedback output: 0 - 10 V, 0 / 4 - 20 mA

Ramp: ON/OFF  
adjustable between 0.1 and 20 sec.

Adjustable switching frequency: 20 to 2000 Hz

#### Control<sup>D</sup> offers 3 control modes

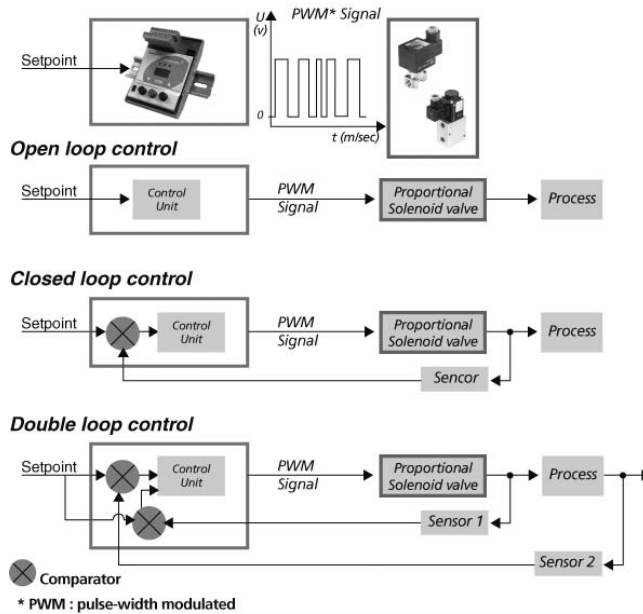

### Specifications

DESCRIPTION	CATALOG NUMBER
CONTROL <sup>D</sup> control device - 12 V DC	60300117
CONTROL <sup>D</sup> control device - 24 V DC	60300118



## Proportional Technology Control<sup>D</sup>

# NUMATICS<sup>®</sup>

### Dimensions in inches (mm), Weight in lbs (kg)

Weight: 0.33 (0.15)

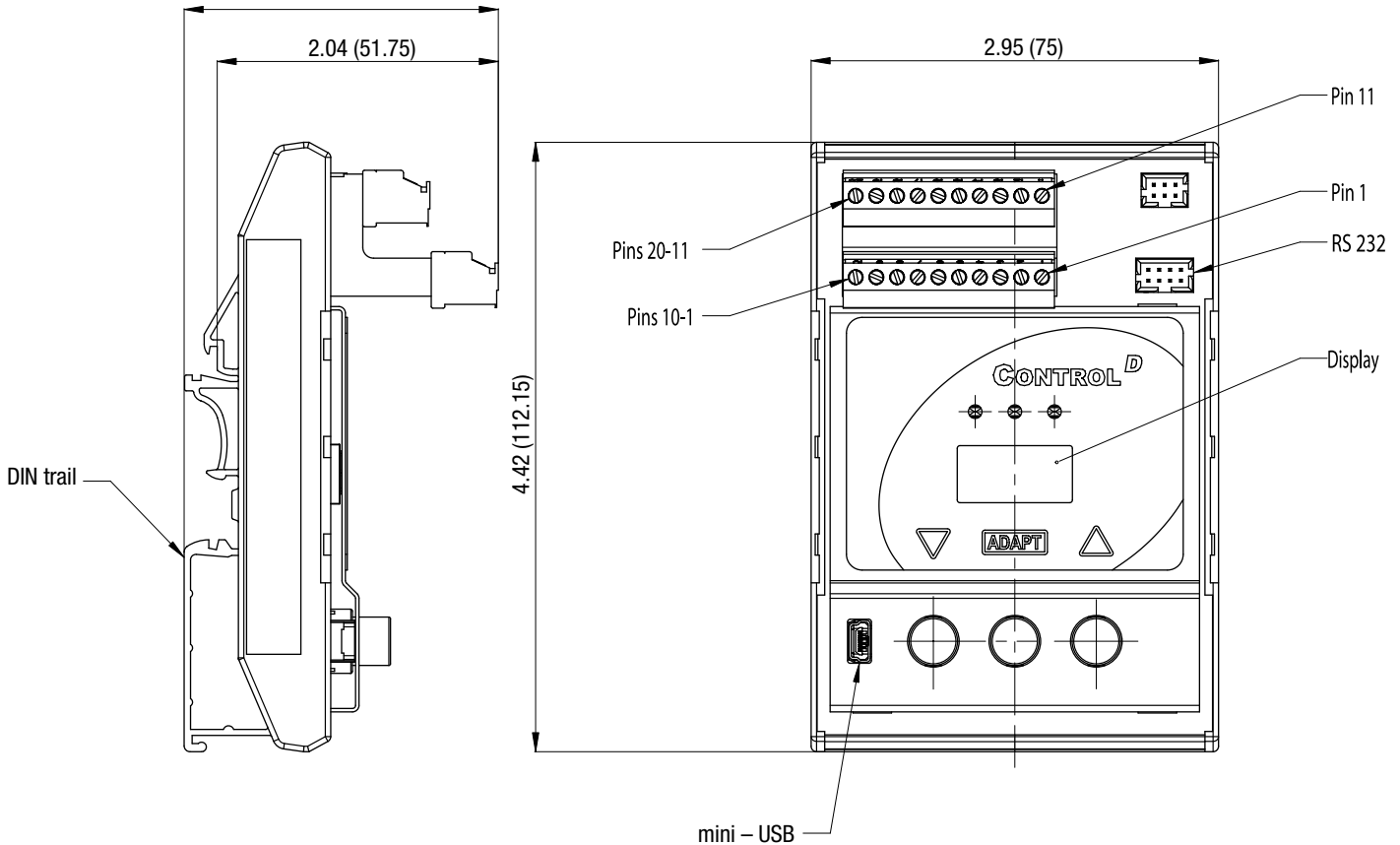

### Connector Pin Out

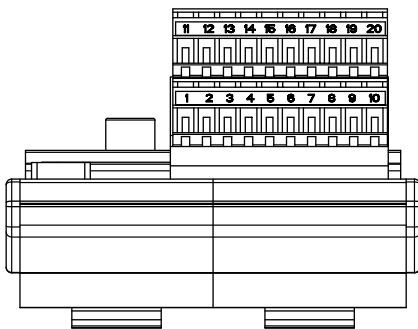

PIN	DESCRIPTION	PIN	DESCRIPTION
1	Supply +VDC	11	Command Signal
2	Supply +0VDC common	12	Command signal common
3	Earth ground	13	Digital input +VDC
4	Frequency input	14	Digital input +0VDC common
5	Sensor 1 supply +VDC	15	Valve / coil +VDC
6	Sensor 1 analog input	16	Valve / coil +0VDC common
7	Sensor 1 supply +0VDC common	17	Digital output +VDC
8	Sensor 2 supply +VDC	18	Digital output +0VDC common
9	Sensor 2 analog input	19	Analog output common
10	Sensor 2 supply +0VDC common	20	Analog output

### Accessories

DESCRIPTION PC SOFTWARE & CABEL CONNECTORS	MODEL NUMBER
Numatics DigiCom software for CONTROL <sup>D</sup> on CD-ROM (supplied with the controller)	88100893
RS 232 cable converter; 2m cable with 9-pin Sub-D (plug connector)	88100732
RS 232 cable converter; 2m cable with 9-pin Sub-D (screw connector)	833-993708





### G3 Fieldbus - Electronics Made Easy!

**Innovative Graphic Display is used for easy commissioning, visual status & diagnostics.**

#### Commissioning Capabilities

- Set network address (including IP & Subnet mask for Ethernet)
- Set baud rate
- Set auto or manual I/O sizes
- Set fault/idle output states
- Set brightness
- Set factory defaults

#### Visual Diagnostics

- Shorted and open load detection
- Shorted sensor/cable detection
- Low & missing power detection
- Missing module detection
- Self-test activation
- Log of network errors
- Distribution errors



Graphic Display for configuration & diagnostics



Auto Recovery Module

### G3 Fieldbus Communications Electronics

*Why use Numatics Fieldbus communication electronics?*  
**Modular Reality...**

- No internal wiring simplifies assembly
- SPEEDCON M12 connector technology allows for fast and efficient 1/2 turn I/O connector attachment.
- Power connector allows output power to be removed while inputs and communication are left active.
- IP65 & IP67 protection
- Up to 1200 Input / 1200 Output capability with one communication node! (Present physical I/O combinations allows 1200 I / 544 O)
- 32 valve solenoids per manifold up to 17 manifolds per communication node!
- One node supports 16 I/O modules – Analog I/O, Digital I/O (NPN & PNP) and Specialty
- Innovative clip design allows easy module removal/replacement without dismantling manifold
- Auto Recovery Module (ARM) protects configuration information during a critical failure. Allows configuration information to be saved and reloaded to replacement module automatically.



Highly Distributable



High Current Analog Module

#### Supported Protocols

- DeviceNet™
- DeviceNet™ w/Quick Connect
- Ethernet
- PROFIBUS®-DP
- CANopen®
- PROFINET®
- DeviceNet™ w/DeviceLogix™



#### \* High current analog module



- Controls 2 proportional direct-operated high current valves
- Auxiliary power connection
- Simple connection for external sensor (one for each output)

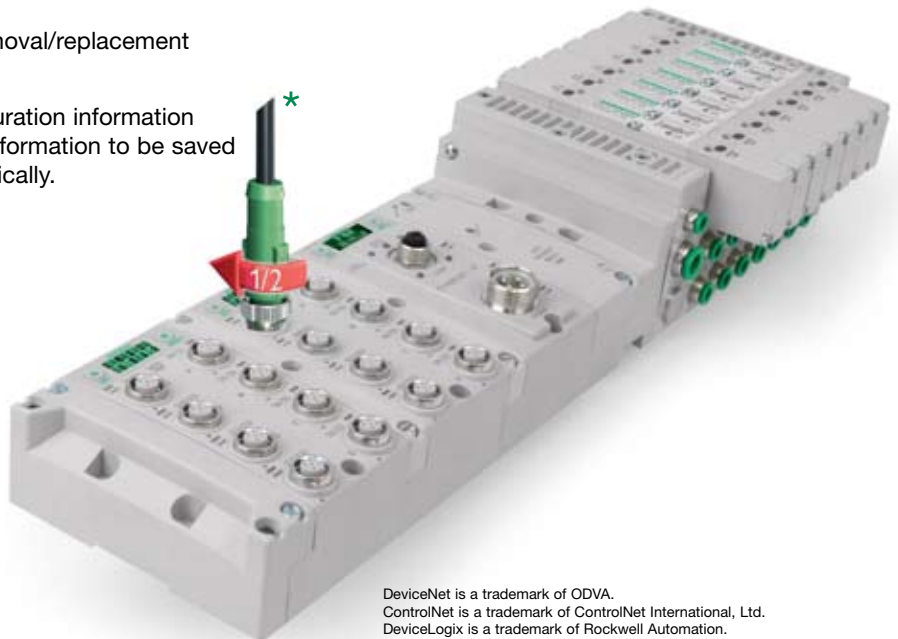

DeviceNet is a trademark of ODVA.  
ControlNet is a trademark of ControlNet International, Ltd.  
DeviceLogix is a trademark of Rockwell Automation.  
AS-interface is a registered trademark of AS-International.  
PROFIBUS and PROFINET are registered trademarks of Profibus International.  
FOUNDATION Fieldbus is a trademark of Fieldbus Foundation.  
InterBus-S is a trademark of Phoenix Contact.

**Notes**

---



# NUMATICS

*World Class Supplier  
of Pneumatic Components*

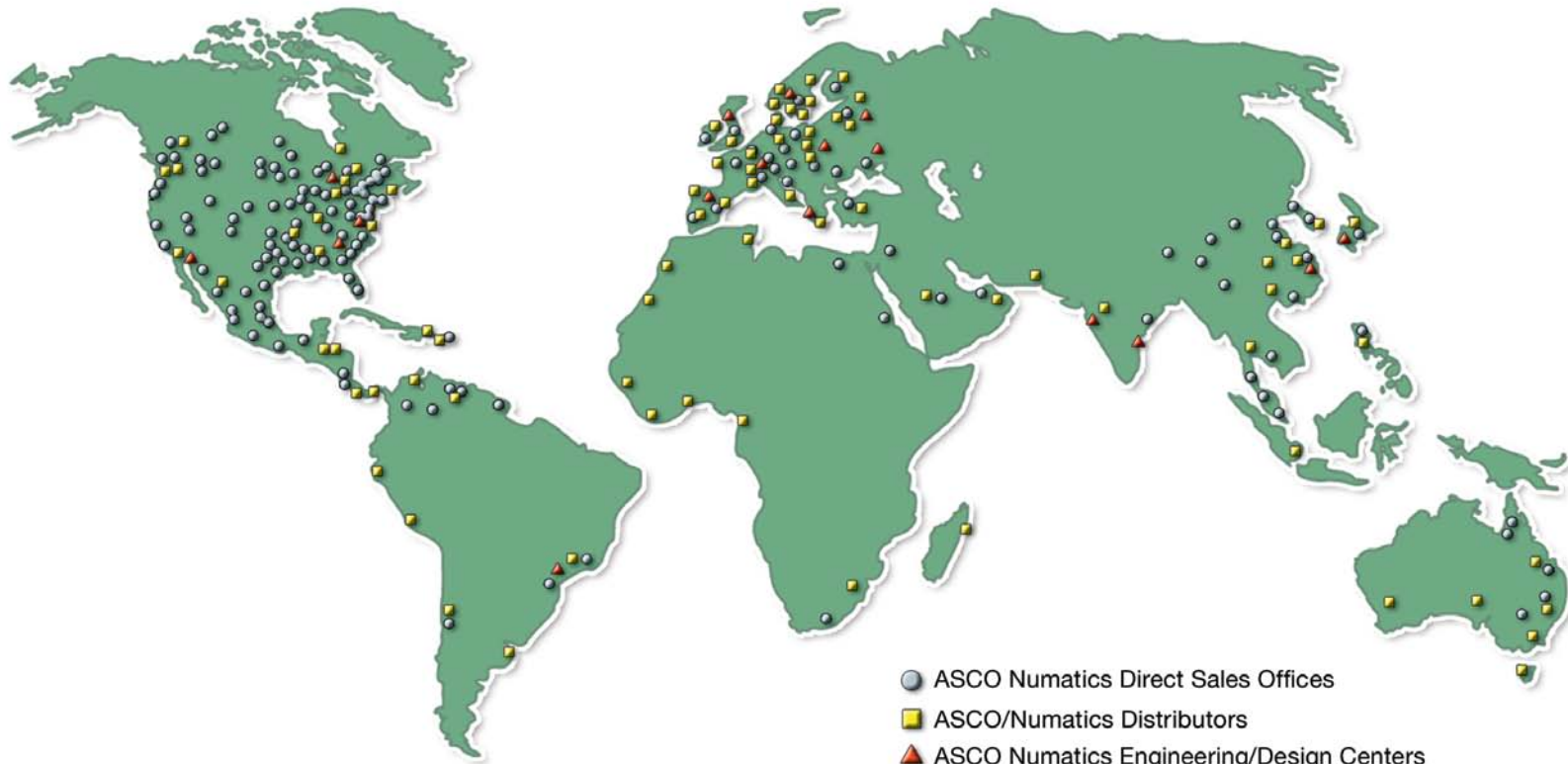

- ASCO Numatics Direct Sales Offices
- ASCO/Numatics Distributors
- ▲ ASCO Numatics Engineering/Design Centers

## WORLD HEADQUARTERS

### USA

#### Numatics, Incorporated

46280 Dylan Drive  
Novi, Michigan 48377

P: 1-888-Numatics  
1-888-686-2842

### Canada

#### Numatics, Ltd

P: 519-452-1777

### Mexico

#### Numatics de Mexico S.A. de C.V.

P: 52-222-284-6176

For a comprehensive listing of all Numatics production and distribution facilities worldwide, visit:

**[www.numatics.com](http://www.numatics.com)**