



Handling technology

Module for
Universal Robots

THE KNOW-HOW FACTORY



THE KNOW-HOW FACTORY

ZIMMER GROUP COMMITTED TO OUR CUSTOMERS

WE HAVE SUCCEEDED FOR YEARS BY OFFERING OUR CUSTOMERS INNOVATIVE AND INDIVIDUALIZED SOLUTIONS. ZIMMER HAS GROWN CONTINUOUSLY AND TODAY WE HAVE REACHED A NEW MILESTONE: THE ESTABLISHMENT OF THE KNOW-HOW FACTORY. IS THERE A SECRET TO OUR SUCCESS?

Foundation. Excellent products and services have always been the foundation of our company's growth. Zimmer is a source of ingenious solutions and important technical innovations. This is why customers with high expectations for technology frequently find their way to us. When things get tricky, Zimmer Group is in its best form.

Style. We have an interdisciplinary approach to everything we do, resulting in refined process solutions in six technology fields. This applies not just to development but to production. Zimmer Group serves all industries and stands ready to resolve even the most unique and highly individualized problems. Worldwide.

Motivation. Customer orientation is perhaps the most important factor of our success. We are a service provider in the complete sense of the word. With Zimmer Group, our customers have a single, centralized contact for all of their needs. We approach each customer's situation with a high level of competence and a broad range of possible solutions.



HMI – HUMAN MACHINE INTERFACE

EASY TO INTEGRATE – EASY TO USE

SIMPLE OPERATION

Operating Industrie 4.0 components from Zimmer Group is just as easy and flexible as installing them. What originally applied primarily for industrial control systems is now also available for robots.

In doing so, operation is integrated completely into the robot control system. As a result, the Zimmer Group components can now be configured manually using the robot control panel directly and integrated into the robot program sequence. An external PLC control system is not required to do this. The Universal Robots specialists oriented themselves toward the already familiar Zimmer HMI to create a uniform, intuitive user interface for the user.

The user can control the complete IO-Link gripper portfolio from the Zimmer Group using this tailor-made complete system and can use pneumatic, electrical, servo-electric as well as digital Zimmer Group components with innovative robots from Universal Robots.

BECAUSE SIMPLE IS SIMPLY BETTER

This integration makes it possible for the user to enable maximum levels of flexibility and straightforward adaptation, storage and restoring device parameters during the creation of new application-specific profiles.

Furthermore, the Zimmer HMI supports condition monitoring or predictive maintenance of the components. This makes it possible for any user to implement and commission Zimmer Group components within a few minutes. This simplifies the interaction of robots and handling components considerably.

CONFIGURATION

► Graphic component selection

Easiest assignment of a Zimmer gripper to the robot

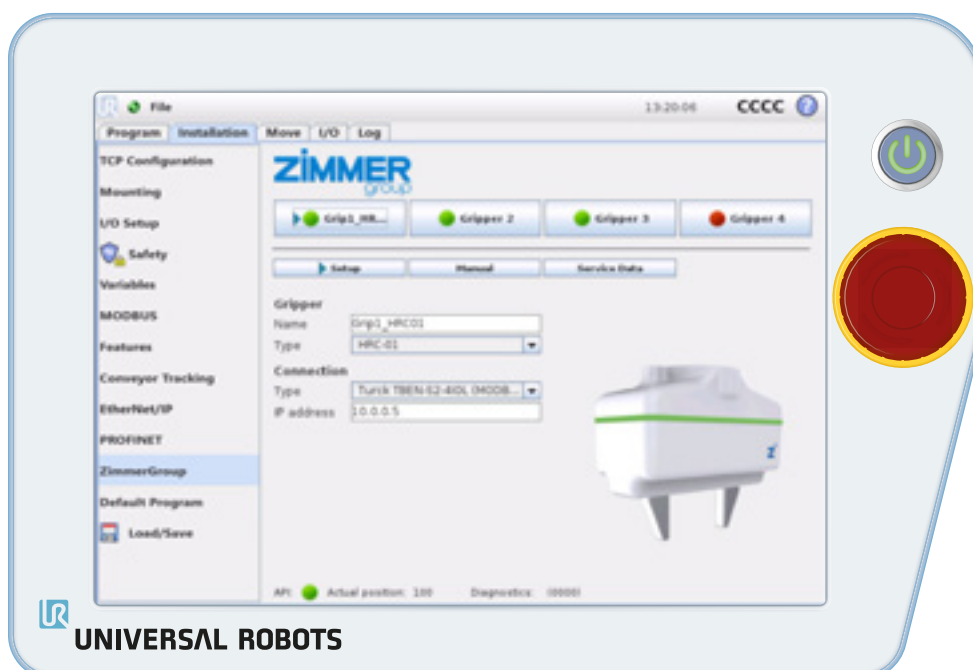

MANUAL OPERATION

► Generating the gripper process parameters

such as gripping forces, gripper positions, gripping speed, etc.

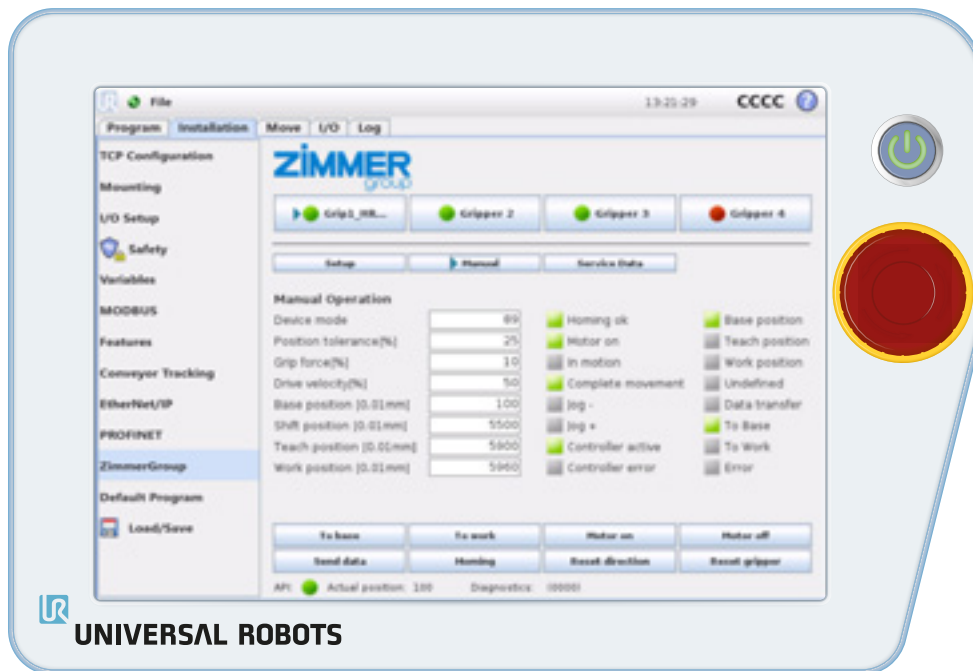

AUTOMATIC MODE ROBOT

► Use of function blocks

such as Open gripper / Close gripper, etc. for easy operation

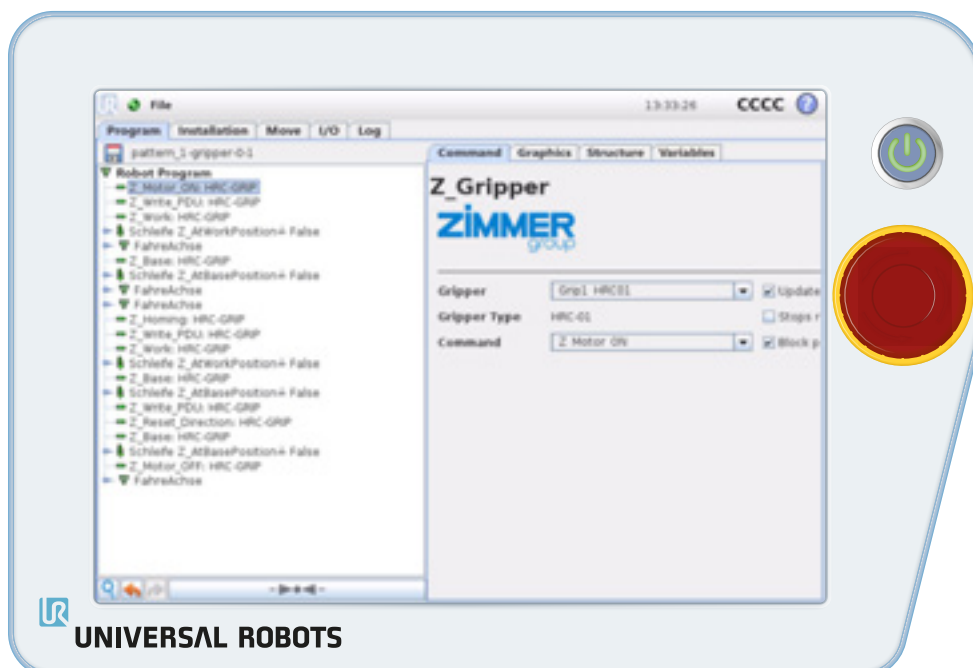

HUMAN – ROBOT

DIFFERENT FORMS OF INTERACTION

CONVENTIONAL COMPONENTS

► Automation cell



- Separated workspaces
- Workpiece handling in a secure area
- All gripping systems can be used
- Decoupled work
- No contact necessary
- Maximum speed

► Coexistence

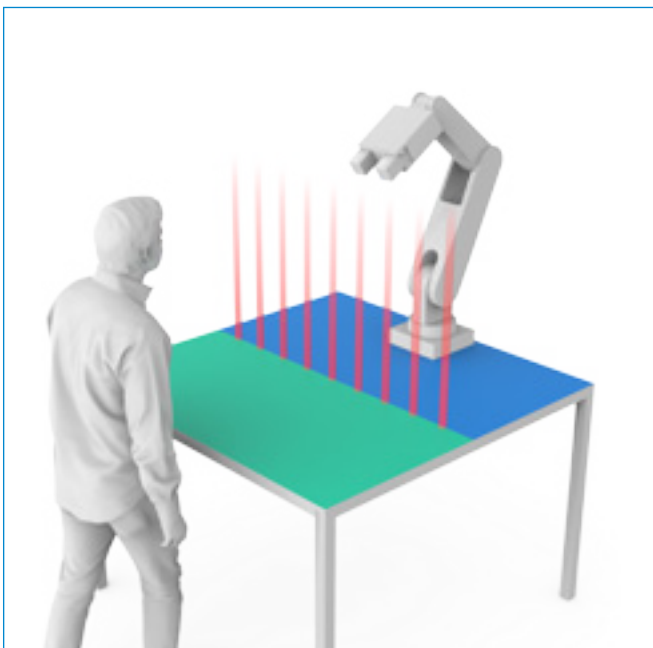

- Detection of presence
- Workpiece handling in a secure area
- All gripping systems can be used
- Separated workspaces
- Decoupled work
- No contact necessary
- Reduced speed

HRC COMPONENTS

► Cooperation

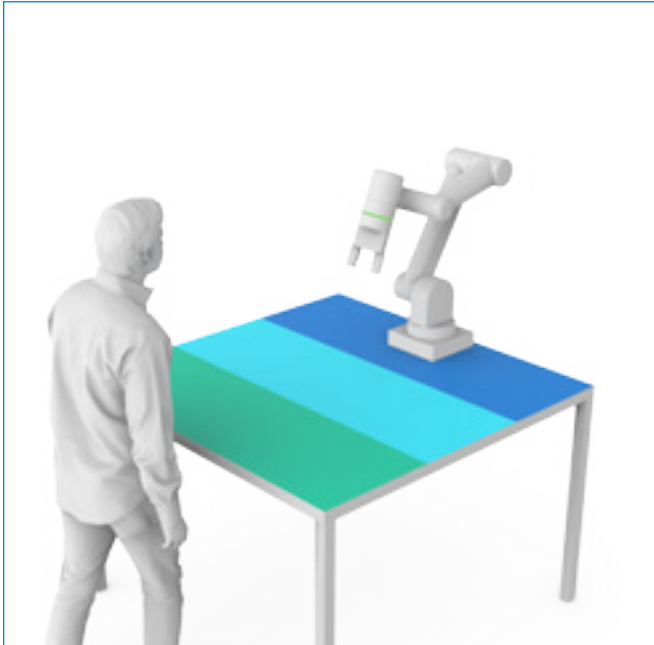

- Zones of action
- Workpiece handling in a secure area
- Gripper with special HRC geometry
- Secure holding of the workpiece even if the power supply fails
- Shared workspaces
- Coupled work
- No contact necessary
- Reduced speed

► Collaboration

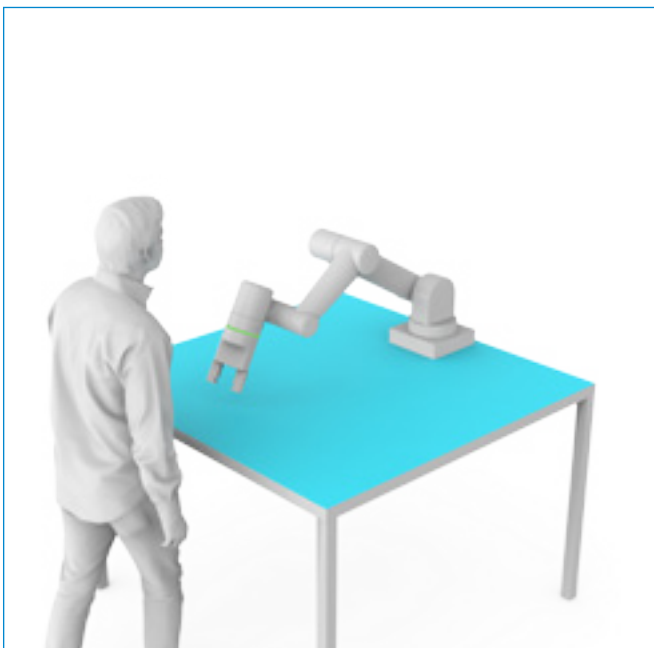

- Shared workspaces
- Workpiece handling in an unsecure area
- Gripper with special HRC geometry and reliable gripping force limiter
- Gripping force limited to a max. of 140 N as per ISO/TS 15066
- Secure holding of the workpiece even if the power supply fails
- Coupled work
- Contact is necessary
- Reduced speed

HMI CONFIGURATION PACKAGE

EASY-TO-USE PACKAGE

▶ MAXIMUM PERFORMANCE INCLUDED

The combination of Zimmer Group components, the Zimmer Easy-to-Use Package and UR robots ensure the easiest integration as well as intuitive operation. Maximum performance included!



FOR MORE INFORMATION ABOUT THE EASY-TO-USE PACKAGE VISIT US AT:
www.zimmer-group.com



Software

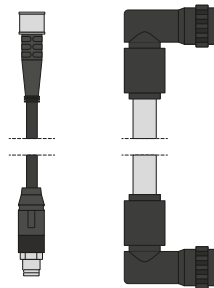

Cables and accessories



IO-Link master

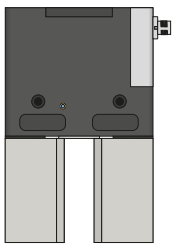

Zimmer Group gripper *

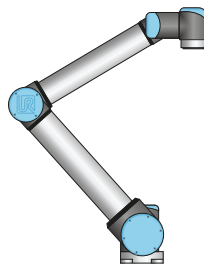

UR robot *
(industrial / collaborative)

FOR MORE INFORMATION ABOUT UNIVERSAL ROBOTS VISIT US AT:

www.universal-robots.com

* Available separately

► **Zimmer Easy-to-Use Package for UR¹**

Part number	Article	Description
ZUB068713	IO-Link master	IO-Link master
	Connecting cable, M8 4-pin 5 m	Cable for supplying power to the master
	Cable for connecting the Modbus to the master	Communications cable between the robot and master RJ 45
	UR-Caps (software)	HMI for UR robots

► **Required accessories according to gripper series**

Part number	Article	Description	GPP5000IL ^{3,4}	GEP2000IL, GEH6000IL, GEP5000IL, GED5000IL ³	HRC-01 ³	HRC-03 ³	HRC-04 ³	HRC-05 ³
KAG500	Connecting cable M8 3-pin 5 m	STO cable (Safe Torque Off)			•			
KAG500IL	Connecting cable M12 5-pin 5m	Connection between IO-Link master and gripper	•	•	•	•	•	•
B12-Y-5IL	Y adapter	Splitting between data and power supply		•	•	•		
KAG500-02	Connecting cable (Y to Power)	Connecting cable to power adapter		•	•	•		
CELE01442	Power adapter ²	Power adapter for power supply (24V/10A)		•	•	•		

► **Optional accessories**

Part number	Article	Description	GPP5000IL	GEP2000IL, GEH6000IL, GEP5000IL, GED5000IL	HRC-01	HRC-03	HRC-04	HRC-05
ZUB000009	UR3 energy chain	Energy chain for robot of type UR3	•	•	•	•	•	•
ZUB000010	UR5 energy chain	Energy chain for robot of type UR5	•	•	•	•	•	•
ZUB000011	UR10 energy chain	Energy chain for robot of type UR10	•	•	•	•	•	•

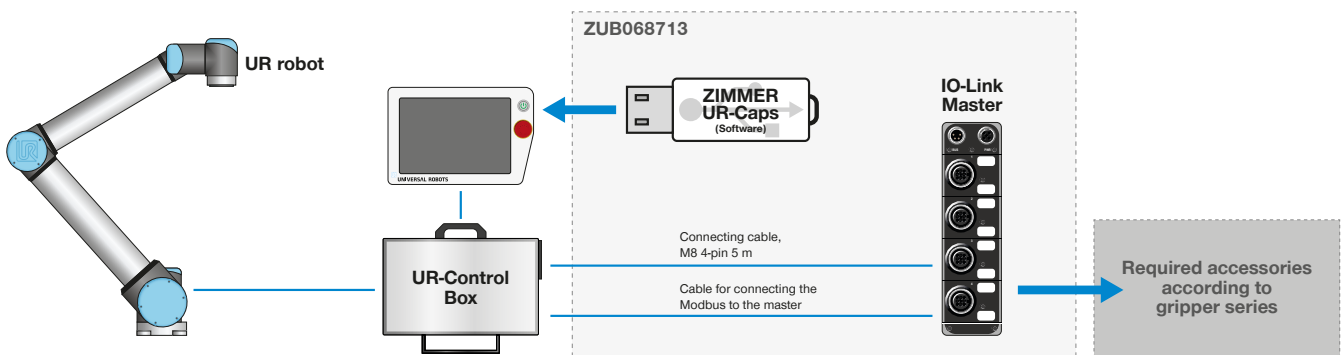

¹ The Easy-to-Use Package is required once per robot and enables the operation of up to 4 different IO-Link grippers.

² The power adapter provides 10 A (15 A peak). Please observe the current draw of the respective gripper series.

³ These additions are needed each for one gripper. The energy chains are optional here.

⁴ The following hose outer diameter is recommended: GPP5006: 4 mm / GPP5008: 4 mm / GPP5010: 6 mm

HUMAN-ROBOT COLLABORATION

EASY TO INTEGRATE – EASY TO HANDLE

WHAT IS HUMAN-ROBOT COLLABORATION?

The demographic development in industrial countries will lead to comprehensive changes in the working world in coming years. In the future, people will collaborate more and more with robots or have their work supported by robots. For this vision of a collaborative working world to become reality, however, we need more than just a new kind of safe robot with overload limiters, comprehensive sensors and fast-reacting control systems. The tool at the end of the robot also has to satisfy comprehensive requirements with respect to occupational safety, work environment, use of equipment, approval and acceptance, etc. The directives concerning specification

of the safety-related requirements for robots, ISO 10218 and their technical specification ISO/TS 15066, currently describe the forms of collaboration. Even though these regulations are currently valid, they are being revisited by both DIN and CEN in the context of collaborative use of robots. That's why a product developed for this purpose should go beyond the current requirements. The HRC gripper series from Zimmer Group have been designed in accordance with recommendations from BG/DGUV (German occupational insurance association / German Social Accident Insurance).

HRC FROM THE EXPERTS

As a pioneer and one of the world's leading manufacturers of HRC grippers, Zimmer Group develops components specifically for this work environment to reduce the physical load on the

employees, mitigate against monotonous work steps, prevent accidents and increase the efficiency of workflows through human-robot collaboration.

EASY TO INTEGRATE

Naturally, however, not only the world's best HRC grippers are available for Universal Robots, but also a comprehensive system module specially matched to your model. This provides a broad selection of grippers and handling components with corresponding accessories, so that you don't have to worry about compatibility and integration. Of course, this system

module also includes HRC and Industrie 4.0 components that are compatible with your robot. These open up numerous advantages for you: easy to install, easy to configure, easy to operate, advanced diagnostics and preventive maintenance as well as the ability to make replacements while operation is in progress.

EASY TO HANDLE

The components are operated either using the central control system or, as is the case for most components, using the integrated control panel or via an app. The app offers users the maximum level of flexibility when creating, storing and restoring device parameters and also provides assistance during diagnostics/preventive maintenance. Furthermore,

the HRC grippers and conventional grippers offer the user practical, pre-programmed movement profiles, which can be adjusted to the individual requirements of the gripping application with just a few mouse clicks. This ensures that complete implementation and commissioning are possible for any user within just a few minutes.









HRC COMPONENTS

THE SERIES AT A GLANCE



UR3



2-JAW PARALLEL GRIPPERS			2-JAW ANGULAR GRIPPERS		
COLLABORATIVE			COLLABORATIVE		
ELECTRIC			PNEUMATICALLY INTELLIGENT		
HRC-03-072844  	Stroke per jaw: Gripping force (max.): Weight: IP class: Maintenance-free (max.):	10 mm < 140 N 0.68 kg 40 10 million cycles	HRC-05-072836  	Stroke per jaw: Gripping force (max.): Weight: IP class: Maintenance-free (max.):	37.5° < 140 N 0.82 kg 40 10 million cycles
Mechanical self-locking mechanism in the event of a power drop			Gripping force safety device in case of pressure failure via integrated spring		
PNEUMATICALLY INTELLIGENT					
HRC-04-072810  	Stroke per jaw: Gripping force (max.): Weight: IP class: Maintenance-free (max.):	6 mm < 140 N 0.76 kg 40 10 million cycles			
Gripping force safety device in case of pressure failure via integrated spring					

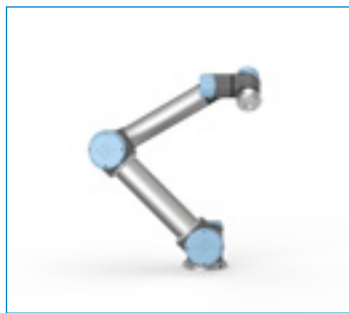

UR5

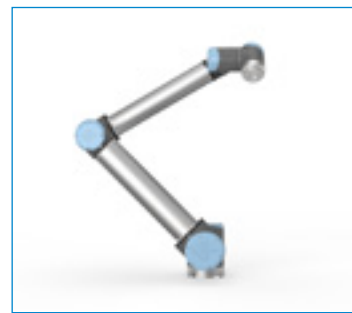



UR10





2-JAW PARALLEL GRIPPERS

COOPERATIVE ELECTRIC | **COLLABORATIVE ELECTRIC**

COOPERATIVE ELECTRIC



HRC-01-072802 *
 
 Stroke per jaw: 60 mm
 Gripping force: 950 N
 Weight: 1.6 kg
 IP class: 40
 Maintenance-free (max.): 5 million cycles

STO safety functions + mechanical self-locking mechanism in the event of a power drop



HRC-01-072824 **
 
 Stroke per jaw: 60 mm
 Gripping force: 950 N
 Weight: 1.6 kg
 IP class: 40
 Maintenance-free (max.): 5 million cycles

STO safety functions + mechanical self-locking mechanism in the event of a power drop



COLLABORATIVE ELECTRIC

HRC-01-072819 *
 
 Stroke per jaw: 60 mm
 Gripping force (max.): < 140 N
 Weight: 1.8 kg
 IP class: 40
 Maintenance-free (max.): 5 million cycles

STO safety functions + mechanical self-locking mechanism in the event of a power drop + safety gripper jaws prevent 140 N from being exceeded



HRC-01-072830 **
 
 Stroke per jaw: 60 mm
 Gripping force (max.): < 140 N
 Weight: 1.8 kg
 IP class: 40
 Maintenance-free (max.): 5 million cycles

STO safety functions + mechanical self-locking mechanism in the event of a power drop + safety gripper jaws prevent 140 N from being exceeded

HRC-03-072844
 
 Stroke per jaw: 10 mm
 Gripping force (max.): < 140 N
 Weight: 0.68 kg
 IP class: 40
 Maintenance-free (max.): 10 million cycles

Mechanical self-locking mechanism in the event of a power drop

PNEUMATICALLY INTELLIGENT



HRC-04-072810
 
 Stroke per jaw: 6 mm
 Gripping force (max.): < 140 N
 Weight: 0.76 kg
 IP class: 40
 Maintenance-free (max.): 10 million cycles

Gripping force safety device in case of pressure failure via integrated spring

2-JAW ANGULAR GRIPPERS

COLLABORATIVE

PNEUMATICALLY INTELLIGENT

HRC-05-072836
 
 Stroke per jaw: 37.5°
 Gripping force (max.): < 140 N
 Weight: 0.82 kg
 IP class: 40
 Maintenance-free (max.): 10 million cycles

Gripping force safety device in case of pressure failure via integrated spring

* Suitable for UR5
 ** Suitable for UR10

CONVENTIONAL COMPONENTS

CONNECTION VIA MCS

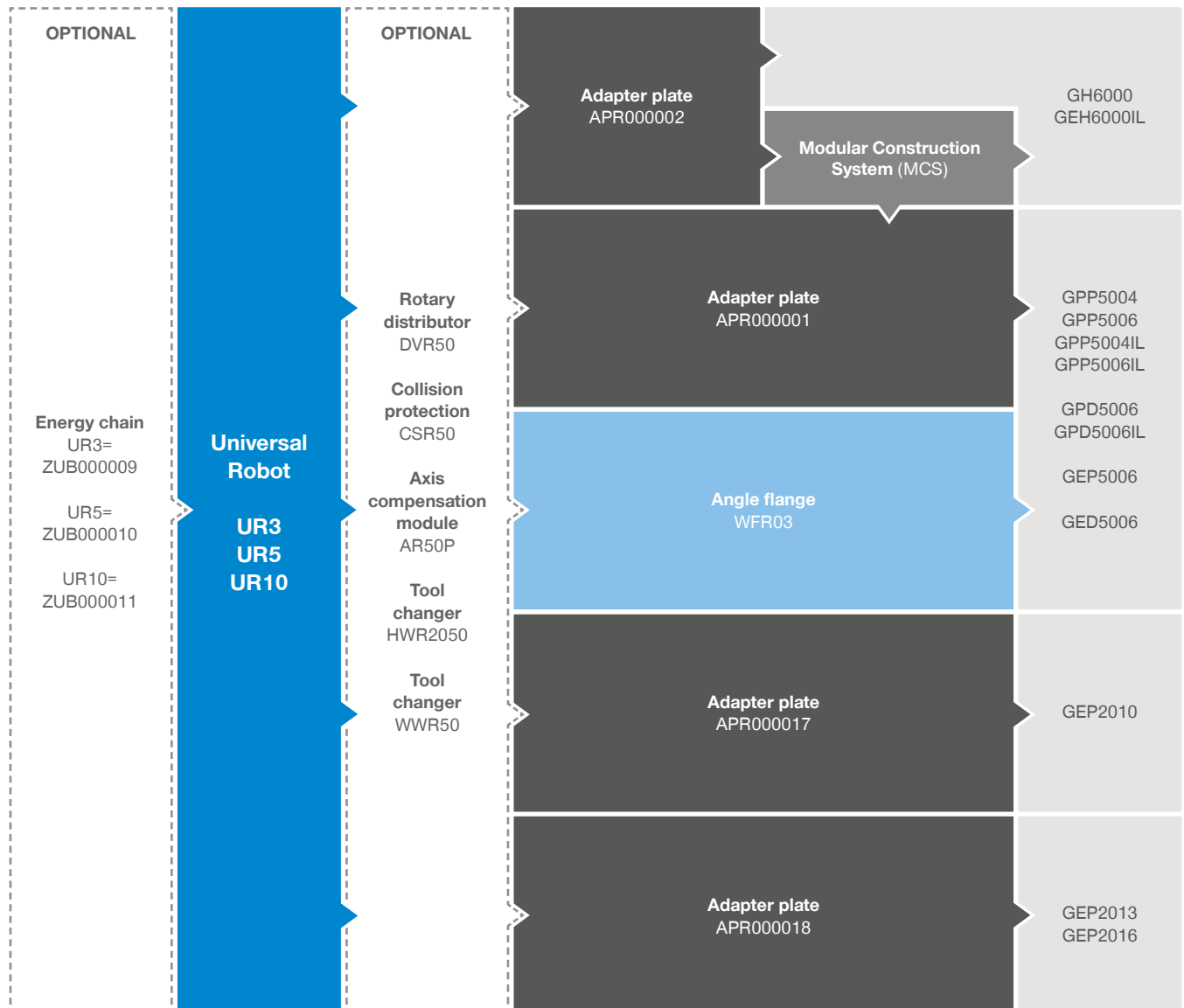

UR3



UR5

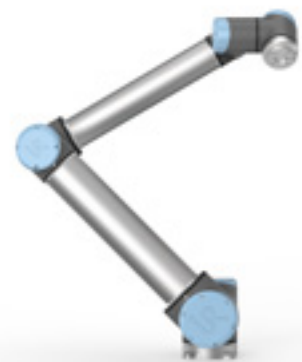

UR10

CONVENTIONAL COMPONENTS

THE SERIES AT A GLANCE

2-JAW PARALLEL GRIPPERS

PNEUMATIC		ELECTRIC	
GPP1000 	Number of installation sizes: 1 Stroke per jaw: 4 mm - 16 mm Gripping force: 100 N Weight: 0.16 kg - 0.20 kg IP class: 30 Maintenance-free (max.): 2 million cycles	GEP2000 IO-Link 	Number of installation sizes: 3 Stroke per jaw: 10 mm - 16 mm Gripping force: 50 N - 500 N Weight: 0.31 kg - 0.9 kg IP class: 40 Maintenance-free (max.): 10 million cycles
GPP5000 	Number of installation sizes: 11 Stroke per jaw: 2 mm - 45 mm Gripping force: 140 N - 26950 N Weight: 0.08 kg - 50 kg IP class: 64/67 Maintenance-free (max.): 30 million cycles	GEP5000 IO-Link 	Number of installation sizes: 3 Stroke per jaw: 6 mm - 10 mm Gripping force: 540 N - 1520 N Weight: 0.79 kg - 1.66 kg IP class: 64 Maintenance-free (max.): 30 million cycles

PNEUMATICALLY INTELLIGENT

GPP5000IL IO-Link 	Number of installation sizes: 3 Stroke per jaw: 3 mm - 10 mm Gripping force: 330 N - 2890 N Weight: 0.45 kg - 1.45 kg IP class: 64 Maintenance-free (max.): 30 million cycles
--	--

2-JAW PARALLEL GRIPPERS WITH LONG STROKE

PNEUMATIC		ELECTRIC	
GH6000 	Number of installation sizes: 5 Stroke per jaw: 20 mm - 200 mm Gripping force: 120 N - 3400 N Weight: 0.3 kg - 22.7 kg IP class: 40 Maintenance-free (max.): 10 million cycles	GEH6000IL IO-Link 	Number of installation sizes: 2 Stroke per jaw: up to 80 mm Gripping force: 100 N - 2400 N Weight: 0.7 kg - 2.6 kg IP class: 54 Maintenance-free (max.): 5 million cycles

3-JAW CONCENTRIC GRIPPERS

PNEUMATIC		ELECTRIC	
GPD5000 	Number of installation sizes: 11 Stroke per jaw: 2 mm - 45 mm Gripping force: 310 N - 72500 N Weight: 0.14 kg - 99.9 kg IP class: 64/67 Maintenance-free (max.): 30 million cycles	GED5000 IO-Link 	Number of installation sizes: 3 Stroke per jaw: 6 mm - 10 mm Gripping force: 540 N - 1520 N Weight: 1.09 kg - 2.33 kg IP class: 64 Maintenance-free (max.): 30 million cycles

PNEUMATICALLY INTELLIGENT

GPD5000IL IO-Link 	Number of installation sizes: 3 Stroke per jaw: 3 mm - 10 mm Gripping force: 740 N - 7160 N Weight: 0.75 kg - 2.5 kg IP class: 64 Maintenance-free (max.): 30 million cycles
--	---

2-JAW ANGULAR GRIPPERS

PNEUMATIC	
GPW5000 	Number of installation sizes: 3 Stroke per jaw: +15° / -2° Gripping force: 1450 N - 14500 N Weight: 0.9 kg - 12.1 kg IP class: 64 Maintenance-free (max.): 30 million cycles

CONVENTIONAL COMPONENTS

CONNECTION VIA MCS

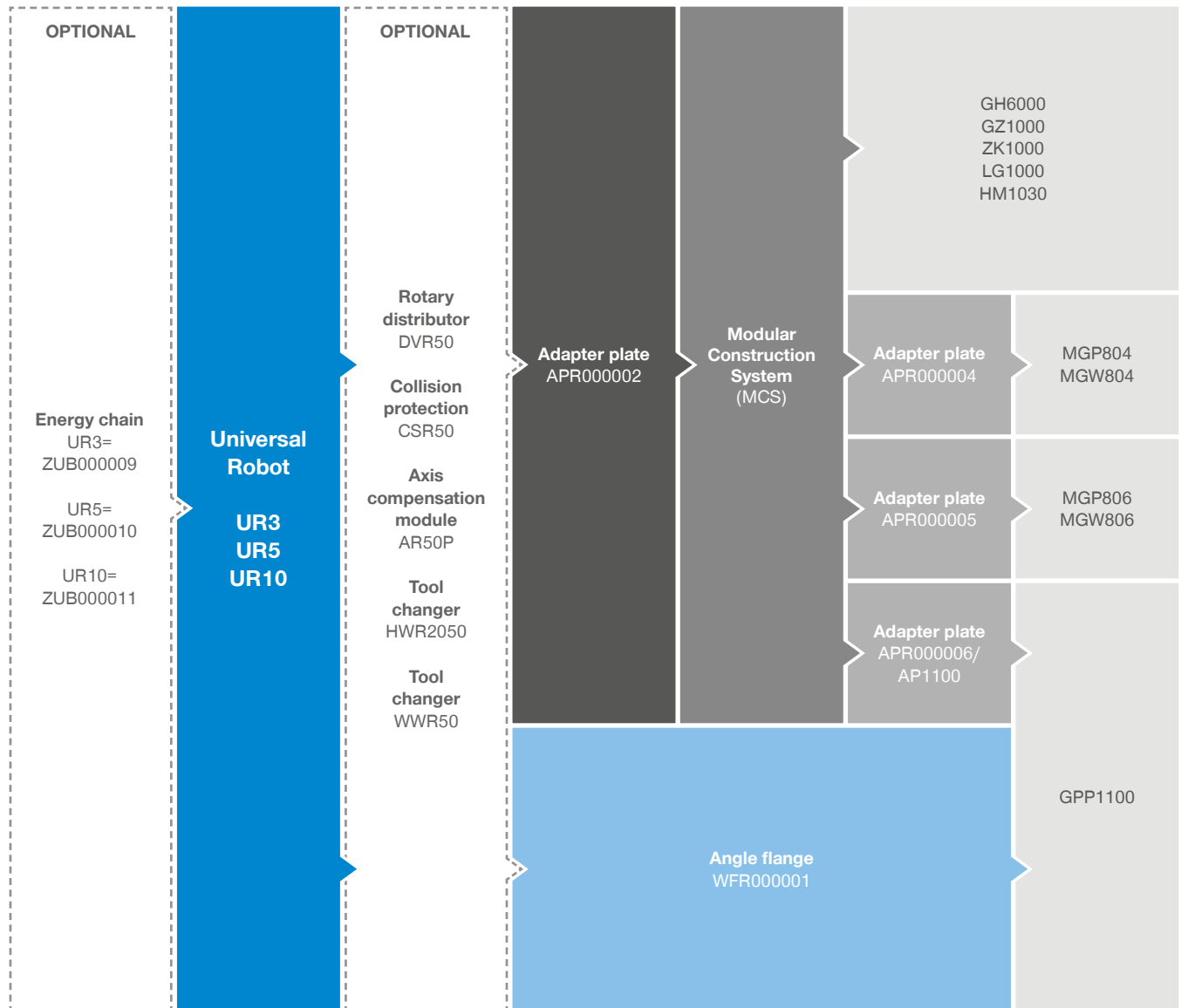

UR3



UR5



UR10

CONVENTIONAL COMPONENTS

THE SERIES AT A GLANCE

2-JAW PARALLEL GRIPPERS

PNEUMATIC

GPP1000



Number of installation sizes:	1
Stroke per jaw:	4 mm - 16 mm
Gripping force:	100 N
Weight:	0.16 kg - 0.20 kg
IP class:	30
Maintenance-free (max.):	2 million cycles

MGP800



Number of installation sizes:	8
Stroke per jaw:	1 mm - 12 mm
Gripping force:	6 N - 400 N
Weight:	0.008 kg - 0.46 kg
IP class:	40
Maintenance-free (max.):	10 million cycles

2-JAW PARALLEL GRIPPERS WITH LONG STROKE

PNEUMATIC

GH6000



Number of installation sizes:	5
Stroke per jaw:	20 mm - 200 mm
Gripping force:	120 N - 3400 N
Weight:	0.3 kg - 22.7 kg
IP class:	40
Maintenance-free (max.):	10 million cycles

2-JAW ANGULAR GRIPPERS

PNEUMATIC

GZ1000



Number of installation sizes:	3
Stroke per jaw:	8° - 11°
Gripping force:	62 N - 315 N
Weight:	0.015 kg - 0.125 kg
IP class:	30
Maintenance-free (max.):	10 million cycles

MGW800



Number of installation sizes:	8
Stroke per jaw:	37.5°
Gripping force:	5 N - 325 N
Weight:	0.01 kg - 0.45 kg
IP class:	30
Maintenance-free (max.):	10 million cycles

GRIPPERS FOR SPECIAL TASKS

INTERNAL GRIPPER

LG1000



Total stroke in Ø:	2.5 mm - 3.5 mm
Gripping diameter (min.):	8 mm - 15 mm
Gripping diameter (max.):	10.5 mm - 18.5 mm
Slip force (max.):	53 N - 58 N
Weight:	0.028 kg - 0.041 kg

MAGNETIC GRIPPER

HM1000



Adhesive force (max.):	27 N - 450 N
Weight:	0.06 kg - 2.2 kg

CUTTING TONGS

ZK1000



Stroke per jaw:	4.25° - 13°
Gripping moment in closing:	14 Nm - 400 Nm
Weight:	0.08 kg - 0.67 kg

MCS - MODULAR CONSTRUCTION SYSTEM

The modular construction system (MCS) can be used to create a workpiece-specific solution without increased engineering efforts. This is made possible by the harmonized individual components.

The product portfolio includes profiles, compensation modules, suction cup mounts as well as gripper fingers that guarantee a secure grip on the workpiece during motion. For a complete overview of all the MCS components, refer to our "Handling technology 3" catalog or visit us online at www.zimmer-group.com.

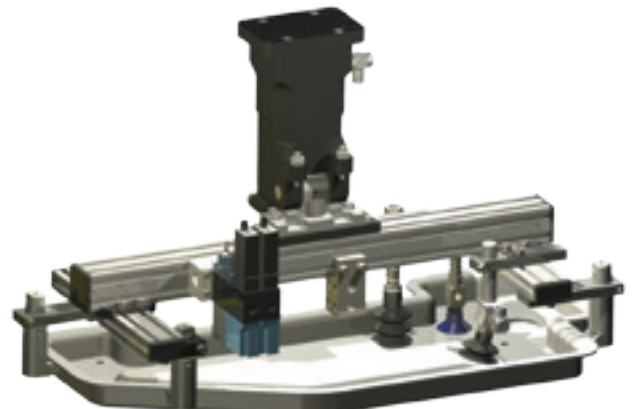

MODULAR CONSTRUCTION SYSTEM (MCS) CONNECTION EXAMPLES

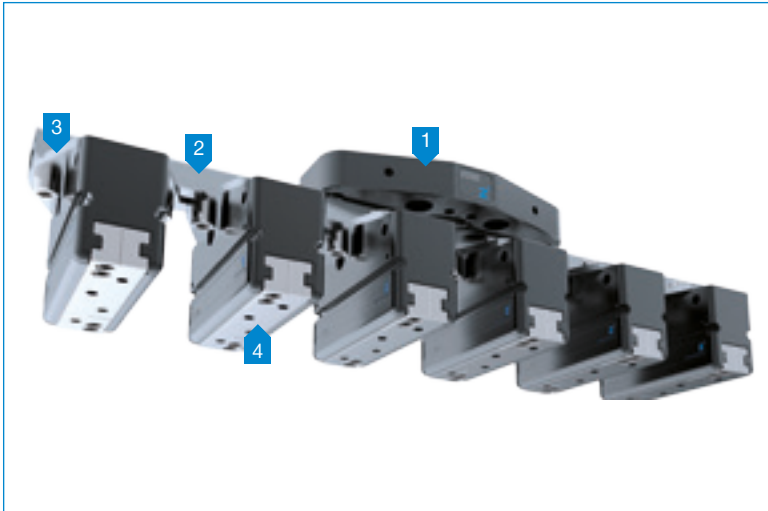

* See the Handling technology 3 catalog

CONNECTION EXAMPLE GPP1000 SERIES

UR ROBOTS UR3 / UR5 / UR10

1 Adapter plate APR000002

2 MCS Profile*

3 Adapter plate APR000006

4 Series GPP1000

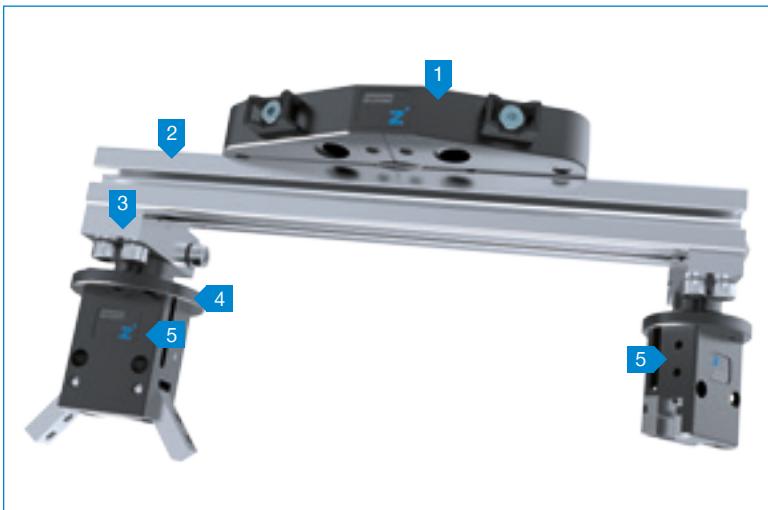

* See the Handling technology 3 catalog

CONNECTION EXAMPLE MGP800 and MGW800 SERIES

UR ROBOTS UR3 / UR5 / UR10

1 Adapter plate APR000002

2 MCS Profile*

3 MCS Clamp SO-23120022*

4 Adapter plate APR000004/APR000005

5 Series MGP800 and MGW800

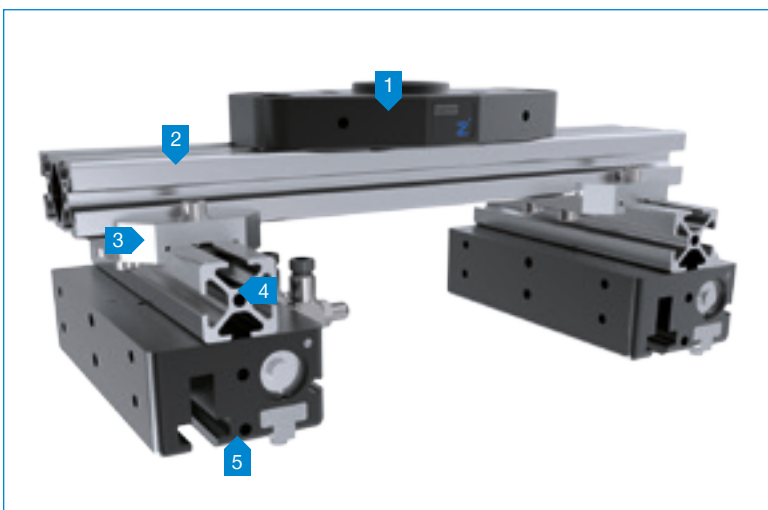

* See the Handling technology 3 catalog

CONNECTION EXAMPLE GEH6000IL/GH6000 SERIES

UR ROBOTS UR3 / UR5 / UR10

1 Adapter plate APR000002

2 MCS Profile*

3 MCS Cross clamp*

4 MCS Profile*

5 Series GEH6000IL/GH6000

USAGE NOTE

GENERAL INFORMATION

The contents of this catalog are not legally binding and are intended solely for informational purposes. Any final agreement will be in the form of a written order confirmation from Zimmer GmbH, which occurs only subject to the respective current General Terms and Conditions of Sale and Delivery of Zimmer GmbH. These can be found online at www.zimmer-group.com.

All of the products listed in this catalog are designed for their intended use, e.g. machines for automation. The recognized technical regulations for safety and professional work must be followed for use and installation. Furthermore, the respective laws, guidelines from TÜV, guidelines from the respective trade association and VDE stipulations shall apply.

The technical data listed in this catalog must be observed by the user. The user must not exceed or fail to meet the specified data. If that information is missing, it cannot be assumed that there are no upper or lower limits or no limitations for specific use cases. Consultation is always required for unusual use cases.

Disposal is not included in the price, which would have to be taken into account accordingly in the event of return to or disposal by Zimmer GmbH.

TECHNICAL DATA AND FIGURES

The technical data and figures have been compiled with great care and to the best of our knowledge. We cannot guarantee that the information is up to date, correct or complete.

The specifications and information—such as figures, drawings, descriptions, dimensions, weights, materials, technical and other performance data and the described products and services—contained in general product descriptions, Zimmer GmbH catalogs, brochures and price lists in any form are subject to change and may be modified or updated at any time without prior notification. They are binding only to the extent expressly specified in a contract or order confirmation. Slight deviations from such descriptive product information shall be considered approved and shall not affect fulfillment of agreements insofar as they are reasonable for the customer.

LIABILITY

Products from Zimmer Group are subject to the German Product Liability Act. This catalog does not contain any guarantees, assurances of quality or procurement agreements for the products it depicts, neither expressly nor implied, including for the availability of products. Advertising statements relating to quality features, properties or applications for the products are not legally binding.

To the extent permitted by law, Zimmer GmbH is exempt from any liability for direct or indirect damage, subsequent damage and requests of any kind or on any legal basis resulting from the use of information contained in this catalog.

TRADEMARK, COPYRIGHT AND REPRODUCTION

The depiction of commercial property rights in this catalog—such as brands, logos, registered trademarks or patents—does not include the granting of licenses or use rights. Their use is not permitted without the express written agreement of Zimmer GmbH. All contents of this catalog are the intellectual property of Zimmer GmbH. For the purposes of copyright, any unlawful use of intellectual property, including excerpts, is prohibited. Reprinting, copying or translating (including in the form of excerpts) are permitted only with the prior written consent of Zimmer GmbH.

STANDARDS

Zimmer Group has a quality management system certified in accordance with ISO 9001:2008. Zimmer Group has an environmental management system certified in accordance with ISO 14001:2017.

The contents and data correspond to the status as of printing, Edition 06/2018.

This catalog was created with great care and all information has been checked for accuracy. However, we assume no liability for incorrect or incomplete information.

Zimmer Group reserves the right to technical changes and improvements through constant ongoing development of products and services.

All text, images, depictions and illustrations in this catalog are the property of Zimmer Group and protected by copyright. Any duplicating, editing, changing, translating, filming, processing or saving in electronic systems is prohibited without the consent of Zimmer Group.

ZIMMER GROUP – THE KNOW-HOW FACTORY

NEW TECHNOLOGY, COMPONENTS, BUSINESS DIVISIONS AND LOCATIONS ACROSS THE GLOBE – OUR COMPANIES HAVE BECOME STRONG AND OUR RANGE OF PRODUCTS HAS GROWN MORE DIVERSE.

THE NEW **ZIMMER GROUP** UMBRELLA BRAND HELPS GIVE YOU DIRECTION AMONG THIS NEW DIVERSITY. IT COMBINES THE COMPANIES ZIMMER GMBH, ZIMMER KUNSTSTOFFTECHNIK, ZIMMER DAEMPfungSSYSTEME AS WELL AS BENZ WERKZEUGSYSTEME INTO ONE PARTNER FOR YOUR PROJECTS: THE KNOW-HOW FACTORY.

CHALLENGE US. DISCOVER THE ENTIRE WORLD OF ZIMMER GROUP! IF YOU HAVE QUESTIONS ABOUT THE NEW ZIMMER GROUP AND OUR TECHNOLOGY, WE WOULD BE HAPPY TO ANSWER THEM.

BRAZIL, ARGENTINA, BOLIVIA, CHILE, ECUADOR, GUYANA, PARAGUAY, PERU, URUGUAY, VENEZUELA:
ZIMMER GROUP SOUTH AMERICA IMP. EXP. LTDA
 Rua Wolsir A. Antonini 120 Bairro Fenavinho
 BR 95703-362 Bento Goncalves – RS
 T +55 54 2102-5400
 F +55 54 3451-5494
 info.br@zimmer-group.com
www.zimmer-group.com.br

CHINA:
ZIMMER GROUP CHINA LTD.
 Level 2-D3 Bldg 4 No. 526
 Fu-Te East 3rd Rd
 CN 200131 Pudong, Shanghai
 T +86 2161 630506
 F +86 2161 005672
 info.cn@zimmer-group.com
www.zimmer-group.cn

FRANCE:
ZIMMER GROUP FRANCE SARL
 8, Rue Sophie Germain
 FR 67720 Hoerdt
 T +33 388 833896
 F +33 388 833975
 info.fr@zimmer-group.com
www.zimmer-group.fr

GREAT BRITAIN, IRELAND:
ZIMMER GROUP (UK) LTD.
 Bretby Business Park
 108 Dovedale Building,
 Ashby Road, Bretby
 GB Burton on Trent, DE15 0YZ
 T +44 1283 542103
 F +44 5603 416852
 info.uk@zimmer-group.com
www.zimmer-group.co.uk

HEADQUARTER:
ZIMMER GROUP
 Am Glockenloch 2
 DE 77866 Rheinau
 T +49 7844 9139-0
 F +49 7844 9139-1199
 info.de@zimmer-group.com
www.zimmer-group.de

INDIA:
ZIMMER AUTOMATION LLP
 D 802, BRIZ
 Survey No. 451
 Kasar Amboli, Piragut
 IN 412108 Pune
 T + 91 91 30 083828
 info.in@zimmer-group.com
www.zimmer-group.in

ITALY:
ZIMMER GROUP ITALIA S.R.L.
 Viale Montegrappa, 7
 IT 27100 Pavia
 T +39 0382 571442
 F +39 0382 571473
 info.it@zimmer-group.com
www.zimmer-group.it

CANADA:
ZIMMER GROUP CANADA INC.
 26 Saunders Road
 CA L4N 9A8 Barrie, ON
 T +1 416766-6371
 F +1 416766-6370
 info.ca@zimmer-group.com
www.zimmer-group.ca

AUSTRIA:
ZIMMER GROUP
 T +43 664 2618940
 info.at@zimmer-group.com
www.zimmer-group.at

POLAND:
ZIMMER GROUP SLOVENSKO S.R.O.
 Ul. Widok 5
 PL 43-300, Bielsko-Biala
 T +421 42 4331-788
 F +421 42 4331-266
 info.pl@zimmer-group.com
www.zimmer-group.pl

SWITZERLAND, LIECHTENSTEIN:
**ZIMMER GMBH
 NIEDERLASSUNG SCHWEIZ**
 Westbahnhofstraße 2
 CH 4500 Solothurn
 T +41 32621-5152
 F +41 32621-5153
 info.ch@zimmer-group.com
www.zimmer-group.ch

SLOVAK REPUBLIC, CZECH REPUBLIC:
ZIMMER GROUP SLOVENSKO S.R.O.
 Centrum 1746/265
 SK Považská Bystrica 01706
 T +421 42 4331-788
 F +421 42 4331-266
 info.sk@zimmer-group.com
www.zimmer-group.sk

SPAIN, PORTUGAL:
ZIMMER GROUP IBERIA S.L.
 C./ Charles Darwin 5, Nave 11
 ES 28806 Alcalá de Henares/Madrid
 T +34 91 882 2623
 F +34 91 882 8201
 info.es@zimmer-group.com
www.zimmer-group.es

SOUTH KOREA:
ZIMMER GROUP KOREA LTD.
 1301 Byucksan digital valley 5,
 Beotkkot-ro 244, Geumcheon-Gu,
 KR 08513 Seoul
 T +82 2 2082-5651
 F +82 2 2082-5650
 info.kr@zimmer-group.com
www.zimmer-group.kr

TAIWAN, SINGAPORE, BRUNEI, CAMBODIA, INDONESIA, LAOS, MALAYSIA, MYANMAR, PHILIPPINES, THAILAND, VIETNAM, AUSTRALIA, NEW ZEALAND:
ZIMMER GROUP ASIA LTD.
 17F, No 61, Sec 2 Da Xing W. Rd.,
 Taoyuan Dist.
 TW 330 Taoyuan City
 T +866 3 301 8829
 F +866 3 301 8929
 info.asia@zimmer-group.com
www.zimmer-group.com

USA, COLOMBIA, MEXICO:
ZIMMER GROUP US INC.
 1095 6th Street Ct SE
 US Hickory, NC, 28602
 T +1 828 855 9722
 F +1 828 855 9723
 info.us@zimmer-group.com
www.zimmer-group.com