

slides

**LC Series**  
Light Duty Slide



Air-Oil Systems, Inc. [www.airoil.com](http://www.airoil.com)

**NUMATICS**

# Table of Contents



<b>LC Series</b> .....	3-9
Features and Benefits.....	3
How To Order.....	4
Dimensions.....	5
Technical Specifications.....	6
Switch Information.....	7-9

Air-Oil Systems, Inc. [www.airoil.com](http://www.airoil.com)



## LC Series

The “LC” series provides guided linear motion at a lower cost. External cylinder is mounted rigidly to the cross body which drives the tool plate. The tool plate motion is guided by two hardened linear rods. The linear rods are supported by engineered polymer plastic bushings.

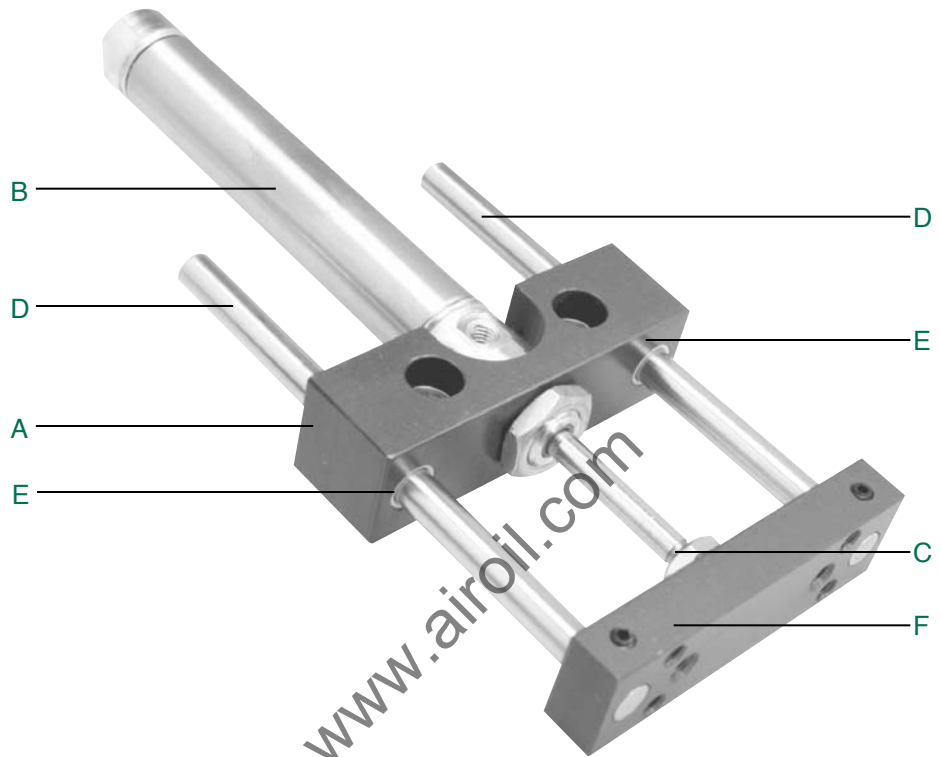

### A. Body:

Hardcoat anodized aluminum ..... lightweight, durable, high strength to weight ratio  
 Easy access mounting ..... drilled and counterbored for flush mount

### B. Air Cylinder:

Standard stainless steel body and piston rod ..... corrosion resistant  
 Standard with magnetic piston ..... sensing options, reed, hall effect and proximity able to be added in the field  
 Optional cushion control ..... decelerated motion on 1-1/16 bore and greater

### C. Alignment Coupler:

360 degrees of float ..... isolates air cylinder from destructive side loads maximum cylinder life

### D. Guide Shafts:

Hardened steel ..... hardness Rc60-65, low friction, long life  
 Optional stainless steel ..... hardness Rc50-55, corrosion resistant

### E. Bushings:

Engineered plastic polymer ..... low friction, high durability, no lubrication required  
 Maximum rigidity ..... superior rod diameter to bushing length ratio

### F. NuMate™ Mounting:

Direct mount mounting system ..... eliminates adapter and transition plate  
 Patent No. 5,560,281 ..... mounts directly to other Numatics Motion Control products



## LC Series

### How to Order

**LC 075 04 H 1 6 D XX**

#### Bore Sizes

- 056 = 9/16 Inch
- 075 = 3/4 Inch
- 106 = 1-1/16 Inches
- 150 = 1-1/2 Inches

#### Standard Stroke

- 01 = 1"
- 02 = 2"
- 03 = 3"
- 04 = 4"
- 05 = 5"
- 06 = 6"

#### Guide Shaft Type

- H = Hardened Steel Shafts
- S = Stainless Steel Shafts

#### Cylinder Type

- 1 = Buna-N Seals
- 2 = Viton Seals (no magnet)
- 3\* = Buna-N with Cushions\*
- 4\*\* = Viton Seals with Magnet

\*Head cushion factory set, see page 5 for dimensional changes.  
Available on bore sizes 106 and 150.

\*\* Max. Temperature of slide is 140° F.

\*When entering an order, DO NOT use spaces or dashes.

#### Options

- XX = No Options
- SE\* = Stop Collars for Extend Stroke Adjust
- SR\* = Stop Collars for Retract Stroke Adjust
- SB\* = Stop Collars for Extend and Retract
- \*Stop collars will be stainless when guide shafts are stainless

#### Sensing Position

- A = Single Position Extend
- B = Single Position Retract
- C = Extend and Retract
- D = No Sensing

#### Sensing Type

- Standard Cord Set
- 1 = Hall Effect - PNP (sourcing)
- 2 = Hall Effect - NPN (sinking)
- 3 = Reed Switch
- 4 = Prox Switch on Cylinder - PNP (sourcing)
- 5 = Prox Switch on Cylinder - NPN (sinking)
- 6 = No Sensing
- Quick Disconnect Cord Set
- Z = Hall Effect - PNP (sourcing)
- Y = Hall Effect - NPN (sinking)
- X = Reed Switch
- W = Prox Switch on Cylinder - PNP (sourcing) Straight
- V = Prox Switch on Cylinder - NPN (sinking) Straight
- U = Prox Switch on Cylinder - PNP (sourcing) 90 Deg.
- T = Prox Switch on Cylinder - NPN (sinking) 90 Deg.

Reference the sensing section of the catalog for sensing specifications.

Example order:

Part Number: LC07504H16DXX\*

Part Description: 3/4" diameter bore x 4" stroke, buna seals, hardened steel guide shafts, no switches, no special options.

\*When entering an order, DO NOT use spaces or dashes.

### When ordering additional accessories:

SWITCH DESCRIPTION	STANDARD PART NO.	QUICK DISCONNECT PART NO.
Hall Effect - PNP (Sourcing)	HPNPS31*	HPNPQ31*
Hall Effect - NPN (Sinking)	HNPNS32*	HNPNQ32*
Reed Switch	RSS02*	RSQ02*
Prox Switch - PNP (Sourcing)	SWPP - 0001	SWPP - QS01
Prox Switch - NPN (Sinking)	SWPN - 0001	SWPN - QS01
Prox Switch - PNP 90°	-	SWPP - QL01
Prox Switch - NPN 90°	-	SWPN - QL01
90° 5 meter cable	-	PXC90
Straight 5 meter cable	-	PXCST

\*Bands and tracks required for mounting.

Reference bracket in the Switch Application Chart in the Sensor section.



### LC Series Dimensions

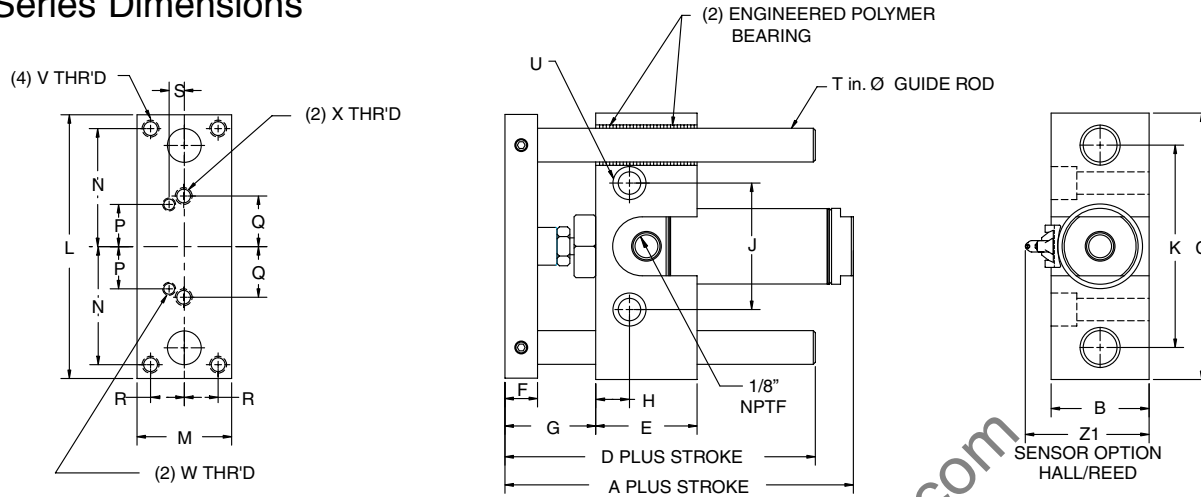

	LC056	LC075	LC106	LC150
A	2.97	3.75	4.16	4.75
B	0.75	0.98	1.45	1.75
C	2.50	3.40	3.95	5.00
D	2.11	2.78	3.60	3.94
E	0.75	1.00	1.50	1.50
F	0.36	0.47	0.48	0.625
G	0.86	1.09	1.34	1.56
H	0.375	0.50	0.50	0.50
J	1.25	1.50	1.875	2.25
K	2.00	2.50	3.00	3.75
L	2.46	3.36	3.91	4.97
M	0.70	0.94	1.40	1.72
N	0.75	1.50	1.75	2.25
P	--	0.50	0.625	0.750
Q	0.625	0.625	0.75	0.937
R	0.218	0.312	0.50	0.625
S	--	0.187	0.35	0.375
T	0.25	0.375	0.50	0.625
U	c'bore for #10 SHCS	c'bore for 1/4 SHCS	c'bore for 5/16 SHCS	c'bore for 5/16 SHCS
V	#8-32 thru	#10-32 thru	1/4-20 thru	5/16-18 thru
W	--	#6-32 Thru	#10-32 thru	1/4-20 thru
X	#10-32 thru	#10-32 thru	1/4-20 thru	5/16-18 thru
Z1	1.16	1.35	1.76	2.13

CUSHION CYLINDER OPTION				
	LC056	LC075	LC106	LC150
A	-	-	4.41	4.94

### Unit Weight Table

	LC056	LC075	LC106	LC150
Base Unit Weight	0.33	0.78	1.96	3.48
Adder/inch of stroke	0.05	0.11	0.15	0.28
Add base weight to inch adder X stroke	Sample weight calculation: Model LC075 W/3", .78 + (3x .11)=1.11lbs			

### Unit Output Force Table

	LC056	LC075	LC106	LC150
Extend Force (lbs)	0.24	0.44	0.88	1.76
Retract Force (lbs)	0.22	0.39	0.81	1.61
Multiply force factor X input pressure in psi	Sample output force calculation: Model LC075 extend force @ 70psi, 0.44 x 70=30.8lbs			



## LC Series

### Maximum Dynamic Load and Deflection Ratings

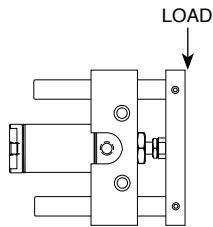

Position A

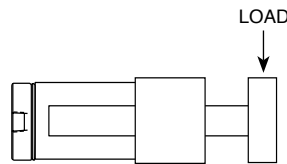

Position B

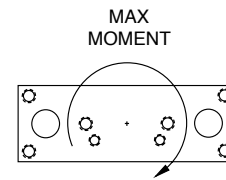

Position C

Stroke	LC056			LC075			LC106			LC150		
	Pos A&B Load (lbs)	Pos A&B Deflection (in)	Pos C Max Moment	Pos A&B Load (lbs)	Pos A&B Deflection (in)	Pos C Max Moment	Pos A&B Load (lbs)	Pos A&B Deflection (in)	Pos C Max Moment	Pos A&B Load (lbs)	Pos A&B Deflection (in)	Pos C Max Moment
1	3.00	0.0006	3 inlb	3.00	0.0002	5 inlb	8.0	0.0002	8 inlb	12.0	0.0015	12 inlb
2	1.50	0.0010	3 inlb	2.50	0.0004	5 inlb	4.0	0.0003	8 inlb	6.0	0.0020	12 inlb
3	1.00	0.0017	3 inlb	1.67	0.0007	5 inlb	2.7	0.0004	8 inlb	4.0	0.0028	12 inlb
4	0.75	0.0025	3 inlb	1.25	0.0009	5 inlb	2.0	0.0005	8 inlb	3.0	0.0038	12 inlb
5	0.60	0.0035	3 inlb	1.00	0.0013	5 inlb	1.6	0.0007	8 inlb	2.4	0.0050	12 inlb
6	0.50	0.0047	3 inlb	0.84	0.0017	5 inlb	1.3	0.0009	8 inlb	2.0	0.0064	12 inlb

### Rotational Clearance

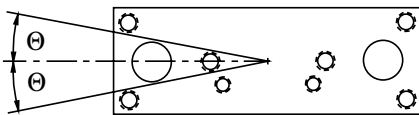

LC056	LC075	LC106	LC150
+/- 0.17°	+/- 0.15°	+/- 0.15°	+/- 0.15°

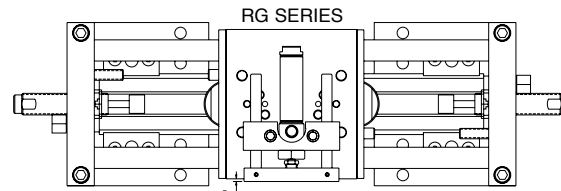
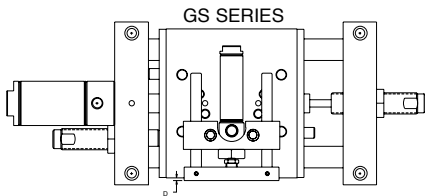
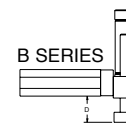
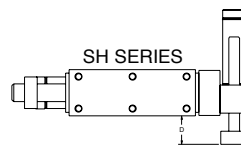
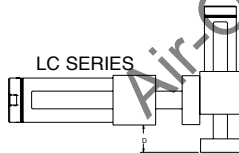

### NuMate™ Compatibility Table & Edge Reference

	LC056	LC075	LC106	LC150	SH056	SH075	SH106	SH150	SH200	GS075	GS106	GS150	GS200	RG25B	RG32C	RG32D	B04	B06	B08
LC056	0.86	0.75	0.86	-	0.73	0.92	-	-	-	-0.28	-0.14	-	-	-0.14	-	-	1.02	0.92	0.93
LC075	-	-	0.86	0.71	1.09	0.96	1.00	-	-	-0.54	-0.35	0.09	-	-0.35	0.09	-	-	-	0.97
LC106	-	-	-	0.96	-	-	1.09	1.15	-	-	-0.85	-0.41	-0.54	-0.85	-0.41	-0.54	-	-	-
LC150	-	-	-	-	-	-	-	0.93	1.18	-	-	-0.89	-1.02	-	-0.89	-1.02	-	-	-

\* All Dimensions in these charts are in inches



### LC Series Switch Information

	SWITCH OR BRACKET DESCRIPTION	STANDARD PART NO.	QUICK DISCONNECT PART NO.
1	Hall Effect - PNP (Sourcing)	HPNPS31	HPNPQ31
1	Hall Effect -NPN (Sinking)	HNPNS32	HNPNQ32
1	Reed Switch	RSS02	RSQ02
2	Short Switch Bracket	SBS-1	SBS-1
2	Long Switch Bracket**	SBL-2	SBL-2
3	Switch Band Clamp	SBC###*	SBC###*
4	Prox Switch - PNP (Sourcing)	SWPP-0001	SWPP-QS01
4	Prox Switch - NPN (Sinking)	SWPN-0001	SWPN-QS01

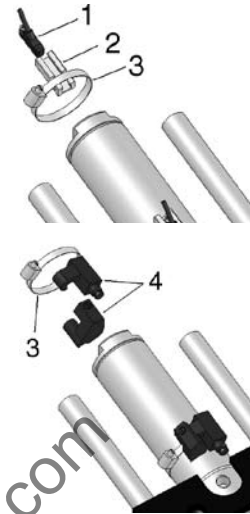

\*Use the 3 digit bore size with "SBC" number to complete part number  
 Example: LC15004H16DXX = Switch Band clamp p/n: SBC150

\*\* Long bracket used on strokes of 1" or less with two position sensing.

### RSS02 – Reed Switch (AC/DC NO), flying lead

### RSQ02 – 8mm connector

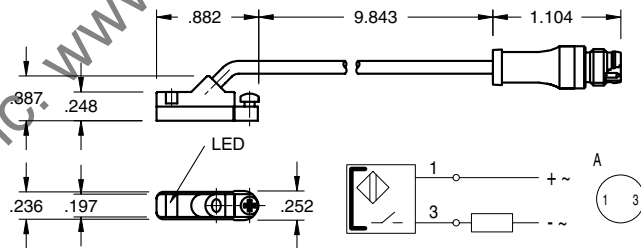
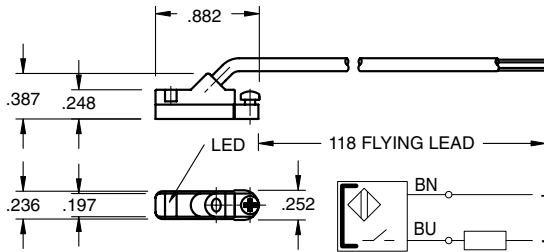

#### Sensing Data

Ambient temperature range $T_a$	(°F/°C)	-4 to 176 (-20 to 80)
Frequency of operating cycles $f$ at $U_e$	(kHz)	0.5
Turn on time $t$	(ms)	$\leq 0.25$
turn off time $t$	(ms)	0.03
LED function indication		yes

#### Electrical Data

Rated operational voltage $U_e$	(V)	3...130 AC/DC
Supply voltage $U_B$	(V)	3...130 AC/DC
Voltage drop $U_d$ at $I_e$ Stat./dyn.	(V)	3.5
Rated insulation voltage $U_i$	(V)	2750 DC (EN 60335-1)
Rated supply frequency	(Hz)	AC/DC
Rated operational current $I_e$	(mA)	50 (10W max.)
No-load supply current $I_o$ at $U_e$ d./und.	(mA)	0

Observe polarity for correct LED function

#### Mechanical Data

Housing material	Polyamide
Material of sensing face	Polyamide
Connection	PVC cable
Degree of Protection	IP 67
Rated shock: half-sinus, 50g, 11 ms	
Rated vibration environment: 10g, 10...2000 Hz. 90 min	





## LC Series

### HPNPS31 – Electronic Switch (PNP NO), flying lead

### HPNPQ31 – 8mm connector

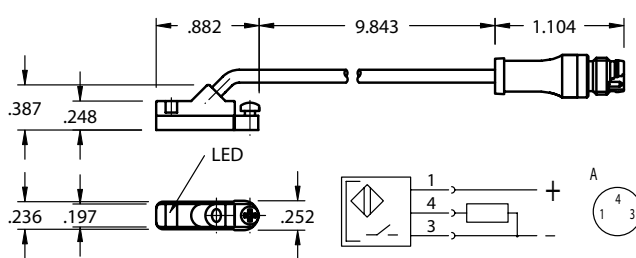
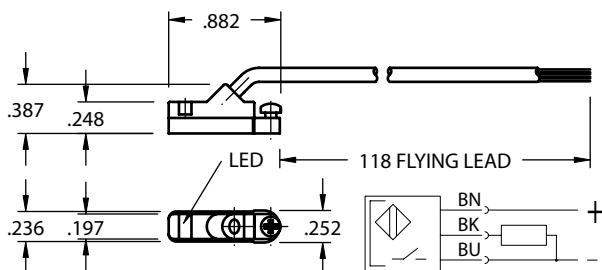

#### Sensing Data

Ambient temperature range $t_d$	(°F/°C)	-13 to +158 (-25 to +70)
Temperature drift	(% of )	$\leq 0.3\%/^{\circ}\text{C}$
Frequency of operating cycles $f$ at $U_e$	(kHz)	10
Turn on time $t$	(ms)	.05
Turn off time $t$	(ms)	.05
Utilization categories		DC13
Function—supply voltage indication		YES

#### Electrical Data

Rated operational voltage $U_e$	(V)	24 DC
Supply voltage $U_B$	(V)	10...30 DC
incl. ripple	(% of $U_e$ )	15
Voltage drop $U_d$ at $I_e$ Stat./dyn.	(V)	1/-
Rated insulation volatage $U_i$	(V)	75 AC
Rated supply frequency	(Hz)	DC
Rated operational current $I_e$	(mA)	200
No-load supply current $I_0$ at $U_e$ d./und.	(mA)	25/13
Protected against polarity reversal		YES

#### Mechanical Data

Housing material	Polyamide
Material of sensing face	Polyamide
Connection	PVC cable
Degree of Protection	IP 67
Rated shock: half-sinus, 30 g, 11 ms	
Rated vibration environment: 55 Hz, 1mm amplitude, 3 x 30	



### HNPNS32 – Electronic Switch (NPN NO), flying lead

### HNPNQ32 – 8mm connector

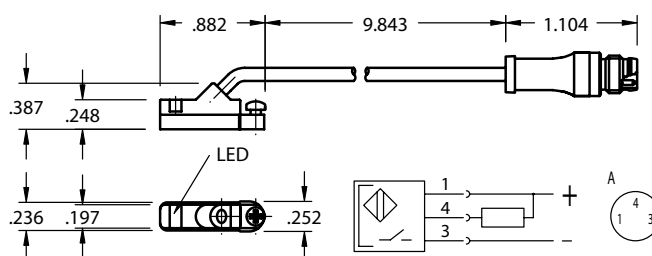
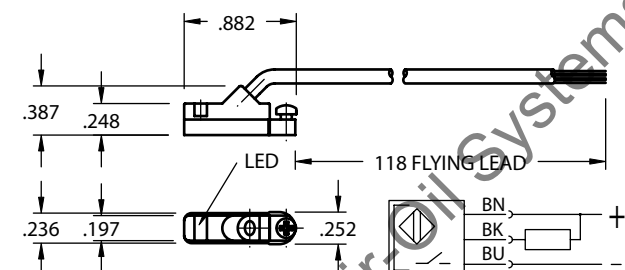

#### Sensing Data

Ambient temperature range $t_d$	(°F/°C)	-13 to +158 (-25 to +70)
Temperature drift	(% of $S_T$ )	$\leq 0.3\%/^{\circ}\text{C}$
Frequency of operating cycles $f$ at $U_e$	(kHz)	10
Turn on time $t$	(ms)	.05
Turn off time $t$	(ms)	.05
Utilization categories		DC13
Function—supply voltage indication		YES

#### Electrical Data

Rated operational voltage $U_e$	(V)	24 DC
Supply voltage $U_B$	(V)	10...30 DC
incl. ripple	(% of $U_e$ )	15
Voltage drop $U_d$ at $I_e$ Stat./dyn.	(V)	1/-
Rated insulation volatage $U_i$	(V)	75 AC
Rated supply frequency	(Hz)	DC
Rated operational current $I_e$	(mA)	200
No-load supply current $I_0$ at $U_e$ d./und.	(mA)	25/13
Protected against polarity reversal		YES

#### Mechanical Data

Housing material	Polyamide
Material of sensing face	Polyamide
Connection	PVC cable
Degree of Protection	IP 67
Rated shock: half-sinus, 30 g, 11 ms	
Rated vibration environment: 55 Hz, 1mm amplitude, 3 x 30	







SWPP-0001 (PNP NO), flying lead  
SWPN-0001 (NPN NO), flying lead

SWPP-QS01 – 8 mm connector  
SWPN-QS01 – 8 mm connector

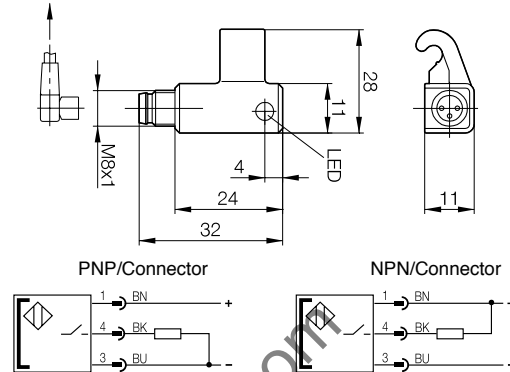
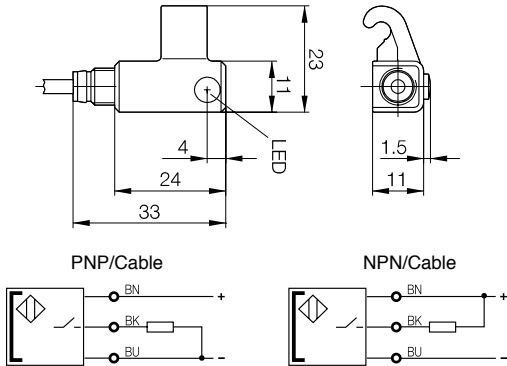

Hysteresis of I <sub>Hn</sub> I	≤45%
Temperature drift of turn-on point of I <sub>Hn</sub> I	≤0.3%/°C
Turn-on delay	≤0.5 ms
Turn-off delay	≤0.5 ms
Supply voltage U <sub>B</sub>	10...30 Vdc
Voltage drop U <sub>d</sub>	≤3.1 V
Rated insulation voltage U <sub>i</sub>	75 Vdc
Rated operating current I <sub>e</sub>	200 mA <sup>1</sup>
No-load supply current I <sub>o</sub> max.	≤30 mA
Off-state current I <sub>r</sub>	≤80 μA
Protected against polarity reversal	yes
Short circuit protected	yes
Load capacitance	≤1 μF
Ambient temperature range T <sub>a</sub>	-25°C...+70°C
Utilization category	DC 13
Degree of protection per IEC 60529	IP 67
Housing material	PBT Hardened

## Female Connectors for Reed Switches and Hall Effect Sensors

Dimensions (mm)

TYPE	ORDER CODE
Straight, 5 m Cable	PXCST
Elbow, 5 m Calbe	PXC90

Straight Type

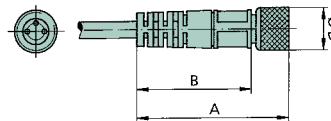

Elbow Type

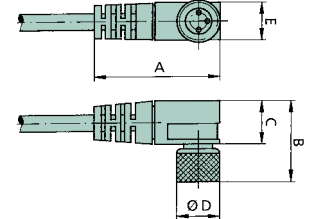

# NUMATICS

World Class Supplier  
of Pneumatic Components

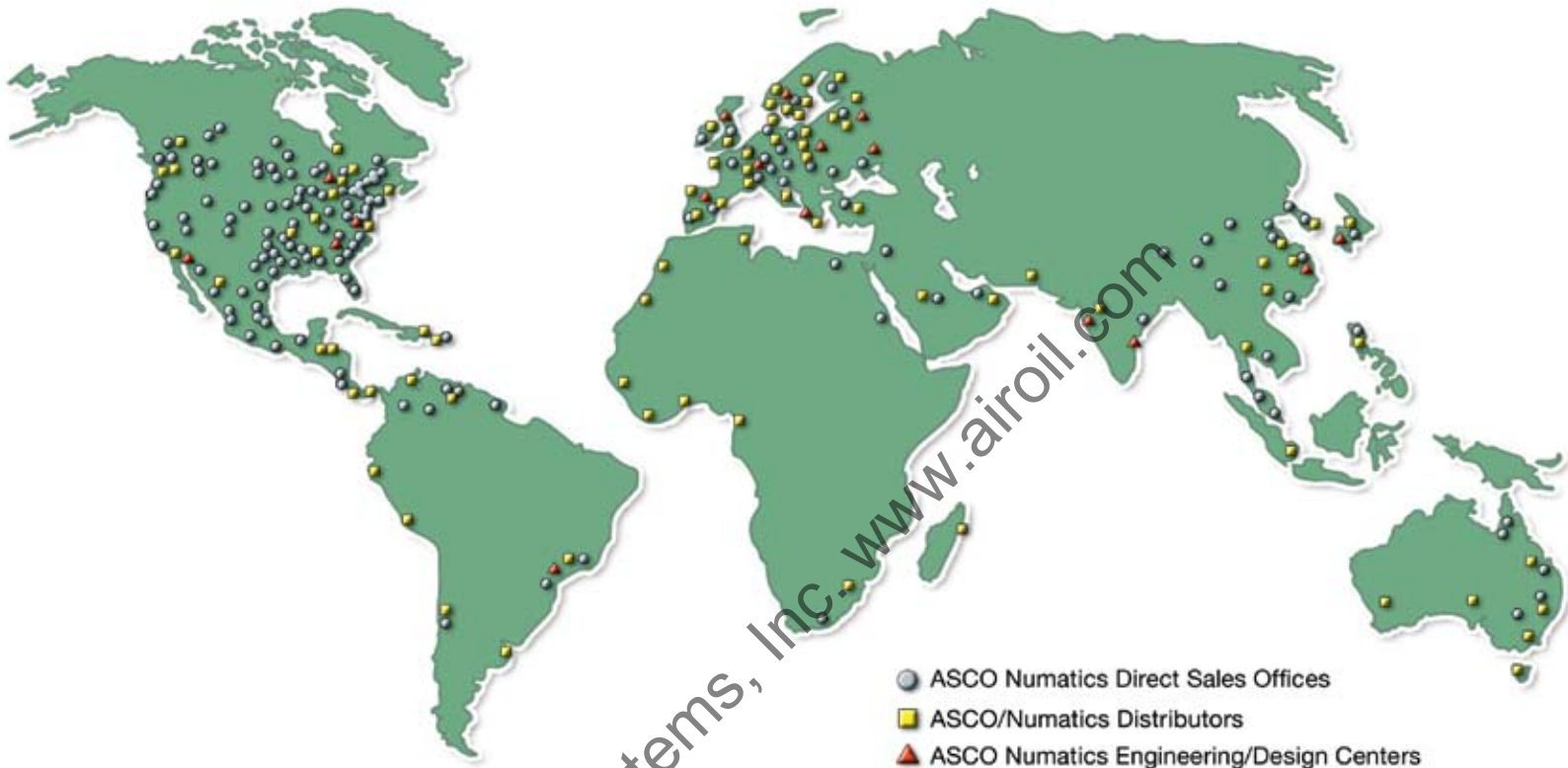

## WORLD HEADQUARTERS

### USA

#### Numatics, Incorporated

46280 Dylan Drive  
Novi, Michigan 48377

P: 1-888-Numatics  
1-888-686-2842

### Canada

#### Numatics, Ltd

P: 519-452-1777

### Mexico

#### Numatics de Mexico S.A. de C.V.

P: 52-222-284-6176

For a comprehensive listing of all Numatics production and distribution facilities worldwide, visit:

[www.numatics.com](http://www.numatics.com)