

slides

LCX Series

Linear Slide



Air-Oil Systems, Inc. www.airoil.com

NUMATIC[®]

Table of Contents



LCX Series	3-8
Features and Benefits	3
How to Order	4
Dimensions	5
Technical Specifications	5
Switch Information	6-8

Air-Oil Systems, Inc. www.airoil.com



LCX Series

The LCX combines cost-effectiveness with proven dependability. An economical alternative with greater load carrying capabilities.

- Low Cost
- High Load Capability
- Stainless Steel Shafts Available
- Engineered Plastic Polymer Bearing
- Available in 3 Bore Sizes



A. Body:

Hardcoat anodized aluminum.....Lightweight, durable, high strength Increased load carrying capability

B. Alignment Coupler:

360 Degrees of float.....isolates air cylinder from destructive side loads maximum cylinder life

C. Bushings:

Engineered plastic polymer.....Low friction, high durability, no lubrication required Maximum rigidity.....superior rod diameter to bushing length ratio

D. NuMate™ Mounting:

Direct mount mounting system....Mount other Numatics products directly to tooling plate

Air-Oil Systems, Inc. www.airoil.com



LCX Series

How to Order

LCX 075 04 H 1 6 D XX

Bore Size

075 = 3/4"
106 = 1-1/16"
150 = 1-1/2"

Standard Stroke

X5 = 1/2" 08 = 8"
01 = 1" 09 = 9"
X9 = 1-1/2" 10 = 10"
02 = 2" 11 = 11"
03 = 3" 12 = 12"
04 = 4" 13 = 13"
05 = 5" 14 = 14"
06 = 6" 15 = 15"
07 = 7"

Guide Shaft Type

H = Hardened Steel
S = Stainless Steel

Cylinder Type**

1 = Buna-N Seals
2 = Viton Seals / No Magnet
3 = Buna-N Seals w/Cushions*
4 = Viton Seals / with Magnet

*Head cushion factory set available on bore sizes 106 and 150.

**Max temperature for LCX Series is 140°F.

Options

XX = No Options
SE = Stop Collars for Extend Stroke Adjust*
SR = Stop Collars for Retract Stroke Adjust*
SB = Stop Collars for Extend and Retract
*Stop collars will be stainless when the guide shafts are stainless.

Sensing Position

A = Single Position Extend
B = Single Position Retract
C = Two Position Sensing
D = No Sensing

Sensing Type

Standard Cord Set
1 = Hall Effect - PNP (sourcing)
2 = Hall Effect - NPN (sinking)
3 = Reed Switch
4 = Prox Switch on Cylinder - PNP (sourcing)
5 = Prox Switch on Cylinder - NPN (sinking)
6 = No Sensing
Quick Disconnect Cord Set
Z = Hall Effect - PNP (sourcing)
Y = Hall Effect - NPN (sinking)
X = Reed Switch
W = Prox Switch on Cylinder - PNP (sourcing) Straight
V = Prox Switch on Cylinder - NPN (sinking) Straight
U = Prox Switch on Cylinder - PNP (sourcing) 90 Deg.
T = Prox Switch on Cylinder - NPN (sinking) 90 Deg.

When ordering additional accessories:

SWITCH DESCRIPTION	STANDARD PART NO.	QUICK DISCONNECT PART NO.
Hall Effect - PNP (Sourcing)	HPNPS31*	HPNRQ31*
Hall Effect - NPN (Sinking)	HNPNS32*	HNPNQ32*
Reed Switch	RSS02*	RSQ02*
Prox Switch - PNP (Sourcing)	SWPP - 0001	SWPP - QS01
Prox Switch - NPN (Sinking)	SWPN - 0001	SWPN - QS01
Prox Switch - PNP 90°	-	SWPP - QL01
Prox Switch - NPN 90°	-	SWPN - QL01
90° 5 meter cable	-	PXC90
Straight 5 meter cable	-	PXCST

*Bands and tracks required for mounting.

Reference bracket in the Switch Application Chart in the Sensor section.



LCX Series Dimensions and Specifications

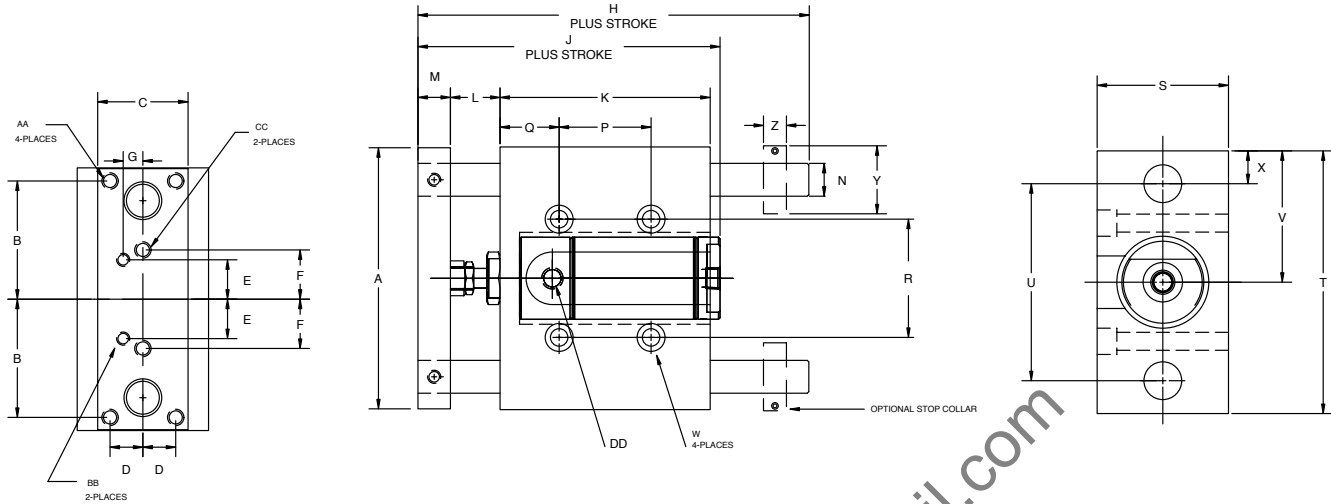

BORE	A	B	C	D	E	F	G	H	J	K	L	M	N	P
0.750	3.36	1.50	0.94	0.31	0.50	0.62	0.18	4.06	3.75	2.28	0.62	0.47	0.37	0.94
1.062	3.90	1.75	1.40	0.50	0.62	0.75	0.23	4.66	4.24	2.57	0.82	0.48	0.50	1.37
1.500	4.97	2.25	1.72	0.62	0.75	0.93	0.37	6.43	4.75	4.00	0.94	0.61	0.62	1.75

BORE	Q	R	S	T	U	V	W	X	Y	Z	AA	BB	CC	DD
0.750	0.51	1.50	1.25	3.40	2.50	1.70	C'bored for 1/4 SHCS	0.45	0.87	0.35	10-32 thru	6-32 thru	10-32 thru	1/8 NPTF
1.062	0.38	1.87	2.00	3.95	3.00	1.97	C'bored for 5/16 SHCS	0.47	1.12	0.41	1/4-20 thru	10-32 thru	1/4-20 thru	1/8 NPTF
1.500	1.12	2.25	2.50	5.00	3.75	2.50	C'bored for 5/16 SHCS	0.62	1.29	0.43	5/16-18 thru	1/4-20 thru	5/16-18 thru	1/8 NPTF

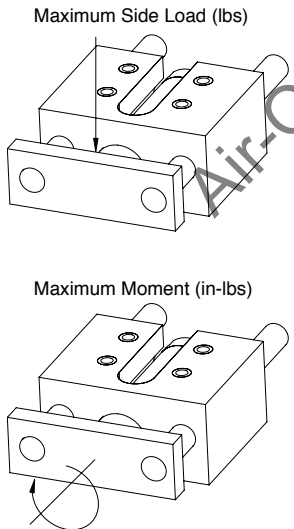

Maximum Side Loads (lbs) Maximum Moment (in-lbs)

STROKE	LCX 075	LCX 106	LCX 150	LCX 075	LCX 106	LCX 150
1	102	165	273	108	259	546
2	82	136	233	87	212	466
3	66	116	199	70	181	398
4	55	98	170	58	153	340
5	45	86	144	48	134	288
6	39	74	124	41	116	248
7	34	65	109	36	101	218
8	30	57	97	32	89	194
9	26	52	87	28	81	174
10	24	47	79	26	73	158
11	22	43	72	23	67	144
12	20	39	66	21	61	132
13	19	36	62	20	57	124
14	17	34	58	19	53	117
15	16	32	55	17	50	110

Unit Output Force

	LCX 075	LCX 106	LCX 150
Extend Force (lbs)	0.44	0.88	1.76
Retract Force (lbs)	0.39	0.81	1.61

Multiply force factor X input pressure in psi
 Example: LCX075 extend force @ 70psi .44 X 70= 30.8

Static Rating



LCX Series Switch Information

SWITCH OR BRACKET DESCRIPTION	STANDARD PART NO.	QUICK DISCONNECT PART NO.
1 Hall Effect - PNP (Sourcing)	HPNPS31	HPNPQ31
1 Hall Effect -NPN (Sinking)	HNPNS32	HNPNQ32
1 Reed Switch	RSS02	RSQ02
2 Short Switch Bracket	SBS-1	SBS-1
2 Long Switch Bracket**	SBL-2	SBL-2
3 Switch Band Clamp	SBC###*	SBC###*
4 Prox Switch - PNP (Sourcing)	SWPP-0001	SWPP-QS01
4 Prox Switch - NPN (Sinking)	SWPN-0001	SWPN-QS01

*Use the 3 digit bore size with "SBC" number to complete part number
 Example: LCX15004H16DXX = Switch Band clamp p/n: SBC150

** Long bracket used on strokes of 1" or less with two position sensing.

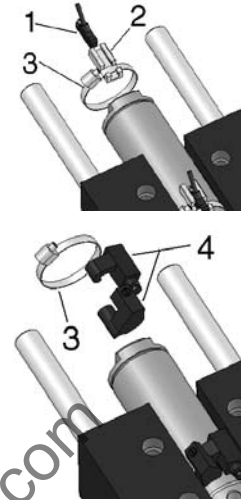

RSS02 – Reed Switch (AC/DC NO), flying lead

RSQ02 – 8mm connector

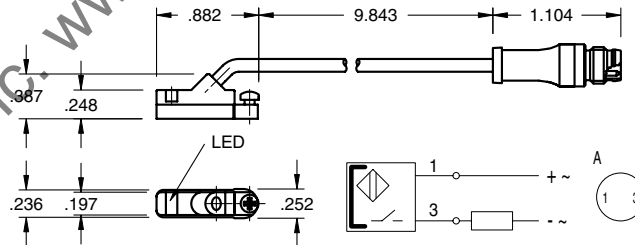
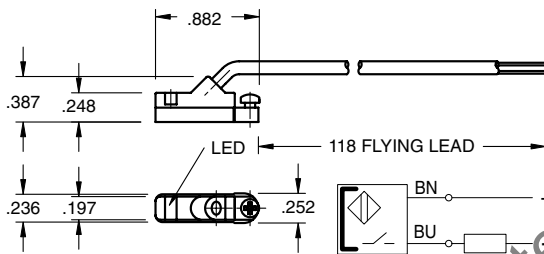

Sensing Data

Ambient temperature range T_a	(°F/°C)	4 to 176 (-20 to 80)
Frequency of operating cycles f at U_e	(kHz)	0.5
Turn on time t	(ms)	≤ 0.25
Turn off time t	(ms)	0.03
LED function indication		yes

Electrical Data

Rated operational voltage U_e	(V)	3...130 AC/DC
Supply voltage U_B	(V)	3...130 AC/DC
Voltage drop U_d at I_e Stat./dyn.	(V)	3.5
Rated insulation voltage U_i	(V)	2750 DC (EN 60335-1)
Rated supply frequency	(Hz)	AC/DC
Rated operational current I_e	(mA)	50 (10W max.)
No-load supply current I_o at U_e d./und.	(mA)	0

Mechanical Data

Housing material	Polyamide
Material of sensing face	Polyamide
Connection	PVC cable
Degree of Protection	IP 67
Rated shock: half-sinus, 50g, 11 ms	
Rated vibration environment: 10g, 10...2000 Hz. 90 min	





HPNPS31 – Electronic Switch (PNP NO), flying lead

HPNPQ31 – 8mm connector

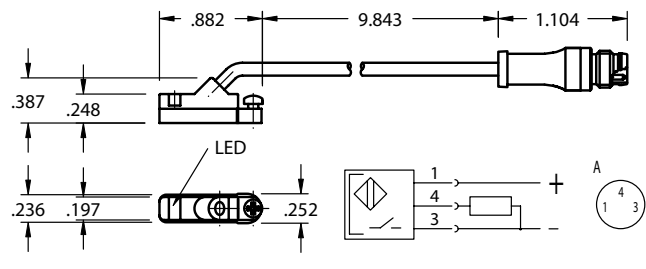
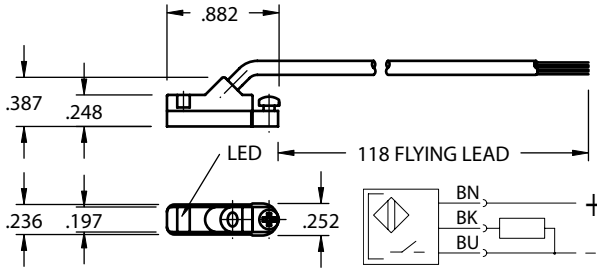

Sensing Data

Ambient temperature range ϑ	(°F/°C)	-13 to +158 (-25 to +70)
Temperature drift	(% of)	$\leq 0.3\%/^{\circ}\text{C}$
Frequency of operating cycles f at U_e	(kHz)	10
Turn on time t	(ms)	.05
Turn off time t	(ms)	.05
Utilization categories		DC13
Function—supply voltage indication		YES

Electrical Data

Rated operational voltage U_e	(V)	24 DC
Supply voltage U_B	(V)	10...30 DC
incl. ripple	(% of U_e)	15
Voltage drop U_d at I_e Stat./dyn.	(V)	1/-
Rated insulation voltage U_i	(V)	75 AC
Rated supply frequency	(Hz)	DC
Rated operational current I_e	(mA)	200
No-load supply current I_0 at U_e d./und.	(mA)	25/13
Protected against polarity reversal		YES

Mechanical Data

Housing material	Polyamide
Material of sensing face	Polyamide
Connection	PVC cable
Degree of Protection	IP 67
Rated shock: half-sinus, 30 g, 11 ms	
Rated vibration environment: 55 Hz, 1mm amplitude, 3 x 30	



HNPNS32 – Electronic Switch (NPN NO), flying lead

HNPNQ32 – 8mm connector

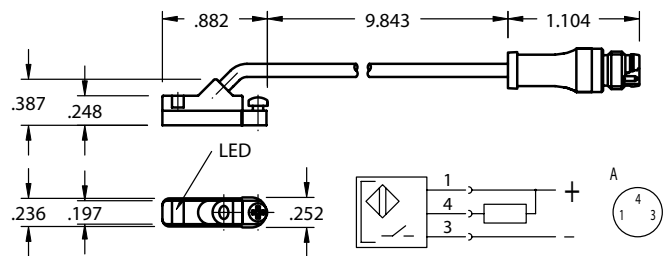
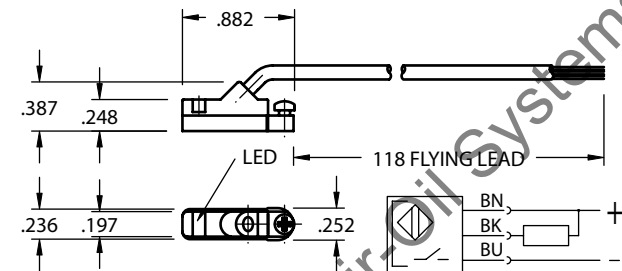

Sensing Data

Ambient temperature range ϑ	(°F/°C)	-13 to +158 (-25 to +70)
Temperature drift	(% of S_T)	$\leq 0.3\%/^{\circ}\text{C}$
Frequency of operating cycles f at U_e	(kHz)	10
Turn on time t	(ms)	.05
Turn off time t	(ms)	.05
Utilization categories		DC13
Function—supply voltage indication		YES

Electrical Data

Rated operational voltage U_e	(V)	24 DC
Supply voltage U_B	(V)	10...30 DC
incl. ripple	(% of U_e)	15
Voltage drop U_d at I_e Stat./dyn.	(V)	1/-
Rated insulation voltage U_i	(V)	75 AC
Rated supply frequency	(Hz)	DC
Rated operational current I_e	(mA)	200
No-load supply current I_0 at U_e d./und.	(mA)	25/13
Protected against polarity reversal		YES

Mechanical Data

Housing material	Polyamide
Material of sensing face	Polyamide
Connection	PVC cable
Degree of Protection	IP 67
Rated shock: half-sinus, 30 g, 11 ms	
Rated vibration environment: 55 Hz, 1mm amplitude, 3 x 30	





LCX Series

SWPP-0001 (PNP NO), flying lead
 SWPN-0001 (NPN NO), flying lead

SWPP-QS01 (PNP NO) - 8mm connector
 SWPN-QS01 (NPN NO) - 8mm connector

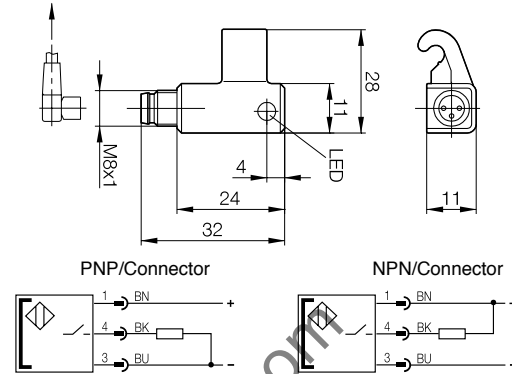
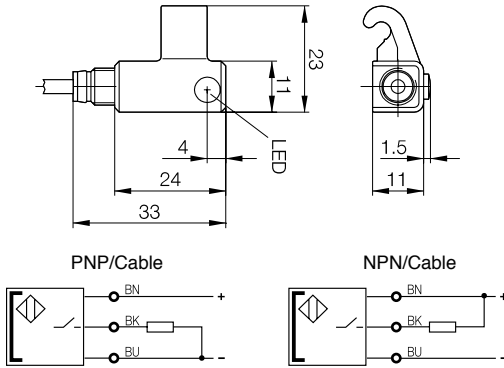

- | | |
|---|---------------------|
| Hysteresis of I _{Hn} I | ≤45% |
| Temperature drift of turn-on point of I _{Hn} I | ≤0.3%/°C |
| Turn-on delay | ≤0.5 ms |
| Turn-off delay | ≤0.5 ms |
| Supply voltage U _B | 10...30 Vdc |
| Voltage drop U _d | ≤3.1 V |
| Rated insulation voltage U _i | 75 Vdc |
| Rated operating current I _e | 200 mA ¹ |
| No-load supply current I _o max. | ≤30 mA |
| Off-state current I _r | ≤80 μA |
| Protected against polarity reversal | yes |
| Short circuit protected | yes |
| Load capacitance | ≤1 μF |
| Ambient temperature range T _a | -25°C...+70°C |
| Utilization category | DC 13 |
| Degree of protection per IEC 60529 | IP 67 |
| Housing material | PBT Hardened |

Female Connectors for Reed Switches and Hall Effect Sensors

Dimensions (mm)

TYPE	ORDER CODE
Straight, 5 m Cable	PXCST
Elbow, 5 m Calbe	PXC90

Straight Type

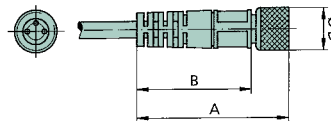

Elbow Type

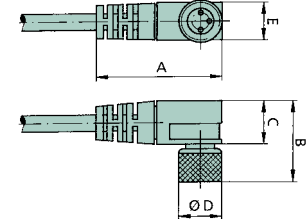

NUMATICS

*World Class Supplier
of Pneumatic Components*

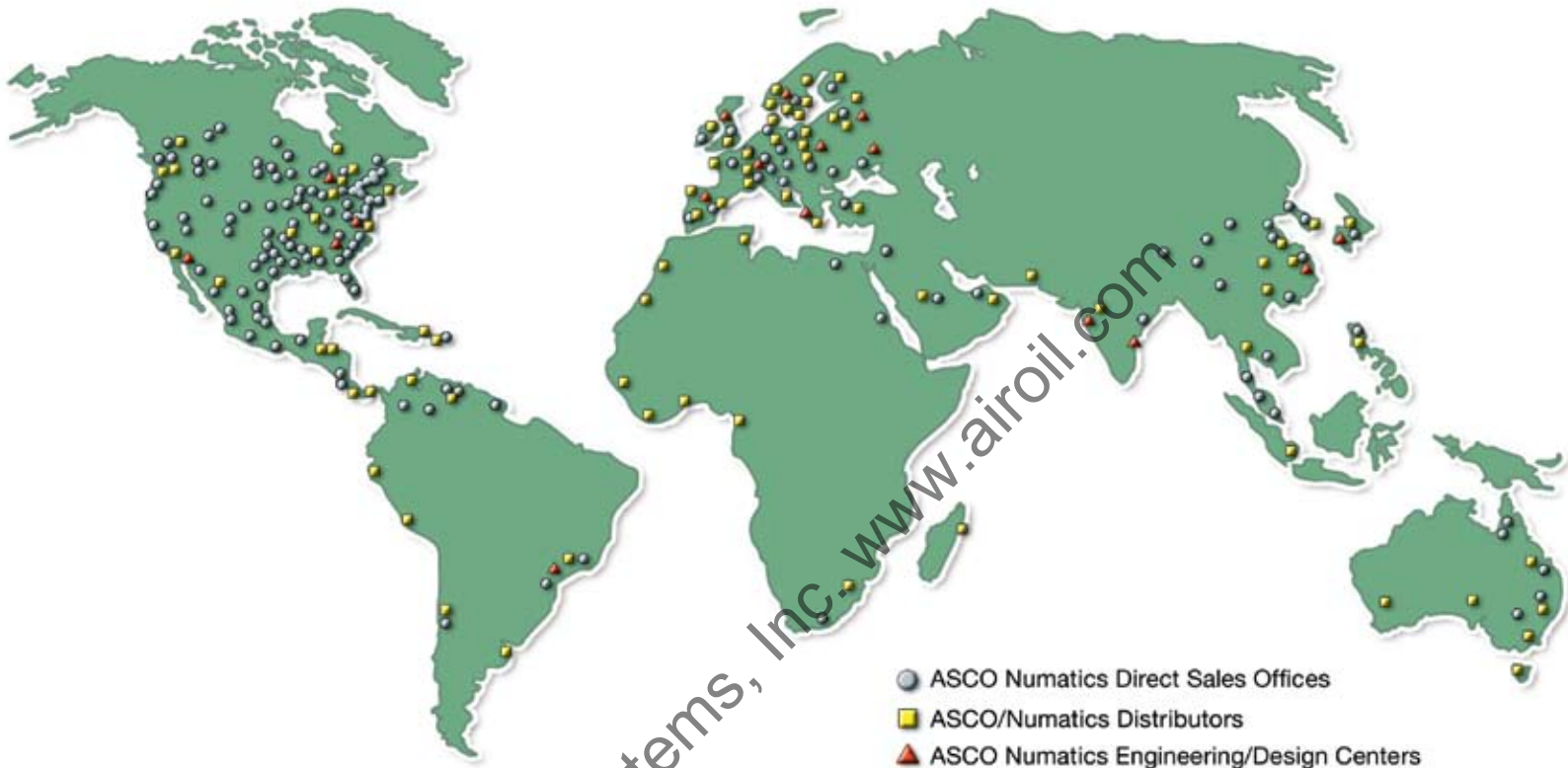

WORLD HEADQUARTERS

USA

Numatics, Incorporated

46280 Dylan Drive
Novi, Michigan 48377

P: 1-888-Numatics
1-888-686-2842

Canada

Numatics, Ltd

P: 519-452-1777

Mexico

Numatics de Mexico S.A. de C.V.

P: 52-222-284-6176

For a comprehensive listing of all Numatics production and distribution facilities worldwide, visit:

www.numatics.com