

FLAIRLINE
FAST
Shipped in 3-5 days



THE LIGHT-WEIGHT
LINE WITH
HEAVY-DUTY
FEATURES

TABLE OF CONTENTS

FLAIRLINE HI-CYCLE CYLINDER FEATURES F, O, H, D, M and DM Type Cylinders	3	ORDERING INSTRUCTIONS F, O, H, D, I, DI, SI, DSI and Digit-Air® Type Cylinders..	18
FLAIRLINE CYLINDERS AND VALVES A Flair For Reliability, Availability, Economy and Service..	4	ORDERING INSTRUCTIONS Magnetic Switch Cylinders	19
DOUBLE-ACTING CYLINDERS Series F, O, OLF, H and D	5	CYLINDER FEATURES - NFPA INTERCHANGEABLE NFPA Type Cylinders	20
SINGLE-ACTING CYLINDERS Series FSR, OSR, HSR and DSR	5	DOUBLE-ACTING CYLINDERS - NFPA INTERCHANGEABLE Series FI, OI and OILF	21
DOUBLE-ACTING DOUBLE-ENDED CYLINDERS Series FDE, ODE, HDE and DDE	6	DOUBLE-ACTING DOUBLE-ENDED CYLINDERS - NFPA INTERCHANGEABLE Series FIDE and OIDE	21
TANDEM CYLINDERS Series FT and DT	6	MAGNETIC SWITCH CYLINDERS - NFPA INTERCHANGEABLE Series OIM	22
CAP-TO-CAP CYLINDERS Series FCC, OCC, HCC and DCC	6	DOUBLE-ACTING NON-ROTATING CYLINDERS - NFPA INTERCHANGEABLE Series FINR, OINR and OIMNR	22
DIMENSIONAL DATA F, O, H and D Type Cylinders	7	DIMENSIONAL DATA - NFPA INTERCHANGEABLE Series FI, OI, OILF, OIM, FIDE and OIDE	23
MAGNETIC SWITCH CYLINDERS M, DM and Digit-Air M Type Cylinders	8	DIMENSIONAL DATA - NFPA INTERCHANGEABLE Series FINR, OINR and OIMNR	23
SWITCH OPTIONS Magnetic Switch Cylinders	8	MOUNTING STYLES - NFPA INTERCHANGEABLE NFPA Type Cylinders and Series VC	24
DIMENSIONAL DATA M and DM Type Cylinders	9	MOUNTING STYLES - NFPA INTERCHANGEABLE NFPA Type Cylinders	25
DIMENSIONAL DATA Digit-Air M Type Cylinders	10	ROD END STYLES - NFPA INTERCHANGEABLE Series FI, OI, OILF, OIM, FIDE and OIDE	25
MOUNTING ACCESSORIES F, O, H, D, M and DM Type Cylinders	10	ACCESSORIES - NFPA INTERCHANGEABLE NFPA Type Cylinders	26
INTERCHANGE SERIES I Type Cylinders	11	VOLUME CHAMBERS Series VC	27
INTERCHANGE SERIES DI Type Cylinders	12	SPECIAL OPTIONS - NFPA INTERCHANGEABLE NFPA Type Cylinders	28
INTERCHANGE SERIES SI Type Cylinders	13	ORDERING INSTRUCTIONS - NFPA INTERCHANGEABLE NFPA Type Cylinders and Series VC	29
INTERCHANGE SERIES DSI Type Cylinders	14	CHECK VALVES Series CV	30
MINIATURE CYLINDERS Digit-Air Type Cylinders	15	FLOW CONTROLS Series RFC	30
SPECIAL OPTIONS F, O, H, D, M, DM, I, DI, SI and DSI Type Cylinders	16	FLOW CHARTS Series CV and RFC	31
SPECIAL OPTIONS Digit-Air and Digit-Air M Type Cylinders	16	ORDERING INSTRUCTIONS Series CV and RFC	31
MAINTENANCE INSTRUCTIONS F, O, H, D, M, DM, I, DI, SI and DSI Type Cylinders	17		
APPLICATION TIPS Cylinders	17		



1. Chrome-plated, high-strength, steel piston rods are corrosion resistant, rugged and durable. Wrench flats behind full rod diameter threads permit easy clevis mounting.

2. High-quality elastomer rod wiper protects rod seal by preventing contaminants from entering cylinder during retract stroke. Resilient synthetic rubber will not scratch rod.

3. Pressure-energized, U-cup type rod seal is wear compensating, low friction and provides positive sealing.

4. Extra large mounting threads and rabbets make on-the-job mounting installation fast and secure.

5. Lightweight aluminum heads and caps for long corrosion-resistant life.

6. Extra-long, low-friction nylon rod bearing 'gives' rather than wears under normal side loading. When necessary, service is easy; only the bearing is replaced, not the head. Permanent bronze rod bearing is featured on D and DM type cylinders for extra side load capability.

7. Heads and caps are held to barrel by means of a circumflex key. The large square steel locking device requires no special installation tools. Service to head or cap can be done without disassembling the entire cylinder. See page 17 for easy maintenance details.

8. Adjustable cushions, available on 2" bore and larger, are flush with the O.D. of the cylinder. 1¹/₈" and 1¹/₂" bores have fixed cushions.

9. Cushion seal 'check valve' offers fast break-away, self-aligning, positive cushioning for faster stroking and reduced cylinder wear.

10. Precision-drawn, lightweight aluminum barrels are hard-anodized inside and out for corrosion and abrasion resistance. Fine I.D. microfinish provides long life and positive sealing.

11. Several piston styles are offered for various application requirements. See page 5 for F, O, H and D type pistons; page 8 for M and DM type pistons.

Hi-Cycle Means Value

You can select Flairline products with confidence.

They are expertly designed, made of the finest materials available, and carefully assembled. Aluminum construction for light weight, quality seals for reliability and unique features such as the 'uni-piston' and dilating O-ring combine to give you outstanding product performance. Our design specifications are precisely held during manufacture and every individual product must pass stringent functional tests before they are considered customer-ready.

After testing is completed, Flairline/Fast shipping assures that Flairline products are shipped to our distributors or directly to the customers within three to five working days. Flairline understands that availability is important.

So is price. Flairline products are surprisingly inexpensive, rapidly repaying your low initial investment with long, trouble-free operation. Quality design and easy reparability enhance production and add value to your equipment.

Should Flairline cylinders and valves need service, we provide that, too. Our interest in your complete satisfaction doesn't end after the sale. With repair kits,

parts and even spare cylinders available from coast to coast, Flairline is prepared to handle any emergency and minimize downtime.

Make your selections with complete confidence from our extensive line of low cost, fast-action pneumatic or hydraulic cylinders and valves.

Special Products

Flairline standard products offer a wide variety of application capabilities. No matter how extensive a product line may be, there is often a need for something unique for your special application. Responding to this need is important to Flairline. We are pleased to offer our capabilities to manufacture cylinder and valve products to your specifications.

Contact your local Flairline stocking distributor for more information.

CAD Files On Disk

*CAD product drawings are available in DXF or DWG formats for use with this catalog. These drawings can also be downloaded from our Web site at **www.flairline.com***

DOUBLE-ACTING CYLINDERS

FLAIRLINE HI-CYCLE

SERIES F, O, OLF, H AND D



Flairline double-acting cylinders can be used in nearly all types of applications where lightweight, economical, long-service actuators are required. Operating systems can be pneumatic or hydraulic. **Low friction pneumatic service is available with Series OLF, which is designed primarily for use in low pressure applications and where low minimum breakaway is required.** When side load conditions are present, select Series D with piston wear strip and bronze rod bearing. Precision components and sealing elements permit continuous operation in any environment. See page 7 for dimensional data and page 10 for mounting accessories. For special options, see page 16.

For ordering information, see page 18.

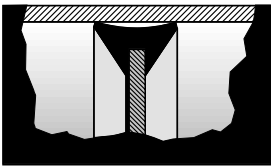

F TYPE PISTON

Pressure energized, wear compensating double lip type, 'uni-piston' seal (Buna N). Rubber bonded to a plated disc to assure positive sealing, will outlast O-rings and can never score cylinder I.D.

F

Standard Bore Sizes – 1¹/₈, 1¹/₂, 2, 2¹/₂, 3¹/₄, 4
Stock Stroke Sizes – 1" to 18" (1" increments)
Cushions available – either/both ends
Pneumatic only – 150 psi maximum

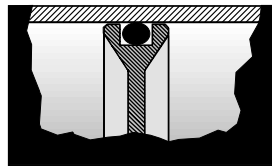

O TYPE PISTON

Dynamic O-ring piston seal (Buna N standard; Viton available only on Series O). Side loading will greatly reduce effectiveness of Series OLF.

O/OLF

Standard Bore Sizes – 1¹/₈, 1¹/₂, 2, 2¹/₂, 3¹/₄, 4
Stock Stroke Sizes – 1" to 18" (1" increments)
Cushions available – either/both ends
Pneumatic – 150 psi maximum
Hydraulic – consult factory

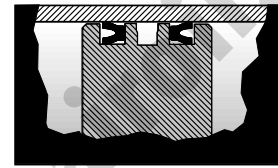

H TYPE PISTON

Pressure energized, wear compensating U-cup piston seals (Buna N standard; Viton available).

H

Standard Bore Sizes – 1¹/₈, 1¹/₂, 2, 2¹/₂, 3¹/₄, 4
Stock Stroke Sizes – 1" to 18" (1" increments)
Cushions available – either/both ends
Pneumatic – 150 psi maximum
Hydraulic – consult factory

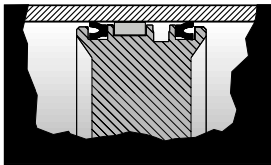

D TYPE PISTON

Pressure energized, wear compensating U-cup piston seals (Buna N standard, Viton available). An acetal wear ring (bearing) prevents metal-to-metal contact when side load conditions are present.

D

Standard Bore Sizes – 1¹/₈, 1¹/₂, 2, 2¹/₂, 3¹/₄, 4
Stock Stroke Sizes – 1" to 18" (1" increments)
Cushions available – either/both ends
Pneumatic – 150 psi maximum
Hydraulic – consult factory

SINGLE-ACTING CYLINDERS

FLAIRLINE HI-CYCLE

SERIES FSR, OSR, HSR AND DSR

The Flairline single-acting cylinder offers the same quality, performance and features as the double-acting model. Actuated by pressurizing only one port, a spring provides the required force to return the piston rod to its normal position. Single actuation conserves energy and can minimize control valve expense. Available with F, O, H or D type pistons. Please specify after series, -E for normally extended or -R for retracted. See page 7 for dimensional data and page 10 for mounting accessories. For special options, see page 16.

For ordering information, see page 18.



	FSR	OSR	HSR	DSR
<i>Standard Bore Sizes</i>	2 to 4	1 ¹ / ₈ to 4	1 ¹ / ₈ to 4	1 ¹ / ₈ to 4
<i>Stock Stroke Sizes (1" increments)</i>	1" to 6"	1" to 6"	1" to 6"	1" to 6"
<i>Cushions available</i>	Normally extended: Head end only Normally retracted: Cap end only			
<i>Pneumatic</i>	150 psi max.	150 psi max.	150 psi max.	150 psi max.
<i>Hydraulic</i>	N/A	consult factory	consult factory	consult factory

DOUBLE-ACTING DOUBLE-ENDED CYLINDERS

FLAIRLINE HI-CYCLE

SERIES FDE, ODE, HDE AND DDE



Flairline double-acting double-ended cylinders feature F, O, H or D type pistons and piston rod extensions from each end. As one end is extended, the opposite end is retracted. Working range (stroke), force and speed are equal in both directions. With both rod ends threaded and a complete line of mounting attachments available, work can be accomplished at both ends of the cylinder simultaneously. See page 7 for dimensional data and page 10 for mounting accessories. For special options, see page 16

For ordering information, see page 18.

	FDE	ODE	HDE	DDE
Standard Bore Sizes	1 ¹ / ₈ to 2 ¹ / ₂	1 ¹ / ₈ to 4	1 ¹ / ₈ to 4	1 ¹ / ₈ to 4
Stock Stroke Sizes (1" increments)	1" to 18"	1" to 18"	1" to 18"	1" to 18"
Cushions available	either/both ends	either/both ends	either/both ends	either/both ends
Pneumatic	150 psi max.	150 psi max.	150 psi max.	150 psi max.
Hydraulic	N/A	consult factory	consult factory	consult factory

TANDEM CYLINDERS

FLAIRLINE HI-CYCLE

SERIES FT AND DT



Tandem models consist of two cylinders joined by a common center section. An H type piston (Series FT) or a D type piston (Series DT) in each cylinder is interconnected to the other by a common piston rod. Operated as two double-acting cylinders, Series FT or DT can be used to multiply force without increasing pressure or bore size. Filling the rod end cylinder with oil and using a flow control between its ports, tandems can provide the accurate speed regulation of a hydraulic cylinder while the cap end unit is operated with economical air. See page 7 for dimensional data and page 10 for mounting accessories. For special options, see page 16.

For ordering information, see page 18.

FT/DT

Standard Bore Sizes – 1¹/₂ to 4
 Stock Stroke Sizes – 1" to 18" (1" increments)
 Cushions available – either/both ends (cushions not standard on center head)
 Pneumatic – 150 psi maximum
 Hydraulic – consult factory

NOTE: Series FT and DT are also available in double-ended models as well as multi-position single and double-ended models. These must be quoted as "specials" on a "per order" basis.

CAP-TO-CAP CYLINDERS

FLAIRLINE HI-CYCLE

SERIES FCC, OCC, HCC, AND DCC



Cap-to-Cap models consist of two F, O, H or D type cylinders joined at the cap end by a common center section. Each unit can be operated independently of the other to accurately attain and repeat three positions when both units are the same stroke and four positions when each unit is a different stroke. See page 7 for dimensional data and page 10 for mounting accessories. For special options, see page 16.

For ordering information, see page 18.

	FCC	OCC	HCC	DCC
Standard Bore Sizes	1 ¹ / ₈ to 4	1 ¹ / ₈ to 4	1 ¹ / ₈ to 4	1 ¹ / ₈ to 4
Stock Stroke Sizes (1" increments)	1" to 18"	1" to 18"	1" to 18"	1" to 18"
Cushions available	either/both ends of both units	either/both ends of both units	either/both ends of both units	either/both ends of both units
Pneumatic	150 psi max.	150 psi max.	150 psi max.	150 psi max.
Hydraulic	N/A	consult factory	consult factory	consult factory

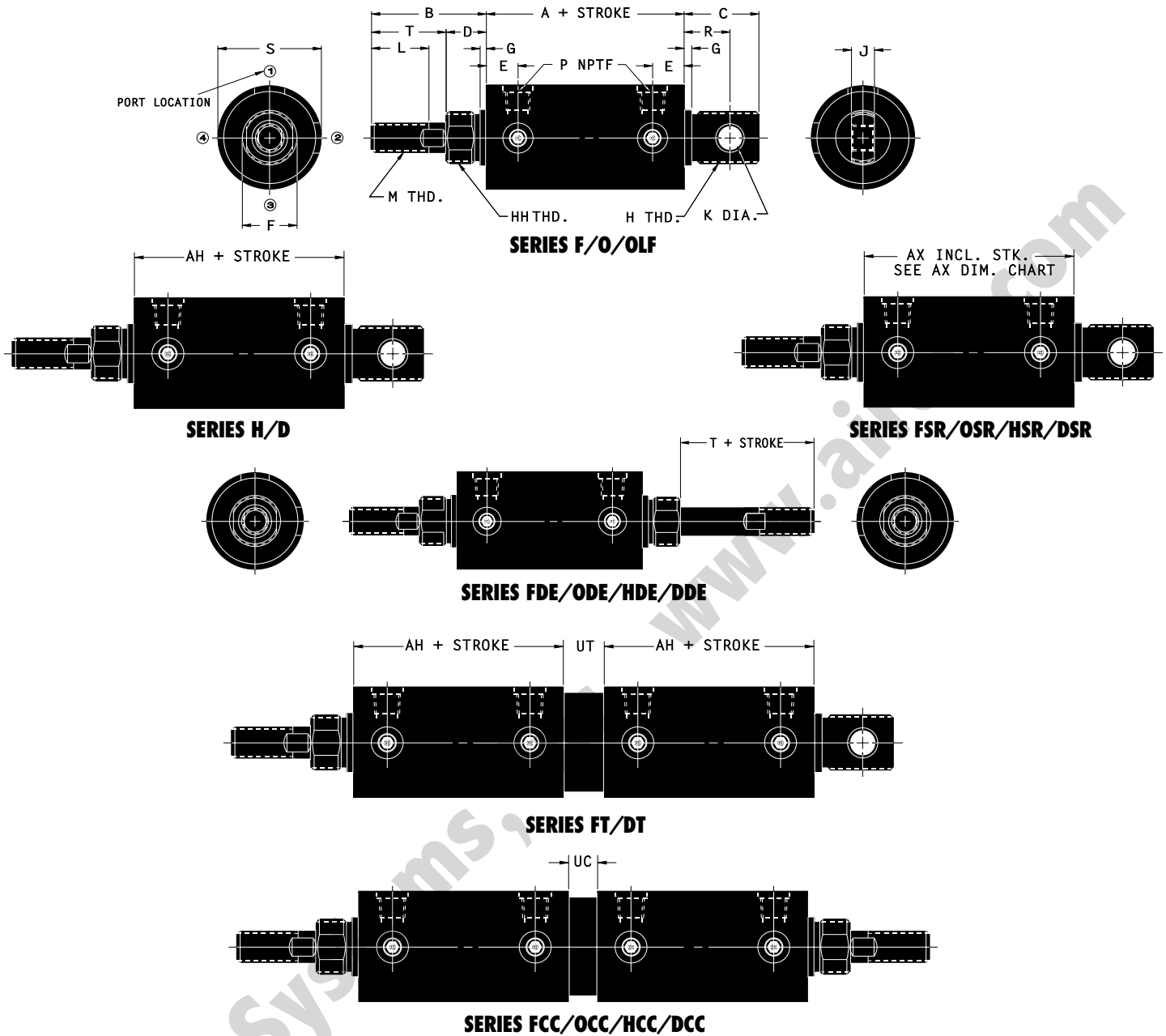

Note: Dimensions not shown remain the same (according to bore size) as on the Series F/O/OLF drawing with the following exceptions: Series HDE, DDE, HCC and DCC use AH dimension in place of A dimension and Series HSR and DSR add 1" to all AX dimensions.

DIMENSION REFERENCE	CYLINDER BORE						DIMENSION REFERENCE	CYLINDER BORE							
	1 1/8	1 1/2	2	2 1/2	3 1/4	4		1 1/8	1 1/2	2	2 1/2	3 1/4	4		
A	2 ²⁵ / ₃₂	3 ⁵ / ₁₆	3 ⁵ / ₁₆	3 ⁵ / ₁₆	4 ¹¹ / ₁₆	4 ¹¹ / ₁₆	R	1 ¹¹ / ₁₆	7/8	1	1	1	1		
B	2 1/8	2 1/2	2 1/2	2 1/2	3 ¹⁹ / ₃₂	3 ¹⁹ / ₃₂	S	1 3/8	1 3/4	2 1/4	2 3/4	3 1/2	4 1/4		
C	1 1/16	1 1/4	1 5/8	1 5/8	1 11/16	1 11/16	T	1 1/2	1 5/8	1 5/8	1 5/8	2 3/8	2 3/8		
D	5/8	7/8	7/8	7/8	1 7/32	1 7/32	AH	3 ²⁵ / ₃₂	4 ⁵ / ₁₆	4 ⁵ / ₁₆	4 ⁵ / ₁₆	5 ¹¹ / ₁₆	5 ¹¹ / ₁₆		
E	1 ⁹ / ₃₂	1 ¹¹ / ₁₆	1 ¹¹ / ₁₆	1 ¹¹ / ₁₆	3 ¹ / ₃₂	3 ¹ / ₃₂	UC	1/2	1/2	1/2	1/2	1 ⁵ / ₁₆	1 ⁵ / ₁₆		
F	1.062	1.187	1.187	1.187	1.687	1.687	UT	-	3/4	3/4	3/4	1 1/8	1 1/8		
G	1/8	5/32	5/32	5/32	5/32	5/32	AX DIMENSION CHART INCLUDING STROKE LENGTHS								
H	1-14	1 1/8-12	1 1/8-12	1 1/8-12	1 5/8-12	1 5/8-12	CYLINDER BORE SIZE	STROKE LENGTHS							
J	1/2	1/2	1/2	1/2	3/4	3/4		1" or Less	Over 1" to 1 1/2"	Over 1 1/2" to 2 1/2"	Over 2 1/2" to 3"	Over 3" to 3 1/2"	Over 3 1/2" to 4 1/2"	Over 4 1/2" to 5 1/2"	Over 5 1/2" to 6"
K	5/16	5/16	7/16	7/16	1/2	1/2	1 1/8	6 ²⁵ / ₃₂	7 ²⁵ / ₃₂	8 ²⁵ / ₃₂	9 ²⁵ / ₃₂	10 ²⁵ / ₃₂	11 ²⁵ / ₃₂	13 ²⁵ / ₃₂	15 ²⁵ / ₃₂
L	1 1/8	1 1/4	1 1/4	1 1/4	1 7/8	1 7/8	1 1/2, 2, 2 1/2	7 ⁵ / ₁₆	8 ⁵ / ₁₆	9 ⁵ / ₁₆	10 ⁵ / ₁₆	11 ⁵ / ₁₆	12 ⁵ / ₁₆	14 ⁵ / ₁₆	16 ⁵ / ₁₆
M*	1/2-20	5/8-18	5/8-18	5/8-18	1-14	1-14	3 1/4, 4	8 ¹¹ / ₁₆	9 ¹¹ / ₁₆	10 ¹¹ / ₁₆	11 ¹¹ / ₁₆	12 ¹¹ / ₁₆	13 ¹¹ / ₁₆	15 ¹¹ / ₁₆	17 ¹¹ / ₁₆
P-NPTF	1/8	1/4	1/4	1/4	1/2	1/2									

*Thread size and rod diameter.

MAGNETIC SWITCH CYLINDERS

FLAIRLINE HI-CYCLE

M, DM AND DIGIT-AIR® M TYPE CYLINDERS



When automated stroke sequencing is important to you, specify Flairline magnetic switch cylinders. Standard construction includes pistons complete with a factory installed magnet which is a composite of nitrile and specifically oriented barium ferrite particles. Flairline magnetic switch cylinders offer the quality features common to other Flairline cylinder products including: hard anodized aluminum barrels, aluminum heads and end caps, chrome-plated rods (stainless steel rods on Digit-Air M type cylinders), nylon rod bearings (bronze rod bearings on DM and Digit-Air M type cylinders) and a complete line of universal mounting accessories. Magnetic Switch options include Reed and Hall Effect types. Stainless steel mounting bands can be adjusted to any location on the cylinder allowing several switches to be mounted for controlling or initiating any sequence function. See pages 9 and 10 for dimensional data and page 10 for mounting accessories. For special options, see page 16.

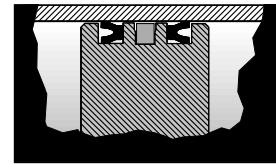

M TYPE PISTON

Pressure energized, wear compensating U-cup piston seals (Buna N standard; Viton available), piston includes magnet.

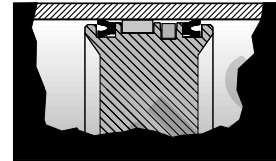

DM TYPE PISTON

Pressure energized, wear compensating U-cup piston seals (Buna N standard), piston includes magnet. An acetal wear ring (bearing) prevents metal-to-metal contact when side load conditions are present.

For ordering information, see page 19.

Other Flairline magnetic switch cylinders include: Series DIM and DIMDE on page 12; Series DSIM and DSIMDE on page 14; and Series OIM and OIMNR on page 22.

SWITCH OPTIONS

FLAIRLINE HI-CYCLE

MAGNETIC SWITCH CYLINDERS

REED SWITCH - PART NO. 43-CR

-Warning-
Do not exceed Ratings.
Permanent damage to sensor may occur.

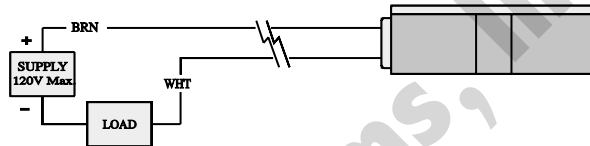

HALL EFFECT SWITCH - SOURCING - PART NO. 43-HP

-Warning-
Do not exceed 24 VDC.
Permanent damage to sensor may occur.



HALL EFFECT SWITCH - SINKING - PART NO. 43-HN

-Warning-
Do not exceed 24 VDC.
Permanent damage to sensor may occur.

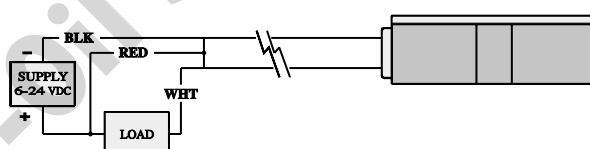

MOUNTING BAND - INCLUDED WITH SWITCHES

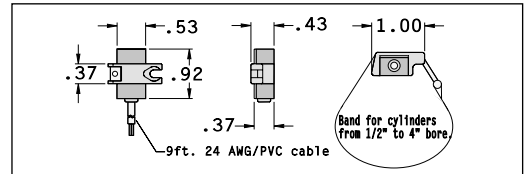

Power Supply Polarity MUST be observed for proper operation.
FAILURE TO OBSERVE POLARITY WILL CAUSE DAMAGE TO SWITCH.

Temperature Range - operational from -30° to +80° C
Shock - operational up to 30G (11msec.)/Reeds only. Not applicable for Halls.
Vibration - operational up to 20G (10-55 Hz)/Reeds only. Not applicable for Halls.

SENSOR TYPES AND TECHNICAL DATA

Part No.	Description	Function	Switching Voltage	Switching Current	Switching Power	Switching Speed	Max Volt. Drop	Sensitivity
43CR	Reed Switch MOV, LED	SPST Normally Open	5-120 VDC/VAC 50/60 Hz	0.5 Amp Max 0.005 Amp Min.	10 Watts Max.	0.5ms operate 0.1ms release	3.5 Volts	85 Gauss
43HP	Half Effect, LED Sourcing	Normally Open PNP output	6 - 24 VDC	0.5 Amp max.	12 Watts Max.	1.5µ operate 0.5µ release	0.5 Volts	85 Gauss
43HN	Half Effect, LED Sinking	Normally Open NPN output	6 - 24 VDC	0.5 Amp max.	12 Watts Max.	1.5µ operate 0.5µ release	0.5 Volts	85 Gauss

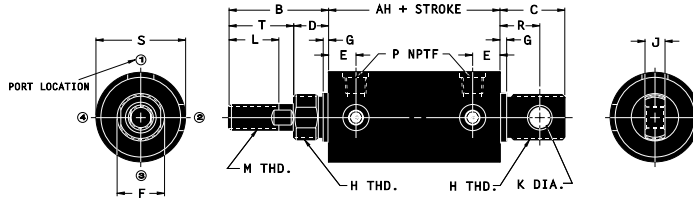

SERIES M/DM Double-acting Cylinders
 Standard Bore Sizes – 1¹/₈, 1¹/₂, 2, 2¹/₂, 3¹/₄, 4
 Stock Stroke Sizes – 1" to 18" (1" increments)
 Cushions available – either/both ends
 Pneumatic – 150 psi maximum
 Hydraulic – consult factory

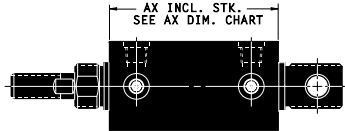

SERIES MSR/DMSR Single-acting Cylinders
 Standard Bore Sizes – 1¹/₈, 1¹/₂, 2, 2¹/₂, 3¹/₄, 4
 Stock Stroke Sizes – 1" to 6" (1" increments)
 Cushions available – Normally extended: Head end only
 Normally retracted: Cap end only
 Pneumatic – 150 psi maximum
 Hydraulic – consult factory
 After Series, specify:

-E for normally extended or
 -R for normally retracted

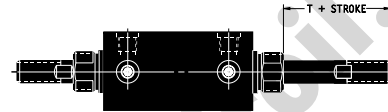

SERIES MDE/DMDE Double-ended Cylinders
 Standard Bore Sizes – 1¹/₈, 1¹/₂, 2, 2¹/₂, 3¹/₄, 4
 Stock Stroke Sizes – 1" to 18" (1" increments)
 Cushions available – either/both ends
 Pneumatic – 150 psi maximum
 Hydraulic – consult factory

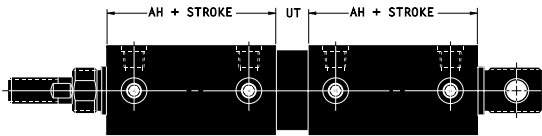

SERIES MT/DMT Tandem Cylinders
 Standard Bore Sizes – 1¹/₂, 2, 2¹/₂, 3¹/₄, 4
 Stock Stroke Sizes – 1" to 18" (1" increments)
 Cushions available – either/both ends (cushions not standard on center head)
 Pneumatic – 150 psi maximum
 Hydraulic – consult factory

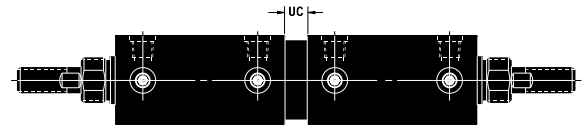

SERIES MCC/DMCC Cap-to-Cap Cylinders
 Standard Bore Sizes – 1¹/₈, 1¹/₂, 2, 2¹/₂, 3¹/₄, 4
 Stock Stroke Sizes – 1" to 18" (1" increments)
 Cushions available – either/both ends of both units
 Pneumatic – 150 psi maximum
 Hydraulic – consult factory

NOTE: Dimensions that do not appear remain the same (according to bore size) as on the Series M/DM drawing.

Series MT/DMT are also available in double-ended models as well as multi-position single and double-ended models. These must be quoted as "specials" on a "per order" basis.

DIMENSION REFERENCE	CYLINDER BORE						DIMENSION REFERENCE	CYLINDER BORE							
	1 ¹ / ₈	1 ¹ / ₂	2	2 ¹ / ₂	3 ¹ / ₄	4		1 ¹ / ₈	1 ¹ / ₂	2	2 ¹ / ₂	3 ¹ / ₄	4		
AH	3 ²⁵ / ₃₂	4 ⁵ / ₁₆	4 ⁵ / ₁₆	4 ⁵ / ₁₆	5 ¹¹ / ₁₆	5 ¹¹ / ₁₆	R	1 ¹¹ / ₁₆	7 ⁷ / ₈	1	1	1	1		
B	2 ¹ / ₈	2 ¹ / ₂	2 ¹ / ₂	2 ¹ / ₂	3 ¹⁹ / ₃₂	3 ¹⁹ / ₃₂	S	1 ³ / ₈	1 ³ / ₄	2 ¹ / ₄	2 ³ / ₄	3 ¹ / ₂	4 ¹ / ₄		
C	1 ¹ / ₁₆	1 ¹ / ₄	1 ⁵ / ₈	1 ⁵ / ₈	1 ¹¹ / ₁₆	1 ¹¹ / ₁₆	T	1 ¹ / ₂	1 ⁵ / ₈	1 ⁵ / ₈	1 ⁵ / ₈	2 ³ / ₈	2 ³ / ₈		
D	5 ⁵ / ₈	7 ⁷ / ₈	7 ⁷ / ₈	7 ⁷ / ₈	1 ⁷ / ₃₂	1 ⁷ / ₃₂	UC	1 ¹ / ₂	1 ¹ / ₂	1 ¹ / ₂	1 ¹ / ₂	1 ¹⁵ / ₁₆	1 ¹⁵ / ₁₆		
E	1 ¹⁹ / ₃₂	1 ¹¹ / ₁₆	1 ¹¹ / ₁₆	1 ¹¹ / ₁₆	3 ³¹ / ₃₂	3 ³¹ / ₃₂	UT	-	3 ³ / ₄	3 ³ / ₄	3 ³ / ₄	1 ¹ / ₈	1 ¹ / ₈		
F	1.062	1.187	1.187	1.187	1.687	1.687	AX DIMENSION CHART INCLUDING STROKE LENGTHS								
G	1 ¹ / ₈	5 ⁵ / ₃₂	5 ⁵ / ₃₂	5 ⁵ / ₃₂	5 ⁵ / ₃₂	5 ⁵ / ₃₂									
H	1-14	1 ¹ / ₈ -12	1 ¹ / ₈ -12	1 ¹ / ₈ -12	1 ⁵ / ₈ -12	1 ⁵ / ₈ -12	CYLINDER BORE SIZE	STROKE LENGTHS							
J	1 ¹ / ₂	1 ¹ / ₂	1 ¹ / ₂	1 ¹ / ₂	3 ³ / ₄	3 ³ / ₄		1" or Less	Over 1" to 1 ¹ / ₂ "	Over 1 ¹ / ₂ " to 2 ¹ / ₂ "	Over 2 ¹ / ₂ " to 3"	Over 3" to 3 ¹ / ₂ "	Over 3 ¹ / ₂ " to 4 ¹ / ₂ "	Over 4 ¹ / ₂ " to 5 ¹ / ₂ "	Over 5 ¹ / ₂ " to 6"
K	5 ⁵ / ₁₆	5 ⁵ / ₁₆	7 ⁷ / ₁₆	7 ⁷ / ₁₆	1 ¹ / ₂	1 ¹ / ₂	1 ¹ / ₈	7 ²⁵ / ₃₂	8 ²⁵ / ₃₂	9 ²⁵ / ₃₂	10 ²⁵ / ₃₂	11 ²⁵ / ₃₂	12 ²⁵ / ₃₂	14 ²⁵ / ₃₂	16 ²⁵ / ₃₂
L	1 ¹ / ₈	1 ¹ / ₄	1 ¹ / ₄	1 ¹ / ₄	1 ⁷ / ₈	1 ⁷ / ₈	1 ¹ / ₂ , 2, 2 ¹ / ₂	8 ⁸ / ₁₆	9 ⁹ / ₁₆	10 ¹⁰ / ₁₆	11 ¹¹ / ₁₆	12 ¹² / ₁₆	13 ¹³ / ₁₆	15 ¹⁵ / ₁₆	17 ¹⁷ / ₁₆
M*	1 ¹ / ₂ -20	5 ⁵ / ₈ -18	5 ⁵ / ₈ -18	5 ⁵ / ₈ -18	1-14	1-14	1 ¹ / ₂ , 2, 2 ¹ / ₂	8 ⁸ / ₁₆	9 ⁹ / ₁₆	10 ¹⁰ / ₁₆	11 ¹¹ / ₁₆	12 ¹² / ₁₆	13 ¹³ / ₁₆	15 ¹⁵ / ₁₆	17 ¹⁷ / ₁₆
P-NPTF	1 ¹ / ₈	1 ¹ / ₄	1 ¹ / ₄	1 ¹ / ₄	1 ¹ / ₂	1 ¹ / ₂	3 ³ / ₄ , 4	9 ⁹ / ₁₆	10 ¹⁰ / ₁₆	11 ¹¹ / ₁₆	12 ¹² / ₁₆	13 ¹³ / ₁₆	14 ¹⁴ / ₁₆	16 ¹⁶ / ₁₆	18 ¹⁸ / ₁₆

*Thread size and rod diameter.

See page 10 for mounting accessories, page 16 for special options and page 19 for ordering information.

DIMENSIONAL DATA

FLAIRLINE HI-CYCLE

DIGIT-AIR® M TYPE CYLINDERS

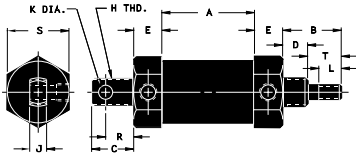

FOR SERIES MTM & MSM DOUBLE ACTING: A + STROKE
 FOR SERIES MTMR & MSMR SPRING RETURN: A + (STROKE X 2)
 FOR SERIES MTMR & MSMR UP TO 1/2" STROKE SPRING RETURN: A + (STROKE + 1")

SERIES MTM/MTMR SWIVEL MOUNT CYLINDERS

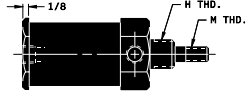

SERIES MSM/MSMR NOSE MOUNT CYLINDERS

	MTM/MSM	MTMR/MSMR
Standard Bore Sizes	1/2, 3/4, 1 1/8	1/2, 3/4, 1 1/8
Stock Stroke Sizes (1/2" increments)	See below	See below
Bumpers available	Either/both ends	Normally extended: head end only Normally retracted: cap end only
Pneumatic	200 psi max.	200 psi max.
Hydraulic	200 psi max.	200 psi max.
After Series, specify:		-E for normally extended or -R for normally retracted

Bore Size	A	B	C	D	E	H	J	K	L	M	R	S	T
1/2	2 1/16	1 1/4	13/16	1/2	9/16	1/2-20	1/4	1/4	1/2	1/4-28	9/16	3/4	3/4
3/4	1 9/16	1 1/4	13/16	1/2	9/16	5/8-18	1/4	1/4	1/2	1/4-28	9/16	1	3/4
1 1/8	1 9/16	1 5/16	15/16	9/16	5/8	5/8-18	3/8	5/16	1/2	5/16-24	5/8	1 3/8	3/4

Porting for all sizes is 1/8" N.P.T.F.

NOTE: For cylinders with bumpers, contact factory for stock stroke sizes and add 1/2" to Dimension "A" for each bumper. For cylinders with switches, contact factory for number of switches each stock stroke size can accommodate.

See page 8 for magnetic switch options, page 15 for mounting accessories, page 16 for special options and page 19 for ordering information.

MOUNTING ACCESSORIES

FLAIRLINE HI-CYCLE

F, O, H, D, M AND DM TYPE CYLINDERS

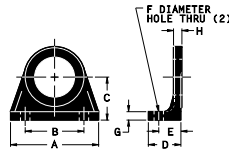

FOOT BRACKET

Bore Size	Number	DIMENSIONS							
		A	B	C	D	E	F	G	H
1 1/8	1-32-225	2 7/8	1 7/8	1 7/32	1	11/16	9/32	9/16	1/4
1 1/2	1-32-3	2 7/8	1 7/8	1 7/32	1	11/16	9/32	1/4	1/4
2, 2 1/2	1-32-4	3 1/4	2 1/4	1 19/32	1 1/32	11/16	11/32	1/4	1/4
3 1/4, 4	1-32-65	5 1/2	4	2 1/2	1 23/32	1 1/32	11/32	1/2	1/2

Mounting nut included.

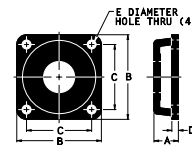

FLANGE BRACKET

Bore Size	Number	DIMENSIONS				
		A	B	C	D	E
1 1/8	1-33-225	11/16	2 1/2	2	1/4	9/32
1 1/2, 2, 2 1/2	1-33-4	11/16	3 1/4	2 1/2	1/4	11/32
3 1/4, 4	1-33-65	1 7/32	5 1/4	4	1/2	11/32

Mounting nut included.

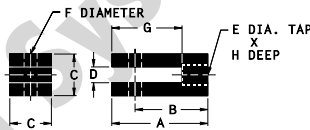

ROD CLEVIS

Bore Size	Number	DIMENSIONS							
		A	B	C	D	E	F	G	H
1 1/8	1-35-225	2 7/16	1 7/8	1	3/8	1/2-20	7/16	1 11/16	11/16
1 1/2, 2, 2 1/2	1-35-3	2 7/8	1 7/8	1	17/32	7/8-18	7/16	1 11/16	11/16
3 1/4, 4	1-35-65	3 3/8	2 7/8	1 1/2	1-14	1/2	1 7/16	1 1/4	1 1/4

Connecting Pin included.



MOUNTING NUT

Bore Size	Number	DIMENSIONS	
		Height	Across Flats
1 1/8	1-38-16	11/32	1 1/8
1 1/2, 2, 2 1/2	1-38-20	11/32	1 1/4
3 1/4, 4	1-38-28	11/16	2 1/8

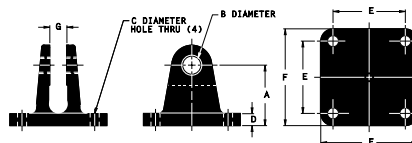

SWIVEL BRACKET

Bore Size	Number	DIMENSIONS						
		A	B	C	D	E	F	G
1 1/8, 1 1/2	1-34-3	1 1/4	2 1/16	7/32	7/16	1 7/8	2 1/4	17/32
2, 2 1/2	1-34-4	1 7/8	2 1/16	11/32	3/4	2 1/4	3	17/32
3 1/4, 4	1-34-65	2 7/8	1 1/2	11/32	1/2	3	4	17/32

Connecting pin included.

ROD NUT INCLUDED ON ALL F, O, H, D, M AND DM TYPE CYLINDERS



I type cylinders include Series I double-acting cylinders and Series IDE double-ended cylinders which are dimensionally interchangeable with some competitive cylinders. External dimensions may be interchanged with competitors to minimize expensive inventory or engineering changeovers. Operating systems can be pneumatic or hydraulic. **Standard Series I and IDE cylinders can also provide low friction pneumatic service for use in low pressure applications and where low minimum breakaway is required.** Standard construction includes O-ring pistons and many other features common to Flairline cylinder products including: hard anodized aluminum barrels, aluminum heads and end caps, chrome-plated rods, nylon rod bearings, rod wipers and a complete line of universal mounting accessories. For special options, see page 16.

For ordering information, see page 18.

Standard Bore Sizes – 1¹/₈, 1¹/₂, 2, 2¹/₂, 3
 Stock Stroke Sizes – 1" to 18" (1" increments)
 Cushions available – either/both ends
 Pneumatic – 150 psi maximum
 Hydraulic – consult factory

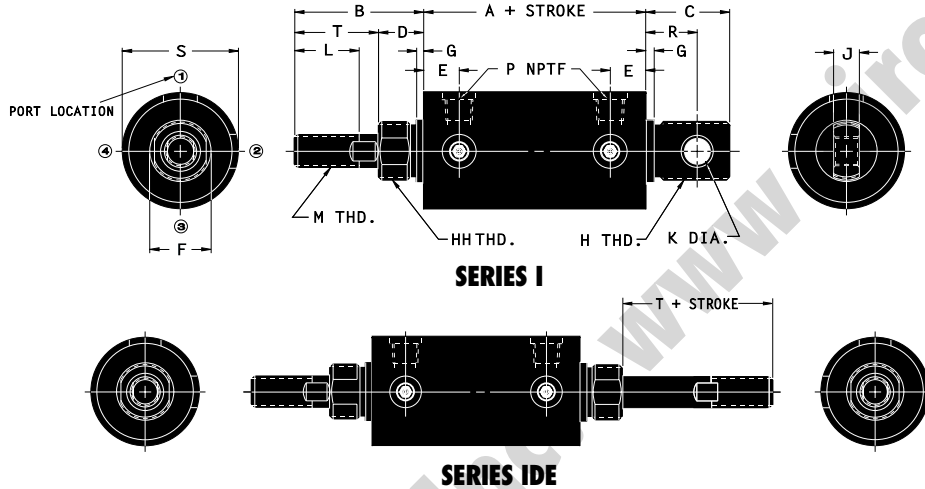

DIMENSIONAL DATA

Bore Size	A	B	C	D	E	F	G	H	J	K	L	M*	P	R	S	T
1 ¹ / ₈	2 ¹ / ₃₂	1 ³ / ₄	3 ¹ / ₃₂	3/4	27/64	3/4	1/8	3/4-16	3/8	1/4	7/8	3/8-16	1/8	11/16	1 ³ / ₈	1
1 ¹ / ₂	2 ⁵ / ₈	2 ⁷ / ₁₆	1 ¹ / ₄	1	33/64	1 ¹ / ₁₆	7/32	1 ¹ / ₁₆ -18	1/2	5/16	1 ¹ / ₄	1/2-13	1/4	7/8	1 ³ / ₄	1 ⁷ / ₁₆
2	2 ⁵ / ₈	2 ⁷ / ₁₆	1 ¹ / ₄	1	33/64	1 ¹ / ₁₆	7/32	1 ¹ / ₁₆ -18	1/2	5/16	1 ¹ / ₄	5/8-11	1/4	7/8	2 ¹ / ₄	1 ⁷ / ₁₆
2 ¹ / ₂	2 ⁷ / ₈	2 ¹⁵ / ₁₆	2	1 ¹ / ₄	9/16	1 ⁷ / ₁₆	11/32	1 ³ / ₈ -12	5/8	7/16	1 ¹ / ₂	3/4-10	3/8	1 ³ / ₈	2 ³ / ₄	1 ¹¹ / ₁₆
3	2 ⁷ / ₈	2 ¹⁵ / ₁₆	2	1 ¹ / ₄	9/16	1 ⁷ / ₁₆	11/32	1 ³ / ₈ -12	5/8	7/16	1 ¹ / ₂	3/4-10	3/8	1 ³ / ₈	3 ¹ / ₄	1 ¹¹ / ₁₆

*Thread size and rod diameter

MOUNTING ACCESSORIES

ROD CLEVIS

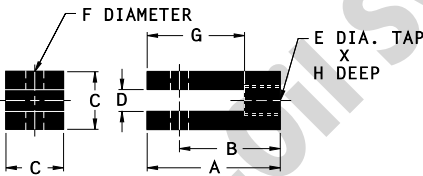

Bore Size	Number	DIMENSIONS							
		A	B	C	D	E	F	G	H
1 ¹ / ₈	2-35-225	1 ³ / ₄	1 ¹³ / ₃₂	3/4	5/16	3/8-16	1/4	1	3/4
1 ¹ / ₂	2-35-3	2 ¹ / ₄	1 ³ / ₄	1	3/8	1 ¹ / ₂ -13	5/16	1 ³ / ₁₆	1 ¹ / ₁₆
2	2-35-4	2 ¹ / ₄	1 ³ / ₄	1	3/8	5/8-11	5/16	1 ³ / ₁₆	1 ¹ / ₁₆
2 ¹ / ₂ , 3	2-35-6	2 ¹¹ / ₁₆	2 ¹ / ₁₆	1 ¹ / ₈	1/2	3/4-10	7/16	1 ³ / ₄	1 ³ / ₁₆

Connecting pin included.

MOUNTING NUT



Bore Size	Number	DIMENSIONS	
		Height	Across Flats
1 ¹ / ₈	2-38-12	3/8	1 ¹ / ₁₆
1 ¹ / ₂ , 2	2-38-18	15/32	1 ⁷ / ₁₆
2 ¹ / ₂ , 3	2-38-24	25/32	2 ¹ / ₁₆

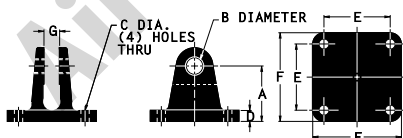

SWIVEL BRACKET

Bore Size	Number	DIMENSIONS						
		A	B	C	D	E	F	G
1 ¹ / ₈	2-34-225	1 ⁷ / ₃₂	1/4	9/32	5/16	1 ³ / ₄	2 ¹ / ₄	3/8
1 ¹ / ₂ , 2	2-34-4	1 ³ / ₄	5/16	9/32	5/16	2 ¹ / ₄	3	1/2
2 ¹ / ₂ , 3	2-34-6	2 ³ / ₈	7/16	13/32	3/8	3	4	5/8

Connecting pin included.

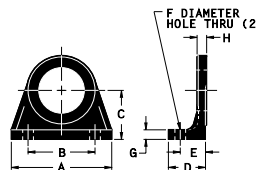

FOOT BRACKET

Bore Size	Number	DIMENSIONS							
		A	B	C	D	E	F	G	H
1 ¹ / ₈	2-32-225	1 ⁵ / ₈	1	1 ⁹ / ₃₂	1	5/8	17/64	1/4	1/4
1 ¹ / ₂ , 2	2-32-4	3	1 ¹ / ₁₆	1 ¹ / ₂	1 ¹⁷ / ₃₂	57/64	9/32	5/16	5/16
2 ¹ / ₂ , 3	2-32-6	4	2 ¹ / ₄	2	2 ³ / ₃₂	1 ⁷ / ₃₂	13/32	3/8	3/8

Mounting nut included.

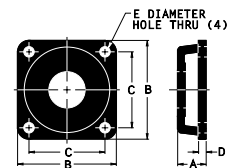

FLANGE BRACKET

Bore Size	Number	DIMENSIONS				
		A	B	C	D	E
1 ¹ / ₈	2-33-225	11/16	2 ¹ / ₂	2	1/4	9/32
1 ¹ / ₂ , 2	2-33-4	19/32	3 ¹ / ₄	2 ¹ / ₂	5/16	9/32
2 ¹ / ₂ , 3	2-33-6	23/32	4 ¹ / ₂	3 ³ / ₈	3/8	13/32

Mounting nut included.

ROD NUT INCLUDED ON ALL I AND DI TYPE CYLINDERS



DI type cylinders expand Flairline's I type cylinders by offering double U-cup pistons with wear strips and bronze rod bearings for use when side load conditions are present. External dimensions may be interchanged with competitors to minimize expensive inventory or engineering changeovers.

DI type cylinders include four series:

Series DI double-acting cylinders and Series DIDE double-ended cylinders provide pneumatic or hydraulic service. **Standard Series DI and DIDE cylinders also offer low friction pneumatic service for use in low pressure applications and where low minimum breakaway is required.**

Series DIM double-acting cylinders and Series DIMDE double-ended cylinders provide pneumatic or hydraulic service and include pistons with factory installed magnets for use with magnetic switches. For automated stroke sequencing, specify Series DIM or DIMDE. See page 8 for magnetic switch options.

See page 11 for mounting accessories and page 16 for special options.

For ordering information, see pages 18 and 19.

Standard Bore Sizes – 1¹/₈, 1¹/₂, 2, 2¹/₂, 3

Stock Stroke Sizes – 1" to 18" (1" increments)

Cushions available – either/both ends

Pneumatic – 150 psi maximum

Hydraulic – consult factory

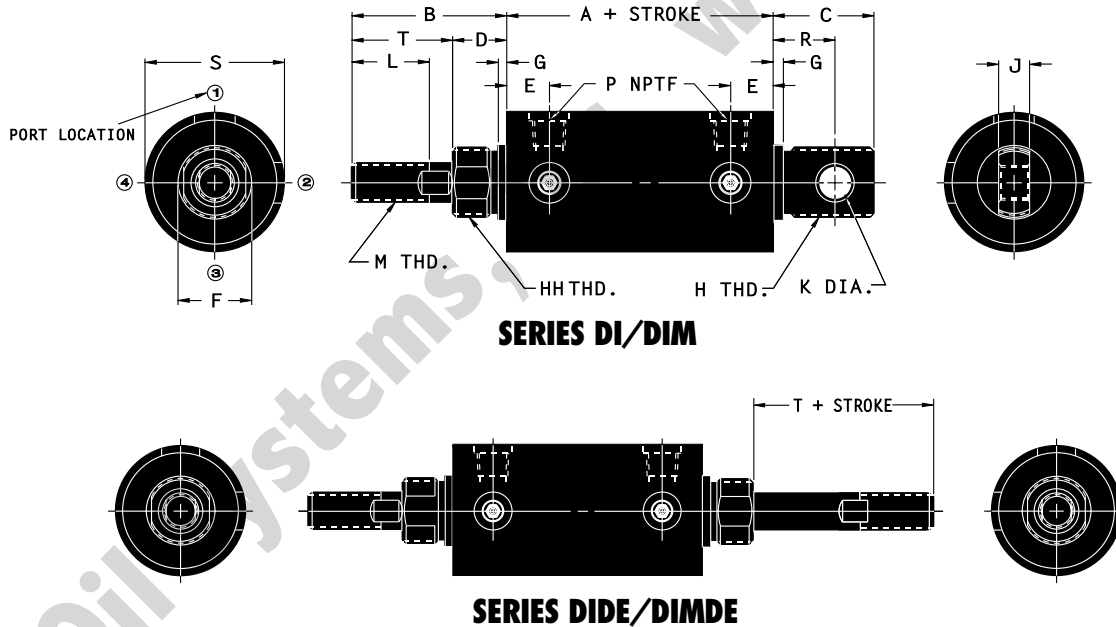

Note: Dimensions that do not appear remain the same (according to bore size) as on the Series DI/DIM drawing.

DIMENSIONAL DATA

Bore Size	A	B	C	D	E	F	G	H	J	K	L	M*	P	R	S	T
1 ¹ / ₈	3 ¹ / ₃₂	1 ³ / ₄	3 ¹ / ₃₂	3 ³ / ₄	27 ¹ / ₆₄	3 ³ / ₄	1 ¹ / ₈	3 ³ / ₄ -16	3 ³ / ₈	1 ¹ / ₄	7 ¹ / ₈	3 ³ / ₈ -16	1 ¹ / ₈	1 ¹¹ / ₁₆	1 ³ / ₈	1
1 ¹ / ₂	3 ⁵ / ₈	2 ⁷ / ₁₆	1 ¹ / ₄	1	33 ¹ / ₆₄	1 ¹ / ₁₆	7 ¹ / ₃₂	1 ¹ / ₁₆ -18	1 ¹ / ₂	5 ¹ / ₁₆	1 ¹ / ₄	1 ¹ / ₂ -13	1 ¹ / ₄	7 ¹ / ₈	1 ³ / ₄	1 ⁷ / ₁₆
2	3 ⁵ / ₈	2 ⁷ / ₁₆	1 ¹ / ₄	1	33 ¹ / ₆₄	1 ¹ / ₁₆	7 ¹ / ₃₂	1 ¹ / ₁₆ -18	1 ¹ / ₂	5 ¹ / ₁₆	1 ¹ / ₄	5 ¹ / ₈ -11	1 ¹ / ₄	7 ¹ / ₈	2 ¹ / ₄	1 ⁷ / ₁₆
2 ¹ / ₂	3 ⁷ / ₈	2 ¹⁵ / ₁₆	2	1 ¹ / ₄	9 ¹ / ₁₆	1 ⁷ / ₁₆	1 ¹¹ / ₃₂	1 ³ / ₈ -12	5 ¹ / ₈	7 ¹ / ₁₆	1 ¹ / ₂	3 ³ / ₄ -10	3 ³ / ₈	1 ³ / ₈	2 ³ / ₄	1 ¹¹ / ₁₆
3	3 ⁷ / ₈	2 ¹⁵ / ₁₆	2	1 ¹ / ₄	9 ¹ / ₁₆	1 ⁷ / ₁₆	1 ¹¹ / ₃₂	1 ³ / ₈ -12	5 ¹ / ₈	7 ¹ / ₁₆	1 ¹ / ₂	3 ³ / ₄ -10	3 ³ / ₈	1 ³ / ₈	3 ¹ / ₄	1 ¹¹ / ₁₆

*Thread size and rod diameter

INTERCHANGE SERIES

FLAIRLINE HI-CYCLE SI TYPE CYLINDERS

SI type cylinders are dimensionally interchangeable with some competitive cylinders. Often, those competitive cylinders not interchangeable with Flairline I type cylinders will be interchangeable with SI type cylinders. Expensive engineering or inventory changeovers may be minimized by the interchangeability of external dimensions. SI type cylinders include Series SI double-acting cylinders and Series SIDE double-ended cylinders. Operating systems can be pneumatic or hydraulic. Standard construction includes O-ring pistons and many other features common to Flairline cylinder products including: hard anodized aluminum barrels, aluminum heads and end caps, chrome-plated rods, nylon rod bearings, rod wipers and a complete line of universal mounting accessories. For special options, see page 16.



Standard Bore Sizes – 1¹/₈, 1¹/₂, 2, 2¹/₂, 3
 Stock Stroke Sizes – 1" to 18" (1" increments)
 Cushions available – either/both ends
 Pneumatic – 150 psi maximum
 Hydraulic – consult factory

For ordering information, see page 18.

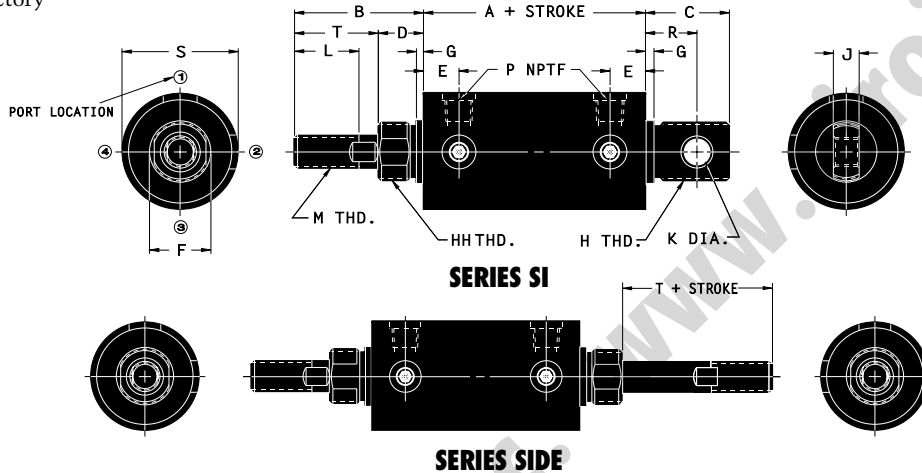

DIMENSIONAL DATA

Bore Size	A	B	C	D	E	F	G	H	HH	J	K	L	M*	P	R	S	T
1 ¹ / ₈	2 ¹ / ₁₆	1 ⁵ / ₈	1	5/8	27/64	3/4	1/8	3/4-16	3/4-16	3/8	1/4	7/8	3/8-16	1/8	11/16	1 ³ / ₈	1
1 ¹ / ₂	2 ⁵ / ₈	2 ⁵ / ₁₆	1 ¹ / ₄	7/8	33/64	1 ¹ / ₁₆	7/32	1 ¹ / ₁₆ -18	1-14	1/2	5/16	1 ¹ / ₄	1/2-13	1/4	7/8	1 ³ / ₄	1 ⁷ / ₁₆
2	2 ⁵ / ₈	2 ⁵ / ₁₆	1 ¹ / ₄	7/8	33/64	1 ¹ / ₁₆	7/32	1 ¹ / ₁₆ -18	1-14	1/2	5/16	1 ¹ / ₄	5/8-11	1/4	7/8	2 ¹ / ₄	1 ⁷ / ₁₆
2 ¹ / ₂	2 ⁷ / ₈	2 ¹¹ / ₁₆	2	1	9/16	1 ³ / ₈	11/32	1 ³ / ₈ -12	1 ³ / ₈ -12	5/8	7/16	1 ¹ / ₂	3/4-10	3/8	1 ³ / ₈	2 ³ / ₄	1 ¹¹ / ₁₆
3	2 ⁷ / ₈	2 ¹¹ / ₁₆	2	1	9/16	1 ³ / ₈	11/32	1 ³ / ₈ -12	1 ³ / ₈ -12	5/8	7/16	1 ¹ / ₂	3/4-10	3/8	1 ³ / ₈	3 ¹ / ₄	1 ¹¹ / ₁₆

*Thread size and Rod diameter.

MOUNTING ACCESSORIES

ROD CLEVIS

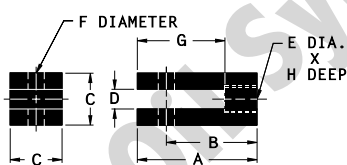

Bore Size	Number	DIMENSIONS							
		A	B	C	D	E	F	G	H
1 ¹ / ₈	2-35-225	1 ³ / ₄	1 ¹³ / ₃₂	2/4	5/16	3/16	1/2	1	3/4
1 ¹ / ₂	2-35-3	2 ¹ / ₄	1 ³ / ₄	1	3/8	1/2-13	5/16	1 ¹ / ₁₆	1 ¹ / ₁₆
2	2-35-4	2 ¹ / ₄	1 ³ / ₄	1	3/8	5/8-11	5/16	1 ¹ / ₁₆	1 ¹ / ₁₆
2 ¹ / ₂ , 3	2-35-6	2 ¹¹ / ₁₆	2 ¹ / ₁₆	1 ¹ / ₈	1/2	1/2-10	7/16	1 ¹ / ₄	1 ¹ / ₁₆

Connecting pin included.

MOUNTING NUT

Bore Size	Number	DIMENSIONS	
		Height	Across Flats
1 ¹ / ₈	2-38-12	3/8	1 ¹ / ₁₆
1 ¹ / ₂ , 2 CAP END (H Dimension)	2-38-18	15/32	1 ⁷ / ₁₆
1 ¹ / ₂ , 2 HEAD (HH Dimension)	1-38-16	11/32	1 ³ / ₈
2 ¹ / ₂ , 3	2-38-24	25/32	2 ¹ / ₁₆

SWIVEL BRACKET

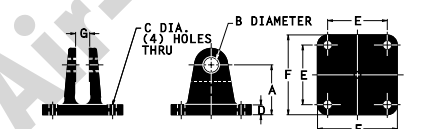

Bore Size	Number	DIMENSIONS						
		A	B	C	D	E	F	G
1 ¹ / ₈	2-34-225	1 ¹ / ₃₂	1/4	9/32	5/16	1 ¹ / ₄	2 ¹ / ₄	3/8
1 ¹ / ₂ , 2	2-34-4	1 ³ / ₄	5/16	9/32	5/16	2 ¹ / ₄	3	1/2
2 ¹ / ₂ , 3	2-34-6	2 ⁷ / ₈	7/16	13/32	3/8	3	4	5/8

Connecting pin included.

FOOT BRACKET

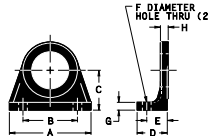

Bore Size	Number	DIMENSIONS							
		A	B	C	D	E	F	G	H
1 ¹ / ₈	2-32-225	1 ⁵ / ₈	1	1 ⁷ / ₃₂	1	5/8	17/64	1/4	1/4
1 ¹ / ₂ , 2 CAP END	2-32-4	3	1 ¹¹ / ₁₆	1 ¹ / ₂	1 ¹⁷ / ₃₂	57/64	9/32	5/16	5/16
1 ¹ / ₂ , 2 HEAD END	2-32-4A	3	1 ¹¹ / ₁₆	1 ¹ / ₂	1 ¹⁷ / ₃₂	57/64	9/32	5/16	5/16
2 ¹ / ₂ , 3	2-32-6	4	2 ¹ / ₄	2	2 ³ / ₃₂	1 ¹⁷ / ₃₂	13/32	3/8	3/8

Mounting nut included.

FLANGE BRACKET

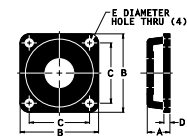

Bore Size	Number	DIMENSIONS				
		A	B	C	D	E
1 ¹ / ₈	2-33-225	1 ¹ / ₁₆	2 ¹ / ₂	2	1/4	9/32
1 ¹ / ₂ , 2 CAP END	2-33-4	19/32	3 ¹ / ₄	2 ¹ / ₂	5/16	9/32
1 ¹ / ₂ , 2 HEAD END	2-33-4A	19/32	3 ¹ / ₄	2 ¹ / ₂	5/16	9/32
2 ¹ / ₂ , 3	2-33-6	25/32	4 ¹ / ₂	3 ³ / ₈	3/8	13/32

Mounting nut included.

ROD NUT INCLUDED ON ALL SI AND DSI TYPE CYLINDERS



DSI type cylinders expand Flairline's SI type cylinders by offering double U-cup pistons with wear strips and bronze rod bearings for use when side load conditions are present. External dimensions may be interchanged with competitors to minimize expensive inventory or engineering changeovers.

DSI type cylinders include four series:

Series DSI double-acting cylinders and Series DSIDE double-ended cylinders provide pneumatic or hydraulic service.

Series DSIM double-acting cylinders and Series DSIMDE double-ended cylinders provide pneumatic or hydraulic service and include pistons with factory installed magnets for use with magnetic switches. For automated stroke sequencing, specify Series DSIM or DSIMDE. See page 8 for magnetic switch options.

See page 13 for mounting accessories and page 16 for special options.

For ordering information, see pages 18 and 19.

Standard Bore Sizes – 1¹/₈, 1¹/₂, 2, 2¹/₂, 3
 Stock Stroke Sizes – 1" to 18" (1" increments)
 Cushions available – either/both ends
 Pneumatic – 150 psi maximum
 Hydraulic – consult factory

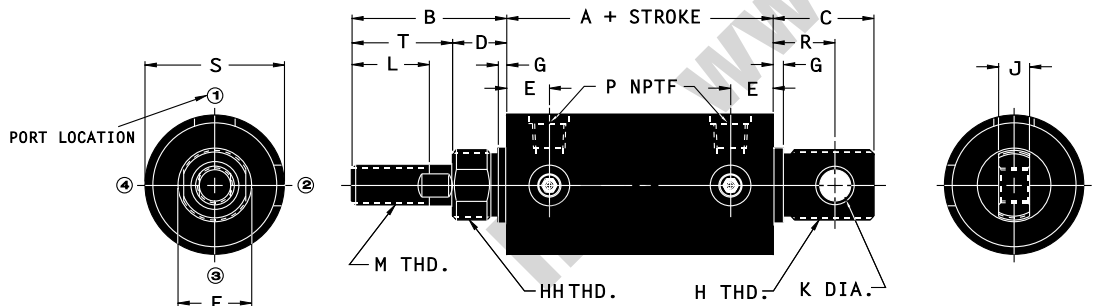

SERIES DSI/DSIM

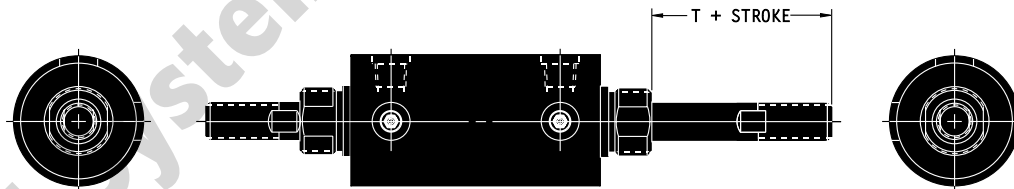

SERIES DSIDE/DSIMDE

Note: Dimensions that do not appear remain the same (according to bore size) as on the Series DSI drawing.

DIMENSIONAL DATA

Bore Size	A	B	C	D	E	F	G	H	HH	J	K	L	M*	P	R	S	T
1 ¹ / ₈	3 ¹ / ₁₆	1 ⁵ / ₈	1	5 ⁵ / ₈	27 ⁵ / ₆₄	3 ³ / ₄	1 ¹ / ₈	3 ³ / ₄ -16	3 ³ / ₄ -16	3 ³ / ₈	1 ¹ / ₄	7 ⁷ / ₈	3 ³ / ₈ -16	1 ¹ / ₈	11 ¹¹ / ₁₆	1 ³ / ₈	1
1 ¹ / ₂	3 ⁵ / ₈	2 ⁵ / ₁₆	1 ¹ / ₄	7 ⁷ / ₈	33 ³³ / ₆₄	1 ¹ / ₁₆	7 ⁷ / ₃₂	1 ¹ / ₁₆ -18	1-14	1 ¹ / ₂	5 ⁵ / ₁₆	1 ¹ / ₄	1 ¹ / ₂ -13	1 ¹ / ₄	7 ⁷ / ₈	1 ³ / ₄	1 ⁷ / ₁₆
2	3 ⁵ / ₈	2 ⁵ / ₁₆	1 ¹ / ₄	7 ⁷ / ₈	33 ³³ / ₆₄	1 ¹ / ₁₆	7 ⁷ / ₃₂	1 ¹ / ₁₆ -18	1-14	1 ¹ / ₂	5 ⁵ / ₁₆	1 ¹ / ₄	5 ⁵ / ₈ -11	1 ¹ / ₄	7 ⁷ / ₈	2 ¹ / ₄	1 ⁷ / ₁₆
2 ¹ / ₂	3 ⁷ / ₈	2 ¹¹ / ₁₆	2	1	9 ⁹ / ₁₆	1 ³ / ₈	11 ¹¹ / ₃₂	1 ³ / ₈ -12	1 ³ / ₈ -12	5 ⁵ / ₈	7 ⁷ / ₁₆	1 ¹ / ₂	3 ³ / ₄ -10	3 ³ / ₈	1 ³ / ₈	2 ³ / ₄	1 ¹¹ / ₁₆
3	3 ⁷ / ₈	2 ¹¹ / ₁₆	2	1	9 ⁹ / ₁₆	1 ³ / ₈	11 ¹¹ / ₃₂	1 ³ / ₈ -12	1 ³ / ₈ -12	5 ⁵ / ₈	7 ⁷ / ₁₆	1 ¹ / ₂	3 ³ / ₄ -10	3 ³ / ₈	1 ³ / ₈	3 ³ / ₄	1 ¹¹ / ₁₆

*Thread size and rod diameter



Flairline Digit-Air double-acting cylinders are inexpensive, repairable, small bore actuators. Standard construction includes: hard-anodized aluminum barrels; aluminum heads and end caps; O-ring piston and rod seals; bronze rod bearings; and stainless-steel rods. Specify Series FSM for head end nose mounting and Series FTM for cap end universal swivel mounting. The Digit-Air is also available as a single-acting, spring return cylinder (Series FTMR and FSMR). For spring return models, specify, after Series, -R for normally retracted or -E for normally extended. For special options, see page 16.

For ordering information, see page 18.

	FTM/FSM	FTMR/FSMR
Standard Bore Sizes	1/2, 3/4, 1 1/8	1/2, 3/4, 1 1/8
Stock Stroke Sizes (1/2" increments)	1/2" to 6"	1/2" to 3"
Pneumatic	200 psi max.	200 psi max.
Hydraulic	200 psi max.	200 psi max.
Bumpers available	Either/both ends	Normally extended: head end only Normally retracted cap end only

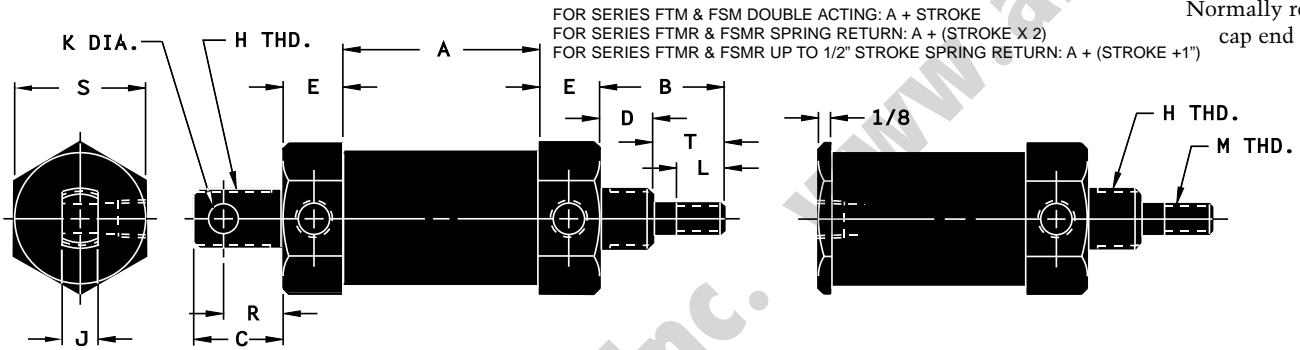

SERIES FTM/FTMR SWIVEL MOUNT CYLINDERS

SERIES FSM/FSMR NOSE MOUNT CYLINDERS

DIMENSIONAL DATA

Bore Size	A	B	C	D	E	H	J	K	L	M	R	S	T
1/2	1 1/16	1 1/4	13/16	1/2	9/16	1/2-20	1/4	1/4	1/2	1/4-28	9/16	3/4	3/4
3/4	1 1/16	1 1/4	13/16	1/2	9/16	5/8-18	1/4	1/4	1/2	1/4-28	9/16	1	3/4
1 1/8	1 1/16	1 5/16	15/16	9/16	5/8	5/8-18	3/8	5/16	1/2	5/16-24	5/8	1 3/8	3/4

Porting for all sizes is 1/8" N.P.T.F.

NOTE: For Series Digit-Air with bumpers, contact factory for stock stroke sizes and add 1/2" to Dimension "A" for each bumper.

MOUNTING ACCESSORIES

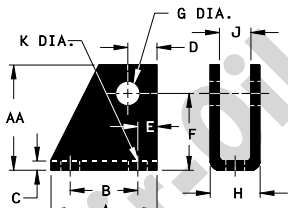

SWIVEL BRACKET

Bore Size	Number
1/2, 3/4	6/4-34
1 1/8	9-34

Connecting pin included.

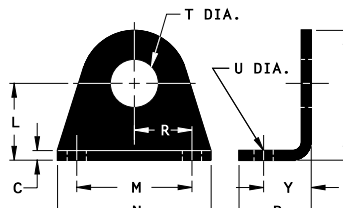

FOOT BRACKET

Bore Size	Number
1/2, 3/4	6/4-32
1 1/8	9-32

Mounting nut included.

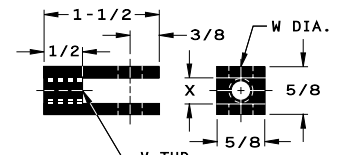

ROD CLEVIS

Bore Size	Number
1/2, 3/4	6/4-35
1 1/8	9-35

Connecting pin included.

Bore Size	A	AA	B	C	D	E	F	G	H	J	K	L	M	N	P	R	S	T	U	V	W	X	Y
1/2, 3/4	1 3/8	1 1/8	7/8	1/8	3/8	1/4	3/4	1/4	21/32	13/32	1/4	3/4	1	1 3/8	3/4	1/2	1 1/4	5/8	3/16	1/4-28	1/4	11/32	1/2
1 1/8	1 3/8	1 3/8	7/8	1/8	3/8	1/4	1	5/16	21/32	13/32	1/4	1	1 1/2	2	15/16	3/4	1 11/16	5/8	1/4	5/16-24	5/16	11/32	5/8

ROD NUT INCLUDED ON ALL DIGIT-AIR TYPE CYLINDERS

OPTIONS

SPECIFY AFTER STROKE:*

Cushions	(See pages 18 and 19 for ordering information)
Metal rod scraper (not available on I or DI type 1 ¹ / ₈ " bore cylinders or any SI or DSI type cylinders	MRS
Extra inlet ports head and/or cap end.....	Extra port(s) [indicate location(s) <i>and</i> head and/or cap end]
Tang at 90° from standard.....	Tang 90°
No tang (cap end includes projection for disassembly).....	NT
Non-stock stroke cylinders	(See pages 18 and 19 for ordering information)
Stainless steel circumflex keys	SS Keys
Viton packing [not available on F type (except Series FT), low friction, cylinders or magnetic switch cylinders]	Viton
Magnetic switches (available on magnetic switch cylinders).....	(See pages 18 and 19 for ordering information)
Heavy duty springs (available on single-acting cylinders)	(Indicate specifications)
Stop tubes	(See pages 18 and 19 for ordering information)
Permanent lubrication [available on F type cylinders (except Series FT), standard on low friction cylinders]	Perm Lube

SPECIAL ROD OPTIONS

SPECIFY AFTER STROKE:*

Special dimension "T" (rod extension)	T = (indicate dimension required)
Special dimension "L" (thread length)	L = (indicate dimension required)
Special dimension "M" (thread size)	M = (indicate thread size required or plain rod end)
Tapped hole in rod end	M = (indicate thread size and depth required)
Stainless steel rods	SS Rod
Oversized rods	(Indicate rod size required) Contact factory for sizes available.

**See pages 18 and 19 for ordering information.*

OPTIONS

SPECIFY AFTER STROKE:*

Bumpers**	(See pages 18 and 19 for ordering information)
Non-stock stroke cylinders	(See pages 18 and 19 for ordering information)
Viton packing (not available on Digit-Air M type cylinders)**.....	Viton
Magnetic switches (available on Digit-Air M type cylinders)	(See pages 18 and 19 for ordering information)
Stop tubes	(See pages 18 and 19 for ordering information)

SPECIAL ROD OPTIONS

SPECIFY AFTER STROKE:*

Special dimension "T" (rod extension)	T = (indicate dimension required)
Special dimension "L" (thread length)	L = (indicate dimension required)
Special dimension "M" (thread size)	M = (indicate thread size required or plain rod end)

**See pages 18 and 19 for ordering information.*

***Bumpers and Viton packing may not be compatible in some applications.*

DISASSEMBLY, HEAD END

Remove any plumbing from cylinder ports; wrap barrel in heavy cloth to prevent damage to barrel. Place cap end of cylinder barrel in vise. As you rotate head counter-clockwise, use a screw driver to lift end of circumflex key clear of slot (Fig. 1).

Continue rotation of head, and circumflex key will feed out of slot (Fig. 2). Gripping rod, pull forward. Head, rod and piston will come out of barrel (Fig. 4). Screw head off rod threads for ease of clearing rod packing.

CAP END

Slide head end back in barrel to support barrel and follow same procedure as above to remove circumflex key from cap end (Fig. 3). If cylinder has been used in wet or moist external conditions for a long period, circumflex key may be corroded. If this is the case, apply penetrating oil into the lock slots prior to disassembly.

ASSEMBLY

Replace piston (if necessary), rod packings and wiper and all static seals. Clean I.D. of tube thoroughly. Lubricate rod packings and O.D. of piston prior to assembly. To reassemble cylinder, follow above procedure, except heads will be turned clockwise after circumflex key is engaged in tang hole in circumflex groove of head. Turn clockwise until circumflex is completely into groove and cylinder port in head is aligned with port hole in barrel. To get head end over rod threads without damaging packing and wiper, wrap rod threads with tape.

NOTE: Lock nut must be replaced when piston is replaced (Fig. 4). Do not use old lock nut. Complete packing kits and lubricants are available for all Flairline cylinders and can be ordered from your Flairline distributor.

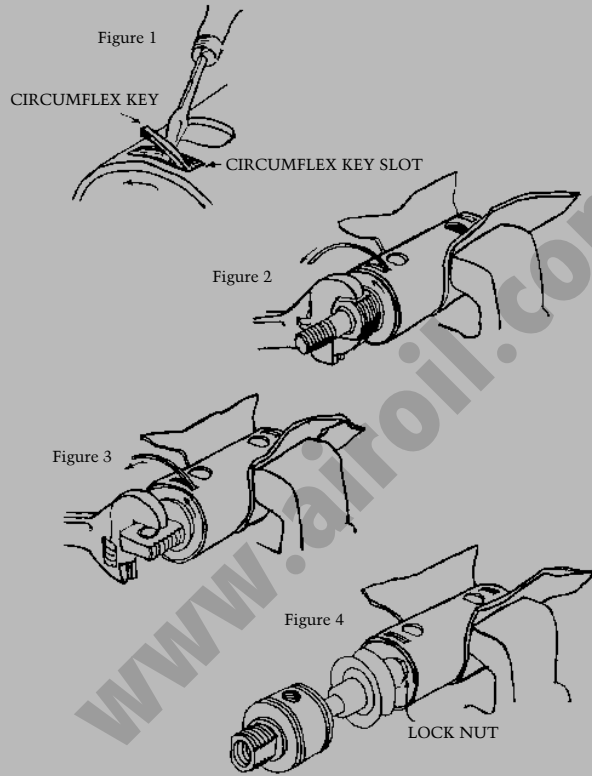

APPLICATION TIPS

FLAIRLINE HI-CYCLE CYLINDERS

Applications for pneumatic cylinders are limitless. Application assistance is available from your local Flairline distributor or from the many publications that are readily available throughout the fluid power industry. Pictured below are some typical pneumatic cylinder applications.

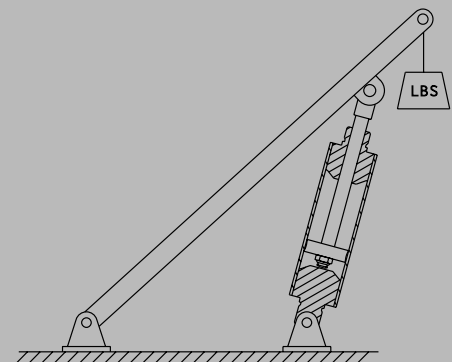
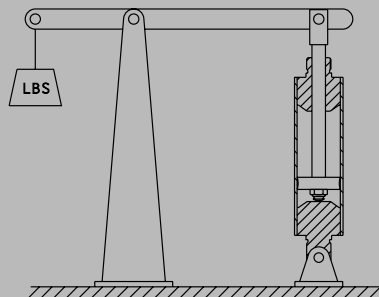
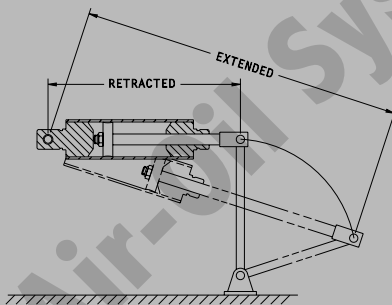

WARNING

Flairline's Series F 'uni-piston' should not be used in heavy sideload applications. When using an all rubber piston, it is possible for sideloading to cause a "jamming" condition. This will result in delayed actuation of the cylinder.

When sideloading is necessary, contact your local Flairline distributor or the factory for alternative piston configurations.

Flairline will not assume responsibility for the application of its products.

NOTE: All specifications and dimensions are subject to change without notice.

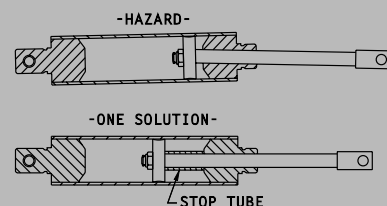

Sideloading commonly occurs when misalignment, deflection or extremely long strokes are present.

ORDERING INSTRUCTIONS

FLAIRLINE HI-CYCLE

F, O, H, D, I, DI, SI, DSI AND DIGIT-AIR® TYPE CYLINDERS

To order any products, specify information from categories listed below and arrange according to Example.

EXAMPLE:

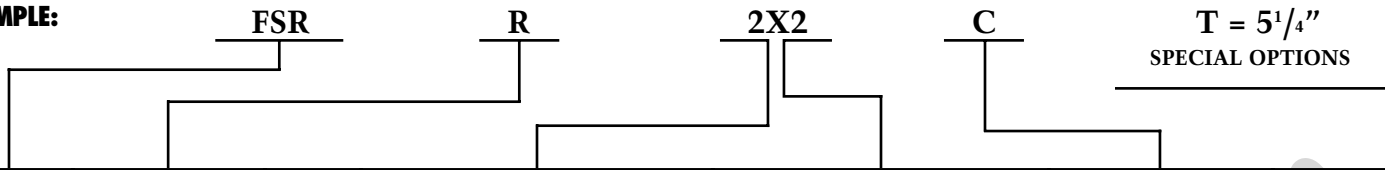

Series	Normal Spring Return Mode	Code	Bore	Stroke	Cushions	Code		
F O OLF H-D	N/A	N/A	1 ¹ / ₈ , 1 ¹ / ₂ , 2, 2 ¹ / ₂ , 3 ¹ / ₄ , 4	1" to 18"* (1" increments)	Head only Cap only Both	H C HC		
FDE			1 ¹ / ₈ , 1 ¹ / ₂ , 2, 2 ¹ / ₂	1" to 18"* (1" increments)	One end only Both	H HH		
ODE HDE DDE			1 ¹ / ₈ , 1 ¹ / ₂ , 2, 2 ¹ / ₂ , 3 ¹ / ₄ , 4					
FT DT			1 ¹ / ₂ , 2, 2 ¹ / ₂ , 3 ¹ / ₄ , 4	1" to 18"* (1" increments)	(Rod end unit only) Head only Cap only Both	H C HC		
FCC-OCC HCC-DCC **			1 ¹ / ₈ , 1 ¹ / ₂ , 2, 2 ¹ / ₂ , 3 ¹ / ₄ , 4	1" to 18"* (1" increments)	Head only Cap only Both	H C HC		
I-DI SI-DSI			1 ¹ / ₈ , 1 ¹ / ₂ , 2, 2 ¹ / ₂ , 3					
IDE DIDE SIDE DSIDE			1 ¹ / ₈ , 1 ¹ / ₂ , 2, 2 ¹ / ₂ , 3	1" to 18"* (1" increments)	One end only Both	H HH		
FTM FSM			1 ¹ / ₂ , 3 ¹ / ₄ , 1 ¹ / ₈	1/2" to 6" (1/2" increments)	(Bumpers)*** Head only Cap only Both	H C HC		
FSR			Normally Extended	E	2, 2 ¹ / ₂ , 3 ¹ / ₄ , 4	1" to 6" (1" increments)	Head only when Normally extended Cap only when Normally retracted	H C
OSR HSR-DSR					1 ¹ / ₈ , 1 ¹ / ₂ , 2, 2 ¹ / ₂ , 3 ¹ / ₄ , 4			
FTMR FSMR	Normally Retracted	R	1/2, 3/4, 1 1/8	1/2" to 3" (1/2" increments)	(Bumpers)*** Head only when Normally extended Cap only when Normally retracted	H C		

* Cylinders are available in even inch increments of stroke plus 1/2", 2 1/2" and 3 1/2" strokes in bore sizes 1/8, 1/2 and 2. All others (up to 130") are considered non-stock. Strokes over 40" may require oversized rods and/or stop tubes.

**To order Cap-to-Cap models:

EXAMPLE: $\frac{\text{FCC}}{\text{Model}} \frac{2}{\text{Bore}} \times \frac{6}{\text{Stroke}} \frac{\text{H}}{\text{Cushions}} \frac{\text{T} = 5\frac{1}{4}''}{\text{Special Options}} : \frac{2}{\text{Bore}} \times \frac{8}{\text{Stroke}} \frac{\text{HC}}{\text{Cushions}} \frac{\text{Special Options}}{\text{Special Options}}$

***When specifying bumpers, contact factory for stock stroke sizes.

SPECIAL NOTE: WHEN ORDERING A CYLINDER WITH A STOP TUBE, SPECIFY "TOTAL" STROKE INCLUDING THE STOP TUBE LENGTH IN THE "STROKE" CATEGORY. IN THE "SPECIAL OPTIONS" CATEGORY, SPECIFY THE STOP TUBE LENGTH.

REPLACEMENT PARTS, PACKING KITS AND LUBRICANTS ARE AVAILABLE FOR ALL FLAIRLINE CYLINDERS

All specifications and dimensions are subject to change without notice.

ORDERING INSTRUCTIONS

To order any products, specify information from categories listed below and arrange according to Example.

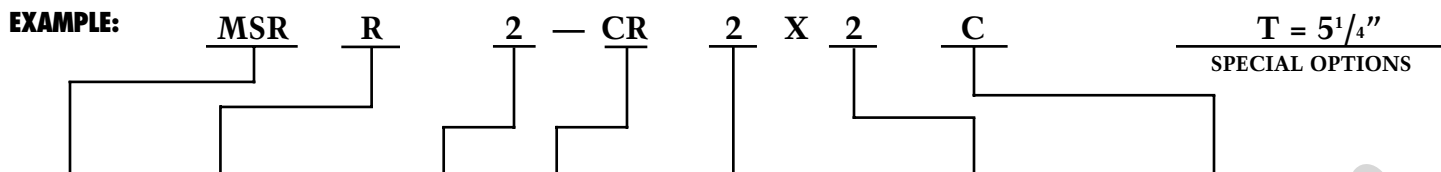

Series	Normal Spring Return Mode	Code	No. of Switches	Switch Model	Bore	Stroke	Cushions	Code
M DM	N/A	N/A	Qty.	43-CR 43-HP 43-HN (use suffix only)	1 1/8, 1 1/2, 2, 2 1/2, 3 1/4, 4	1" to 18"* (1" increments)	Head only Cap only Both	H C HC
MDE DMDE					1 1/8, 1 1/2, 2, 2 1/2, 3 1/4, 4	1" to 18"* (1" increments)	One end only Both	H HH
MT DMT					1 1/2, 2, 2 1/2, 3 1/4, 4	1" to 18"* (1" increments)	(Rod end unit only) Head only Cap only Both	H C HC
MCC DMCC **					1 1/8, 1 1/2, 2, 2 1/2, 3 1/4, 4	1" to 18"* (1" increments)	(Rod end unit only) Head only Cap only Both	H C HC
DIM DSIM					1 1/8, 1 1/2, 2, 2 1/2, 3	1" to 18"* (1" increments)	Head only Cap only Both	H C HC
DIMDE DSIMDE					1 1/8, 1 1/2, 2, 2 1/2, 3	1" to 18"* (1" increments)	One end only Both	H HH
MTM MSM					1/2, 3/4, 1 1/8	See page 10	(Bumpers)*** Head only Cap only Both	H C HC
MSR DMSR					Normally Extended	E	1 1/8, 1 1/2, 2, 2 1/2, 3 1/4, 4	1" to 6" (1" increments)
MTMR MSMR	Normally Retracted	R	1/2, 3/4, 1 1/8	See page 10	(Bumpers)*** Head only Cap only Both	H C HC		

*Cylinders are available in even inch increments of stroke plus 1 1/2", 2 1/2" and 3 1/2" strokes in bore sizes 1 1/8, 1 1/2 and 2. All others (up to 130") are considered non-stock. Strokes over 40" may require oversized rods and/or stop tubes.

**To order Cap-to-Cap models:

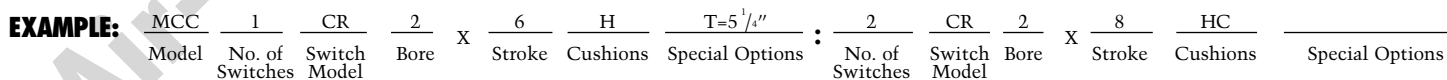

***When specifying bumpers, contact factory for stock stroke sizes.

OTHER FLAIRLINE MAGNETIC SWITCH CYLINDERS INCLUDE SERIES OIM AND OIMNR ON PAGE 22

SPECIAL NOTE: WHEN ORDERING A CYLINDER WITH A STOP TUBE, SPECIFY "TOTAL" STROKE INCLUDING THE STOP TUBE LENGTH IN THE "STROKE" CATEGORY. IN THE "SPECIAL OPTIONS" CATEGORY, SPECIFY THE STOP TUBE LENGTH.

REPLACEMENT PARTS, PACKING KITS AND LUBRICANTS ARE AVAILABLE FOR ALL FLAIRLINE CYLINDERS

All specifications and dimensions are subject to change without notice.

ONLY THE TIE RODS ARE MISSING

Eliminating the tie rods means space-saving NFPA mounting, lighter weight and easy maintenance. Flairline heavy duty features provide millions of trouble-free cycles less expensively than equivalent tie rod cylinders.

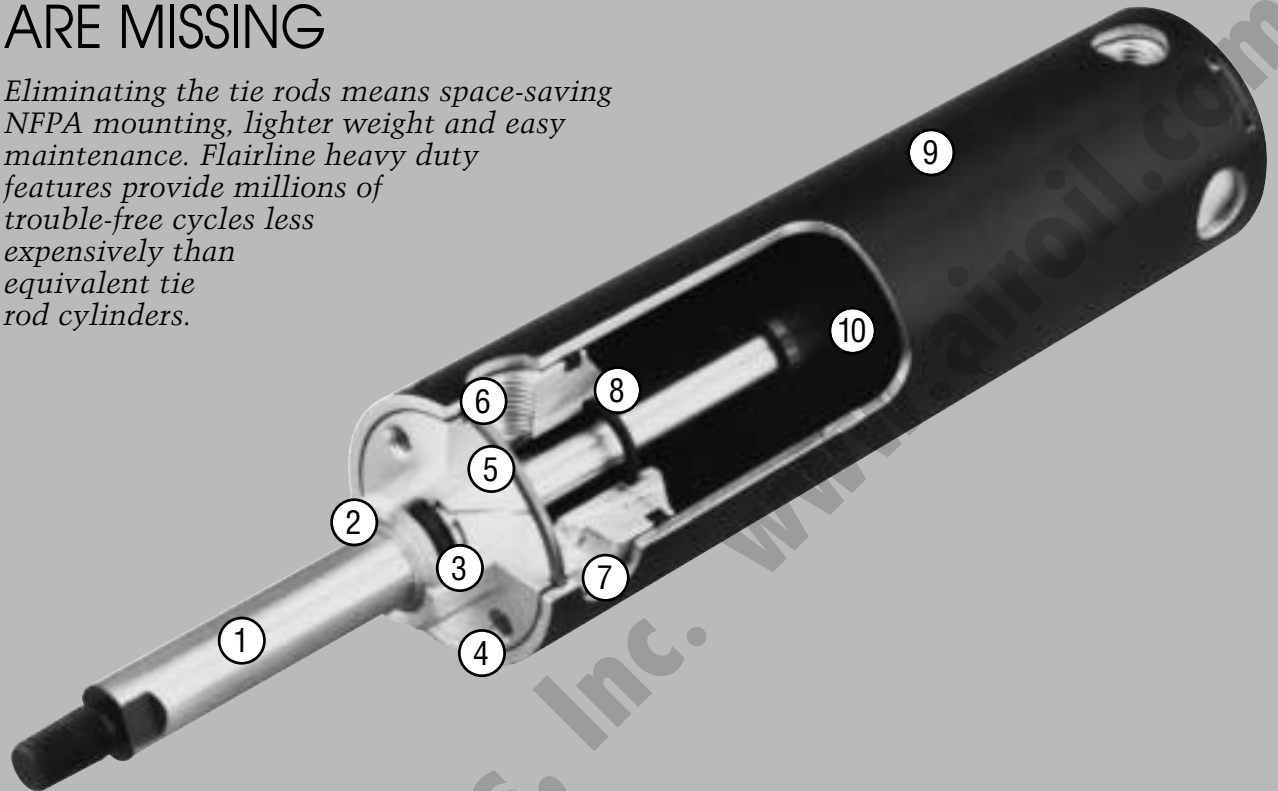

1. Chrome-plated, high-strength, steel piston rods are corrosion resistant, rugged and durable. Three NFPA rod end options are offered. Optional stainless steel is available upon request.

2. High-quality elastomer rod wiper protects rod seal by preventing contaminants from entering cylinder during retract stroke. Resilient synthetic rubber will not scratch rod.

3. Pressure-energized, U-cup type rod seal is wear compensating, low friction and provides positive sealing.

4. Lightweight aluminum heads and caps provide long corrosion-resistant life.

5. Extra-long, low-friction nylon rod bearing 'gives' rather than wears under normal side loading. When necessary, service is easy; only the bearing is replaced, not the head.

6. Heads and caps are held to tube by means of a circumflex key. The large square steel locking device requires no special installation tools. Service to head or cap can be done without disassembling the entire cylinder.

7. Adjustable cushions, available on 2" bore and larger, are flush with the O.D. of the cylinder. The 1½" bore has fixed cushions.

8. Cushion seal "check valve" offers fast break-away, self-aligning, positive cushioning for faster stroking and reduced cylinder wear.

9. Precision-drawn, lightweight aluminum barrels are hard-anodized inside and out for corrosion and abrasion resistance. Fine I.D. microfinish provides long life and positive sealing.

10. Several piston styles are offered for various application requirements. See pages 21 and 22 for details.

DOUBLE-ACTING CYLINDERS

NFPA INTERCHANGEABLE

FLAIRLINE HI-CYCLE
SERIES FI, OI AND OILF



Flairline double-acting NFPA interchangeable cylinders can be used in nearly all applications where lightweight, economical, long-service actuators are required. Operating systems can be pneumatic or hydraulic. Low friction, pneumatic service is available with Series OILF which is designed primarily for use on low pressure applications and where low minimum break-away is required. See page 23 for dimensional data, pages 24 and 25 for mounting styles, page 25 for rod end styles and page 26 for accessories. For special options, see page 28.

For ordering information, see page 29.

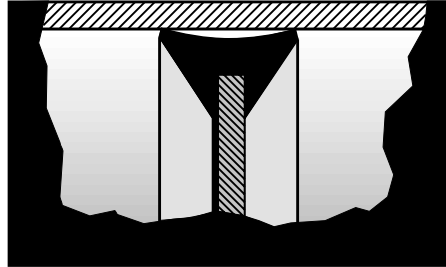

F TYPE PISTON

Pressure energized, wear compensating double lip type, 'uni-piston' seal (Buna N). Rubber bonded to a plated disc to assure positive sealing, will outlast O-rings and can never score cylinder I.D.

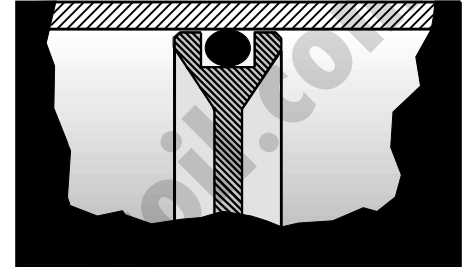

O TYPE PISTON

Dynamic O-ring piston seal (Buna N standard; Viton available only on Series O). Side loading will greatly reduce effectiveness of Series OILF.

FI

Standard Bore Sizes – 1½, 2, 2½, 3¼, 4
Stock Stroke Sizes – 1" to 18" (1" increments)
Cushions available – either/both ends
Pneumatic only – 150 psi maximum

OI/OILF

Standard Bore Sizes – 1½, 2, 2½, 3¼, 4
Stock Stroke Sizes – 1" to 18" (1" increments)
Cushions available – either/both ends
Pneumatic – 150 psi maximum
Hydraulic – consult factory

DOUBLE-ACTING DOUBLE-ENDED CYLINDERS

NFPA INTERCHANGEABLE

FLAIRLINE HI-CYCLE
SERIES FIDE AND OIDE



Flairline double-acting double-ended NFPA interchangeable cylinders feature piston rod extensions from each end and a choice of F or O type pistons. As one end is extended, the opposite end is retracted. Working range (stroke), force and speed are equal in both directions so work can be accomplished at both ends simultaneously. See page 23 for dimensional data, pages 24 and 25 for mounting styles, page 25 for rod end styles and page 26 for accessories. For special options, see page 28.

For ordering information, see page 29.

FIDE

1½ to 2½
1" to 18"
either/both ends
150 psi max.
N/A

OIDE

1½ to 4
1" to 18"
either/both ends
150 psi max.
consult factory

Standard Bore Sizes
Stock Stroke Sizes (1" increments)
Cushions available
Pneumatic
Hydraulic

MAGNETIC SWITCH CYLINDERS

NFPA INTERCHANGEABLE

FLAIRLINE HI-CYCLE

SERIES OIM



Series OIM magnetic switch NFPA interchangeable double-acting cylinders provide magnetic switch service with specially designed pistons which include factory installed magnets. See page 8 for magnetic switch options including Reed and Hall Effect types. See page 23 for dimensional data, pages 24 and 25 for mounting styles, page 25 for rod end styles and page 26 for accessories. For special options, see page 28.

For ordering information, see page 29.

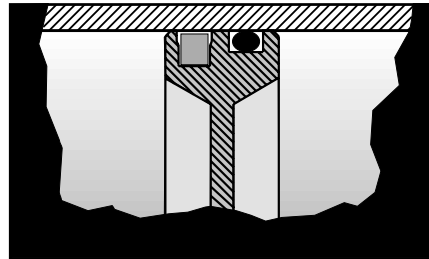

OIM TYPE PISTON

Dynamic O-ring piston seal (Buna N), piston includes magnet.

OIM

Standard Bore Sizes – 1¹/₂, 2, 2¹/₂, 3¹/₄, 4
 Stock Stroke Sizes – 1" to 18" (1" increments)
 Cushions available – either/both ends
 Pneumatic – 150 psi maximum
 Hydraulic – consult factory

DOUBLE-ACTING NON-ROTATING CYLINDERS

NFPA INTERCHANGEABLE

FLAIRLINE HI-CYCLE

SERIES FINR, OINR AND OIMNR



Series FINR, OINR and OIMNR are dimensionally interchangeable with Flairline Series FI and Series OI NFPA cylinders except for the non-rotating feature consisting of two external chrome-plated steel guide rods, guide flange (MF1) and steel rod end mounting block.

Flairline double-acting non-rotating cylinders feature a choice of F type pistons (Series FINR), O type pistons (Series OINR) or OIM type pistons (Series OIMNR). Series OIMNR provides magnetic switch service. See page 8 for magnetic switch options including Reed and Hall Effect types. See page 23 for dimensional data, pages 24 and 25 for mounting styles and page 26 for accessories. For special options, see page 28.

For ordering information, see page 29.

FINR

Standard Bore Sizes – 1¹/₂, 2, 2¹/₂
 Stock Stroke Sizes – 1" to 18" (1" increments)*
 Cushions available – either/both ends**
 Pneumatic only – 150 psi maximum

OINR

Standard Bore Sizes – 1¹/₂, 2, 2¹/₂
 Stock Stroke Sizes – 1" to 18" (1" increments)
 Cushions available – either/both ends
 Pneumatic – 150 psi maximum
 Hydraulic – consult factory

OIMNR

Standard Bore Sizes – 1¹/₂, 2, 2¹/₂
 Stock Stroke Sizes – 1" to 18" (1" increments)
 Cushions available – either/both ends
 Pneumatic – 150 psi maximum
 Hydraulic – consult factory

* Series FINR is not recommended for stroke requirements in excess of 18".

DIMENSIONAL DATA

NFPA INTERCHANGEABLE

FLAIRLINE HI-CYCLE

SERIES FI, OI, OILF, OIM, FIDE AND OIDE

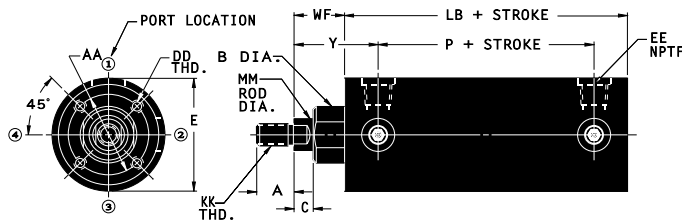

SERIES FI/OI/OILF/OIM

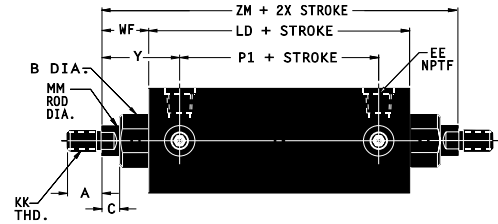

SERIES FIDE/OIDE

DIMENSION REFERENCE	CYLINDER BORE					DIMENSION REFERENCE	CYLINDER BORE				
	1 1/2	2	2 1/2	3 1/4*	4*		1 1/2	2	2 1/2	3 1/4*	4*
A	3/4	3/4	3/4	1 1/8	1 1/8	LB	3 5/8	3 5/8	3 3/4	4 1/4	4 1/4
AA	1.21	1.60	2.00	2.62	2.62	LD	4 1/8	4 1/8	4 1/4	4 3/4	4 3/4
B	1 1/8	1 1/8	1 1/8	1 1/2	1 1/2	MM	5/8	5/8	5/8	1	1
C	3/8	3/8	3/8	1/2	1/2	P	2.29	2.29	2.42	2.44	2.44
DD	6-32	1/4-20	5/16-18	3/8-16	3/8-16	P1	2.79	2.79	2.92	2.94	2.94
E	1 3/4	2 1/4	2 3/4	3 1/2	4 1/4	WF	1	1	1	1 3/8	1 3/8
EE-NPTF	1/4-18	1/4-18	1/4-18	1/2-14	1/2-14	Y	1.67	1.67	1.67	2.28	2.28
KK	7/16-20	7/16-20	7/16-20	3/4-16	3/4-16	ZM	6 1/8	6 1/8	6 1/4	7 1/2	7 1/2

*Series FIDE not available in 3/4 or 4 bore.

See pages 24 and 25 for mounting styles, page 25 for rod end styles and page 26 for accessories. For special options, see page 28 and for ordering information, see page 29.

DIMENSIONAL DATA

NFPA INTERCHANGEABLE

FLAIRLINE HI-CYCLE

SERIES FINR, OINR AND OIMNR

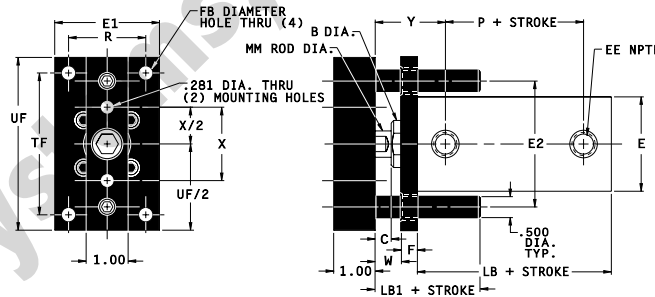

SERIES FINR/OINR/OIMNR

DIMENSION REFERENCE	CYLINDER BORE			DIMENSION REFERENCE	CYLINDER BORE		
	1 1/2	2	2 1/2		1 1/2	2	2 1/2
B	1 1/8	1 1/8	1 1/8	MM	5/8	5/8	5/8
C	3/8	3/8	3/8	P	2.29	2.29	2.42
E	1 3/4	2 1/4	2 3/4	R	1.43	1.84	2.19
E1	2	2 1/2	3	TF	2.75	3.38	3.88
E2	2 1/2	3	3 1/2	UF	3 3/8	4 1/8	4 5/8
EE-NPTF	1/4-18	1/4-18	1/4-18	UF/2	1 11/16	2 1/16	2 5/16
F	3/8	3/8	3/8	W	5/8	5/8	5/8
FB	9/32	11/32	11/32	X	1 1/4	1 3/4	2
LB	3 5/8	3 5/8	3 3/4	X/2	5/8	7/8	1
LB1	1 1/2	1 1/2	1 1/2	Y	1.67	1.67	1.67

See pages 24 and 25 for mounting styles and page 26 for accessories. For special options, see page 28. and for ordering information, see page 29.

FLAIRLINE NFPA INTERCHANGEABLE CYLINDERS ARE AVAILABLE
WITH YOUR CHOICE OF FACTORY INSTALLED MOUNTINGS

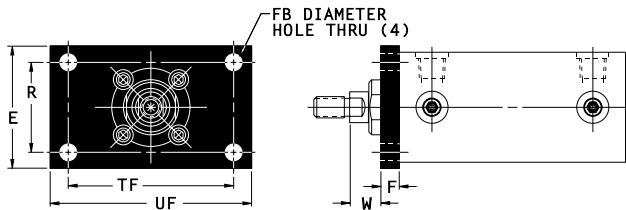

FRONT FLANGE MOUNT (NFPA MF1)

Bore Size	DIMENSIONS						
	E	F	FB	R	TF	UF	W
1 1/2	2	3/8	9/32	1.43	2.75	3 3/8	5/8
2	2 1/2	3/8	11/32	1.84	3.38	4 1/8	5/8
2 1/2	3	3/8	11/32	2.19	3.88	4 5/8	5/8
3 1/4	3 3/4	5/8	13/32	2.76	4.69	5 1/2	3/4
4	4 1/2	5/8	13/32	3.32	5.44	6 1/4	3/4

Included on Series FINR, OINR and OIMNR.

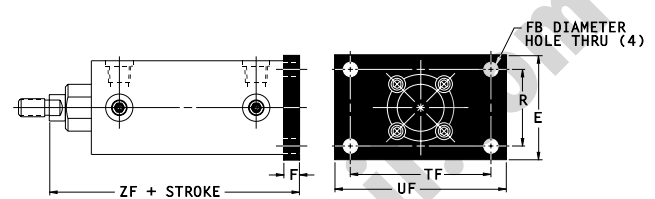

REAR FLANGE MOUNT (NFPA MF2)

Bore Size	DIMENSIONS						
	E	F	FB	R	TF	UF	ZF
1 1/2	2	3/8	9/32	1.43	2.75	3 3/8	5
2	2 1/2	3/8	11/32	1.84	3.38	4 1/8	5
2 1/2	3	3/8	11/32	2.19	3.88	4 5/8	5 1/8
3 1/4	3 3/4	5/8	13/32	2.76	4.69	5 1/2	6 1/4
4	4 1/2	5/8	13/32	3.32	5.44	6 1/4	6 1/4

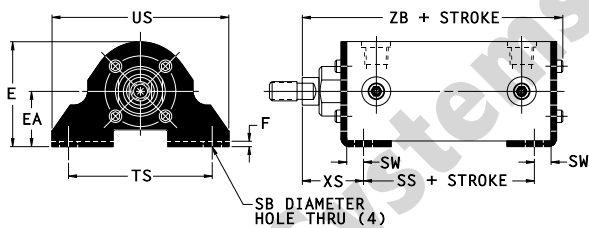

SIDE LUG MOUNTS (NFPA MS2)

Bore Size	DIMENSIONS									
	E	EA	F	SB	SS	SW	TS	US	XS	ZB
1 1/2	1 7/8	1	1/8	13/32	2 7/8	3/8	2 3/4	3 1/2	1 3/8	4.92
2	2 3/8	1 1/4	1/8	13/32	2 7/8	3/8	3 1/4	4	1 3/8	4.95
2 1/2	2 7/8	1 1/2	3/16	13/32	3	3/8	3 3/4	4 1/2	1 3/8	5.19
3 1/4	3 5/8	1 7/8	1/4	17/32	3 1/4	1/2	4 3/4	5 3/4	1 7/8	6.19
4	4 3/8	2 1/4	5/16	17/32	3 1/4	1/2	5 1/2	6 1/2	1 7/8	6.25

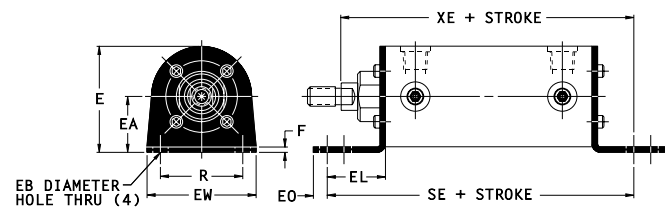

END LUG MOUNTS (NFPA MS7)

Bore Size	DIMENSIONS									
	E	EA	EB	EL	EO	EW	F	R	SE	XE
1 1/2	1 7/8	1	9/32	1 1/8	1/4	2	1/8	1.43	5 1/2	5 3/8
2	2 3/8	1 1/4	11/32	1 5/16	5/16	2 7/16	1/8	1.84	5 7/8	5 9/16
2 1/2	2 7/8	1 1/2	11/32	1 7/16	7/16	3	3/16	2.19	6 1/4	5 13/16
3 1/4	3 5/8	1 7/8	13/32	1 1/2	3/8	3 1/2	1/4	2.76	6 5/8	6 1/2
4	4 3/8	2 1/4	13/32	1 5/8	3/8	4 1/4	5/16	3.32	6 7/8	6 5/8

Not available on Series FINR, OINR or OIMNR.

For additional mounting styles, see page 25.

See pages 25 for rod end styles and page 26 for accessories. For special options, see page 28 and for ordering information, see page 29.

MOUNTING STYLES

NFPA INTERCHANGEABLE

FLAIRLINE HI-CYCLE
NFPA TYPE CYLINDERS

FLAIRLINE NFPA INTERCHANGEABLE CYLINDERS ARE AVAILABLE WITH YOUR CHOICE OF FACTORY INSTALLED MOUNTINGS

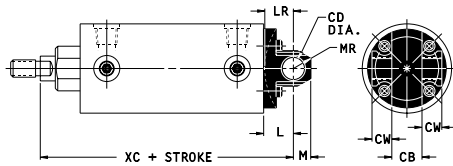

CLEVIS MOUNT (NFPA MP1)

Bore Size	DIMENSIONS							
	CB	CD	CW	L	LR	M	MR	XC
1 1/2	3/4	1/2	1/2	3/4	9/16	7/16	1/2	5 3/8
2	3/4	1/2	1/2	3/4	3/4	7/16	1/2	5 3/8
2 1/2	3/4	1/2	1/2	3/4	3/4	7/16	1/2	5 1/2
3 1/4, 4	1 1/4	3/4	5/8	1 1/4	1 1/8	5/8	3/4	6 7/8

Pivot pin included.

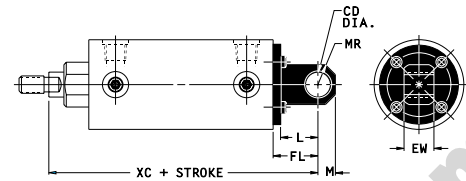

PIVOT MOUNT (NFPA MP4)

Bore Size	DIMENSIONS						
	CD	EW	FL	L	M	MR	XC
1 1/2	1/2	3/4	1 1/8	15/16	7/16	1/2	5 3/4
2	1/2	3/4	1 1/8	15/16	7/16	1/2	5 3/4
2 1/2	1/2	3/4	1 1/8	15/16	7/16	1/2	5 7/8
3 1/4, 4	3/4	1 1/4	1 7/8	1 3/8	5/8	3/4	7 1/2

See page 26 for optional pivot pin.

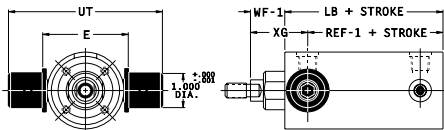

HEAD TRUNNION MOUNT (NFPA MT1)

Bore Size	DIMENSIONS					
	E	LB	REF-1	UT	WF-1	XG
2	2 1/2	3 5/8	2.96	4 1/2	1.08	1 3/4
2 1/2	3	3 3/4	3.08	5	1.08	1 3/4
3 1/4	3 3/4	4 1/4	3.41	5 3/4	1.41	2 1/4
4	4 1/2	4 1/4	3.41	6 1/2	1.41	2 1/4

Not available on Series FINR, OINR or OIMNR.

If cushions are required on cylinders with MT1 or MT2 mounts, the cushion adjustments are located in position 3.

See page 26 for accessories and page 28 for special options. For ordering information, see 29.

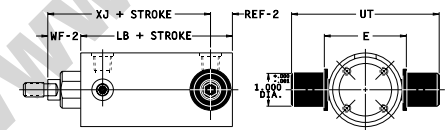

CAP TRUNNION MOUNT (NFPA MT2)

Bore Size	DIMENSIONS					
	E	LB	REF-2	UT	WF-2	XJ
2	2 1/2	3 5/8	.66	4 1/2	1.16	4 1/8
2 1/2	3	3 3/4	.66	5	1.16	4 1/4
3 1/4	3 3/4	4 1/4	.91	5 3/4	1.66	5
4	4 1/2	4 1/4	.91	6 1/2	1.66	5

ROD END STYLES

NFPA INTERCHANGEABLE

FLAIRLINE HI-CYCLE
SERIES FI, OI, OILF, OIM, FIDE AND OIDE

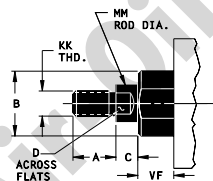

SMALL MALE (NFPA SM)*

Bore Size	DIMENSIONS						
	A	B	C	D	KK	MM	VF
1 1/2, 2, 2 1/2	3/4	1 1/8	3/8	1/2	7/16-20	5/8	5/8
3 1/4, 4	1 1/8	1 1/2	1/2	7/8	3/4-16	1	7/8

*Standard on all Flairline NFPA interchangeable cylinders. When ordering, if no rod end style is specified, style SM will be supplied. Rod eye and rod clevis fit style SM. Rod nut included.

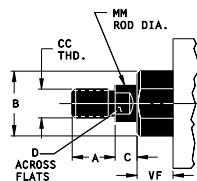

INTERMEDIATE MALE (NFPA IM)*

Bore Size	DIMENSIONS						
	A	B	C	CC	D	MM	VF
1 1/2, 2, 2 1/2	3/4	1 1/8	3/8	1/2-20	1/2	5/8	5/8
3 1/4, 4	1 1/8	1 1/2	1/2	7/8-14	7/8	1	7/8

*Optional. Rod nut included.

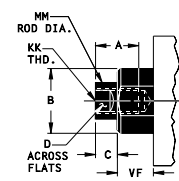

SHORT FEMALE (NFPA SF)*

Bore Size	DIMENSIONS						
	A	B	C	D	KK	MM	VF
1 1/2, 2, 2 1/2	3/4	1 1/8	3/8	1/2	7/16-20	5/8	5/8
3 1/4, 4	1 1/8	1 1/2	1/2	7/8	3/4-16	1	7/8

*Optional.

See page 26 for accessories and page 28 for special options. For ordering information, see 29.

ACCESSORIES

NFPA INTERCHANGEABLE

FLAIRLINE HI-CYCLE NFPA TYPE CYLINDERS

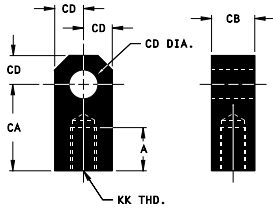

ROD EYE*

Bore Size	DIMENSIONS					
	Number	A	CA	CB	CD	KK
1 ¹ / ₂ , 2, 2 ¹ / ₂	4-36-3	³ / ₄	1 ¹ / ₂	³ / ₄	¹ / ₂	⁷ / ₁₆ -20
3 ¹ / ₄ , 4	4-36-65	1 ¹ / ₈	2 ¹ / ₁₆	1 ¹ / ₄	³ / ₄	³ / ₄ -16

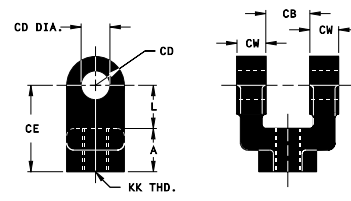

ROD CLEVIS*

Bore Size	DIMENSIONS							
	Number	A	CB	CD	CE	CW	L	KK
1 ¹ / ₂ , 2, 2 ¹ / ₂	4-35-3	³ / ₄	³ / ₄	¹ / ₂	1 ¹ / ₂	¹ / ₂	³ / ₄	⁷ / ₁₆ -20
3 ¹ / ₄ , 4	4-35-65	1 ¹ / ₈	1 ¹ / ₄	³ / ₄	2 ³ / ₈	⁵ / ₈	1 ¹ / ₄	³ / ₄ -16

Pivot pin included.

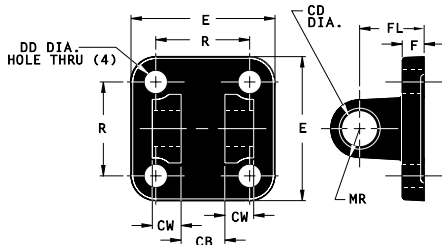

CLEVIS BRACKET

Bore Size	DIMENSIONS									
	Number	CB	CD	CW	DD	E	F	FL	MR	R
1 ¹ / ₂ , 2, 2 ¹ / ₂	4-34-3	³ / ₄	¹ / ₂	¹ / ₂	¹³ / ₃₂	2 ¹ / ₂	³ / ₈	1 ¹ / ₈	¹ / ₂	1 ⁵ / ₈
3 ¹ / ₄ , 4	4-34-65	1 ¹ / ₄	³ / ₄	⁵ / ₈	¹⁷ / ₃₂	3 ¹ / ₂	⁵ / ₈	1 ⁷ / ₈	³ / ₄	2 ⁹ / ₁₆

Pivot pin included.

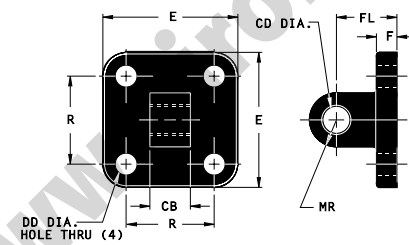

PIVOT BRACKET

Bore Size	DIMENSIONS									
	Number	CB	CD	DD	E	F	FL	MR	R	
1 ¹ / ₂ , 2, 2 ¹ / ₂	4-37-3	³ / ₄	¹ / ₂	¹³ / ₃₂	2 ¹ / ₂	³ / ₈	1 ¹ / ₈	¹ / ₂	1 ⁵ / ₈	
3 ¹ / ₄ , 4	4-37-65	1 ¹ / ₄	³ / ₄	¹⁷ / ₃₂	3 ¹ / ₂	⁵ / ₈	1 ⁷ / ₈	³ / ₄	2 ⁹ / ₁₆	

See optional pivot pin below.

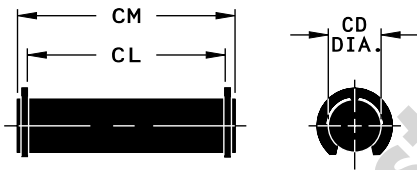

PIVOT PIN

Bore Size	DIMENSIONS			
	Number	CD	CL	CM
1 ¹ / ₂ , 2, 2 ¹ / ₂	BKT. PIN F 3 ¹ / ₄ , 4	¹ / ₂	1 ⁷ / ₈	2 ¹ / ₁₆
3 ¹ / ₄ , 4	PIVOT PIN FI 3 ¹ / ₄ , 4	³ / ₄	2 ⁹ / ₁₆	2 ⁷ / ₈

Snap rings included.

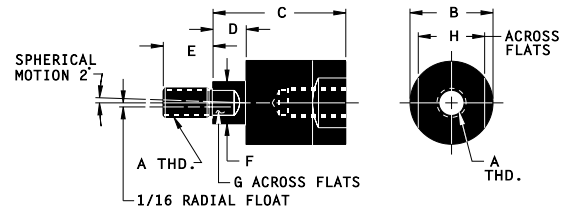

ALIGNMENT COUPLER*

Part Number	DIMENSIONS								Max. Pull at Yield
	A	B	C	D	E	F	G	H	
4-39-3	⁷ / ₁₆ -20	1 ¹ / ₄	2	¹ / ₂	³ / ₄	⁵ / ₈	¹ / ₂	1	10,000
4-39-3A	¹ / ₂ -20	1 ¹ / ₄	2	¹ / ₂	³ / ₄	⁵ / ₈	¹ / ₂	1	14,000
4-39-65	³ / ₄ -16	1 ³ / ₄	2 ⁵ / ₁₆	¹ / ₂	1 ¹ / ₈	³¹ / ₃₂	¹³ / ₁₆	1 ¹ / ₂	34,000
4-39-65A	⁷ / ₈ -14	1 ³ / ₄	2 ⁵ / ₁₆	¹ / ₂	1 ¹ / ₈	³¹ / ₃₂	¹³ / ₁₆	1 ¹ / ₂	39,000

Alignment couplers improve bearing and seal life by preventing excessive binding and friction caused by misalignment. Flairline alignment couplers also allow greater assembly tolerances than would typically be required which help simplify cylinder installation. Alignment couplers work equally well in "push" or "pull" applications and are available for all Flairline cylinders.

*Not available on Series FINR, OINR or OIMNR.
See page 28 for special options and page 29 for ordering information.

VOLUME CHAMBERS

SERIES VC

Flairline offers a wide range of volume chambers for a variety of uses. These volume chambers are constructed of lightweight aluminum caps and barrels. The barrels are hard-anodized for corrosion resistance. The optional mountings are NFPA interchangeable and are made of anodized aluminum or oxidized steel. See page 24 for mounting styles.

For ordering information, see page 18.

Standard Bore Sizes – 1½, 2, 2½, 3¼, 4
 Stock Length Sizes – 1" to 18" (1" increments)
 Pneumatic – 150 psi maximum
 Hydraulic – consult factory

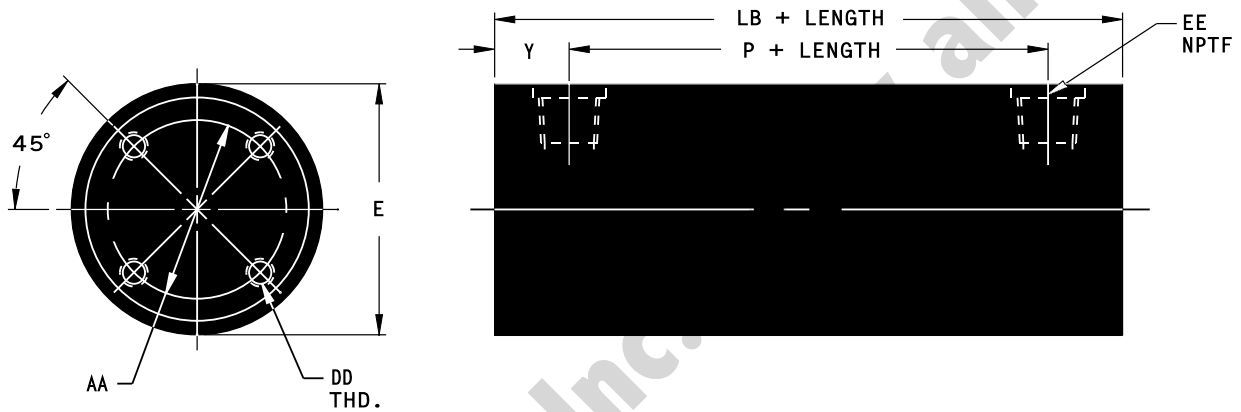

DIMENSIONAL DATA

Bore Size	DIMENSIONS						
	AA	E	DD	EE	LB	P	Y
1½	1.21	1¾	#6-32 X ½	¼-18	3⅝	2.29	.67
2	1.60	2¼	¼-20 X ⅝	¼-18	3⅝	2.29	.67
2½	2.00	2¾	⅝-18 X ¾	¼-18	3¾	2.42	.67
3¼	2.62	3½	⅜-16 X 7/8	½-14	4¼	2.44	.91
4	2.62	4¼	⅜-16 X 7/8	½-14	4¼	2.44	.91

VOLUME DATA

Bore Size	DIMENSIONS	
	Basic Volume (add to total)	Add per 1.0 inch of length
1½	1.95 in³	1.77 in³
2	3.35 in³	3.14 in³
2½	4.14 in³	4.91 in³
3¼	8.45 in³	8.30 in³
4	11.29 in³	12.57 in³

OPTIONS

SPECIFY AFTER MOUNTING STYLE:

Cushions	(See page 29 for ordering information)
Metal rod scraper (not available on 3 ¹ / ₄ or 4 bore cylinders).....	MRS
Extra inlet ports head and/or cap end	Extra port(s) [indicate location(s) <i>and</i> head and/or cap end]*
Inlet ports non-standard location – head and/or cap end	Port(s) [indicate location(s) <i>and</i> head and/or cap end]*
Non-stock stroke cylinders	(See page 29 for ordering information)
Stainless steel circumflex keys	SS Keys
Viton packing (available on Series OI, OIDE and OINR)	Viton
Magnetic Switches (available on Series OIM and OIMNR)	(See page 29 for ordering information)
Stop tubes	(See page 29 for ordering information)
Permanent lubrication (standard on Series OILE, available on Series FI, FIDE, and FINR)	Perm Lube

**Series FINR, OINR and OIMNR - on head end: available only in position three; on cap end: available in all positions.*

SPECIAL ROD OPTIONS*

SPECIFY AFTER MOUNTING STYLE:

Rod end styles Intermediate Male (NFPA IM) or Short Female (NFPA SF)	IM or SF**
Special dimension "C" (rod extension)	C = (indicate dimension required)
Special dimension "A" (thread length)	A = (indicate dimension required)
Special dimension "XX" (male thread size)	XX = (indicate thread size required or plain rod end)
Tapped hole in end of rod (female thread size).....	XX = (indicate thread size and depth required – unless otherwise specified, all other dimensions will be Short Female)
Stainless steel rods	SS Rod

**Special rod options applying to Series FINR, OINR and OIMNR include only: Special dimension "C" and stainless steel rods.*

***If no rod end style is specified, Small Male (NFPA SM) will be supplied. Rod eye and rod clevis fit style SM. See pages 25 and 26 for rod end styles and accessories.*

ORDERING INSTRUCTIONS

NFPA INTERCHANGEABLE

FLAIRLINE HI-CYCLE

NFPA TYPE CYLINDERS AND SERIES VC

To order any products, specify information from categories listed below and arrange according to Example.

EXAMPLE:

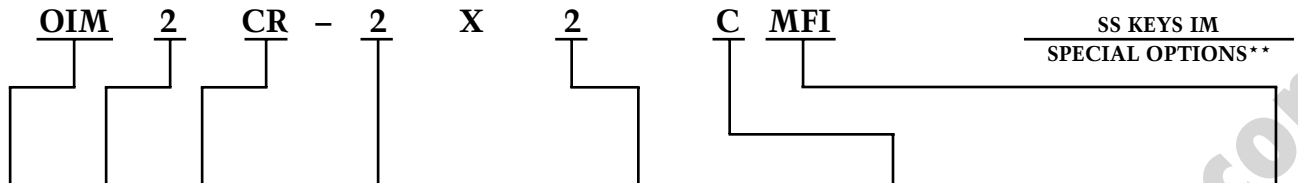

Series	No. of Switches	Switch Model	Bore	Stroke	Cushions	Code	Mounting Style
FI OI OILF	N/A	N/A	1 1/2, 2, 2 1/2 3 1/4, 4	1" to 18"* (1" increments)	Head Only Cap Only Both	H C HC	MF1, MF2 MS2, MS7 MP1, MP4 MT1, MT2***
OIM	Qty.	43-CR 43-HP 43-HN (Use suffix only)					
OIMNR			1 1/2, 2, 2 1/2		One end only Both	H HH	MF1, MS2 MS7, MT1 MT2***
FINR OINR							
FIDE OIDE	N/A	N/A	1 1/2, 2, 2 1/2 3 1/4, 4	N/A	N/A	MF1, MS2, MS7	
VC							

*Cylinders are available in even inch increments of stroke plus 1 1/2", 2 1/2" and 3 1/2" strokes in bore sizes 1 1/2 and 2. All others (up to 130") are considered non-stock. Strokes over 40" may require oversized rods and/or stop tubes.

**The special options in the example are stainless steel circumflex keys and rod end style - Intermediate Male (NFPA IM).

***MT1 and MT2 mounting styles not available on 1 1/2 bore cylinders.

SPECIAL NOTE: WHEN ORDERING A CYLINDER WITH A STOP TUBE, SPECIFY "TOTAL" STROKE INCLUDING THE STOP TUBE LENGTH IN THE "STROKE" CATEGORY. IN THE "SPECIAL OPTIONS" CATEGORY, SPECIFY THE STOP TUBE LENGTH.

REPLACEMENT PARTS, PACKING KITS AND LUBRICANTS ARE AVAILABLE FOR ALL FLAIRLINE CYLINDERS

All specifications and dimensions are subject to change without notice.

CHECK VALVES

O-CHECK®
SERIES CV

Lightweight aluminum O-Check® features a dilating O-ring as the only moving part. Quick to open, quick to close, O-Check 'out-flows' the competition, will last millions of cycles (factory tests to 50 million cycles show no discernible wear) and always provides positive sealing (no bubble leakage). Standard NPTF sizes 1/8", 1/4", 3/8", 1/2" and 3/4".

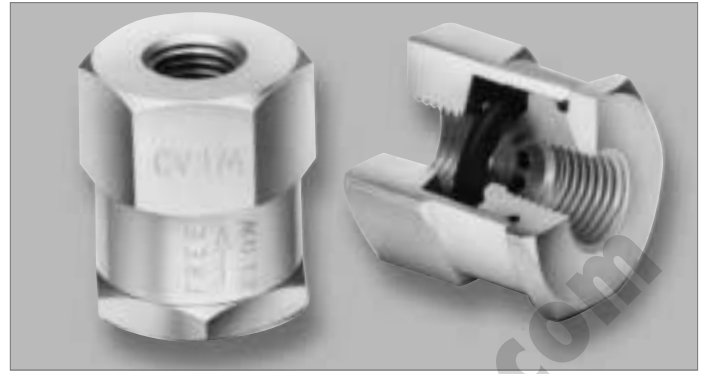
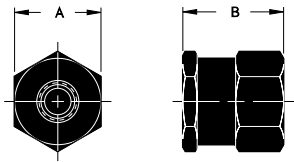
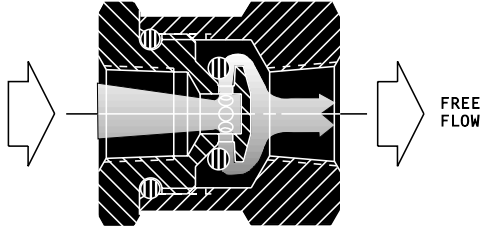

Model No.	Pipe Thread	A	B
CV-1/8	1/8-27	3/4	15/16
CV-1/4	1/4-18	1 1/8	1 5/16
CV-3/8	3/8-18	1 1/8	1 5/16
CV-1/2	1/2-14	1 5/8	1 9/16
CV-3/4	3/4-14	1 7/8	2 2/16

FLOW CONTROLS

RIGHT ANGLE FLOW CONTROL
SERIES RFC

Flairline right angle flow controls incorporate O-Check as the bypass valve. RFC permits full free flow in one direction, accurately metered flow in opposite direction. Standard metering needle design includes compound needle taper of 5° and 15° and fine adjustment stem threads (RFC 1/4 for example is 1/4"-36). Right angle design eliminates the need for pipe ell normally used to make 90° turn at cylinder port. Standard NPTF sizes 1/8", 1/4", 3/8", 1/2" and 3/4". Adjustment knobs and panel mounting available (NPTF sizes 1/8", 1/4" and 3/8" only). Optional swivel connector allows "direct" cylinder mounting and 360° rotation for ease of installation and space saving (NPTF sizes 1/8", 1/4", 3/8", and 1/2" only).

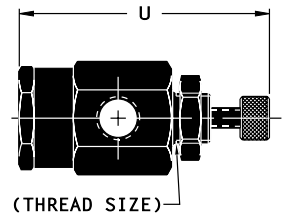
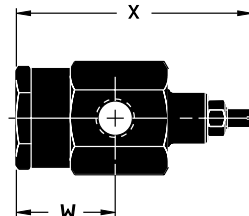
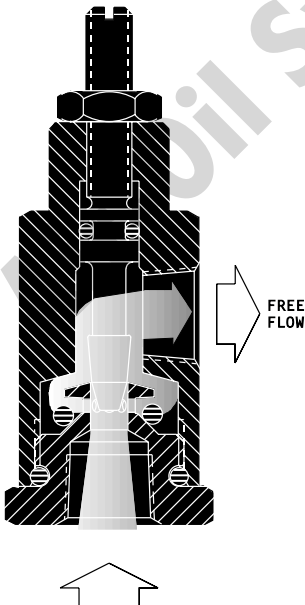
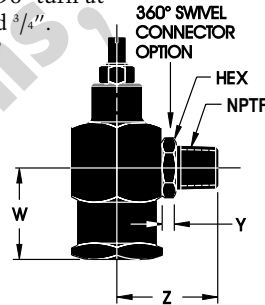

Right Angle Flow Control Model RFC-(NPTF)								
NPTF	T	U	V	W	X	Y	Z	HEX
1/8	1/2-20	27/16	3/4	7/8	2 1/8	.13	.91	1/2
1/4	5/8-18	3 3/16	1 1/4	1 1/4	3	.15	1.34	3/4
3/8	5/8-18	3 3/16	1 1/4	1 1/4	3	.15	1.34	3/4
1/2			1 5/8	1 5/8	3 3/4	.28	1.84	7/8
3/4			2	1 1/4	3 3/4			

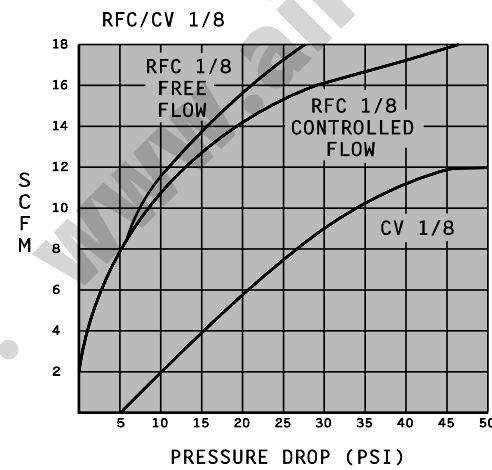
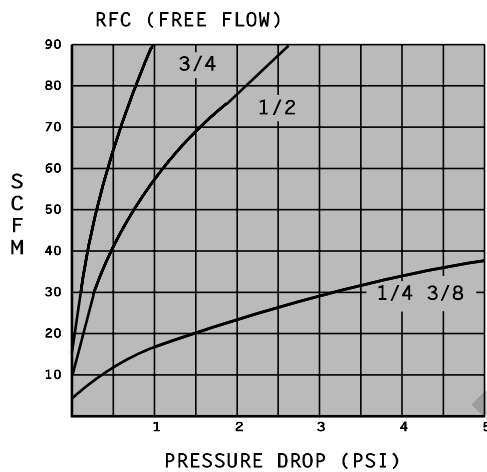
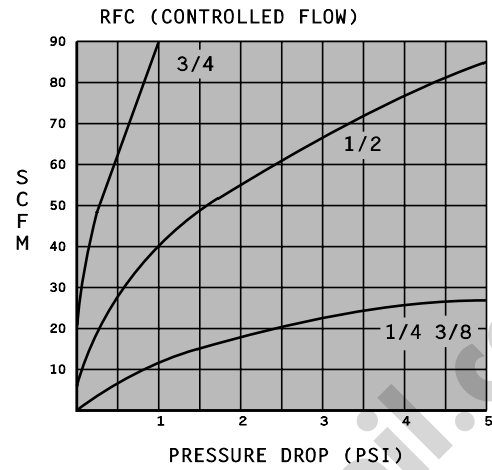
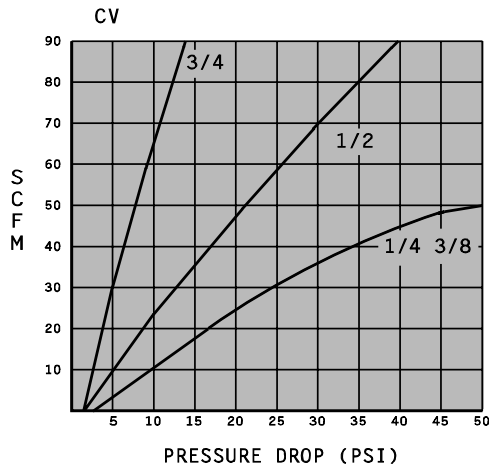

SPECIFICATIONS

Operating Pressure: 250 psi
 Operating Temperature Range: -40° - +225°F.
 Standard O-Ring Material: Buna-N (Viton available on 1/8", 1/4" and 3/8" NPTF models)
 Standard Valve Body Material: Aluminum
 Standard Needle Material: Brass
 Standard Swivel Connector Material: Zinc-Plated Steel

FEATURES

- Flairline Valves' compact design add to the appearance of any type of equipment.
- All Flairline Valves are individually tested before they leave the factory.
- Tests up to 50 million cycles show no discernible wear and still perform "bubble-tite."

ORDERING INSTRUCTIONS

EXAMPLE:

SERIES	CODE	NPTF	OPTIONS	CODE	O-RINGS	CODE
O-Check	CV	1/8 to 3/8			Buna-N (Standard) Viton	V
		1/2 and 3/4			Buna-N (Only)	
Right Angle Flow Control	RFC	1/8 to 3/8	Knob Panel Mount Knob & Panel Mt. Swivel Swivel & Knob	K P PK S SK	Buna-N (Standard) Viton	V
		1/2	Swivel	S	Buna-N (Only)	
		3/4				

All specifications and dimensions are subject to change without notice.

Air-Oil Systems, Inc. www.airoil.com

A flair for economy and availability.

FLAIRLINE[®]

23435 Industrial Park Drive Farmington Hills, MI 48335-2855 (248) 478-3330 Fax: (248) 478-3321
Website: www.flairline.com E-Mail: flairline@acecontrols.com