

NUMATICS®

G3 Series EtherNet/IP™ Technical Manual

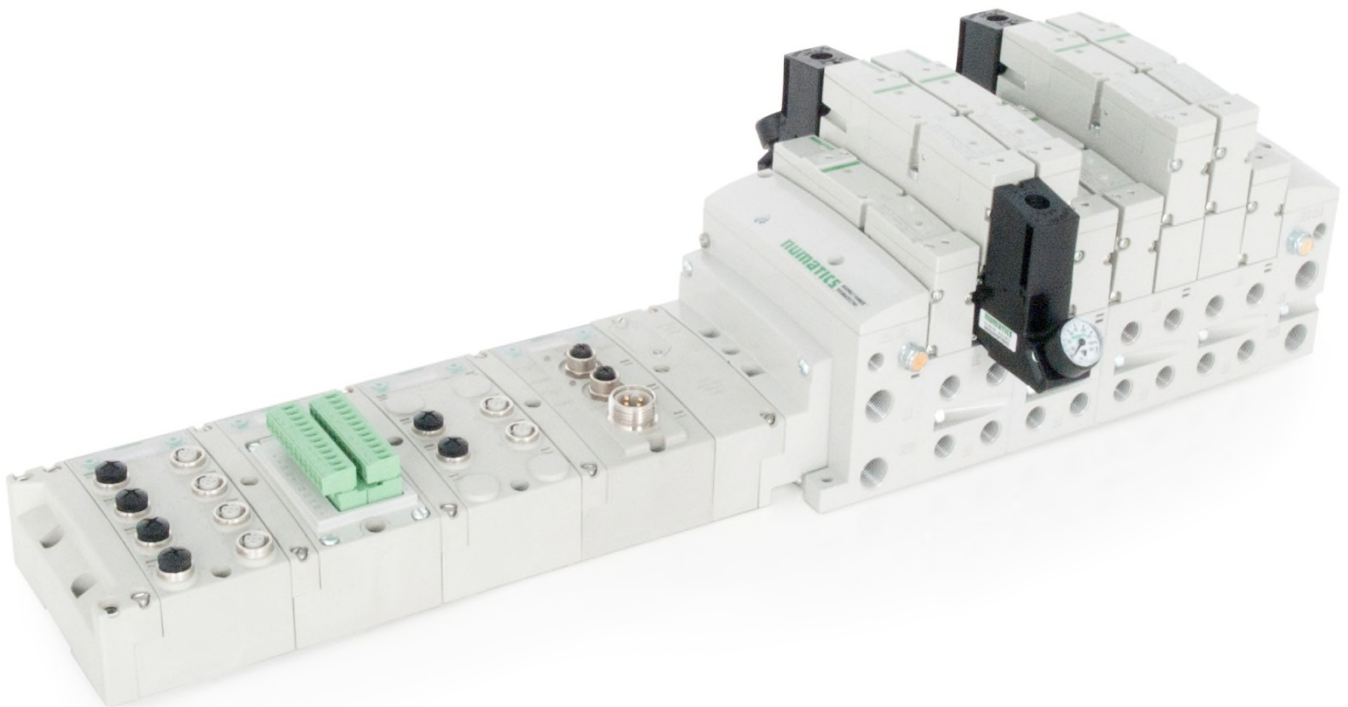

EtherNet/IP™
conformance tested



Conditions for use of this product

(1) ASCO Numatics G3 Manifold ("the PRODUCT") shall be used in conditions;

i) Where any problem, fault or failure occurring in the PRODUCT, if any, shall not lead to any major or serious accident.

ii) Where the backup and fail-safe function are systematically or automatically provided outside of the PRODUCT for the case of any problem, fault or failure occurring in the PRODUCT.

(2) The PRODUCT has been designed and manufactured for the purpose of being used in general industries.

ASCO Numatics shall have no responsibility or liability including but not limited to any and all responsibility or liability based on contract, warranty, tort, product liability for any injury or death to persons, loss or damage to property caused by the product that are operated or used in application not intended or excluded by instructions, precautions or warnings contained in ASCO Numatics Technical, User, Instruction, Safety manuals or bulletins.

Safety precautions

Before using this product, please read this manual and the relevant manuals carefully and pay attention to safety and product application. The following symbols are used in the manual to identify important safety, installation and application information.



CAUTION

Caution symbol indicates a possible hazard which may cause injury or equipment damage.



Note symbol indicates important information regarding equipment installation and setup



CAUTION

Electrical installation and operational guidelines

- *To be connected to Class 2 power source only.*
- *All ASCO Numatics communication nodes should be grounded during the installation process. These grounding guidelines can be found in National Electrical code IEC 60204-1 or EN 60204-1.*
- *All ASCO Numatics G3 Electronics Products to be installed or wired in accordance with ASCO Numatics' published instructions and applicable electrical codes.*
- *MULTIPLE CLASS 2 POWER SOURCES: When interconnects, class 2 sources shall be Listed and rated suitable for parallel interconnection.*
- *Sources shall be Listed and rated suitable for parallel interconnection.*
- *CLASS 2 WIRING: All field wiring shall be suitable for Class 1, Electric Light and Power, or Class 2, 3 wirings are routed separately and secured to maintain separation between 1) Class 2 wiring and all other class wiring, and 2) Limited energy circuit conductors from unlimited energy circuit conductors.*
- *Class 2 Device Wiring Only – Do Not Reclassify and Install as Class 1, 3 or Power and Lighting Wiring.*
- *When using molded connector power cables, Do Not rely on wire colors for Pin-Out. Always use pin number references.*
- *Wire connections shall be rated suitable for the wire size (lead and building wiring) employed.*
- *MULTIPLE CLASS 2 POWER SOURCES: When interconnects, class 2 sources shall be Listed and rated suitable for parallel interconnection.*
- *Sources shall be Listed and rated suitable for parallel interconnection.*

Table of Contents

1. About EtherNet/IP™	1-6
1.1 Overview	1-6
1.2 G3 EtherNet/IP™ Features	1-6
1.3 G3 EtherNet/IP™ Performance Data	1-6
2. G3 Introduction	2-7
2.1 G3 Electronics Modularity.....	2-8
2.2 500 Series Pneumatic Valve Manifold	2-9
2.3 500 Series Manifold Stations	2-10
2.4 500 series Z-Board™ Connectors	2-11
2.5 2000 Series Pneumatic Valve Manifold.....	2-12
2.6 2000 Series Z-Board™ Connectors.....	2-13
2.7 2000 Series Z-Board™ and Ribbon Cable Example	2-14
2.8 2000 Series Z-Board™ and Valve Side Sub-D Example	2-15
3. Zoned Power	3-16
3.1 503 Series Zoned Power application	3-16
3.2 503 Series Zoned Power example	3-17
4. Communication Module	4-18
4.1 EtherNet/IP™ Communication Module (Node).....	4-18
4.2 Communication Module Description.....	4-19
4.3 Connector Pin-Outs	4-20
4.4 Electrical Connections.....	4-21
4.5 Ground Wiring	4-23
4.6 Power Consumption	4-24
4.7 Diagnostics	4-26
5. G3 Graphic Display	5-28
5.1 Main Menu Structure	5-29
5.2 IP Address	5-30
5.3 Subnet Mask	5-31
5.4 Gateway IP	5-32
5.5 DHCP-BOOTP	5-33
5.6 Web-Server	5-34
5.7 MAC Address.....	5-35
5.8 Advanced Settings - I/O Diag. Menu.....	5-36
5.9 Advanced Settings – Node Diagnostics (Diagnostic Word).....	5-37
5.10 Advanced Settings – Comm. Fault.....	5-38
5.11 Advanced Settings - Brightness	5-39
5.12 Advanced Settings – Flip Display	5-40
5.13 Advanced Settings – Parameters Lock	5-41
5.14 Advanced Settings – Configuration Lock	5-42
5.15 Factory Defaults	5-43
5.16 Diagnostics	5-44
5.17 Diagnostics - Self Test Mode	5-45
5.18 Error Messages.....	5-46
6. ARM – Auto Recovery Module (Optional)	6-47
6.1 ARM process flowchart.....	6-48
7. Distribution	7-49
7.1 Sub-Bus Distribution Modules.....	7-50
7.2 Sub-Bus Cables	7-56
8. Digital I/O Module	8-58
8.1 Digital I/O Module Usage	8-58
8.2 I/O Module Technical Data	8-59
8.3 I/O Module Descriptions and Menus.....	8-60
8.4 Digital Input Modules	8-61
8.5 Digital Output Modules	8-69
8.6 Digital Input/Output Modules	8-73
8.7 Sub-bus Valve Module	8-76
8.8 Sub-bus Valve Module without Distribution and I/O.....	8-78
8.9 Valve Side Digital Output Module	8-79
9. Analog I/O Modules	9-80
9.1 Analog I/O Module Rules.....	9-80
9.2 Analog Graphic Display.....	9-84

numatics G3 Series EtherNet/IP™ Technical Manual

9.3	Analog Module / Self Test Mode	9-87
9.4	Analog Module / Factory Defaults	9-88
10.	Specialty Modules	10-89
10.1	RTD Module	10-89
10.2	Sub-Bus Hub Module	10-100
11.	I/O Module Wiring Diagrams	11-108
11.1	NPN/PNP Definitions	11-108
12.	EtherNet/IP™ G3 Web Server	12-110
12.1	Integrated Web Page Configuration	12-110
12.2	Connecting to a G3 Series EtherNet/IP™ Node (Windows 7)	12-110
12.3	Connecting to a G3 Series EtherNet/IP™ Node (Windows 10)	12-115
12.4	EtherNet/IP™ Web Server functionality	12-120
12.5	IP Address Configuration	12-129
12.6	Configuration with RSLogix 5000	12-130
12.7	User Configurable Device Parameters	12-132
12.8	Communication Fault/Idle Mode Parameter	12-133
13.	EtherNet/IP™ Mapping	13-134
13.1	I/O Sizes	13-134
13.2	Manifold and I/O Data Sizing Worksheet	13-135
13.3	Bit Mapping Rules	13-136
13.4	Example No. 1	13-137
13.5	Example No. 2	13-139
13.6	Example No. 3	13-141
13.7	Example No. 4	13-143
13.8	Example No. 5	13-145
13.9	I/O Mapped Diagnostic Word	13-147
14.	Appendix	14-149
14.1	System Specifications	14-149
14.2	Factory Default Settings	14-150
14.3	Troubleshooting	14-151
14.4	Glossary of Terms	14-152
14.5	Technical Support	14-154

numatics G3 Series EtherNet/IP™ Technical Manual

1. About EtherNet/IP™

1.1 Overview

EtherNet/IP™ is a communication protocol that uses the same network technology that can be found in commercial and domestic operations worldwide, but has added benefits/features toward manufacturing applications. It is a CIP (common industrial protocol) Network that follows the Open Systems Interconnection (OSI) model.

The ODVA (Open DeviceNet Vendor Association) is an independent organization that governs the EtherNet/IP™ specification and oversees conformance testing for products.

EtherNet/IP™ uses industrial M12 IP67-rated connectors. The protocol can transfer data at two interface speeds of 10 Mbps and 100 Mbps. Maximum network cabling distance is limited to 100m segments at 20° C.

More information about EtherNet/IP™ and ODVA can be obtained from the ODVA web site www.odva.org.

1.2 G3 EtherNet/IP™ Features

<i>Features</i>	<i>Description</i>
EtherNet/IP™ Spec. Supported	Designed to EtherNet/IP™ Specification
Bus Topology	Star and Multi-Star
Baud Rates Supported	10/100 Mbps and Autobaud
CE	CE Compliant
Duplicate Address Detection	If a duplicate address is detected on power up, duplicates will not progress to run mode
Address Setting	Via DHCP/BOOTP, Web Page Configuration, or Graphical Display
Duplex	Half and Full supported
Conformance Tested	Tested by ODVA for conformance
Protocols supported	ACD, ARP, DHCP, HTTP, TCP/IP, UDP

1.3 G3 EtherNet/IP™ Performance Data

<i>Features</i>	<i>Description</i>
CIP connections consumed	1
CIP connections available	16
Packets per second (PPS)	10,000
RPI	≥ 5ms
Connection Type	Multicast, Unicast

2. G3 Introduction

The G3 Series is an electronic product platform that features an integrated graphic display for simple commissioning and displaying of diagnostic information. In addition, it has an innovative distribution capability which allows the same I/O components that make up a centralized manifold configuration to be used as the distribution components as well, decreasing the need for duplicate components on centralized and distributed applications. The G3 platform interfaces to a variety of valve series and fieldbus interface protocols and is capable of addressing a total of 1200 I/O points (150 bytes). With proper assembly and termination, the G3 modules will have an IP65 / IP67 rating.

The manifold can be viewed as having two sections to it, the *Valve Side* and the *Discrete I/O Side*. The *Valve Side* supports a maximum of 32 solenoid coils and the *Discrete I/O Side* supports a maximum of 16 modules capable of addressing up to 1200 outputs, 1200 inputs or various combinations.

Various discrete modules with integrated graphic display are available. They include digital I/O, analog I/O, and specialty modules which cover various application needs. Pin-outs for all connectors are labeled on the side of the respective modules and are also detailed in the module section of this document.

This manual details specific information for configuring and commissioning the ASCO Numatics G3 Series product line. For more information relating to pneumatic valves and valve manifold assemblies, please refer to the Numatics "In Control" catalog at www.asco.com.

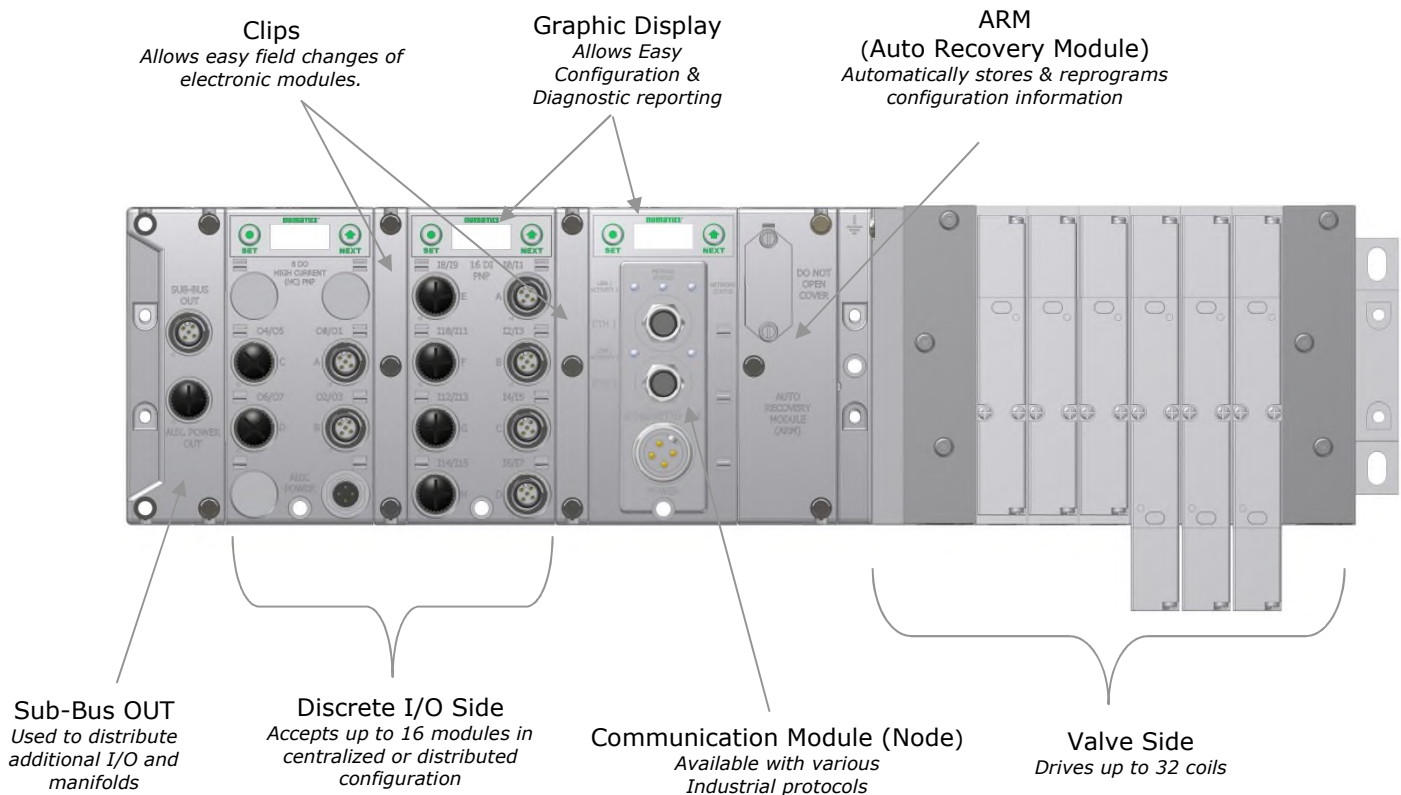

numatics G3 Series EtherNet/IP™ Technical Manual

2.1 G3 Electronics Modularity

Discrete I/O

The G3 Series product line is a completely modular and scalable system. As shown below, all of the G3 electronic modules plug together, via mechanical clips, allowing for easy assembly and field changes.

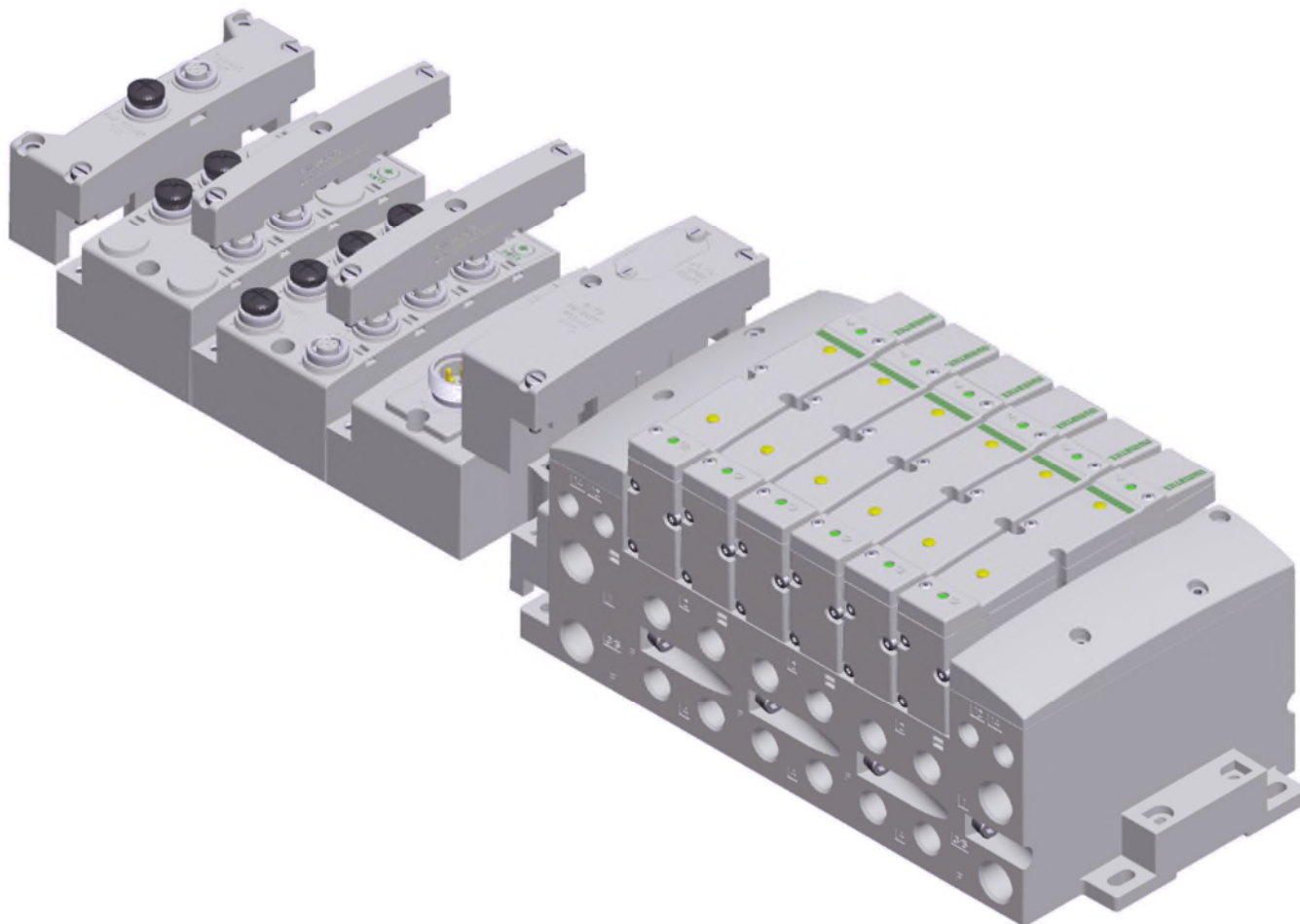

NUMATICS G3 Series EtherNet/IP™ Technical Manual

2.2 500 Series Pneumatic Valve Manifold

The pneumatic valve manifold with internal circuit board technology is also modular. The valve solenoid coil connections are automatically made using Z-Board™ technology (plug together PC boards), which allow internal connection from solenoid coils to output drivers without the use of wires. This allows easy assembly and field changes.

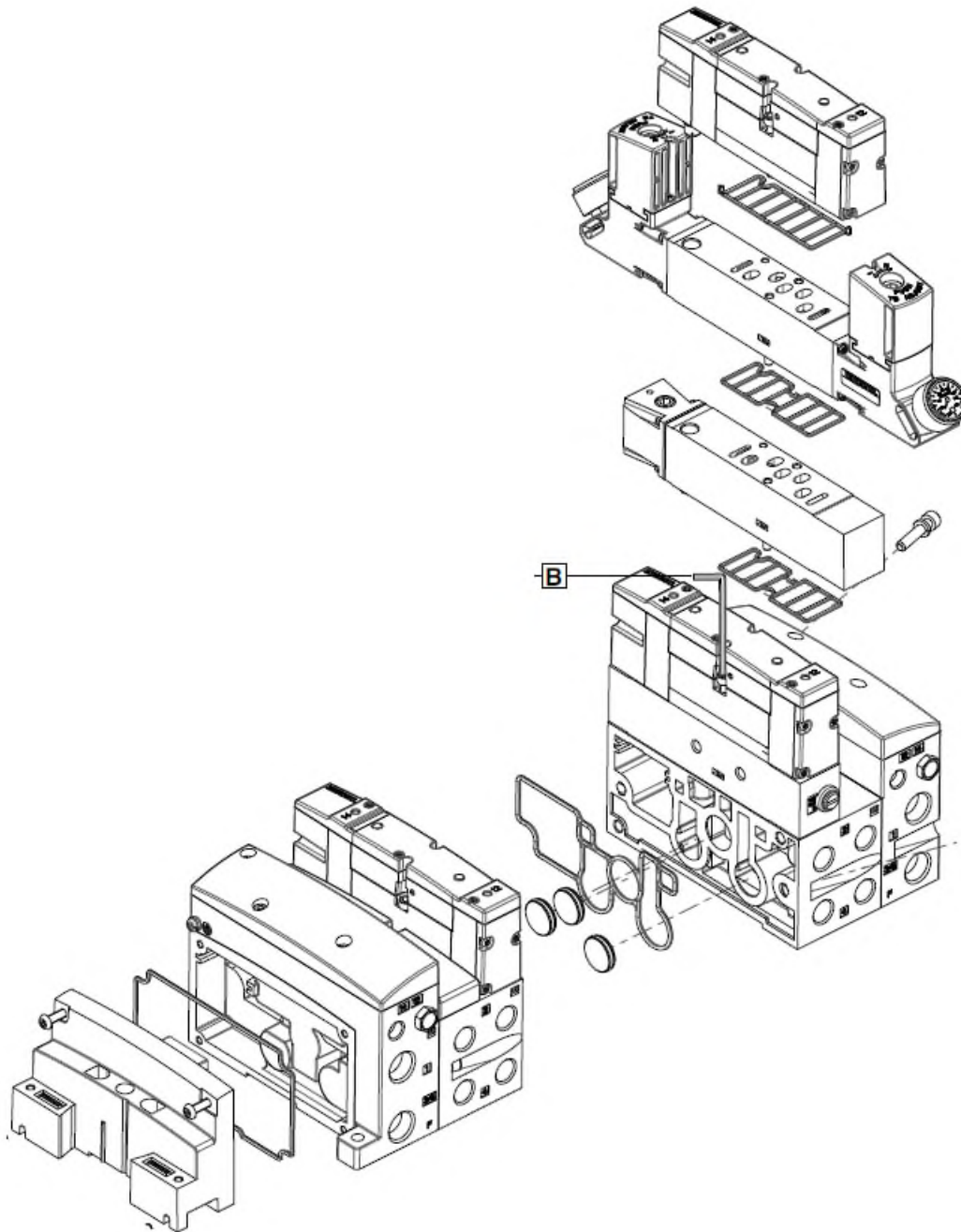

numatics G3 Series EtherNet/IP™ Technical Manual

2.3 500 Series Manifold Stations

Solenoid Coil Connections using Z-Board™ Technology for 501/502/503 valve series

Z-Board™ plug-together technology connects all valve solenoids to the valve coil output driver board, located in the valve adapter. There is a maximum of 32 coil outputs available on the complete manifold assemblies. The 32 available outputs are accessed on the 501 series valves utilizing 4 station manifolds and on the 502 and 503 series utilizing 2 station manifolds.

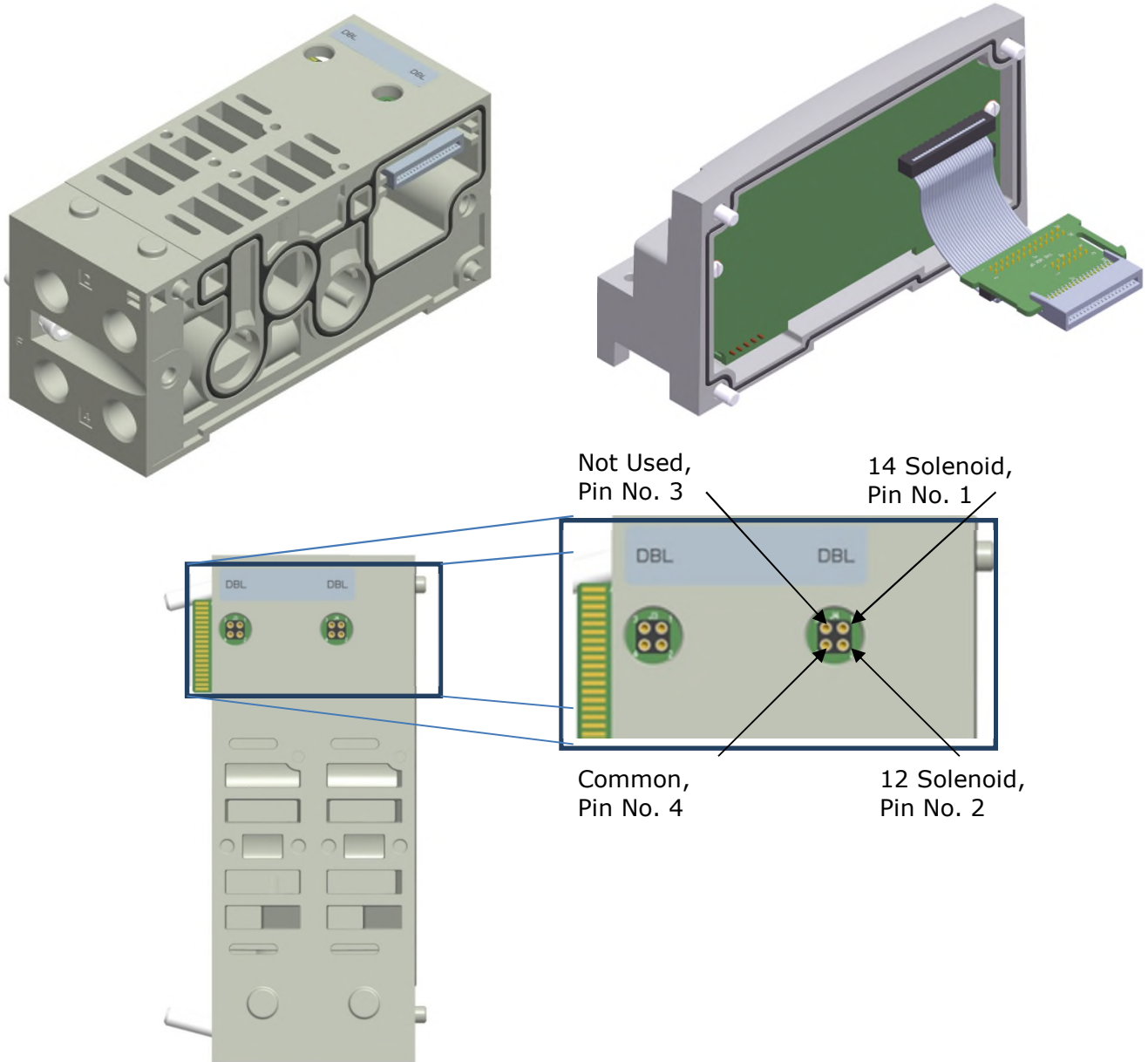

A single solenoid valve's coil is always on the "14" end.

NUMATICS™ G3 Series EtherNet/IP™ Technical Manual

2.4 500 series Z-Board™ Connectors

The 501, 502 and 503 valve series utilize 2 different Z-Board™ designs to achieve the single and double solenoid output functions. This yields the possible 32 single, 16 double, or various combinations of valve coil output capabilities.

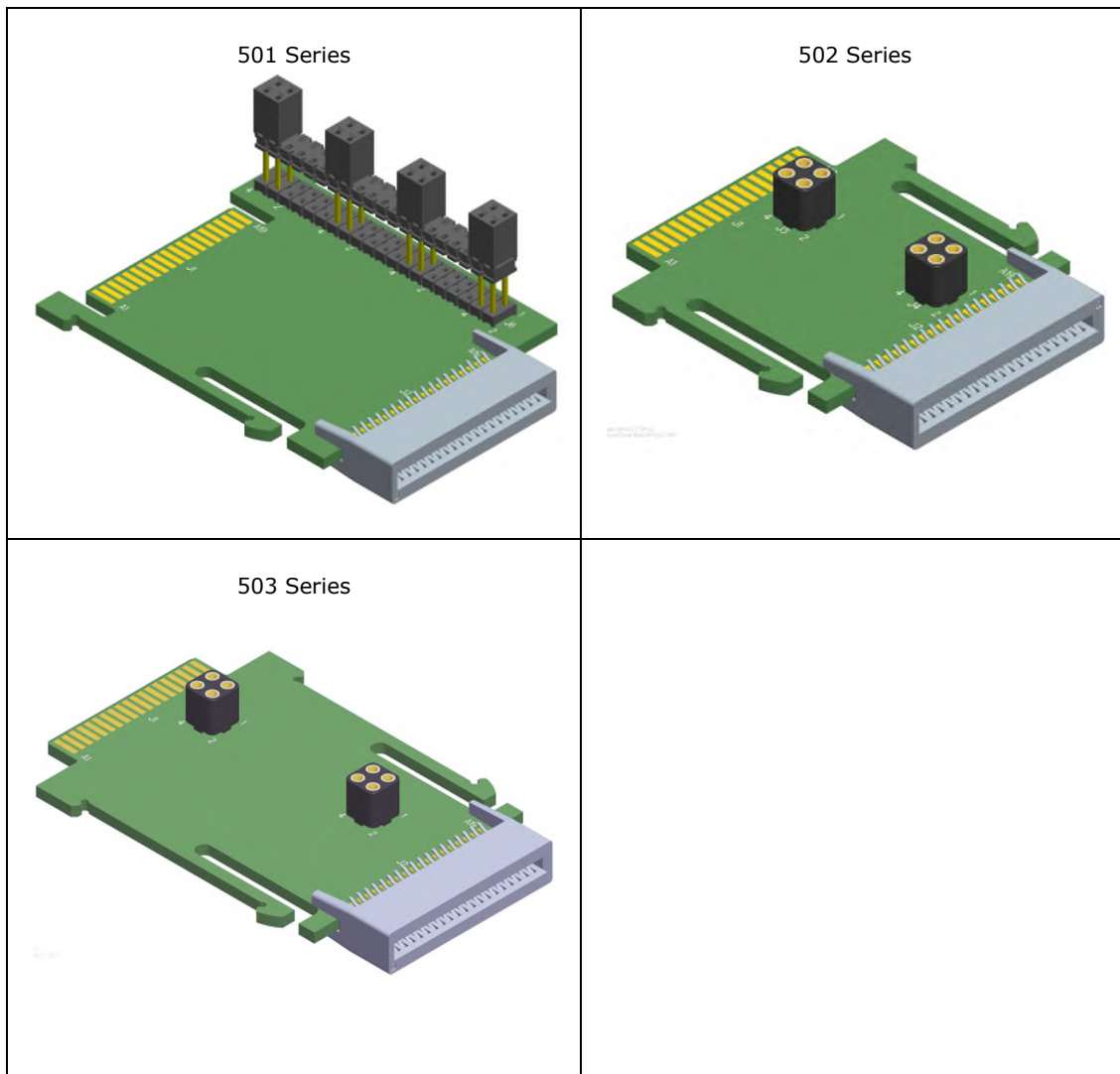

NUMATICS[®] G3 Series EtherNet/IP[™] Technical Manual

2.5 2000 Series Pneumatic Valve Manifold

The pneumatic valve manifold with internal circuit board technology is also modular. The valve solenoid coil connections are automatically made using Z-Board[™] technology (plug together PC boards), which allow internal connection from solenoid coils to output drivers without the use of wires). This allows easy assembly and field changes.

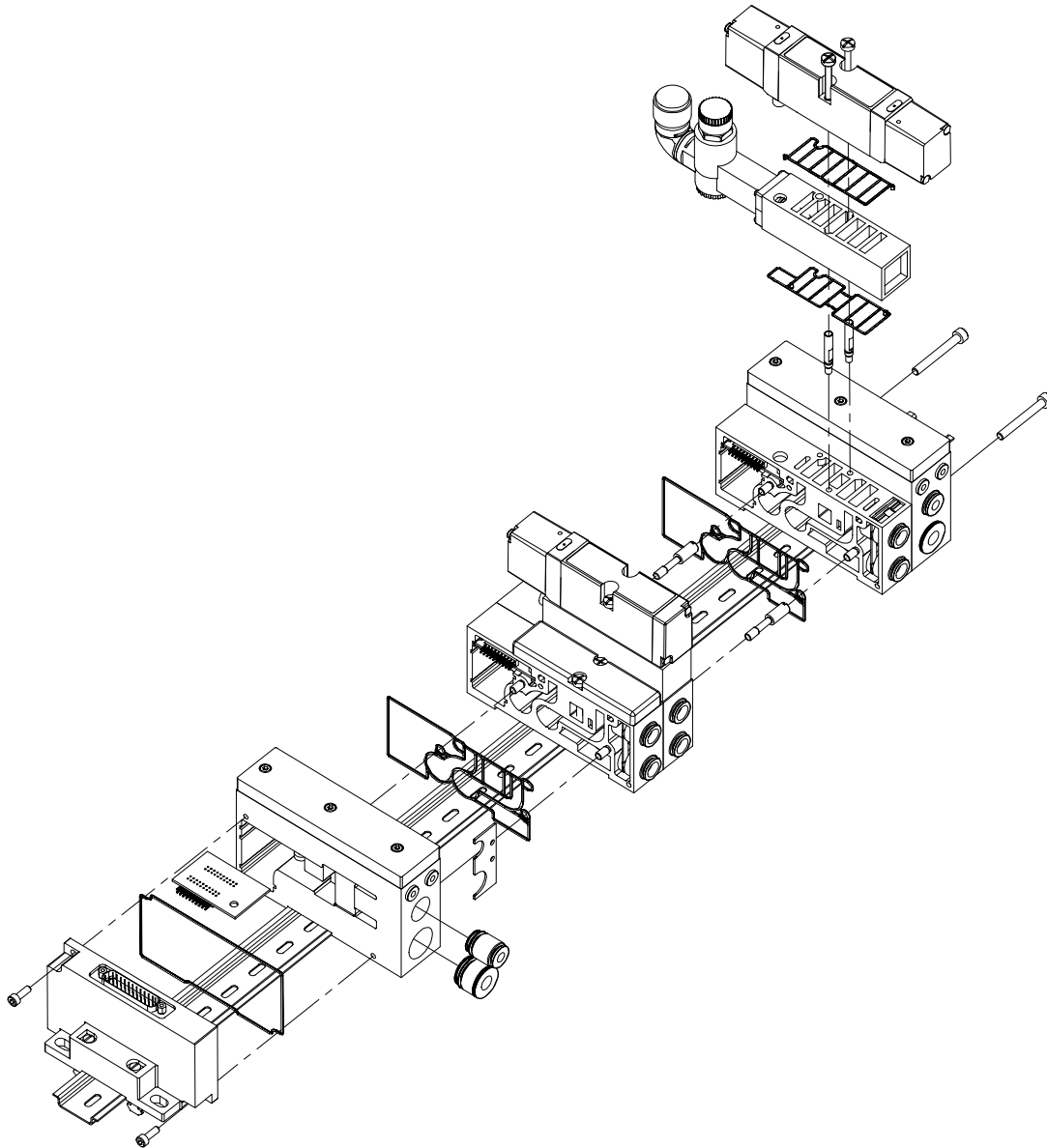

numatics G3 Series EtherNet/IP™ Technical Manual

2.6 2000 Series Z-Board™ Connectors

The 2005/2012/2035 valve series utilize 2 different Z-Board™ designs to achieve the single and double solenoid output functions. This yields the possible 32 single, 16 double, or various combinations of valve coil output capabilities.

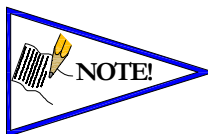
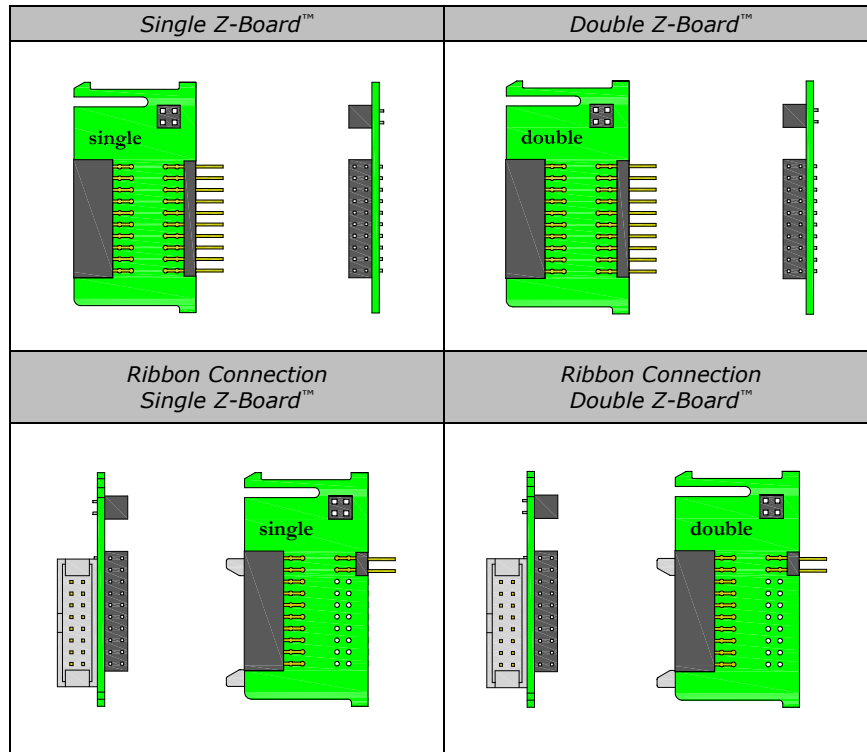

The 17th solenoid (output group No. 2's first bit) must be accessed via either the valve side Sub-D output module or a ribbon connector type Z-board.

numatics G3 Series EtherNet/IP™ Technical Manual

2.7 2000 Series Z-Board™ and Ribbon Cable Example

If fourteen (14) single solenoid and one (1) double solenoid valves are connected directly to the communication node via their Z-Boards™, and one (1) single solenoid and four (4) double solenoid valves are connected to the communication node via the ribbon cable, the following would be the valve side bit map:

S = Single Solenoid with Single Z-Board™
 D = Double Solenoid With Double Z-Board™

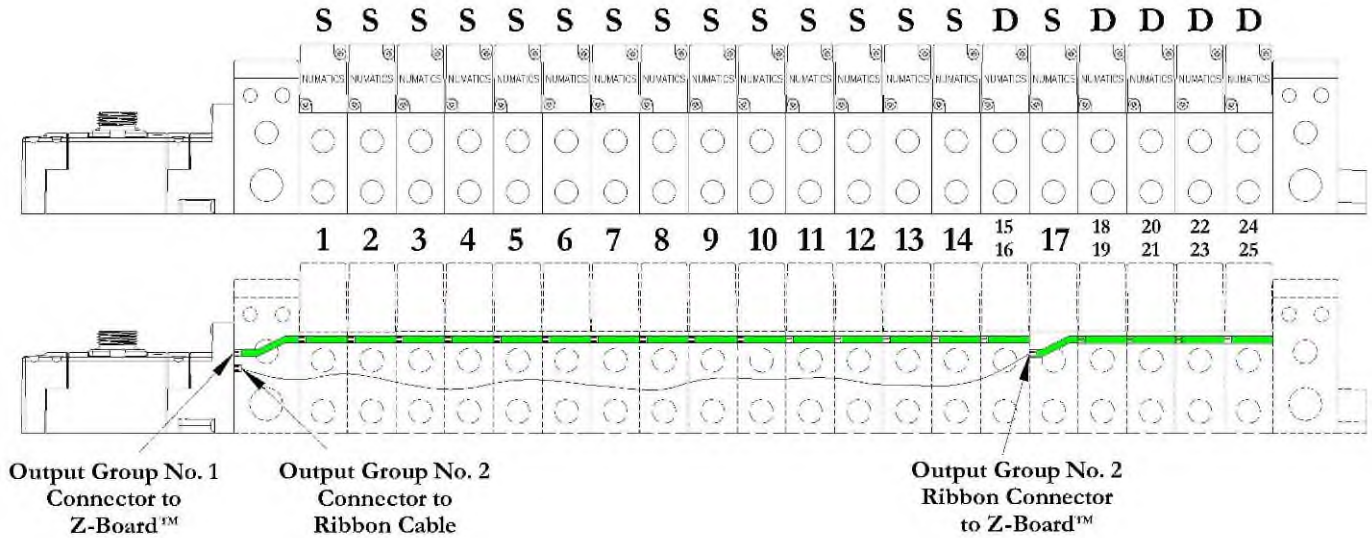

Output Word	0															1																				
Output Byte	0							1								2							3													
Output Bit No.	00	01	02	03	04	05	06	07	08	09	10	11	12	13	14	15	16	17	18	19	20	21	22	23	24	25	26	27	28	29	30	31				
Solenoid Coil Output No.	1	2	3	4	5	6	7	8	9	10	11	12	13	14	15	16	17	18	19	20	21	22	23	24	25	n/a										



The ribbon cable and valve side Sub-D examples do not apply to 501,502 or 503 series.

NUMATICS G3 Series EtherNet/IP™ Technical Manual

2.8 2000 Series Z-Board™ and Valve Side Sub-D Example

If sixteen (16) single solenoid valves are connected directly to the communication node via Z-Boards™ and a valve side Sub-D connector is connected to the communication node via the output Group No. 2 connector then the following would be the valve side bit map:

S = Single Solenoid with Single Z-Board

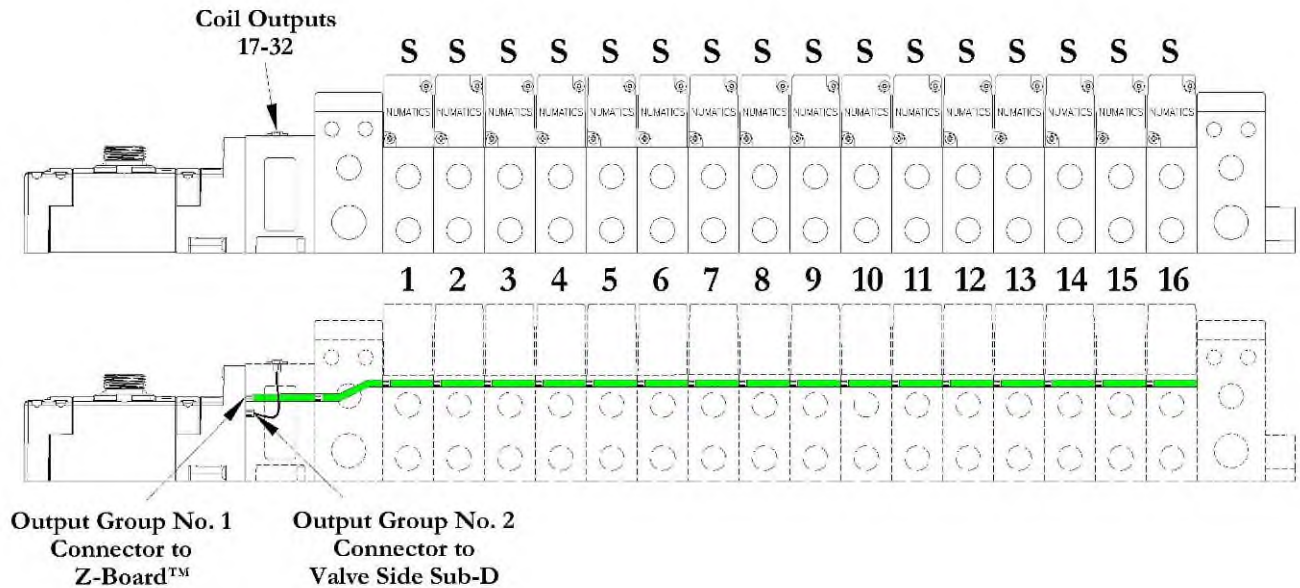

Output Word	0								1																							
Output Byte	0				1				2				3																			
Output Bit No.	00	01	02	03	04	05	06	07	08	09	10	11	12	13	14	15	16	17	18	19	20	21	22	23	24	25	26	27	28	29	30	31
Solenoid Coil Output No.	1	2	3	4	5	6	7	8	9	10	11	12	13	14	15	16	17	18	19	20	21	22	23	24	25	26	27	28	29	30	31	32

3. Zoned Power

3.1 503 Series Zoned Power application

The Zoned Power Manifold blocks can be incorporated into a 503 Series manifold assembly to isolate Power to a number of valve stations, independent from the main power of the manifold. This is achieved by the integral 4-Pin M12 connector along with the modified manifold board. The total number of Zoned Power Manifold blocks is determined by the maximum solenoid outputs as defined by the type of interface (e.g. G3 Electronics, Terminal Strip, D-Sub). For user flexibility, the Zoned Power Manifold blocks are available in both "proprietary" and "ISO" versions and can be ordered with the M12 connector starting at the first or second station.

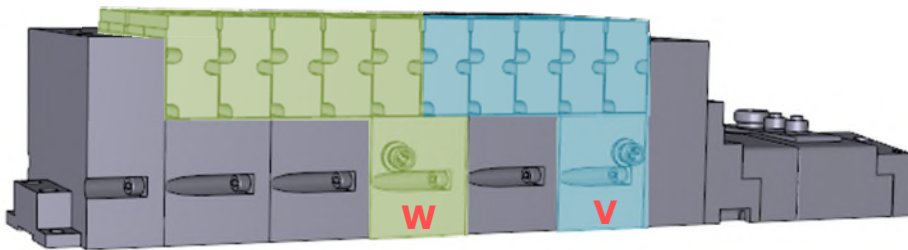

V Wiring Option

W & V Connector Pin Out

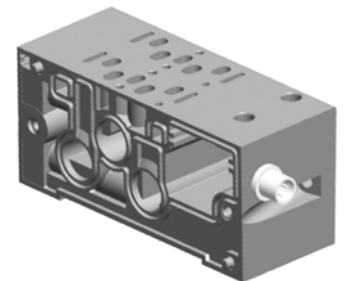
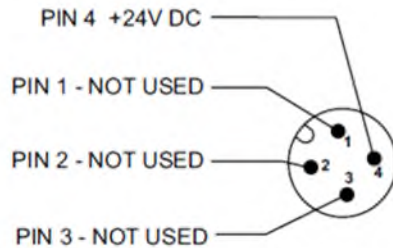

W Wiring Option

Technical Data

Electrical Data:

Voltage:	24 VDC (0 VDC must be common with main power)
Connection:	4-Pin M12 Single Key Male
Environmental:	IP65 (with proper connection)

numatics G3 Series EtherNet/IP™ Technical Manual

3.2 503 Series Zoned Power example

In the example shown below there are two Zoned Power Manifold blocks used. One is a "V" wiring option and the other is a "W" wiring option. The first (5) stations of the manifold assembly get their power from the M12 4-Pin connector at station one. The next (5) stations get their power from the M12 4-Pin connector at station six. Each of these "Zones" can be individually switched off if the machine or process requires. This example is considered a manifold with (2) Power Zones. The Main Power (7/8" MINI) cannot be considered or used as a Power Zone; Switched Power (Solenoid/Output Power) **MUST** be present for control to the solenoids.

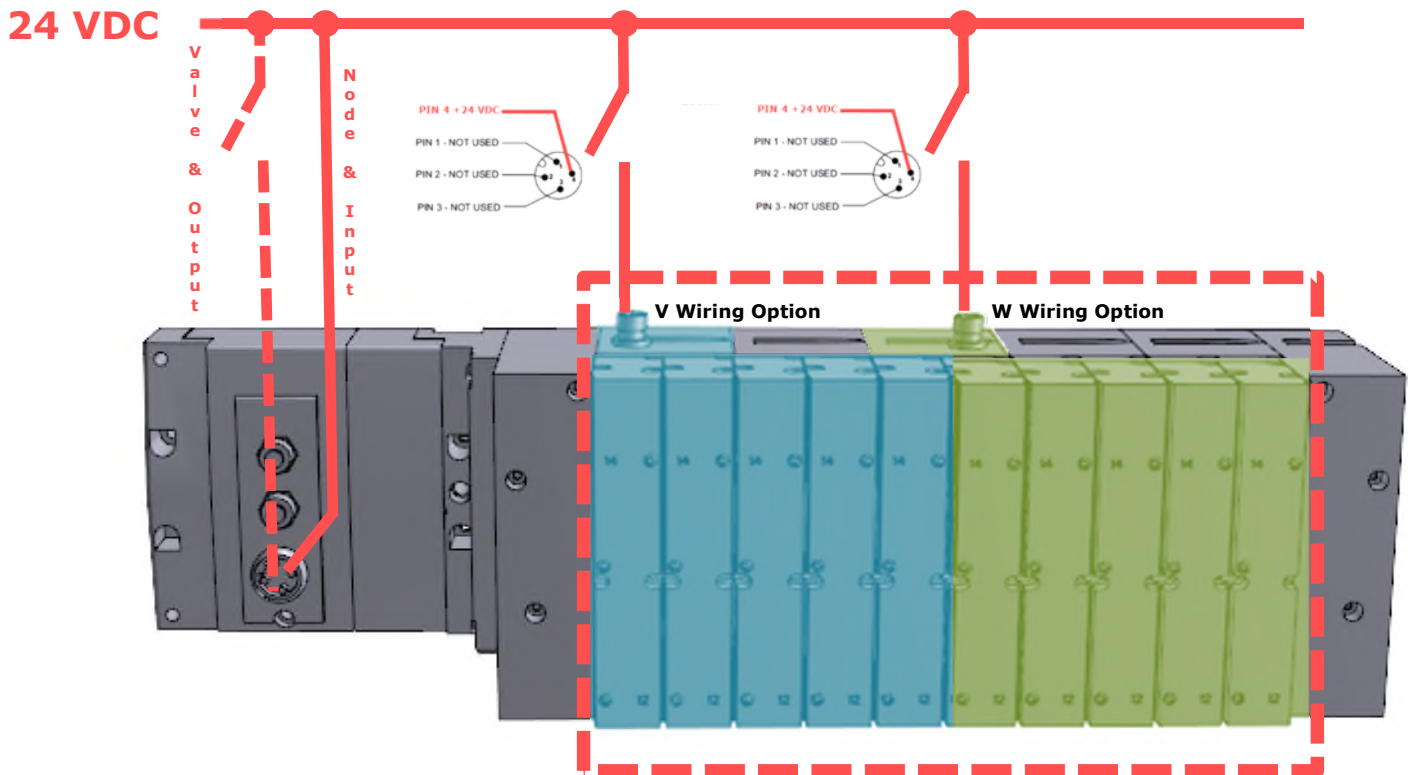

The 0 VDC reference for the +24 VDC applied to Pin 4 of the M12 connector **MUST** be the same as the one used on G3/580/Terminal Strip/25 or 37 Pin Sub-D/19 or 26 Pin Round Connector. If multiple 24 VDC power supplies are used the 0 VDC references of each supply **MUST** be common.

4. Communication Module

4.1 EtherNet/IP™ Communication Module (Node)

This module is the communication interface to the manifold. It contains communication electronics and internal short circuit protection for power. It can be configured via software, via the graphic display or manually via DIP switches through the optional Manual Configuration Module (MCM).

Communication Module Kit Part Number	
EtherNet/IP™ Communication Module	240-181



numatics G3 Series EtherNet/IP™ Technical Manual

4.2 Communication Module Description

Detail No.	Description
1	"Set" Button - used to navigate through user menus and to set parameters
2	Activity/Link Status LED
3	4 Pin M12 D-Coded Female Communication Connector
4	Mounting Hole
5	"Next" Button - used to navigate through user menus and to set parameters
6	Graphic Display - used to display parameter information
7	Network Status LED
8	Slot for text ID tags
9	Keying for preventing I/O module insertion
10	4 Pin MINI Male Power Connector

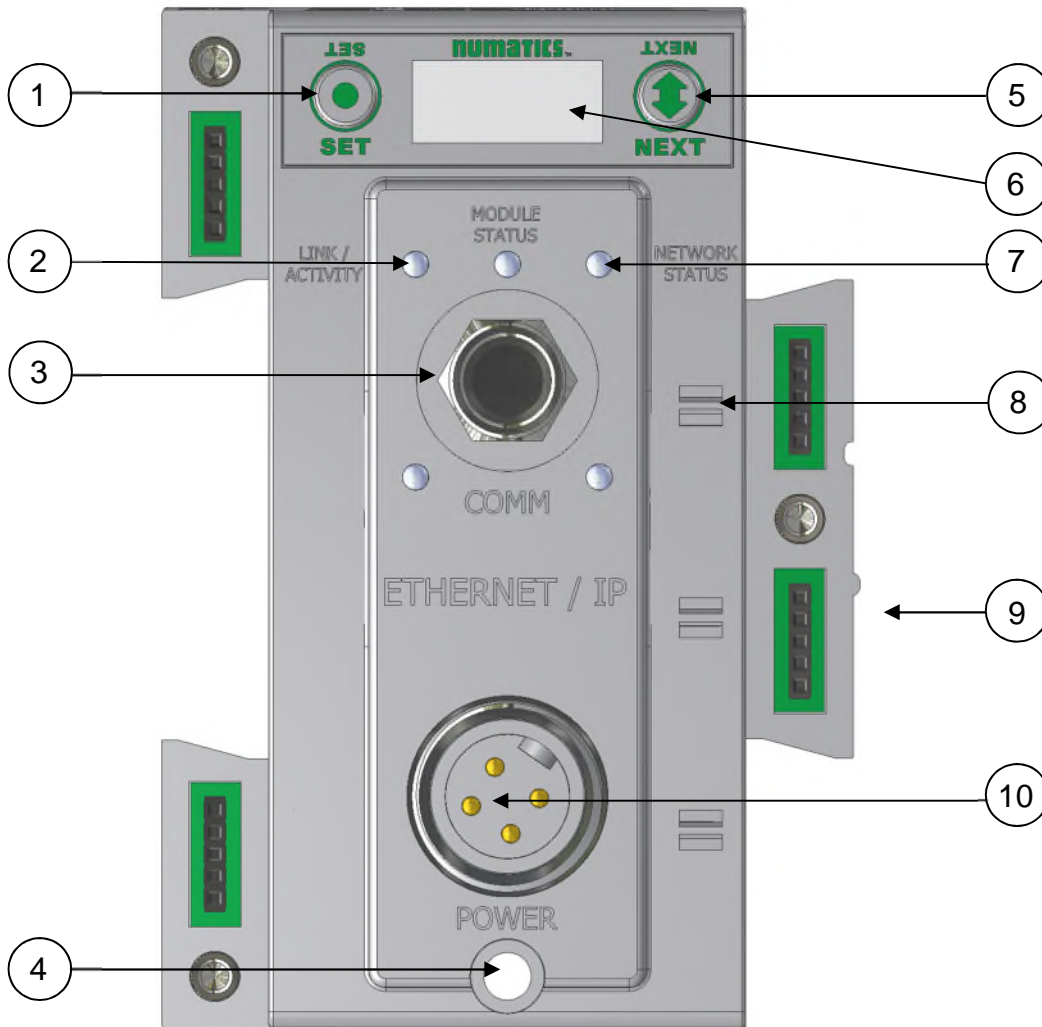

NUMATICS G3 Series EtherNet/IP™ Technical Manual

4.3 Connector Pin-Outs

Industry standard connectors are used for communication and auxiliary power. The EtherNet/IP™ communication connector is a D-coded keyway 4 pin female M12 connector. The Power connector is a single keyway 4-pin male 7/8" MINI connector.

EtherNet/IP™ Communication Connector Pin-Out

Pin No.	Function	Description
1	TX+	Positive Transmit Line
2	RX+	Positive Receive Line
3	TX-	Negative Transmit Line
4	RX-	Negative Receive Line

Power Connector with Cenelec Pin-Out

Cenelec Pin No.	Function	Description
1	+24 VDC (Valves and Outputs)	Voltage used to power outputs (valve coils and discrete outputs) SW
2	+24 VDC (Node and Inputs)	Voltage used to power discrete inputs and node electronics UNSW
3	0 VDC (Node and Inputs)	0 VDC Voltage used to power discrete inputs and node electronics UNSW
4	0 VDC (Valves and Outputs)	0 VDC Voltage used to power outputs (valve coils and discrete outputs) SW

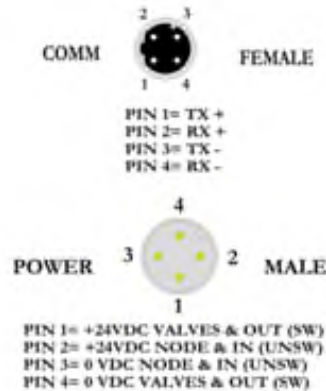

- Power common (0 VDC) pins 3 and 4 are isolated from each other to allow separate (isolated) power supply connection if required. However, they can be tied together if a single common, non-isolated, application is preferred.
- The combined draw of the +24VDC Valves and Outputs and +24VDC Node and Inputs pins cannot exceed 8 Amps, at any given moment in time.
- The Node and Input power pin (2) supplies power to the node electronics. This pin must be powered at all times for communication node to be functional.

NUMATICS G3 Series EtherNet/IP™ Technical Manual

4.4 Electrical Connections

Power Connector Wiring Diagram

Power Supply Example (Non-isolated commons)

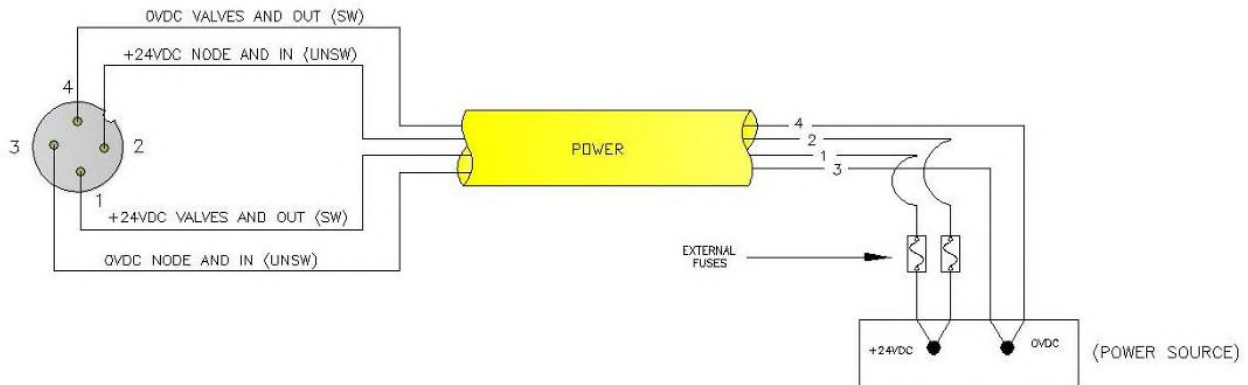

Power Supply Example (Isolated commons)

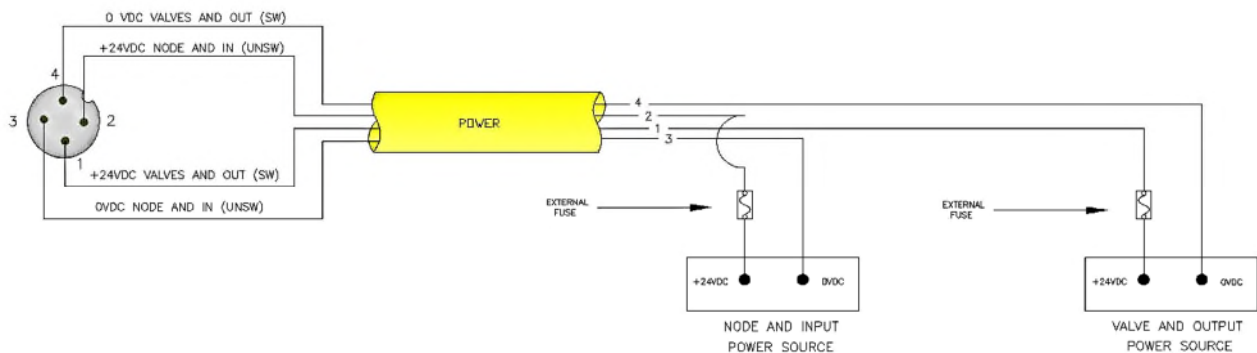

CAUTION

- Please see page 25 for external fuse sizing guide.
- When using molded connector power cables, Do Not rely on wire colors for Pin-Out. Always use pin number references.
- The combined draw of the +24VDC Valves and Outputs and +24VDC Node and Inputs pins cannot exceed 8 Amps, at any given moment in time.

numatics G3 Series EtherNet/IP™ Technical Manual

EtherNet/IP™ Straight-Through Cabling Diagrams

Straight-Through Ethernet cable is used when connecting an Ethernet node to a basic media component (router, switch, hub, etc.). Here are some basic wiring examples of Straight-Through cabling.

RJ45 to M12 D Coded Cable

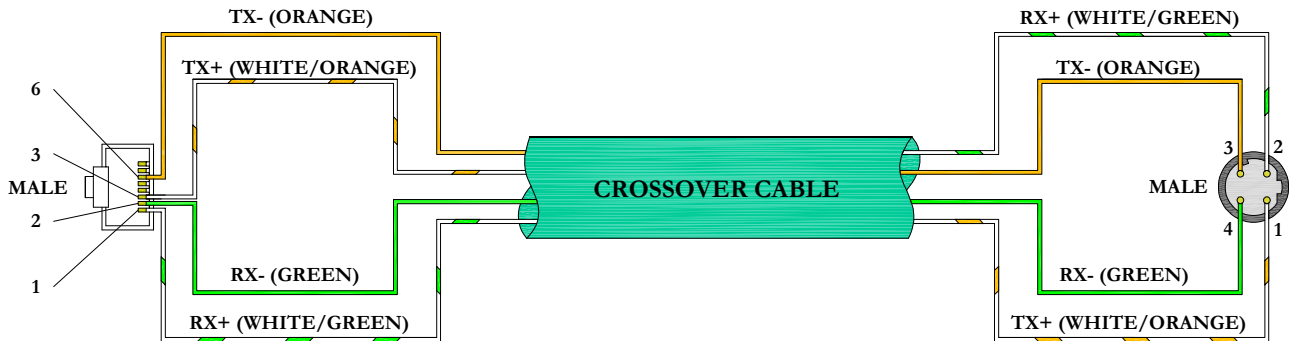

M12 D Coded to M12 D Coded Cable

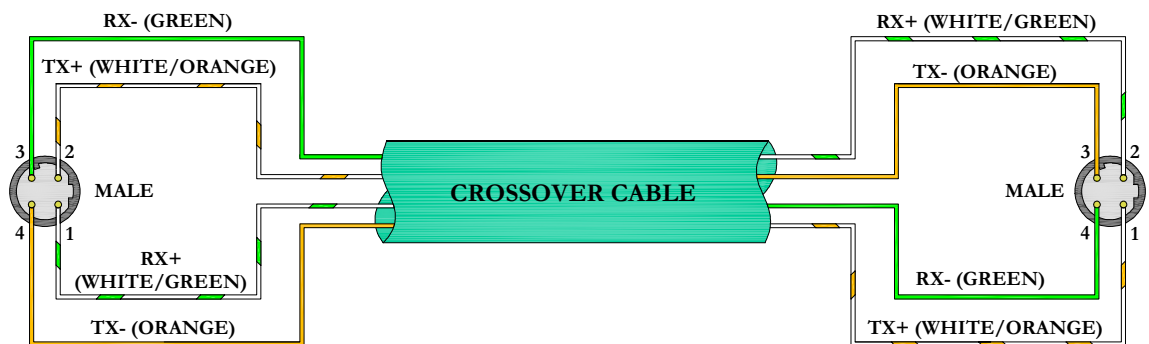

- These are examples only. For appropriate network cabling information, please see the ODVA document titled, "EtherNet/IP™: Media Planning and Installation Manual".
- RJ45 shown as T-568B standard.

NUMATICS G3 Series EtherNet/IP™ Technical Manual

4.5 Ground Wiring

All ASCO Numatics communication nodes should be grounded during the installation process. These grounding guidelines can be found in National Electrical code IEC 60204-1 or EN 60204-1.

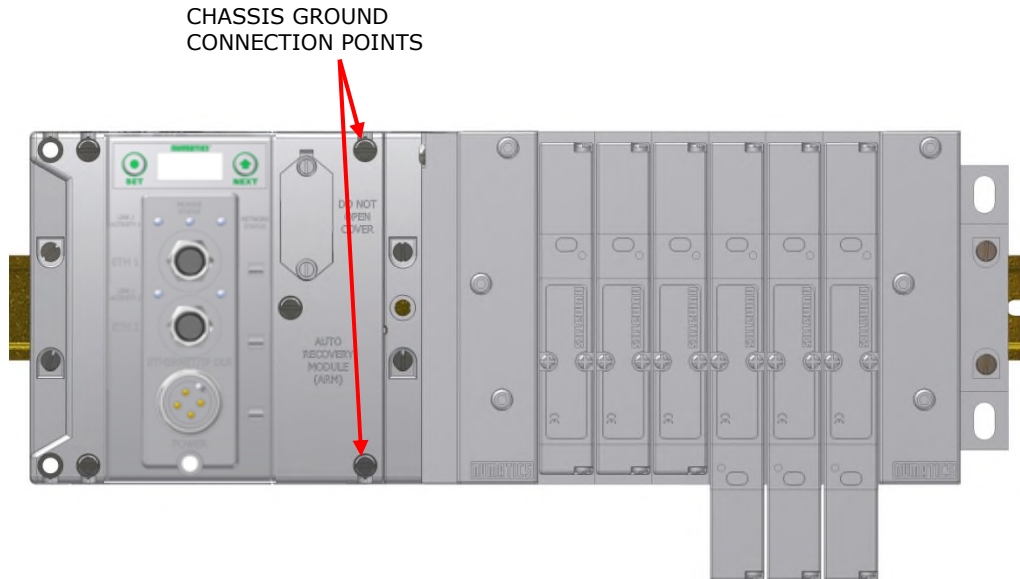

- *Proper grounding will prevent many intermittent problems with network communication.*
- *When grounding to a machine frame, please ensure that the machine frame itself is already properly grounded.*
- *Better grounding can be achieved when larger diameter (lower gauge) wire is used.*

NUMATICS G3 Series EtherNet/IP™ Technical Manual

4.6 Power Consumption

Power Connection

CENELEC Pin No.	Function	Description
1	+24 VDC (Valves and Outputs)	Voltage used to power outputs (valve coils and discrete outputs) SW
2	+24 VDC (Node and Inputs)	Voltage used to power discrete inputs and node electronics UNSW
3	0 VDC Common (Node and Inputs)	0 VDC (-V) Voltage used to power discrete inputs and node electronics UNSW
4	0 VDC Common (Valves and Outputs)	0 VDC (-V) Voltage used to power outputs (valve coils and discrete outputs) SW

Power Rating

- For maximum supply current capability please refer to page 59.
- Loads should not draw more than 0.5 Amps of current from any one individual discrete output point (Contact factory for higher current capability requirements).

Component	Voltage	Tolerance	+24VDC (Valves and Outputs) Pins 1 and 4		+24VDC (Node and Inputs) Pins 2 and 3	
			Current	Power	Current	Power
Solenoid Valve Coil 501 (Each)	24 VDC	+10%/-15%	0.03 A	0.80 W	0 A	0 W
Solenoid Valve Coil 502 (Each)	24 VDC	+10%/-15%	0.06 A	1.30 W	0 A	0 W
Solenoid Valve Coil 503 (Each)	24 VDC	+10%/-15%	0.07 A	1.70 W	0 A	0 W
Solenoid Valve Coil 2002 (Each)	24 VDC	+10%/-15%	0.02 A	0.48 W	0 A	0 W
Solenoid Valve Coil 2005 (Each)	24 VDC	+10%/-15%	0.06 A	1.44 W	0 A	0 W
Solenoid Valve Coil 2012 (Each)	24 VDC	+10%/-15%	0.11 A	2.64 W	0 A	0 W
Solenoid Valve Coil 2035 (Each)	24 VDC	+10%/-15%	0.11 A	2.64 W	0 A	0 W
Solenoid Valve Coil ISO 5599/2- SPA	24 VDC	+10%/-15%	0.17 A	4.08 W	0 A	0 W
Valve Adapter (Driver)	24 VDC	+/- 10%	0.03A	0.72 W	0.02 A	0.48 W
Digital Module	24 VDC	+/- 10%	0.04 A	0.96 W	0.05 A*	1.20 W*
Analog Module	24 VDC	+/- 10%	0.01 A	0.24 W	0.08 A*	1.92 W*
Sub-Bus Hub	24 VDC	+/- 10%	0 A	0 W	0.06 A	1.44 W*
RTD Module	24 VDC	+/- 10%	0.01 A	0.24 W	0.06 A	1.44 W*
Communication Module (Node)	24 VDC	+/- 10%	0.01 A	0.24 W	0.07A*	1.68 W*
Sub-Bus Valve Module	24 VDC	+/- 10%	0.01 A	0.24 W	0.03 A*	0.72 W*
Auto Recovery Module (ARM)	24 VDC	+/- 10%	0 A	0 W	0.03 A	0.72 W
Manual Configuration Module (MCM)	24 VDC	+/- 10%	0 A	0 W	0.03 A	0.72 W

* Current depends on graphic display brightness setting. Max. value shown with high brightness. Values decrease by approx. 5% for Medium and 11% for Low brightness settings.



- Total power consumption for each Discrete I/O point is dependent on the specific current draw of input sensor devices and output loads.

numatics G3 Series EtherNet/IP™ Technical Manual

Recommended External Fuses

External fuses should be chosen based upon the physical manifold configuration. Please refer to the following table for the fuse sizing chart.

External Fuse Sizing Chart

<i>Power Consumption - Power Connector Pin for Valves and Outputs</i>		
<u>Description</u>		<u>Current</u>
Number of Solenoid Valve Coils Energized Simultaneously		
___ X 0.17 A (ISO - SPA Series)	=	_____ Amps
___ X 0.11 A (2012 and 2035 Series)	=	_____ Amps
___ X 0.06 A (2005 Series)	=	_____ Amps
___ X 0.02 A (2002 Series)	=	_____ Amps
___ X 0.03 A (501 Series)	=	_____ Amps
___ X 0.06 A (502 Series)	=	_____ Amps
___ X 0.07 A (503 Series)	=	_____ Amps
		+
Total load current drawn by simultaneously energized Discrete Outputs	=	_____ Amps
		+
Number of I/O modules installed ___ X 0.01 A	=	_____ Amps
		+
Valve Adapter	=	0.03 Amps
		+
Communication Node Power Consumption	=	0.01 Amps
		+
Total:		_____ Amps
Surge Compensation:	X	1.25
Suggested External +24 VDC (Valves and Outputs) Fuse Value:		_____ Amps
<i>Power Consumption - Power Connector Pin for Node and Inputs</i>		
<u>Description</u>		<u>Current</u>
Communication Node Power Consumption	=	0.07 Amps
		+
Total load current drawn by Sensor Devices from Discrete Inputs source	=	_____ Amps
		+
Number of I/O modules installed ___ X 0.08 A	=	_____ Amps
		+
Total:		_____ Amps
Surge Compensation:	X	1.25
Suggested External Pin +24 VDC (Node and Inputs) Fuse Value:		_____ Amps

*Factory Default Settings



- The Node and Inputs Aux Power pins supply power to the node electronics. These pins must be powered at all times for communication node and Inputs to be functional.
- The internal electronic fuses exist to protect against damage due to catastrophic failure of internal components. External fuses are always recommended for protection against power supply failure, over-current conditions, etc.

NUMATICS G3 Series EtherNet/IP™ Technical Manual

4.7 Diagnostics

Communication Module LED Functions

Upon power up, the LEDs indicate the status of the unit. There are three LEDs on the G3 EtherNet node. These LEDs are described below.



LED Name	Color	Status	Description
MODULE STATUS	Off	OFF	No power applied to +24V <small>NODE/IN.</small>
	Green	ON	Device operational. The module is operating correctly.
	Green	FLASHING	Standby. The module has not been configured.
	Red	ON	Major fault. A major internal error has been detected.
	Red	FLASHING	Minor fault. A minor recoverable fault has been detected.
NETWORK STATUS	Green	ON	Connected. The module has established an EtherNet/IP™ connection.
	Green	FLASHING	No connection. There are no EtherNet/IP™ connections established to the module.
	Red	ON	Duplicate IP address. The module has detected that its IP address is already being used elsewhere on the network
	Red	FLASHING	EtherNet/IP™ connection has timed out. One or more of the connections for which this module is the target has timed out.
ACTIVITY/LINK	Green	OFF	No EtherNet connection is detected
	Green	ON	The module is connected to an EtherNet™ network
	Green	FLASHING	The LED flashes each time a packet is received or transmitted.

NUMATICS G3 Series EtherNet/IP™ Technical Manual

Output Short Circuit Protection

G3 Output modules incorporate short circuit protection and diagnostics to identify short circuit, open coils and over temperature conditions. The diagnostics can be accessed within the user PLC program or the G3 EtherNet/IP™ node's integrated web page. Detailed information regarding these features can be found on page 147.

<i>Output Type</i>	<i>Output State</i>	<i>Fault Condition</i>	<i>Status Bit</i>
Valve Solenoid Coil Driver	ON	No Fault	0
		Fault - Short Circuit, Over Temp/Over Current	1
Valve Solenoid Coil Driver	OFF	No Fault	0
		Fault - Open Load	1
Discrete Outputs	ON	No Fault	0
		Fault - Short Circuit, Over Temp/Over Current	1

5. G3 Graphic Display

The G3 Communication and I/O modules feature an integrated graphic display used to configure parameters and display diagnostic information.



The graphic displays on the following page represent the main menu selections of the EtherNet/IP™ communication module (node).

numatics G3 Series EtherNet/IP™ Technical Manual

5.1 Main Menu Structure

Use the NEXT button to scroll through the Main menu headings shown below. At this level pressing the SET button allows access the Sub-Menus. Please see the appropriate pages referenced below for further details and descriptions of the Sub-Menus. Note that many of these settings can also be adjusted via software with GSD file parameters.

NOTE: When a network I/O connection is established manual changes to node parameters are not allowed!

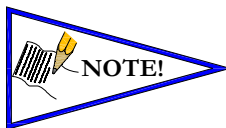
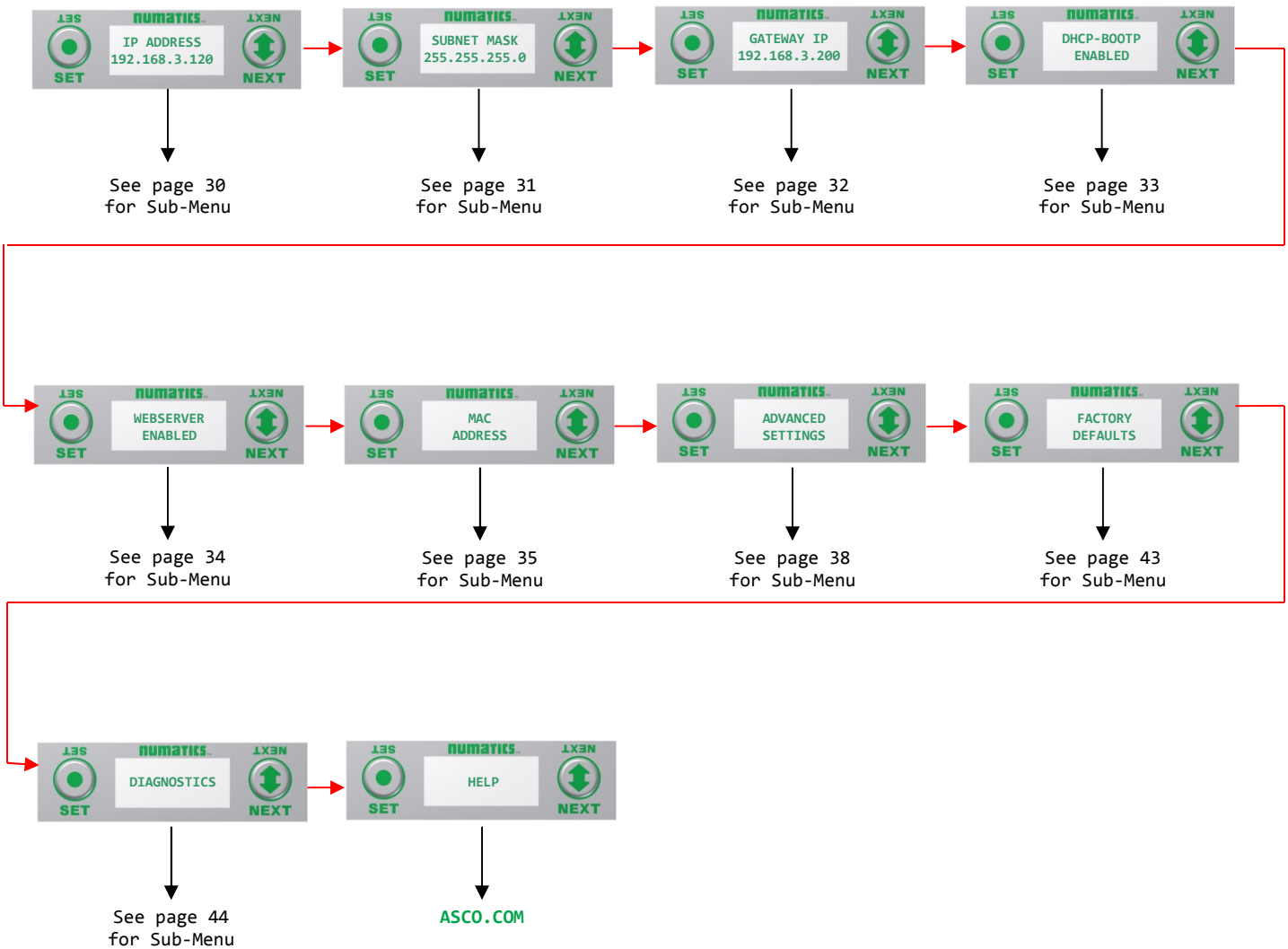

• When a network I/O connection is established manual changes to node parameters are not allowed!

numatics G3 Series EtherNet/IP™ Technical Manual

5.2 IP Address

Steps to Set IP Address

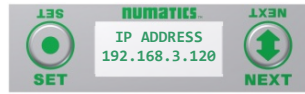

1. Press the SET button to enter the IP ADDRESS sub-menu.



2. Press the NEXT button to select the octet that you would like to change.
Press the SET button to change the value.



3. Press the SET button to scroll through the hundred, tens and ones digits of the octet.
Press the NEXT button to scroll through the valid digits (0-9).
Press the SET button to advance through the octet.



4. Press the NEXT button to advance to the next octet, scroll pass the fourth octet to accept the entire IP Address



5. Press the NEXT button to select Yes or No to accept the IP Address shown on the display.

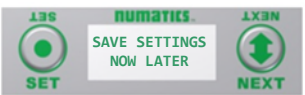

- a. Selecting No will bring you back to the main Address menu.
 - b. Selecting Yes will take you to the following SAVE SETTINGS menu
6. Press the NEXT button to select either NOW or LATER.
 - a. Selecting NOW will cause the node to reset and apply the new setting.
 - b. Selecting LATER will cause the new Address to be saved in temporary memory to allow you to make additional parameter changes before the node is reset. However, you must ACCEPT the saved changes before your next power cycle otherwise they will be lost.

Press the SET button to confirm your choice.



- Factory default address is 192.168.3.120
- 0 and 255 are not valid for the fourth octet

5.3 Subnet Mask

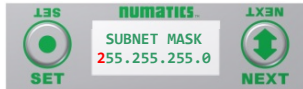
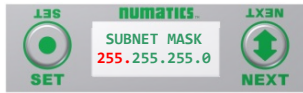
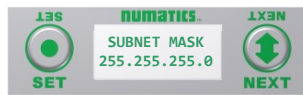

Steps to Set Subnet Mask

1. Press the SET button to enter the Subnet Mask sub-menu.
2. Press the NEXT button to select the octet that you would like to change. Press the SET button to change the value.
3. Press the SET button to scroll through the hundred, tens and ones digits of the octet. Press the NEXT button to scroll through the valid digits (0-9). Press the SET button to advance through the octet. Press the NEXT button to advance to the next octet, scroll pass the fourth octet to accept the entire Subnet Mask
4. Press the SET button to input the value shown on the display,
5. Press the NEXT button to select Yes or No to accept the Subnet Mask shown on the display.
 - c. Selecting No will bring you back to the main Subnet Mask menu.
 - d. Selecting Yes will take you to the following SAVE SETTINGS menu
6. Press the NEXT button to select either NOW or LATER.
 - c. Selecting NOW will cause the node to reset and apply the new setting.
 - d. Selecting LATER will cause the new Address to be saved in temporary memory to allow you to make additional parameter changes before the node is reset. However, you must ACCEPT the saved changes before your next power cycle otherwise they will be lost.

Press the SET button to confirm your choice.



- Factory default subnet mask is 255.255.255.0

5.4 Gateway IP

Steps to Set Gateway IP

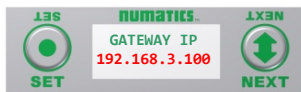

1. Press the SET button to enter the Gateway IP sub-menu.
2. Press the NEXT button to select the octet that you would like to change. Press the SET button to change the value.
3. Press the SET button to scroll through the hundred, tens and ones digits of the octet. Press the NEXT button to scroll through the valid digits (0-9). Press the SET button to advance through the octet. Press the NEXT button to advance to the next octet, scroll pass the fourth octet to accept the entire Subnet Mask
4. Press the SET button to input the value shown on the display,
5. Press the NEXT button to select Yes or No to accept the Subnet Mask shown on the display.
 - e. Selecting No will bring you back to the main Subnet Mask menu.
 - f. Selecting Yes will take you to the following SAVE SETTINGS menu
6. Press the NEXT button to select either NOW or LATER.
 - e. Selecting NOW will cause the node to reset and apply the new setting.
 - f. Selecting LATER will cause the new Address to be saved in temporary memory to allow you to make additional parameter changes before the node is reset. However, you must ACCEPT the saved changes before your next power cycle otherwise they will be lost.



- *Factory default Gateway IP is 0.0.0.0*

numatics G3 Series EtherNet/IP™ Technical Manual

5.5 DHCP-BOOTP

This will allow the enabling / disabling of the DHCP (Dynamic Host Control Protocol) and / BOOTP parameters. Enabling this parameter will allow the IP Address to be set via a BOOTP/DHCP server.

DHCP-BOOTP Steps

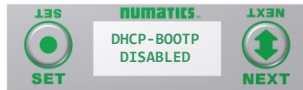

1. Press the SET button to enter the DHCP-BOOTP sub-menu.

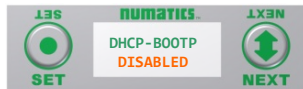

2. Press the NEXT button to scroll through the choices to enable or disable the feature.

- a. ENABLED (Factory Default)
- b. DISABLED
- c. RETURN (this will return you to the main menu)

Press the SET button to confirm your choice.

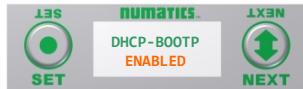

3. Press the NEXT button to select Yes or No to accept the selection.

- a. Selecting No will bring you back to the main menu.
- b. Selecting Yes will take you to the following apply changes menu.

Press the SET button to confirm your choice.

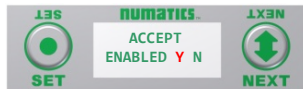

Apply Changes Steps

4. Press the NEXT button to select either NOW or LATER.
 - a. Selecting NOW will cause the node to reset and apply the new setting.
 - b. Selecting LATER will cause the new setting to be saved in memory, you must accept the saved changes before your next power cycle otherwise they will be lost.

Press the SET button to confirm your choice.



- *Factory default setting for DHCP-BOOTP is enabled.*

NUMATICS[®] G3 Series EtherNet/IP™ Technical Manual

5.6 Web-Server

This will allow the enabling/disabling of the G3 Web Server.

Web-Server Steps



5. Press the SET button to enter the Web-Server sub-menu.

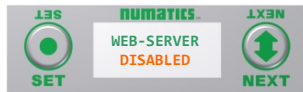

6. Press the NEXT button to scroll through the choices to enable or disable the feature.

- d. ENABLED (Factory Default)
- e. DISABLED
- f. RETURN (this will return you to the main menu)

Press the SET button to confirm your choice.

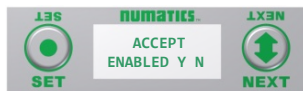

7. Press the NEXT button to select Yes or No to accept the selection.

- c. Selecting No will bring you back to the main menu.
- d. Selecting Yes will take you to the following apply changes menu.

Press the SET button to confirm your choice.

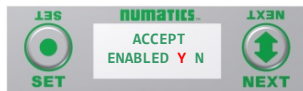

Apply Changes Steps



8. Press the NEXT button to select either NOW or LATER.
- c. Selecting NOW will cause the node to reset and apply the new setting.
 - d. Selecting LATER will cause the new setting to be saved in memory, you must accept the saved changes before your next power cycle otherwise they will be lost.

Press the SET button to confirm your choice.



- Factory default setting for WEB-SERVER is enabled.

numatics G3 Series EtherNet/IP™ Technical Manual

5.7 MAC Address



MAC (Machine Access Control) Address

1. The MAC Address is a fixed unique value that cannot be edited.

The actual MAC ADDR has an extra leading zero. The actual number in the example shown is 00-15-24-00-06-69



NOTE!

- *The MAC address is for reference and cannot be modified.*

NUMATICS® G3 Series EtherNet/IP™ Technical Manual

5.8 Advanced Settings - I/O Diag. Menu

This menu allows the enabling/disabling of all the I/O status bits. The I/O status bits include valve coil, discrete outputs, input short circuit, and alarm status bits. The default condition is Enabled

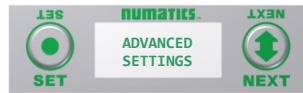

I/O Status Steps

1. Press the SET button to enter the ADVANCED SETTINGS sub-menu.

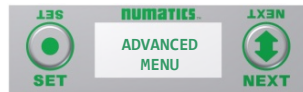

2. Press the SET button to enter the CONFIG MENU / DIAG. STATUS.



3. Press the SET button to enter the DIAG. STATUS I/O DIAG.

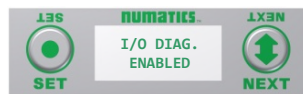

4. Press the NEXT button to scroll through the choices to enable/disable the Diagnostic status for I/O.

- a. ENABLED (Factory Default)
- b. DISABLED
- c. RETURN (this will return you to the DIAG. STATUS menu)

Press the SET button to confirm your choice.



5. Press NEXT to confirm the warning message.

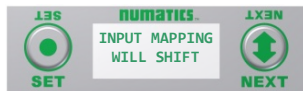

6. Press the NEXT button to select Yes or No to accept the selection

- a. Selecting No will bring you back to the main SET STATUS menu.
- b. Selecting Yes will take you to the following saved settings menu.

Press the SET button to confirm your choice.

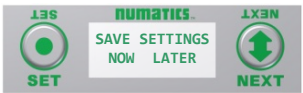

Save Settings Steps

7. Press the NEXT button to select either NOW or LATER.
 - a. Selecting NOW will cause the node to reset and apply the new setting.
 - b. Selecting LATER will cause the new I/O STATUS selection to be saved in memory, you must Accept the saved changes before your next power cycle otherwise they will be lost.

Press the SET button to confirm your choice.



I/O Status Bits are diagnostic bits. They include the valve coil status bits, AUX Power status bits, and Short Circuit & Alarm status bits of various I/O modules.

numatics G3 Series EtherNet/IP™ Technical Manual

5.9 Advanced Settings – Node Diagnostics (Diagnostic Word)

This menu allows the enabling/disabling of the diagnostic word status bits. The Diagnostic word bits include power status and sub-bus related status bits. Detail information regarding these bits can found on page 12-147. The diagnostic word comes enabled from the factory.

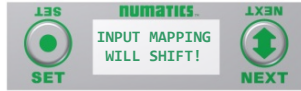
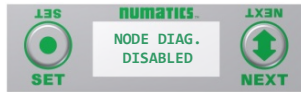
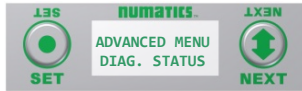
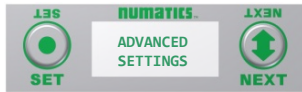

Diag. Word Status Settings

1. Press the SET button to enter the ADVANCED SETTINGS menu.
2. Press the SET button to enter the ADVANCED MENU / DIAG. STATUS.
3. Press the NEXT button to scroll to the DIAG. STATUS / NODE DIAG. menu.
Press the SET button to enter the DIAG. STATUS / NODE DIAG. menu.
4. Press the NEXT button to scroll the choices to enable/disable the I/O status.
 - a. ENABLED (Factory Default)
 - b. DISABLED
 - c. RETURN (this will return you to the DIAG. STATUS menu)

Press the SET button to confirm your choice.

5. Press Next to confirm the warning message.

6. Press the NEXT button to select Yes or No to accept the selection
 - a. Selecting No will bring you back to the main SET STATUS menu.
 - b. Selecting Yes will take you to the following saved settings menu.

Press the SET button to confirm your choice.

Save Settings Steps

7. Press the NEXT button to select either NOW or LATER.
 - a. Selecting NOW will cause the node to reset and apply the new setting.
 - b. Selecting LATER will cause the new NODE DIAG selection to be saved in memory, you must Accept the saved changes before your next power cycle otherwise they will be lost.

Press the SET button to confirm your choice.

numatics G3 Series EtherNet/IP™ Technical Manual

5.10 Advanced Settings – Comm. Fault

This will allow the enabling / disabling of the Fault Action parameter. The Fault Action parameter determines the behavior of the outputs during a communication fault. Please see page 133 for more details.

Fault Action Settings

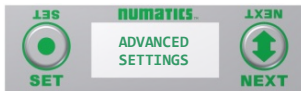

1. Press the SET button to enter the ADVANCED SETTINGS menu.

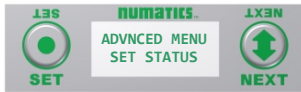

2. Press the NEXT button to scroll to the ADVANCED MENU / SET FAULT IDLE.
3. Press the SET button to enter the ADVANCED MENU / SET FAULT IDLE.



4. Press the SET button to enter the SET FAULT IDLE / FAULT ACTION menu.



5. The current state of the parameter is shown



6. Press the SET button to change this parameter
Press the NEXT button to scroll the choices for the desired output action during a fault state.

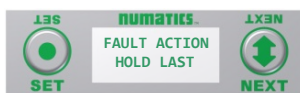

- a. OFF (Factory Default)
- b. HOLD LAST STATE
- c. RETURN (this will return you to the SET FAULT/IDLE menu)

Press the SET button to confirm your choice.

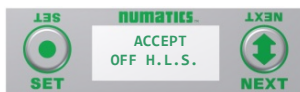
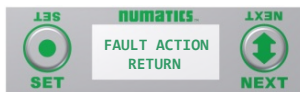

7. Press the NEXT button to select Yes or No to accept the selection
Press the SET button to confirm your choice

- a. Selecting No will bring you back to the main SET FAULT/IDLE menu.
- b. Selecting Yes will take you to the following saved settings menu.

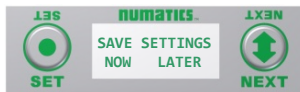

Save Settings Steps

8. Press the NEXT button to select either NOW or LATER.
Press the SET button to confirm your choice.

- a. Selecting NOW will cause the node to reset and apply the new setting
- b. Selecting LATER will cause the new FAULT ACTION selection to be saved in memory, you must Accept the saved changes before your next power cycle otherwise they will be lost.

Press the SET button to confirm your choice.



- Factory Default is FAULT ACTION OFF, See page 133 for more details.

numatics G3 Series EtherNet/IP™ Technical Manual

5.11 Advanced Settings - Brightness

Brightness Settings



1. Press the SET button to enter the ADVANCED SETTINGS menu.



2. Press the NEXT button to scroll to the CONFIG MENU / SET BRIGHTNESS. Press the SET button to enter the CONFIG MENU / SET BRIGHTNESS.

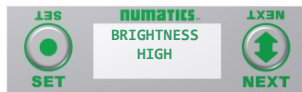

3. The current state of the parameter is shown



4. Press the SET button to change this parameter. Press the NEXT button to scroll the choices for the desired brightness of the graphic display for all modules on the G3 system.



- a. LOW
- b. MEDIUM
- c. HIGH (Factory Default)



Press the SET button to confirm your choice. The changes will take effect immediately.

numatics G3 Series EtherNet/IP™ Technical Manual

5.12 Advanced Settings – Flip Display

Flip Display Settings

1. Press the SET button to enter the ADVANCED SETTINGS menu.
2. Press the NEXT button to scroll to the CONFIG MENU / FLIP DISPLAY.
Press the SET button to enter the CONFIG MENU / FLIP DISPLAY.
3. The current state of the parameter is shown
4. Press the NEXT button to change this parameter
 - a. YES
 - b. RETURNPress the SET button to confirm your choice.

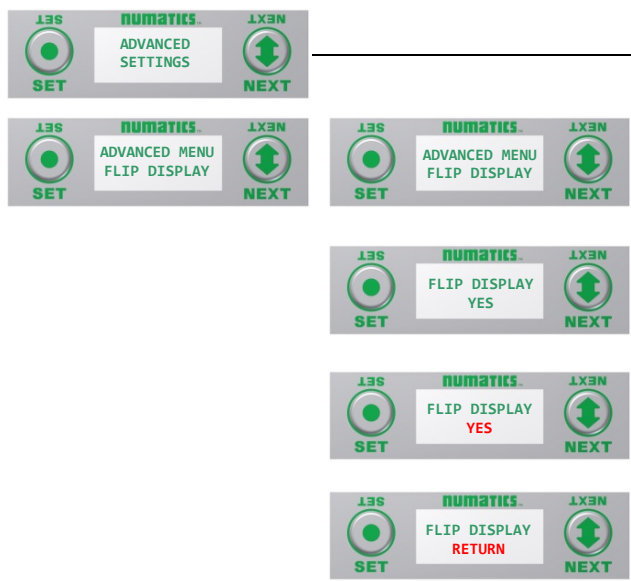

- This a global setting that affects all modules
- Each module, however, has its own setting if different settings are required.

5.13 Advanced Settings – Parameters Lock

PARAMETER Steps



1. Press the SET button to enter the Parameters sub-menu.



2. Press the NEXT button to scroll through the choices to enable or disable the feature.



- g. UNLOCKED (Factory Default)
- h. LOCKED
- i. RETURN (this will return you to the main menu)

Press the SET button to confirm your choice.

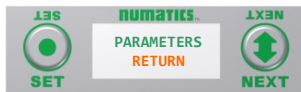

By choosing LOCKED, all settable parameters will be read only via the graphic display. UNLOCKED, the factory default, will allow all parameters to be settable through the graphic display.

Please note that all parameters are read only, regardless of this setting, when an IO connection between the communication module and the controller (PLC) is present



3. Press the NEXT button to select Yes or No to accept the selection.



- e. Selecting No will bring you back to the main menu.
- f. Selecting Yes will take you to the following apply changes menu.



Press the SET button to confirm your choice.

Apply Changes Steps

4. Press the NEXT button to select either NOW or LATER.
 - e. Selecting NOW will cause the node to reset and apply the new setting.
 - f. Selecting LATER will cause the new setting to be saved in memory, you must accept the saved changes before your next power cycle otherwise they will be lost.

Press the SET button to confirm your choice.

numatics G3 Series EtherNet/IP™ Technical Manual

5.14 Advanced Settings – Configuration Lock

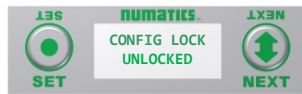
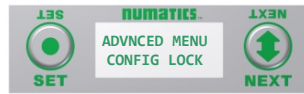

Configuration Lock Settings

1. Press the SET button to enter the ADVANCED SETTINGS menu.
 2. Press the NEXT button to scroll to the CONFIG MENU / CONFIG. LOCK.
Press the SET button to enter the CONFIG MENU / CONFIG. LOCK.
 3. The current state of the parameter is shown
 4. Press the SET button to change this parameter
 5. Press the NEXT button to scroll through the choices to enable or disable the feature.
 - a. UNLOCKED (Factory Default)
 - b. LOCKED
 - c. RETURN (this will return you to the main menu)
- Press the SET button to confirm your choice.

6. Press the NEXT button to select Yes or No to accept the selection.
 - g. Selecting No will bring you back to the main menu.
 - h. Selecting Yes will take you to the following apply changes menu.

Press the SET button to confirm your choice.

Apply Changes Steps

7. Press the NEXT button to select either NOW or LATER.
 - g. Selecting NOW will cause the node to reset and apply the new setting.
 - h. Selecting LATER will cause the new setting to be saved in memory, you must accept the saved changes before your next power cycle otherwise they will be lost.

Press the SET button to confirm your choice.

Note;

By choosing LOCKED, the manifold configurations will be stored in memory and the PHYSICAL manifold configuration cannot be changed. UNLOCKED, the manifold configurations can be changed without errors.

NUMATICS G3 Series EtherNet/IP™ Technical Manual

5.15 Factory Defaults

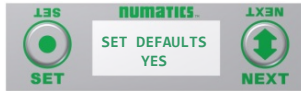

Factory Default Settings

1. Press the SET button to enter the FACTORY DEFAULTS sub-menu.
2. Press the SET button to change this parameter
3. Press the NEXT button to select Yes or No.
 - a. Selecting No will bring you back to the main FACTORY DEFAULTS menu.
 - b. Selecting Yes will cause the node to reset and return all parameters to the factory default conditions.
 - c. Selecting RETUTN will bring you back to the main FACTORY DEFAULTS menu

Press the SET button to confirm your choice.

FACTORY DEFAULT SETTINGS	
Description	Default
IP Address	192.168.3.120
Sub Net Mask	255.255.255.0
DHCP Boot-P	Enabled
Web Server	Enabled
Diagnostic Word	Enabled
I/O Diagnostic Status	Enabled
Fault Action	Reset to All Off
Idle Action	Reset to All Off
Brightness	High
Parameters	Unlocked

numatics G3 Series EtherNet/IP™ Technical Manual

5.16 Diagnostics

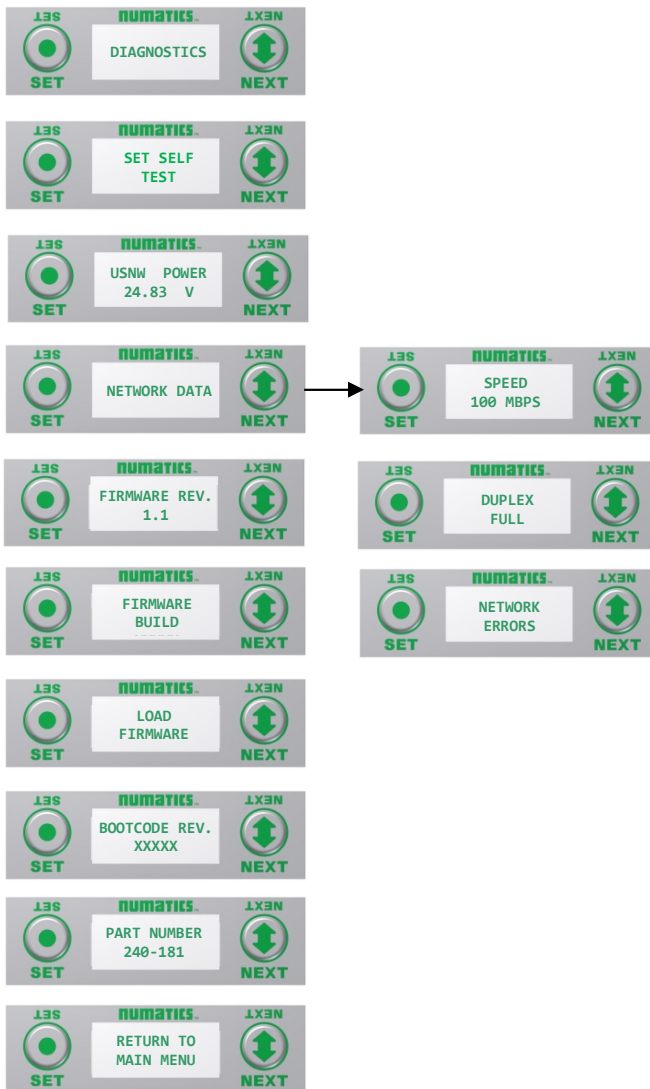

1. All diagnostic information is read only
2. Press the SET button to enter DIAGNOSTICS sub-menu.
3. Press the NEXT button to scroll through the main diagnostic menu choices.
 - a. SET SELF TEST
 - i. - Please see following page for description
 - b. UNSW POWER
 - i. - Displays voltage level of unswitched power (Node & Inputs)
 - c. NETWORK DATA
 - i. - Displays the network diagnostics
 - d. FIRMWARE REVISION
 - i. - For service personnel
 - e. FIRMWARE BUILD
 - i. - For service personnel
 - f. LOAD FIRMWARE
 - i. - For service personnel
 - g. BOOTCODE REVISION
 - i. - For service personnel
 - h. BOOTCODE BUILD
 - i. - For service personnel
 - i. PART NUMBER
 - i. - Displays replacement part number of module
 - j. RETURN TO MAIN MENU



- The UNSW POWER screen indicates the voltage level present on the UNSW (Node & Input) power pins (Pin No. 2 and 3) of the main power connector.

numatics G3 Series EtherNet/IP™ Technical Manual

5.17 Diagnostics - Self Test Mode

An internal diagnostic tool can be enabled on the communication module (node) using the graphic display. This tool allows the user to confirm that all of the inputs and outputs on the manifold and any of the distributed modules are fully functional without needing a network connection or controller. There are two test modes that the user can choose. The "CYCLE OUTPUTS" test mode tests all the outputs by sequentially turning them ON and OFF for approximately .5 seconds. The "INPUTS" test mode tests the inputs by causing all of the outputs to toggle between even and odd values when any input is made. The Self Test mode on the communication module (node) is a global setting and will test all devices connected on the main manifold as well as any distributed modules and/or manifolds.

Similar "local" self tests are available on all output modules types. This "local" self test function allows any output module to be tested without affecting any other output module.

NOTE: The number of Valve outputs that are tested are affected by the I/O size settings.

To use the Self Test Mode, the user must first set some initial conditions. Follow these steps to initiate the self-test mode.

- 1) **Disconnect Air and Communication from the manifold!**
- 2) Select the desired test mode using the graphic display. (See example below)
- 3) Starting at the Home Screen, navigate the menus by selecting the NEXT button until the DIAGNOSTICS menu is shown.
- 4) Select the SET button to access the DIAGNOSTICS menu and then again to access the SELF-TEST menu
- 5) Push NEXT to navigate to the desired test mode: CYCLE OUTPUTS or INPUTS
- 6) Push SET to select the desired test mode.
- 7) A message will appear: DISCONNECT AIR HOLD SET BUTTON
- 8) Hold the SET button down for approximately 10 seconds to enable the test. The Display will flash the above message while the button is pushed.
- 9) When the display stops flashing, the self-test mode will run and the Module Status LED will flash Red/Green while the display shows SELF TEST RUNNING.
- 10) The global self-test mode can only be disabled by disconnecting the power to the manifold.

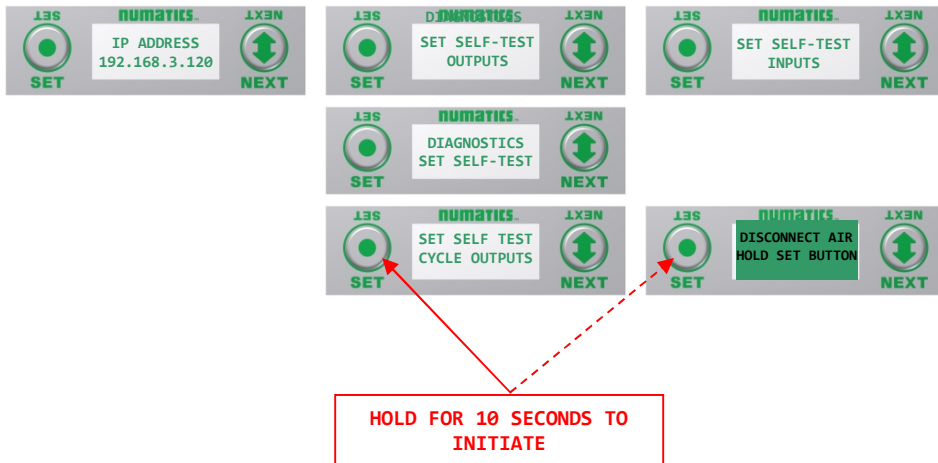

numatics G3 Series EtherNet/IP™ Technical Manual

5.18 Error Messages

The following are automatic error messages that are displayed when specific faults occur during operation:

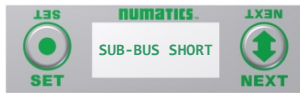

Displayed when a short circuit condition is detected on the Sub-Bus power lines

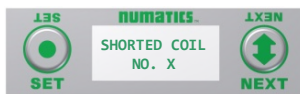

Displayed when a short circuit condition is detected on a valve coil

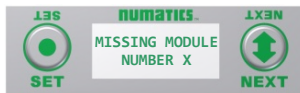

Displayed when a Sub-Bus module that had been previously installed becomes absent from the configuration

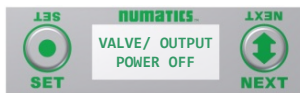

Displayed when +24 VDC on Pin No. 1 and No. 4 (Valves and Outputs) is not present or below 22 VDC



Displayed when +24 VDC on Pin No. 2 and No. 3 (Node and Inputs) is below 19 VDC

6. ARM – Auto Recovery Module (Optional)

The Auto Recovery Module (ARM) is an optional memory module that is installed between the node and the valve adapter module and is used to preserve the manifold system parameters even during catastrophic failure. During the power-up process it reads the configuration of the manifold, including any user settable parameters of I/O modules, and stores the information in its non-volatile memory. Once the information is stored, it automatically disconnects itself from the power circuits while still mechanically attached to the manifold.



Description	Replacement Part Number
Complete ARM Module	240-182

6.1 ARM process flowchart

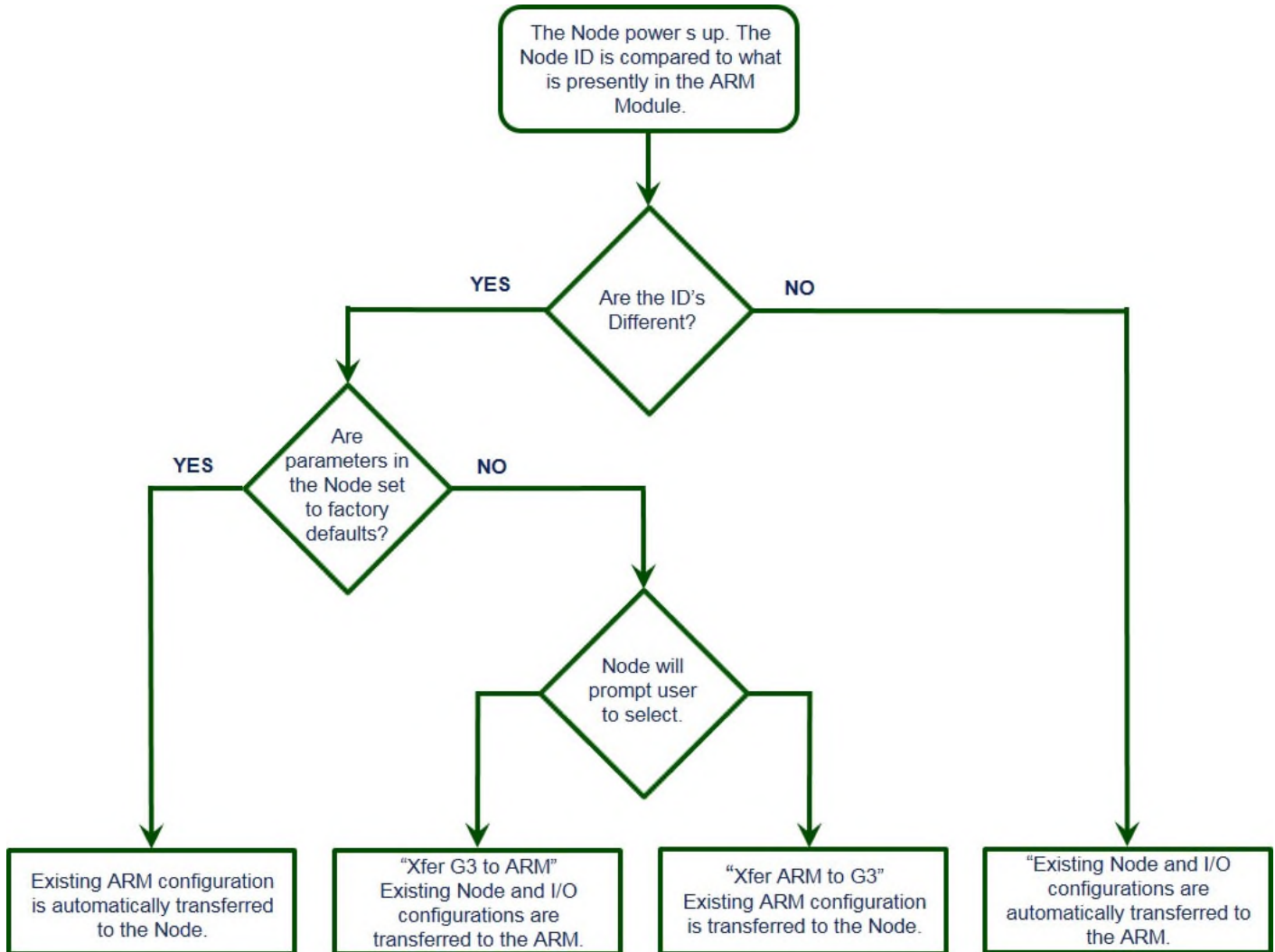

7. Distribution

Distribution of I/O capability can be easily achieved with the G3 platform by means of Sub-Bus modules. I/O modules, valve manifolds and/or a combination of both can be simply separated from the main manifold and distributed via a sub-bus communication cable. The G3 platform uses the same I/O modules on the main manifold as on the distribution chain. The main communication module can control up to 16 I/O modules either on the main manifold or as part of the sub-bus connections. To utilize the sub-bus distribution capabilities the Sub-Bus OUT module must be located on the end of the main communication manifold and a Terminator Module must be located at the last sub-bus component.

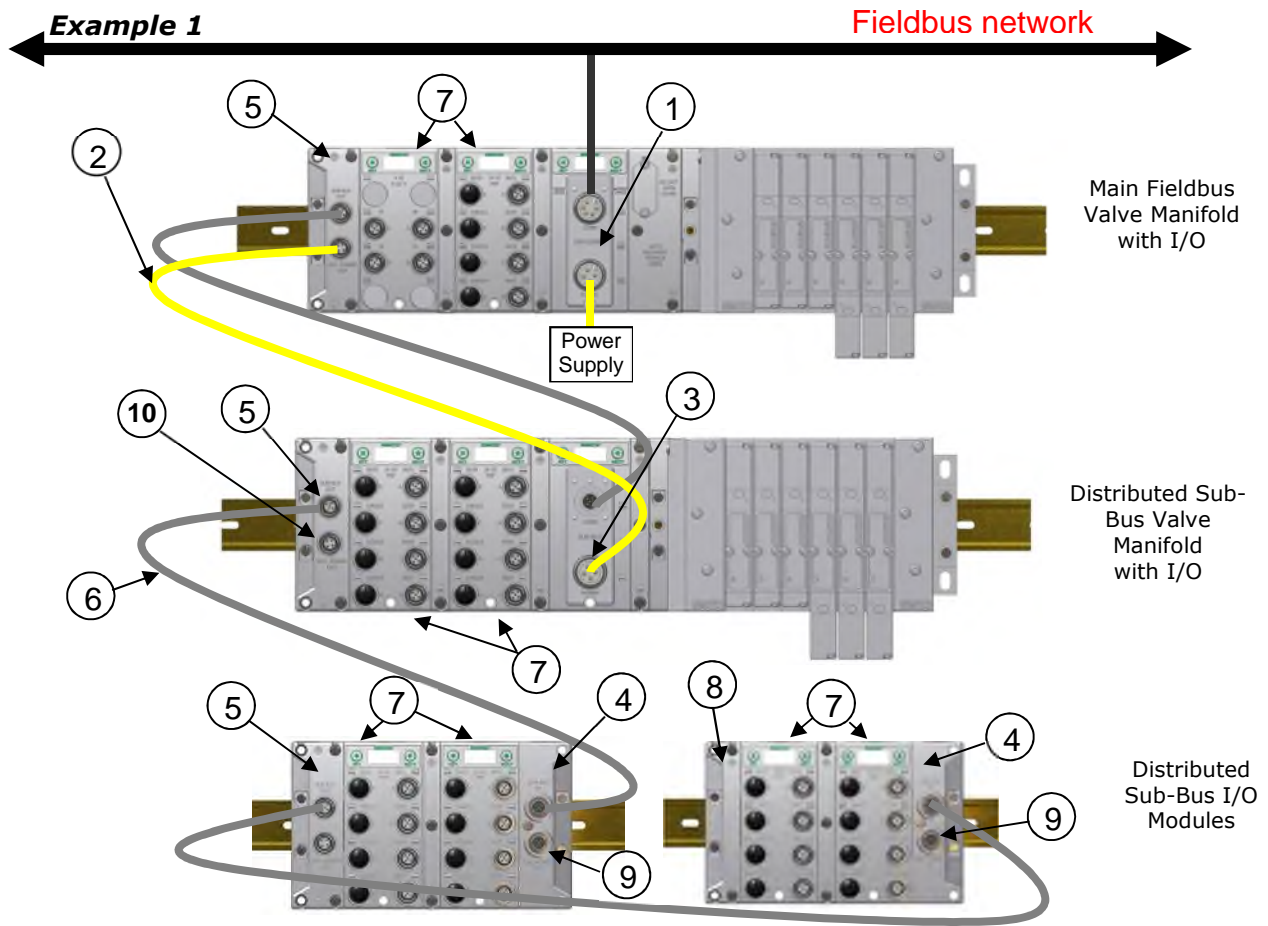

Detail No.	Description
1	Main Communication Module (Node)
2	Sub-Bus Power Cable (Can be connected to separate power supply for isolated power control)
3	Distributed Sub-Bus Valve Module
4	Sub-Bus IN module
5	Sub-Bus OUT module
6	Sub-Bus Communication Cable
7	I/O Modules
8	Terminator Module (Used to terminate sub-bus)
9	Aux. Power IN (Used to augment Input power and/or supply power to Output modules)
10	Aux. Power OUT (Can be used to supply power to distributed modules)

numatics G3 Series EtherNet/IP™ Technical Manual

7.1 Sub-Bus Distribution Modules

SUB-BUS OUT Module

- Used only when distributing the Sub-Bus to another assembly is required.
- SUB-BUS OUT - 5 pin M12 female communication connector.
 - Used to distribute the Sub-Bus to the next Sub-Bus assembly.
 - Carries 24 VDC power for electronics of the next module.
- AUX. POWER OUT - 4 pin M12 female aux. power connector.
 - Optional connection.
 - Used as a convenience way to distribute the power connection to the next Sub-Bus assembly.

Description	Replacement Part Number
Sub-Bus OUT module with Din Rail Mounting	240-244
Sub-Bus OUT module without Din Rail Mounting	240-183

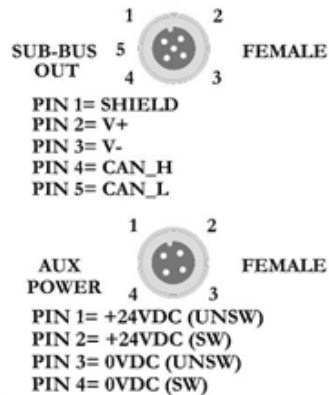
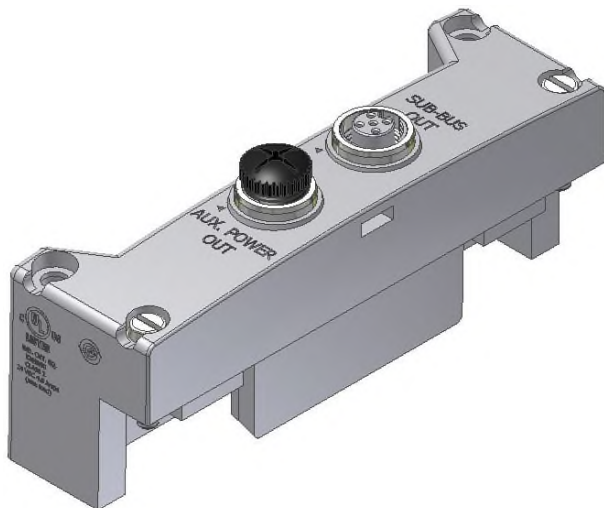

numatics G3 Series EtherNet/IP™ Technical Manual

SUB-BUS IN Modules

- Used to distribute I/O assemblies that do not have valves
 - Must be installed to the right of the I/O modules.
- SUB-BUS IN - 5 pin M12 male communication connector.
 - Must be connected to the Sub-Bus Out connector of the previous assembly
 - Carries 24 VDC power for electronics of module
- AUX. POWER IN - 4 pin M12 male connector.
 - Aux power is required for Output modules. This connection also allows Output power to be interrupted to all Output modules connected to this module.
 - Aux. Power is optional for Inputs. Power from the SUN-BUS IN connection is used to power sensors but can be augmented, if necessary, by adding additional power to this connector.

Description	Part Number
Sub-Bus IN module with Din Rail Mounting	240-246
Sub-Bus IN module without Din Rail Mounting	240-185

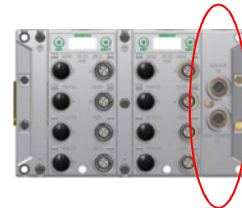
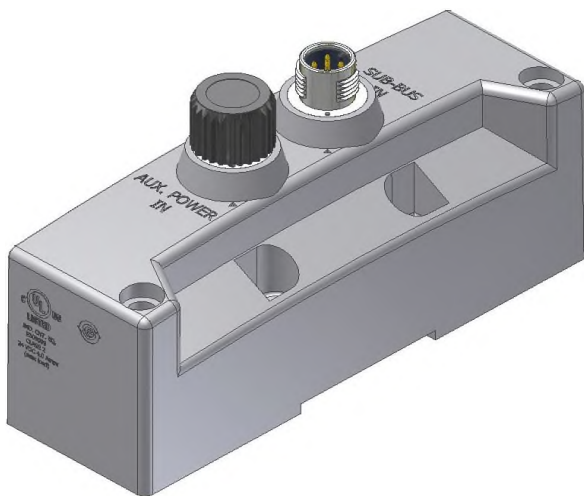

numatics G3 Series EtherNet/IP™ Technical Manual

Terminator Module

- Used to terminate SUB-BUS connections.
 - Must be installed on the left side of the last Sub-Bus module.

<i>Description</i>	<i>Part Number</i>
Terminator Module with Din Rail Mounting	240-245
Terminator Module without Din Rail Mounting	240-184

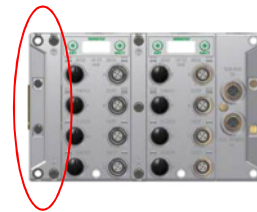
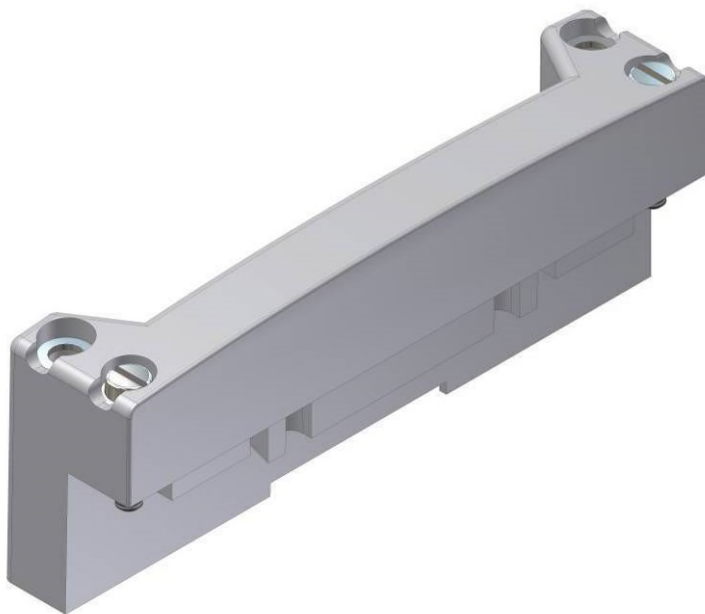

- *The terminator must be installed in the G3 system for proper operation.*

numatics G3 Series EtherNet/IP™ Technical Manual

Sub-Bus Valve Module

- COMM - 5 pin M12 male Sub-Bus input communication connector.
 - Must be connected to the SUB-BUS OUT connector of the previous assembly
 - Carries 24 VDC power for electronics of module
- POWER - 4 pin MINI male power connector.
 - Power is required for Outputs
- Used to distribute Valves on the Sub-Bus.
 - Can accept discrete I/O module to allow a Sub-Bus Valve manifold with I/O

Description	Part Number
Sub-Bus Valve Module	240-241



- The Sub-bus Valve Module drops 0.8 VDC across the module

numatics G3 Series EtherNet/IP™ Technical Manual

Sub-Bus Valve Module (without distribution and I/O)

- COMM - 5 pin M12 male Sub-Bus communication connector.
 - Must be connected to the SUB-BUS OUT connector of the previous assembly
 - Carries 24 VDC power for electronics of module
- POWER - 4 pin M12 male power connector.
 - Power is required for Outputs
- Used to distribute Valves on the Sub-Bus.
 - Does not allow connection to G3 I/O modules.

Description	Part Number
Sub-Bus Valve Module without I/O	P580AEDS4010A00

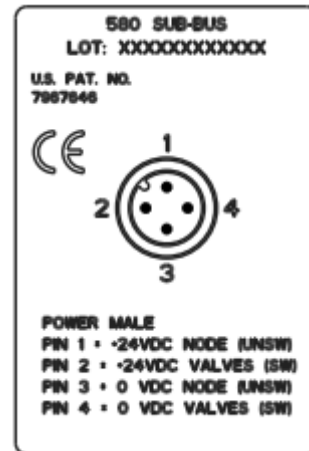
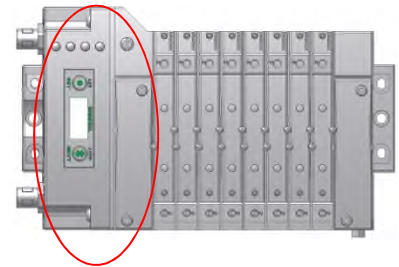
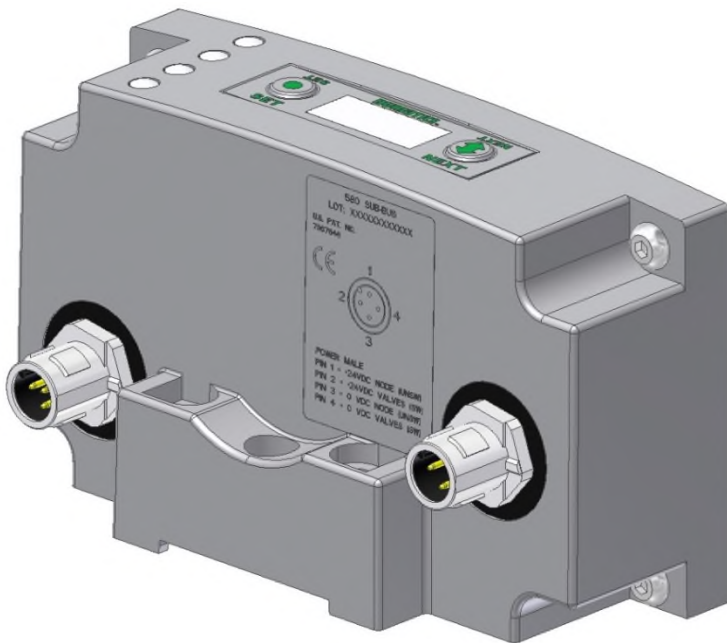

• The Sub-bus Valve Module drops 0.8 VDC across the module

NUMATICS G3 Series EtherNet/IP™ Technical Manual

Sub-Bus Hub Module

The G3 HUB module allows for branch distribution from the I/O side of the G3 System and can be integrated into the existing G3 Series Sub-Bus configuration. Auto Addressing allows for trouble free set up and configuration. Input, Output, as well as Valve manifolds can be attached to the available four Branches on a HUB module. Each G3 System can support up to two HUB modules, allowing for maximum flexibility. The HUB module is transparent to the I/O side of the G3 and does not reserve one of the potential sixteen positions.

- Used when distributing the Sub-Bus to another assembly.
- SUB-BUS OUT - 5 pin M12 female communication connector.
 - Used to distribute the Sub-Bus to the next Sub-Bus assembly.
 - Carries 24 VDC power (up to 3A) for electronics of the next module.
- Cannot connect a Hub to a branch of another Hub
- Each branch of the Hub can accommodate a sub-bus cable length of 30 meters.

Description	Part Number
Sub-Bus Hub Module	240-326

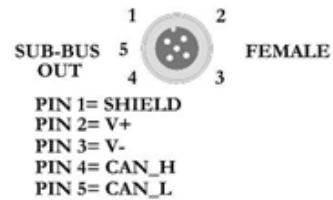
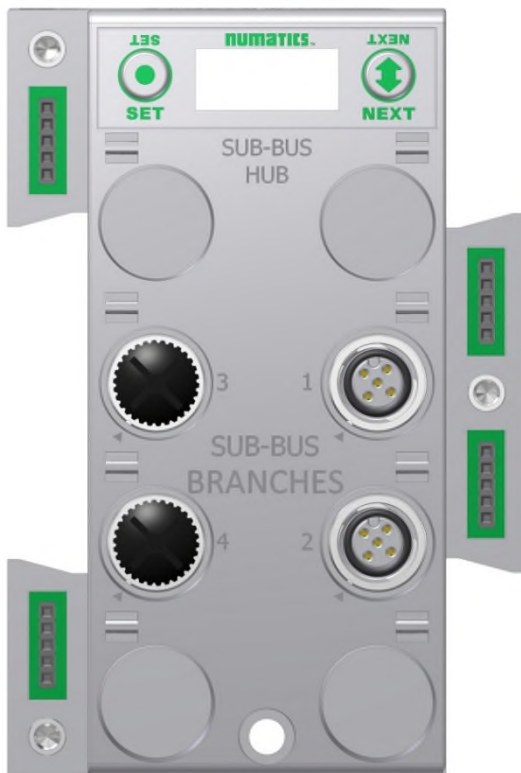

numatics G3 Series EtherNet/IP™ Technical Manual

7.2 Sub-Bus Cables



M12 STRAIGHT 5 PIN MALE TO FEMALE SUB-BUS CABLE - SHIELDED

TA0501MGDTC0571P – 1 Meter

TA0505MGDTC0571P – 5 Meter

TA0510MGDTC0571P – 10 Meter



M12 STRAIGHT 5 PIN FEMALE FIELD WIREABLE CONNECTOR, SPRING CAGE

TC05F200000071V – PG9



M12 STRAIGHT 5 PIN MALE FIELD WIREABLE CONNECTOR, SPRING CAGE

TA05F200000071V – PG9



M12 90° 5 PIN FEMALE FIELD WIREABLE CONNECTOR, SPRING CAGE

TD05F200000071V – PG9



M12 90° 5 PIN MALE FIELD WIREABLE CONNECTOR, SPRING CAGE

TB05F200000071V – PG9



BULK SUB-BUS CABLE

*NOTE

000550MGD0005000 – 50 Meter Length

0005A0MGD0005000 – 100 Meter Length

* Note:

Length of field wired cables should not exceed the maximum length of 30 meters for total sub-bus communications link. See appropriate technical manual for sub-bus length requirements. The cable assemblies and Bulk cable are the only approved cables for the G3 Sub-Bus link. See technical document TDG3SBWD1-0EN for proper installation and wiring of field wireable connectors.

Technical Data

TECHNICAL DATA	CABLE	CONNECTORS	BULK CABLE
Molded Body / Insert	TPU	Zinc - Nickel Plated	N/A
Coupling Nut	Zinc - Nickel Plated	Brass - Nickel Plated	N/A
Cable Jacket Material	PUR	N/A	Gray RAL 7001
Cable O.D.	6.70 mm	N/A	6.70 mm
Voltage Rating (Nominal)	60 Volts	60 Volts	60 Volts
Current Rating	4.0 Amps	4.0 Amps	4.0 Amps
Degree of Protection	IP65 (mated)	IP65 (mated)	IP65 (terminated)
Operating Temperature	-40° C - 80° C	-40° C - 80° C	-20° C - 75° C
Conductor Gauge	24 AWG Signal 22 AWG Power	26-20 AWG	24 AWG Signal 22 AWG Power
Bend Radius	67 mm	N/A	67 mm
No. of Bending Cycles	5 Million	N/A	5 Million

NUMATICS G3 Series EtherNet/IP™ Technical Manual

G3 Sub-Bus Field Wiring Directions

The purpose of this document is to instruct the end user of the proper wiring techniques required to make a G3 Sub-Bus cable from the available bulk cable and field wireable ends. The effectiveness of the resultant assembly remains on the end user and may have bearing on the proper functionality of the G3 Sub-Bus operation; please follow the manufacturer's Cable Assembly Procedure properly.

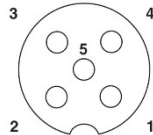

Cable Assembly Procedure

- Step No.1 Cut cable to desired length.
- Step No.2 Run cable through Pressure Nut and Housing.
- Step No.3 Strip cable jacket back 28mm (1.10") for straight connectors and 35mm (1.38") for 90° connectors.
- Step No.4 Remove shielding from end of wires back approximately 16mm (.630").
- Step No.5 Apply shielding foil provided, around the shortened end of the shielding.
- Step No.6 Strip individual conductors back approximately 11mm (.433").
- Step No.7 Push stranded wires into appropriate colored terminal.
- Step No.8 Attach the connector body onto the housing and tighten.
- Step No.9 Attach the pressure nut on the back side and tighten
- Step No.10 Confirm Continuity between all pins.

- 1 = Shield Wire (must be connected)
- 2 = Red
- 3 = Black
- 4 = White
- 5 = Blue

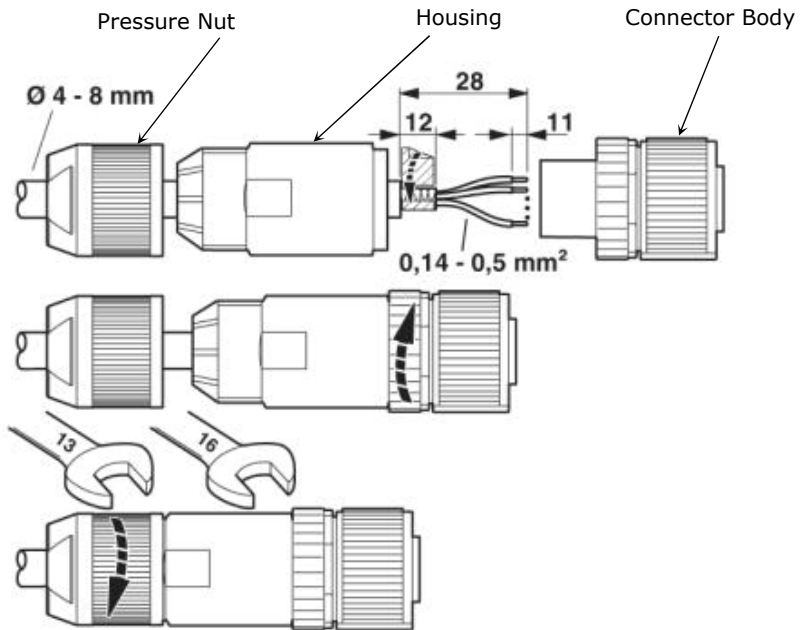
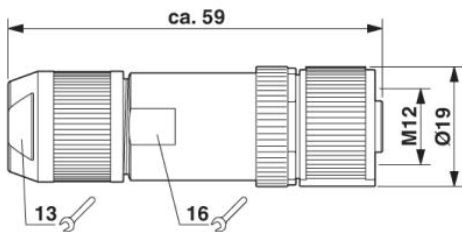

8. Digital I/O Module

8.1 Digital I/O Module Usage

The maximum number of modules that can be used on the Discrete I/O side of the manifold is 16. These modules can be centralized on the main fieldbus manifold, distributed or a combination of both. Modules can be connected in any combination of inputs, outputs and specialty up to the physical limitation of 16 modules.

Input Module Types

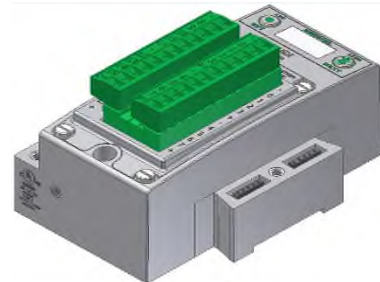

Output Module Types

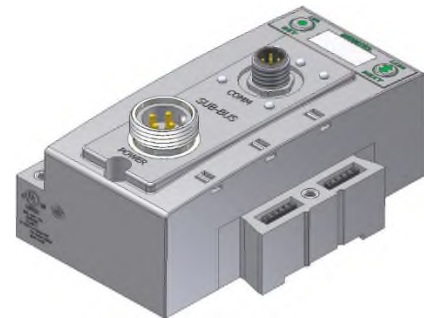

Input/Output Module Types



Valve Side Output Module Types



numatics G3 Series EtherNet/IP™ Technical Manual

8.2 I/O Module Technical Data

Module No.	Description	Connector Type	Current Limitation for Module	Current Limitation for connector	Current Limitation for manifold assy.
240-203	16 PNP Inputs	Terminal Strip	1.2A	.30A for each +24VDC terminal	4A for +24 Valves and Outputs 4A for +24 Node and Inputs
240-204	16 NPN Inputs				
240-205	16 PNP Inputs	M12	1.2A	.15A (Pin 1 to Pin 3)	
240-206	8 PNP Inputs	M12	1.2A	.15A (Pin 1 to Pin 3)	
240-207	16 PNP Outputs	M12	1.2A	.50A (Pin 3 to Pin 2/4)	
240-208	8 PNP Outputs	M12	1.2A	.50A (Pin 3 to Pin 2/4)	
240-209	16 NPN Inputs	M12	1.2A	.15A (Pin 1 to Pin 3)	
240-210	8 NPN Inputs	M12	1.2A	.15A (Pin 1 to Pin 3)	
240-211	8 PNP Input and 8 PNP Outputs	M12	1.2A	.50A / output connector (Pin 3 to Pin 2/4) .15A / input connector (Pin 1 to Pin 3)	
240-212 240-213 240-214 240-215	Analog I/O modules	M12	1.2A	.15A (Pin 1 to Pin 3)	
240-300	8 High Current Outputs	M12	8A (From Aux. Power Conn.)	2.0A / output connector (1.0A Pin 3 to Pin 2) (1.0A Pin 3 to Pin 4)	N/A
240-307	2 Analog Inputs and 2 High Current Analog Outputs	M12	4A (From Aux. Power Conn.)	2.0A (Pin 3 to Pin 4)	N/A
240-311	RTD	M12	1.2A	N/A	4A for +24 Valves and Outputs 4A for +24 Node and Inputs
240-316	8 PNP Inputs	Terminal Strip	1.2A	.30A for each +24VDC terminal	
240-323	16 PNP Inputs	Terminal Strip	1.2A	.30A for each +24VDC terminal	
240-330	16 PNP Outputs	Terminal Strip	1.2A	.50A / output connector	4A for +24 Node and Inputs
240-363	4 Analog Inputs and 4 High Current Analog Outputs	M12	8A (From Aux. Power Conn.)	2.0A (Pin 1 to Pin 3)	

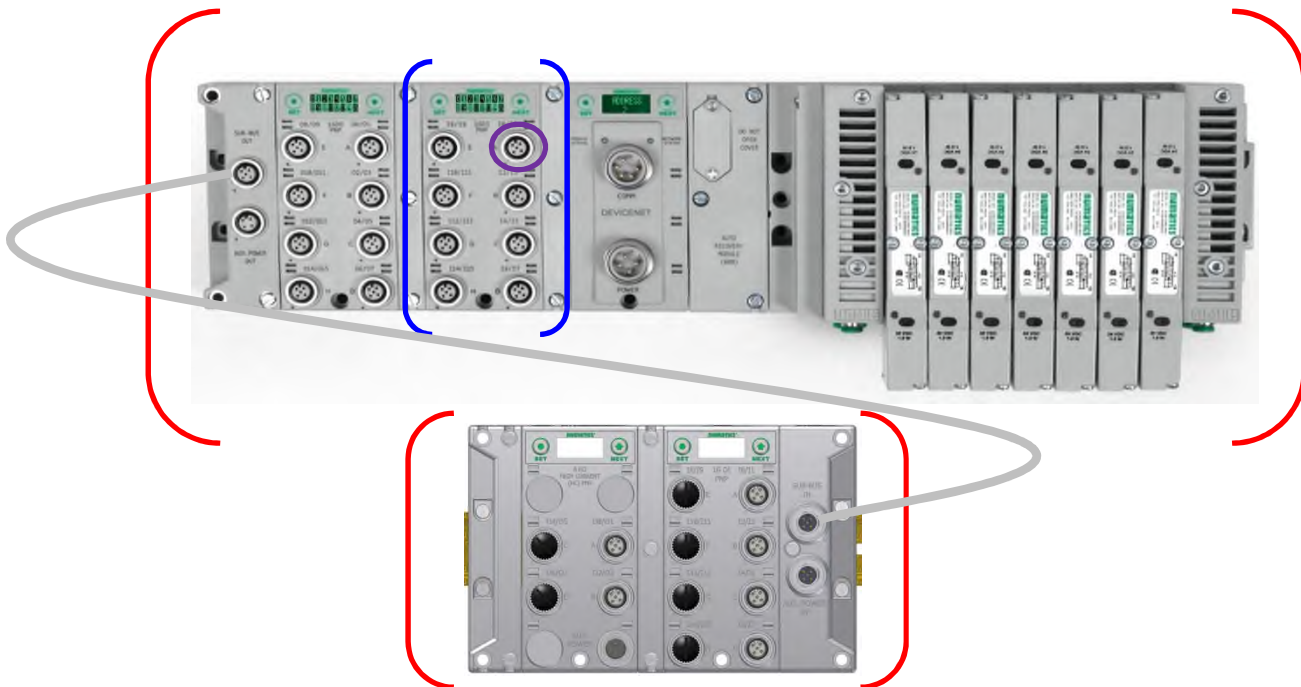

TDG3EPTM1-9EN 05/18
Subject to change without notice

numatics G3 Series EtherNet/IP™ Technical Manual

8.3 I/O Module Descriptions and Menus

Detail No.	Description
1	"Set" Button – used to navigate through user menus and set parameters
2	Module Function (I/O Type)
3	Alignment arrow for SPEEDCON connector
4	Bit Designation for I/O
5	"Next" Button – used to navigate through user menus and set parameters
6	Graphic Display
7	5 Pin M12 female I/O connector
8	Connector designation
9	Metal threads for SPEEDCON connector
10	Slot for text ID tags
11	Dust Cover
12	Mounting hole

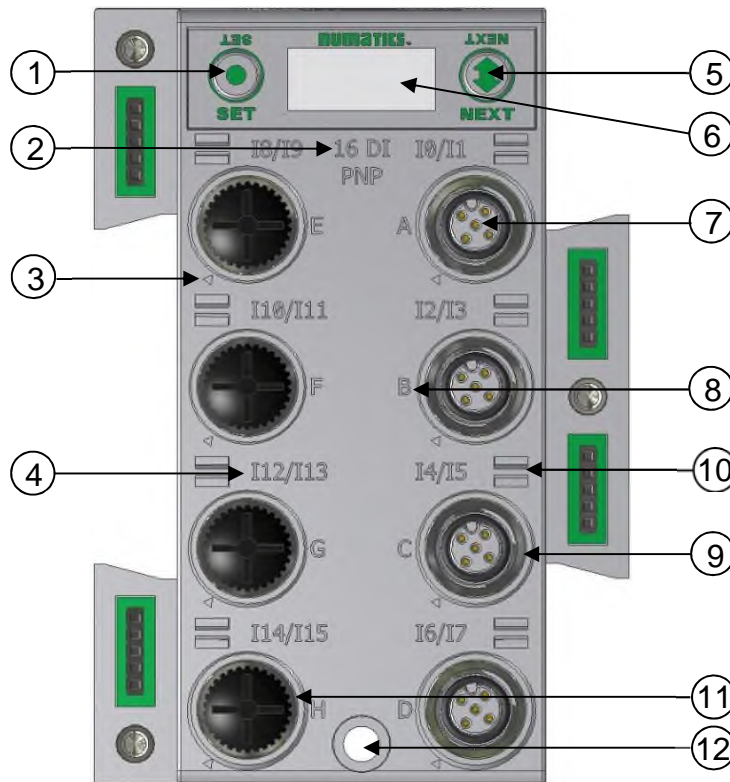

NOTE All dust covers must be tightened to a torque of 4-6 in. lbs. to maintain the IP65 integrity.

numatics G3 Series EtherNet/IP™ Technical Manual

8.4 Digital Input Modules

One Digital Input per Connector – M12 Female Modules

Module Part No.	I/O Type	Short Circuit Protection	Short Circuit Protection Status Bits	Input Points
240-210	NPN (Sinking)	YES – Visual	YES – Optional	8
240-206	PNP (Sourcing)			

Input Mapping								
BYTE	Bit 7	Bit 6	Bit 5	Bit 4	Bit 3	Bit 2	Bit 1	Bit 0
X (Required)	Input 7	Input 6	Input 5	Input 4	Input 3	Input 2	Input 1	Input 0
X+1 (Selectable)	Conn. H SCP Status	Conn. G SCP Status	Conn. F SCP Status	Conn. E SCP Status	Conn. D SCP Status	Conn. C SCP Status	Conn. B SCP Status	Conn. A SCP Status

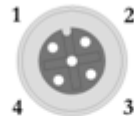

FEMALE

PIN 1= +24VDC (UNSW)
 PIN 2= NOT USED
 PIN 3= 0VDC (UNSW)
 PIN 4= INPUT 1

numatics G3 Series EtherNet/IP™ Technical Manual

Two Digital Inputs per Connector – M12 Female Modules

Module Part No.	I/O Type	Short Circuit Protection	Short Circuit Protection Status Bits	Input Points
240-209	NPN (Sinking)	YES – Visual	YES – Optional	16
240-205	PNP (Sourcing)			

Input Mapping								
BYTE	Bit 7	Bit 6	Bit 5	Bit 4	Bit 3	Bit 2	Bit 1	Bit 0
X (Required)	Input 7	Input 6	Input 5	Input 4	Input 3	Input 2	Input 1	Input 0
X+1 (Required)	Input 15	Input 14	Input 13	Input 12	Input 11	Input 10	Input 9	Input 8
X+2 (Selectable)	Conn. H SCP Status	Conn. G SCP Status	Conn. F SCP Status	Conn. E SCP Status	Conn. D SCP Status	Conn. C SCP Status	Conn. B SCP Status	Conn. A SCP Status

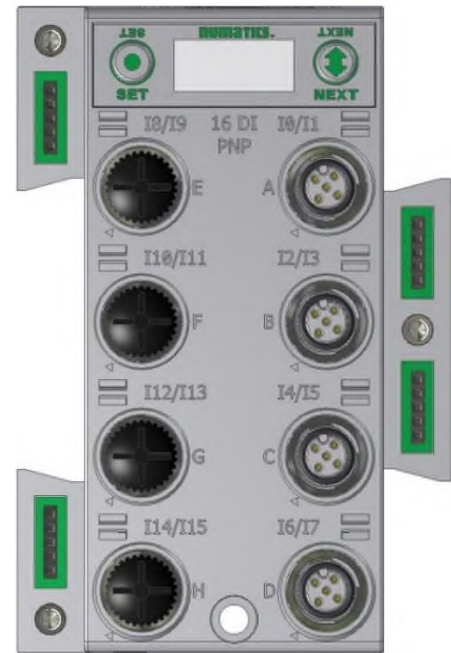

FEMALE

PIN 1= +24VDC (UNSW)
 PIN 2= INPUT 2
 PIN 3= 0VDC (UNSW)
 PIN 4= INPUT 1

numatics G3 Series EtherNet/IP™ Technical Manual

Sixteen Digital Inputs – Terminal Strip Modules

Specifications

- Wire Range: 12 to 24 AWG
- Strip Length: 7mm
- Tightening Torque: 0.5 Nm

Module Part No.	I/O Type	Short Circuit Protection	Short Circuit Protection Status Bits	Input Points
240-203	PNP (Sourcing)	YES Visual and Logical Status Bits	4 user enabled bits monitor Short Circuits on the four different + voltage connections of terminal strip	16
240-204	NPN (Sinking)			

Input Mapping								
BYTE	Bit 7	Bit 6	Bit 5	Bit 4	Bit 3	Bit 2	Bit 1	Bit 0
X (Required)	Input 7	Input 6	Input 5	Input 4	Input 3	Input 2	Input 1	Input 0
X+1 (Required)	Input 15	Input 14	Input 13	Input 12	Input 11	Input 10	Input 9	Input 8
X+2 (Selectable)	Allocated and Reserved	Allocated and Reserved	Allocated and Reserved	Allocated and Reserved	SCP Status 1 = Fault +D	SCP Status 1 = Fault +C	SCP Status 1 = Fault +B	SCP Status 1 = Fault +A

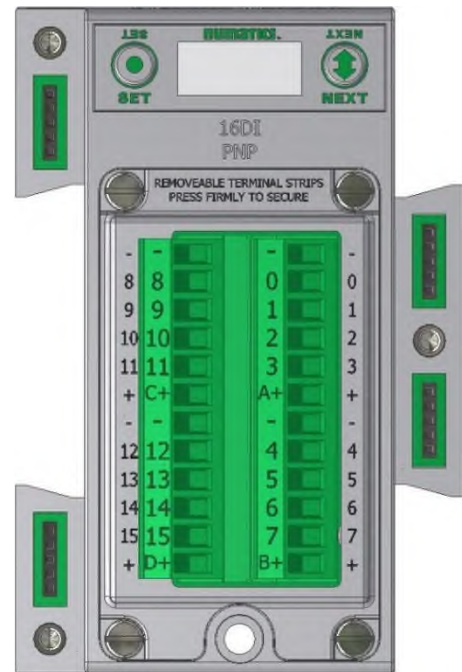
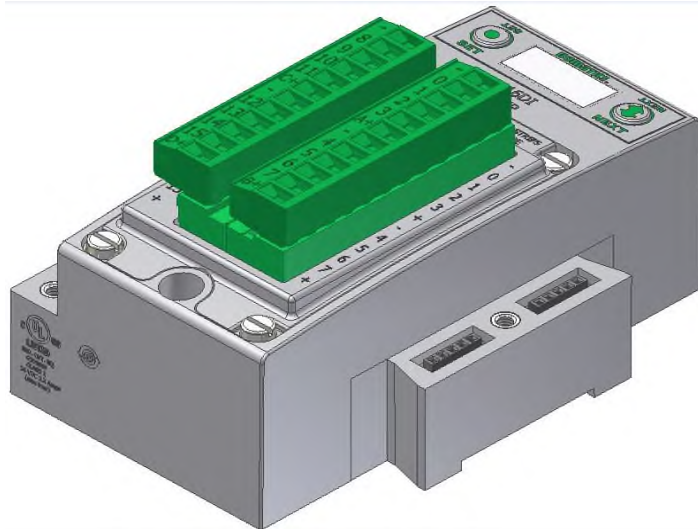

NUMATICS G3 Series EtherNet/IP™ Technical Manual

Eight Digital Inputs – Terminal Strip Modules

Specifications

- Wire Range: 12 to 24 AWG
- Strip Length: 7mm
- Tightening Torque: 0.5 Nm

Module Part No.	I/O Type	Short Circuit Protection	Short Circuit Protection Status Bits	Input Points
240-316	PNP (Sourcing)	YES	YES	8

Input Mapping								
BYTE	Bit 7	Bit 6	Bit 5	Bit 4	Bit 3	Bit 2	Bit 1	Bit 0
X	Input 7	Input 6	Input 5	Input 4	Input 3	Input 2	Input 1	Input 0
X+1 (Selectable)	Input 7 SCP Status	Input 6 SCP Status	Input 5 SCP Status	Input 4 SCP Status	Input 3 SCP Status	Input 2 SCP Status	Input 1 SCP Status	Input 0 SCP Status

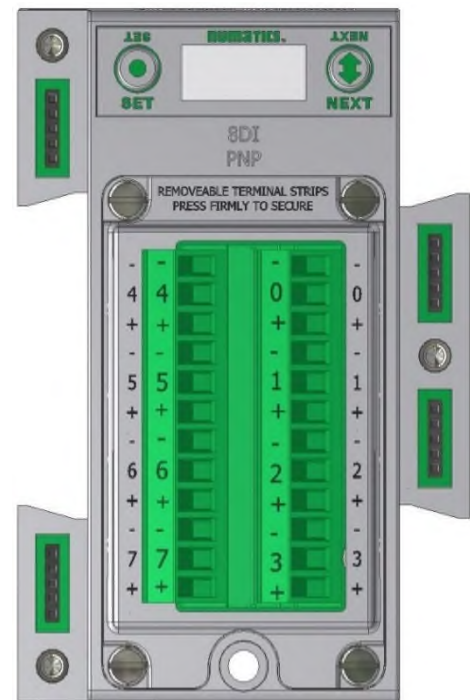
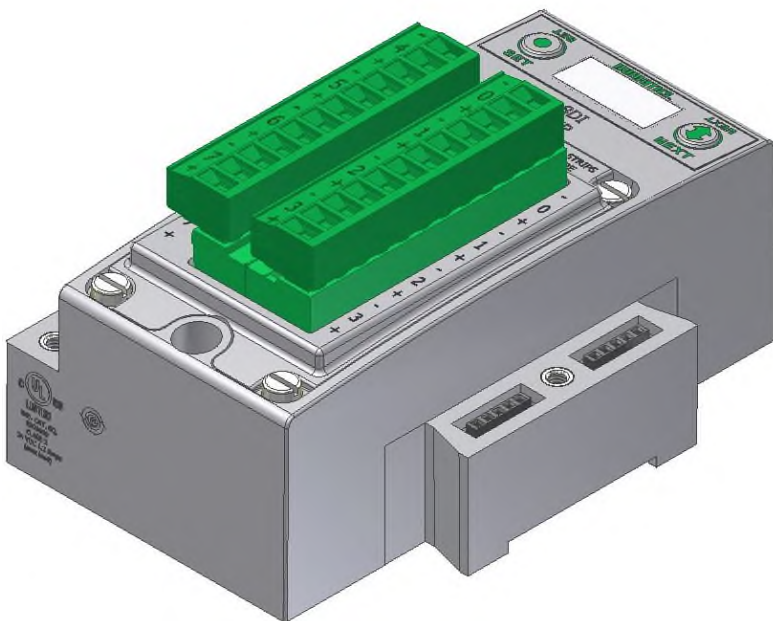

NUMATICS G3 Series EtherNet/IP™ Technical Manual

Intrinsically safe [Ex ia] NAMUR Compatible Input Module

One Digital Input per Connector – M12 Female

Input module is for use with NAMUR certified intrinsically safe (IS) sensors. The module can be placed in any G3 I/O position available, but must be used in conjunction with appropriate clips with partition plates (see picture on page 67). This module is for use with (IS) sensors (certified to EN 60947-5-6) where the sensor is placed within the hazardous area, (e.g. ATEX 0-20, 1-21, and 2-22). This [Ex ia] module is part of the G3 electronics platform, which is designed to reside outside of the hazardous environment or in Zone 2-22, inside of a cabinet with appropriate ingress protection. The partition plate clips, used between standard G3 modules and [Ex ia] modules, are required to maintain ATEX approval. The 8.2 V sensor supply for each input connector is short circuit protected.

Part Numbers and Mapping

Module Part No.	I/O Type	Short Circuit /Open Circuit Protection			Short Circuit /Open Circuit Present Status Bits			Input Points
240-320	NAMUR	YES - Visual			YES - Optional			8
Input Mapping								
BYTE	Bit 7	Bit 6	Bit 5	Bit 4	Bit 3	Bit 2	Bit 1	Bit 0
X (Required)	Input 7	Input 6	Input 5	Input 4	Input 3	Input 2	Input 1	Input 0
X+1 (Selectable)	Conn. H SC Status	Conn. G SC Status	Conn. F SC Status	Conn. E SC Status	Conn. D SC Status	Conn. C SC Status	Conn. B SC Status	Conn. A SC Status
X+2 (Selectable)	Conn. H Open Status	Conn. G Open Status	Conn. F Open Status	Conn. E Open Status	Conn. D Open Status	Conn. C Open Status	Conn. B Open Status	Conn. A Open Status

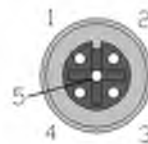
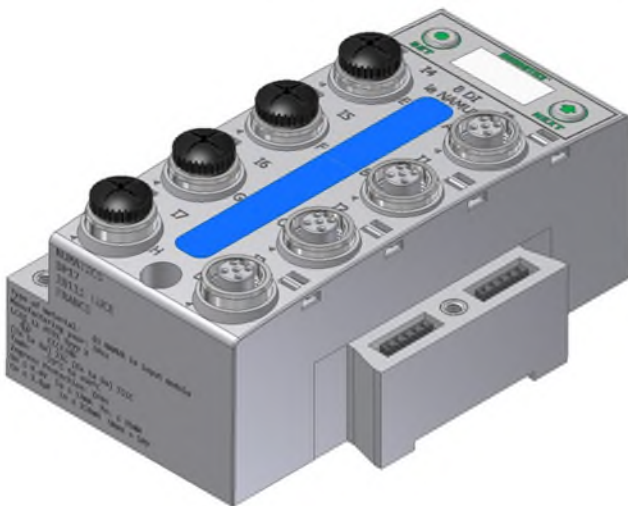

FEMALE
 PIN 1 = SENSOR +
 PIN 2 = SENSOR -
 PIN 3 = Not Connected
 PIN 4 = Not Connected
 PIN 5 = Not Connected

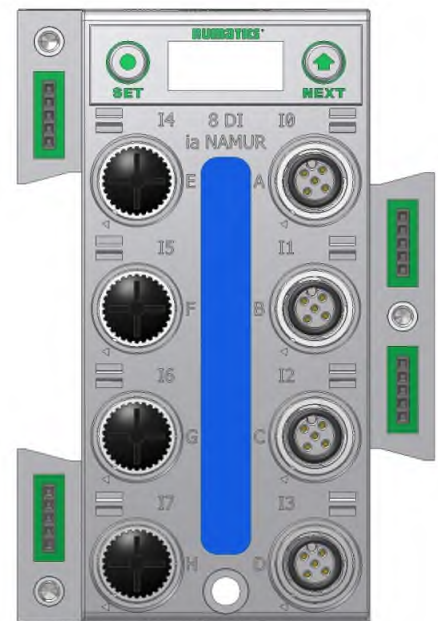

NUMATICS G3 Series EtherNet/IP™ Technical Manual

Intrinsically safe [Ex ia] NAMUR Compatible Input terminal strip module

Module Part No.	I/O Type	Short Circuit /Open Circuit Protection	Short Circuit /Open Circuit Present Status Bits	Input Points
240-322	NAMUR	YES - Visual	YES - Optional	8

Input Mapping								
BYTE	Bit 7	Bit 6	Bit 5	Bit 4	Bit 3	Bit 2	Bit 1	Bit 0
X (Required)	Input 7	Input 6	Input 5	Input 4	Input 3	Input 2	Input 1	Input 0
X+1 (Selectable)	Conn. H SC Status	Conn. G SC Status	Conn. F SC Status	Conn. E SC Status	Conn. D SC Status	Conn. C SC Status	Conn. B SC Status	Conn. A SC Status
X+2 (Selectable)	Conn. H Open Status	Conn. G Open Status	Conn. F Open Status	Conn. E Open Status	Conn. D Open Status	Conn. C Open Status	Conn. B Open Status	Conn. A Open Status

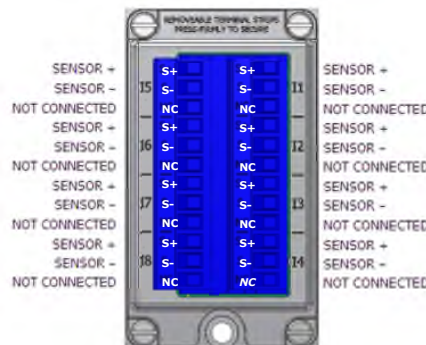
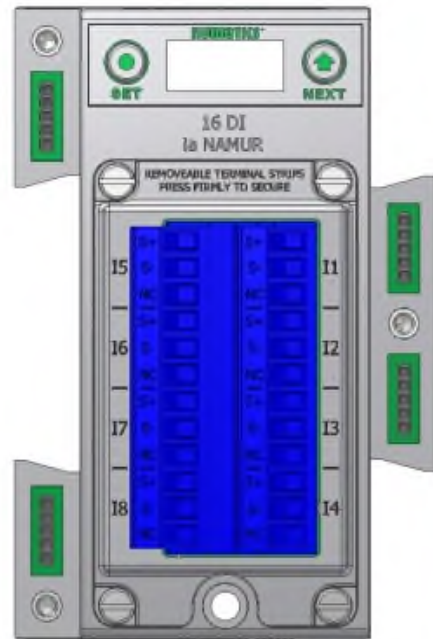
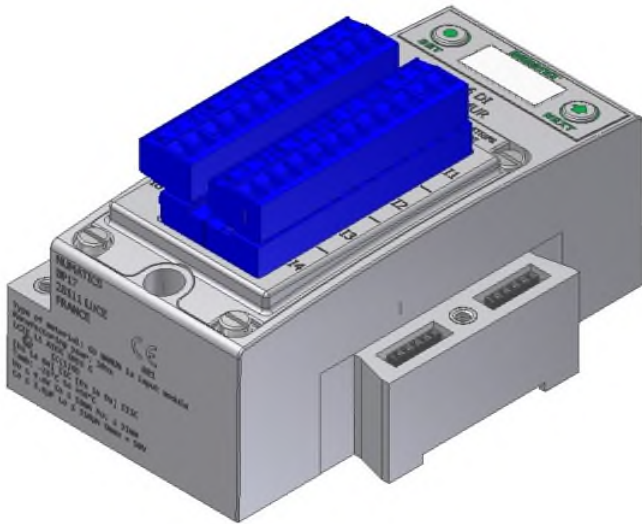

NUMATICS G3 Series EtherNet/IP™ Technical Manual

Intrinsically safe [Ex ia] Support Modules

Mechanical isolation between standard and [Ex ia] modules is mandatory to fulfill ATEX certification. Clips with Partition Plates are available to achieve the required isolation.

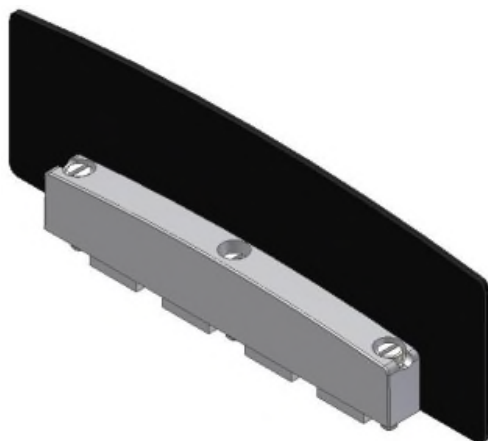

G3 [Ex ia] Clip 240-317

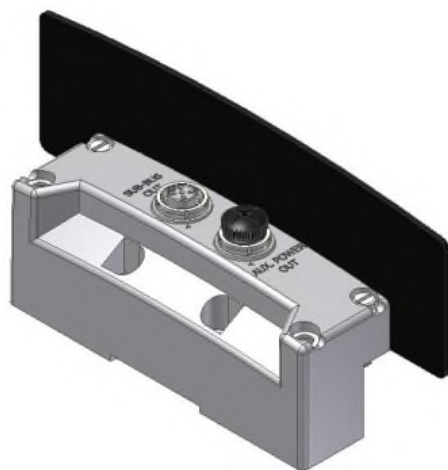

G3 [Ex ia] Sub-Bus Out 240-318

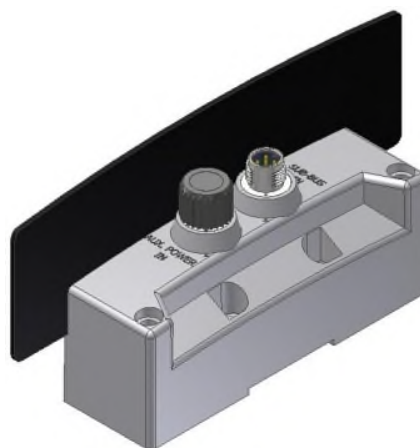

G3 [Ex ia] Sub-Bus In 240-319

NUMATICS G3 Series EtherNet/IP™ Technical Manual

19 Pin M23 Input Module

The 19 Pin M23 Input module is for use with any Input block available from Phoenix Contact, Turck, Brad Harrison, etc. It can also be used with a single ended 19 Pin Cable.

Part Numbers and Mapping

Module Part No.	I/O Type	Short Circuit /Open Circuit Protection	Short Circuit /Open Circuit Present Status Bits	Input Points
240-323	Digital	YES - Visual	YES - Optional	16

Input Mapping								
BYTE	Bit 7	Bit 6	Bit 5	Bit 4	Bit 3	Bit 2	Bit 1	Bit 0
X (Required)	Input 7	Input 6	Input 5	Input 4	Input 3	Input 2	Input 1	Input 0
X+1	Input 15	Input 14	Input 13	Input 12	Input 11	Input 10	Input 9	Input 8
X+2 (Selectable)	Short Circuit	Short Circuit	Short Circuit	Short Circuit	Short Circuit	Short Circuit	Short Circuit	Short Circuit

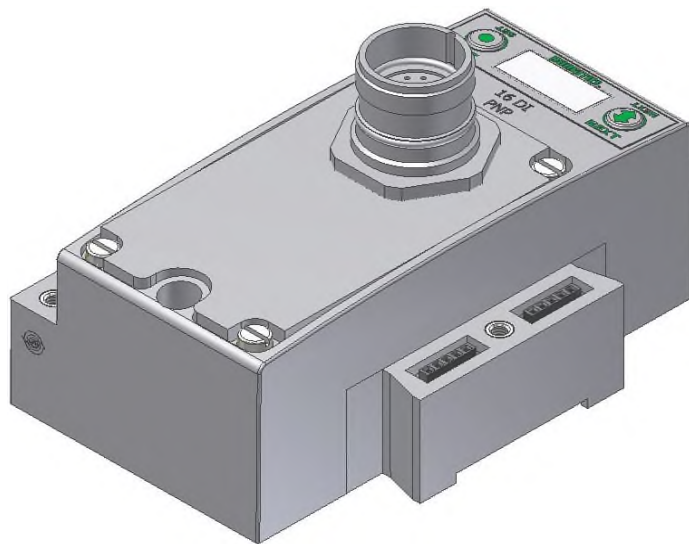

Pin Out Information

- | | |
|-------------------|-------------------|
| Pin 1 = Input 14 | Pin 11 = Input 12 |
| Pin 2 = Input 10 | Pin 12 = P.E. |
| Pin 3 = Input 6 | Pin 13 = Input 11 |
| Pin 4 = Input 3 | Pin 14 = Input 7 |
| Pin 5 = Input 2 | Pin 15 = Input 0 |
| Pin 6 = 0 VDC | Pin 16 = Input 4 |
| Pin 7 = Input 1 | Pin 17 = Input 8 |
| Pin 8 = Input 5 | Pin 18 = Input 15 |
| Pin 9 = Input 9 | Pin 19 = + 24 VDC |
| Pin 10 = Input 13 | |

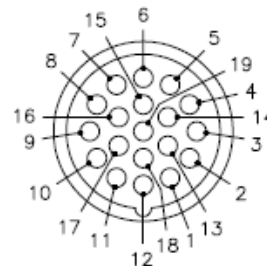

numatics G3 Series EtherNet/IP™ Technical Manual

8.5 Digital Output Modules

One Digital Output per Connector - M12 Female Modules

Module Part No.	I/O Type	Short Circuit Protection	Short Circuit Protection Status Bits	Output Points
240-208	PNP (Sourcing)	YES – Visual	YES (8) – Optional	8

Output Mapping								
BYTE	Bit 7	Bit 6	Bit 5	Bit 4	Bit 3	Bit 2	Bit 1	Bit 0
X (Required)	Output 7	Output 6	Output 5	Output 4	Output 3	Output 2	Output 1	Output 0
Input Mapping								
BYTE	Bit 7	Bit 6	Bit 5	Bit 4	Bit 3	Bit 2	Bit 1	Bit 0
X	Output 7 Status	Output 6 Status	Output 5 Status	Output 4 Status	Output 3 Status	Output 2 Status	Output 1 Status	Output 0 Status

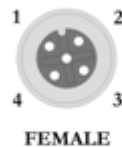

PIN 1= +24VDC (SW)
 PIN 2= NOT USED
 PIN 3= 0VDC (SW)
 PIN 4= OUTPUT 1

numatics G3 Series EtherNet/IP™ Technical Manual

Two Digital Outputs per Connector - M12 Female Modules

Module Part No.	I/O Type	Short Circuit Protection	Short Circuit Protection Status Bits	Output Points
240-207	PNP (Sourcing)	YES – Visual	YES (8) – Optional	16

Output Mapping								
BYTE	Bit 7	Bit 6	Bit 5	Bit 4	Bit 3	Bit 2	Bit 1	Bit 0
X (Required)	Output 7	Output 6	Output 5	Output 4	Output 3	Output 2	Output 1	Output 0
X+1 (Required)	Output 15	Output 14	Output 13	Output 12	Output 11	Output 10	Output 9	Output 8
Input Mapping								
BYTE	Bit 7	Bit 6	Bit 5	Bit 4	Bit 3	Bit 2	Bit 1	Bit 0
X (Selectable)	Output 7 Status	Output 6 Status	Output 5 Status	Output 4 Status	Output 3 Status	Output 2 Status	Output 1 Status	Output 0 Status
X+1 (Selectable)	Output 15 Status	Output 14 Status	Output 13 Status	Output 12 Status	Output 11 Status	Output 10 Status	Output 9 Status	Output 8 Status



PIN 1= +24VDC (SW)
 PIN 2= OUTPUT 2
 PIN 3= 0VDC (SW)
 PIN 4= OUTPUT 1

numatics G3 Series EtherNet/IP™ Technical Manual

Sixteen Digital Outputs – Terminal Strip Modules

Specifications

- Wire Range: 12 to 24 AWG
- Strip Length: 7mm
- Tightening Torque: 0.5 Nm

Module Part No.	I/O Type	Short Circuit Protection	Short Circuit Protection Status Bits	Output Points
240-330	PNP (Sourcing)	YES	YES	16

Output Mapping								
BYTE	Bit 7	Bit 6	Bit 5	Bit 4	Bit 3	Bit 2	Bit 1	Bit 0
X	Output 7	Output 6	Output 5	Output 4	Output 3	Output 2	Output 1	Output 0
X+1	Output 15	Output 14	Output 13	Output 12	Output 11	Output 10	Output 9	Output 8
Input Mapping								
BYTE	Bit 7	Bit 6	Bit 5	Bit 4	Bit 3	Bit 2	Bit 1	Bit 0
X (Selectable)	Output 7 Status	Output 6 Status	Output 5 Status	Output 4 Status	Output 3 Status	Output 2 Status	Output 1 Status	Output 0 Status
X (Selectable)	Output 15 Status	Output 14 Status	Output 13 Status	Output 12 Status	Output 11 Status	Output 10 Status	Output 9 Status	Output 8 Status

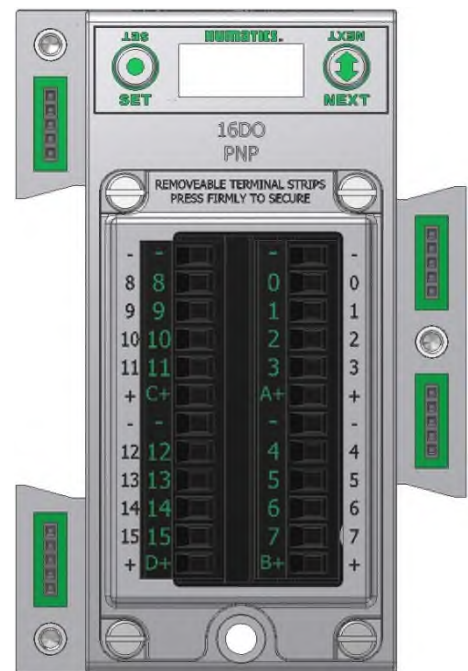
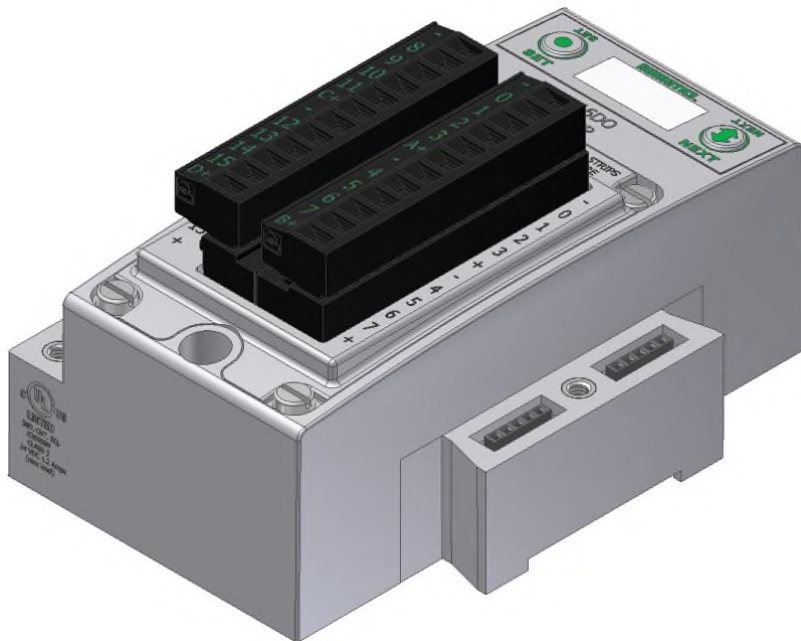

numatics G3 Series EtherNet/IP™ Technical Manual

Two Digital High Current Outputs per Connector - M12 Female Modules

The high current output module is to be used with output devices requiring between 0.5 and 1.0 Amps. Each connector incorporates two outputs that are capable of sourcing 1.0 Amp per output.

Module Part No.	I/O Type		Short Circuit Protection		Short Circuit Protection Status Bits		Output Points	
240-300	PNP (Sourcing)		YES - Visual		YES (8) - Optional		8	
Output Mapping								
BYTE	Bit 7	Bit 6	Bit 5	Bit 4	Bit 3	Bit 2	Bit 1	Bit 0
X (Required)	Output 7	Output 6	Output 5	Output 4	Output 3	Output 2	Output 1	Output 0
Input Mapping								
BYTE	Bit 7	Bit 6	Bit 5	Bit 4	Bit 3	Bit 2	Bit 1	Bit 0
X (Selectable)	Output 7 Status	Output 6 Status	Output 5 Status	Output 4 Status	Output 3 Status	Output 2 Status	Output 1 Status	Output 0 Status

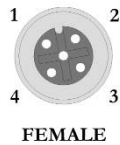
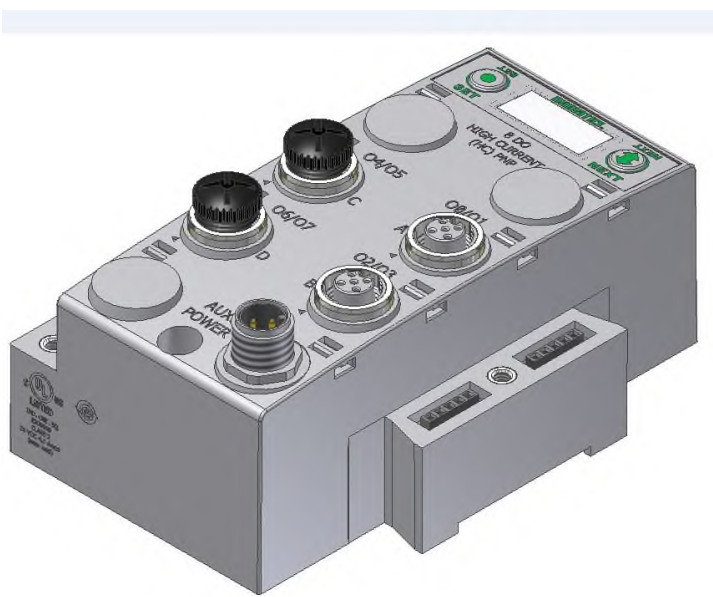

FEMALE
 PIN 1= +24VDC (SW)
 PIN 2= OUTPUT 2
 PIN 3= 0VDC (SW)
 PIN 4= OUTPUT 1

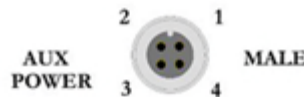

MALE
 PIN 1 = +24 VDC (For Conn A, B)
 PIN 2 = +24 VDC (For Conn C, D)
 PIN 3 = 0 VDC (For Conn A, B, C, D)
 PIN 4 = 0 VDC (For Conn A, B, C, D)

numatics G3 Series EtherNet/IP™ Technical Manual

8.6 Digital Input/Output Modules

Two Digital I/O per Connector - 12mm Female Modules

Module Part No.	I/O Type	Short Circuit Protection	Short Circuit Protection Status Bits	Output Points	Input Points
240-211	PNP (Sourcing)	YES – Visual	YES (8) – Optional	8	8

Output Mapping								
BYTE	Bit 7	Bit 6	Bit 5	Bit 4	Bit 3	Bit 2	Bit 1	Bit 0
X (Required)	Output 7	Output 6	Output 5	Output 4	Output 3	Output 2	Output 1	Output 0
Input Mapping								
BYTE	Bit 7	Bit 6	Bit 5	Bit 4	Bit 3	Bit 2	Bit 1	Bit 0
X (Required)	Input 7	Input 6	Input 5	Input 4	Input 3	Input 2	Input 1	Input 0
X+1 (Selectable)	Allocated and Reserved	Allocated and Reserved	Allocated and Reserved	Allocated and Reserved	Conn. D SCP Status	Conn. C SCP Status	Conn. B SCP Status	Conn. A SCP Status
X+2 (Selectable)	Output 7 Status Bit	Output 6 Status Bit	Output 5 Status Bit	Output 4 Status Bit	Output 3 Status Bit	Output 2 Status Bit	Output 1 Status Bit	Output 0 Status Bit



CONNECTORS E, F, G, & H

- PIN 1= +24VDC (SW)
- PIN 2= OUTPUT 2
- PIN 3= 0VDC (SW)
- PIN 4= OUTPUT 1

CONNECTORS A, B, C, & D

- PIN 1= +24VDC (UNSW)
- PIN 2= INPUT 2
- PIN 3= 0VDC (UNSW)
- PIN 4= INPUT 1

numatics G3 Series EtherNet/IP™ Technical Manual

One Analog Input + One Analog Output per Connector – M12 Female Modules

Module Part No.	Signal Type	Short Circuit Protection	Short Circuit / Power Present Status Bits	Input Channels	Output Channels
240-363	4-20 mA	YES	YES (4) – Selectable	4	4

Output Mapping								
BYTE	Bit 7	Bit 6	Bit 5	Bit 4	Bit 3	Bit 2	Bit 1	Bit 0
X (Required)	Output No. 1	Output No. 1	Output No. 1	Output No. 1	Output No. 1	Output No. 1	Output No. 1	Output No. 1 (LSB)
X+1 (Required)	Output No. 1 (MSB)	Output No. 1	Output No. 1	Output No. 1	Output No. 1	Output No. 1	Output No. 1	Output No. 1
X+2 (Required)	Output No. 2	Output No. 2	Output No. 2	Output No. 2	Output No. 2	Output No. 2	Output No. 2	Output No. 2 (LSB)
X+3 (Required)	Output No. 2 (MSB)	Output No. 2	Output No. 2	Output No. 2	Output No. 2	Output No. 2	Output No. 2	Output No. 2
X+4 (Required)	Output No. 3	Output No. 3	Output No. 3	Output No. 3	Output No. 3	Output No. 3	Output No. 3	Output No. 3 (LSB)
X+5 (Required)	Output No. 3 (MSB)	Output No. 3	Output No. 3	Output No. 3	Output No. 3	Output No. 3	Output No. 3	Output No. 3
X+6 (Required)	Output No. 4	Output 4	Output No. 4	Output No. 4	Output No. 4	Output No. 4	Output No. 4	Output No. 4 (LSB)
X+7 (Required)	Output No. 4 (MSB)	Output 4	Output No. 4	Output No. 4	Output No. 4	Output No. 4	Output No. 4	Output No. 4
Input Mapping								
BYTE	Bit 7	Bit 6	Bit 5	Bit 4	Bit 3	Bit 2	Bit 1	Bit 0
X (Required)	Input No. 1	Input No. 1	Input No. 1	Input No. 1	Input No. 1	Input No. 1	Input No. 1	Input No. 1 (LSB)
X+1 (Required)	Input No. 1 (MSB)	Input No. 1	Input No. 1	Input No. 1	Input No. 1	Input No. 1	Input No. 1	Input No. 1
X+2 (Required)	Input No. 2	Input No. 2	Input No. 2	Input No. 2	Input No. 2	Input No. 2	Input No. 2	Input No. 2 (LSB)
X+3 (Required)	Input No. 2 (MSB)	Input No. 2	Input No. 2	Input No. 2	Input No. 2	Input No. 2	Input No. 2	Input No. 2
X+4 (Required)	Input No. 3	Input No. 3	Input No. 3	Input No. 1	Input No. 1	Input No. 1	Input No. 1	Input No. 1 (LSB)
X+5 (Required)	Input No. 3 (MSB)	Input No. 3	Input No. 3	Input No. 1	Input No. 1	Input No. 1	Input No. 1	Input No. 1
X+6 (Required)	Input No. 4	Input No. 4	Input No. 4	Input No. 2	Input No. 2	Input No. 2	Input No. 2	Input No. 2 (LSB)
X+7 (Required)	Input No. 4 (MSB)	Input No. 4	Input No. 4	Input No. 2	Input No. 2	Input No. 2	Input No. 2	Input No. 2

numatics™ G3 Series EtherNet/IP™ Technical Manual

Module Part No.	Signal Type	Short Circuit Protection	Short Circuit / Power Present Status Bits	Input Channels	Output Channels
240-363	4-20 mA	YES	YES (4) – Selectable	4	4

Input Mapping (continued)								
BYTE	Bit 7	Bit 6	Bit 5	Bit 4	Bit 3	Bit 2	Bit 1	Bit 0
X+8 (Selectable)	Allocated and Reserved	Allocated and Reserved	Allocated and Reserved	Allocated and Reserved	Power/Short Status for Conn. D	Power/Short Status for Conn. C	Power/Short Status for Conn. B	Power/Short Status for Conn. A
X+9 (Selectable)	High Alarm for Conn. D Input	Low Alarm for Conn. D Input	High Alarm for Conn. C Input	Low Alarm for Conn. C Input	High Alarm for Conn. B Input	Low Alarm for Conn. B Input	High Alarm for Conn. A Input	Low Alarm for Conn. A Input
X+10 (Selectable)	High Alarm for Conn. D Output	Low Alarm for Conn. D Output	High Alarm for Conn. C Output	Low Alarm for Conn. C Output	High Alarm for Conn. B Output	Low Alarm for Conn. B Output	High Alarm for Conn. A Output	Low Alarm for Conn. A Output

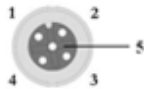

Pin 1 = +24VDC
 Pin 2 = Output
 Pin 3 = 0VDC
 Pin 4 = Input
 Pin 5 = Not Used

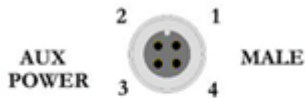

Pin 1 = +24 VDC (For Conn A, B)
 Pin 2 = +24 VDC (For Conn C, D)
 Pin 3 = 0 VDC (For Conn A, B, C, D)
 Pin 4 = 0 VDC (For Conn A, B, C, D)



NUMATICS G3 Series EtherNet/IP™ Technical Manual

Internal or Aux. Power Select (240-363 Only)

Analog devices connected to the 240-363 can be powered from the Aux. Power supply port (Internal Power Disabled) or from the module backplane (Internal Power Enabled). This is selected through the "Internal Power Menu" as shown. Channels A/B and C/D are controlled independently.

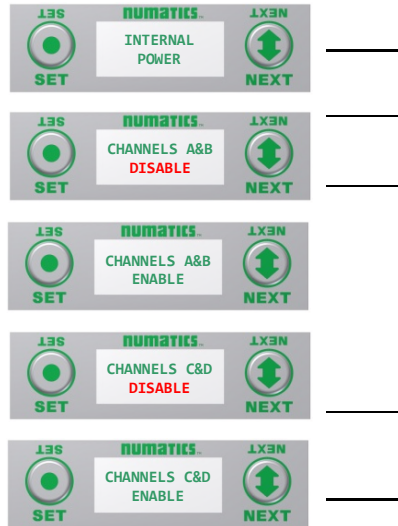

Internal Power Settings

1. Press the SET button to enter the INTERNAL POWER menu
2. CHANNEL A & B DISABLE
3. Press the NEXT button to scroll through the choices to enable or disable the feature.
 - j. ENABLED (Factory Default)
 - k. DISABLED
 - l. RETURN (this will return you to the main menu)

Press the SET button to confirm your choice

4. CHANNEL C & D DISABLE
5. Press the NEXT button to scroll through the choices to enable or disable the feature.
 - m. ENABLED (Factory Default)
 - n. DISABLED
 - o. RETURN (this will return you to the main menu)

Press the SET button to confirm your choice



Power Source	Current Limitation for Module	Current Limitation for Connector
Aux Power	8A (From Aux. Power Conn.)	2.0A / output connector (2.0A Pin 1 to Pin 3)
Internal Power	1.2A (from Backplane)	.15A (Pin 1 to Pin 3)

NUMATICS G3 Series EtherNet/IP™ Technical Manual

8.7 Sub-bus Valve Module

Used to control a distributed valve manifold through the Sub-Bus. See page 53 for more information.

Module Part No.	I/O Type	Short Circuit Protection	Short Circuit Protection Status Bits	Output Points
240-241	NPN (Sinking)	YES – Visual	YES (32) – Optional	32

Output Mapping								
BYTE	Bit 7	Bit 6	Bit 5	Bit 4	Bit 3	Bit 2	Bit 1	Bit 0
X (Required)	Valve Coil No. 7	Valve Coil No. 6	Valve Coil No. 5	Valve Coil No. 4	Valve Coil No. 3	Valve Coil No. 2	Valve Coil No. 1	Valve Coil No. 0
X+1 (Selectable)	Valve Coil No. 15	Valve Coil No. 14	Valve Coil No. 13	Valve Coil No. 12	Valve Coil No. 11	Valve Coil No. 10	Valve Coil No. 9	Valve Coil No. 8
X+2 (Selectable)	Valve Coil No. 23	Valve Coil No. 22	Valve Coil No. 21	Valve Coil No. 20	Valve Coil No. 19	Valve Coil No. 18	Valve Coil No. 17	Valve Coil No. 16
X+3 (Selectable)	Valve Coil No. 31	Valve Coil No. 30	Valve Coil No. 29	Valve Coil No. 28	Valve Coil No. 27	Valve Coil No. 26	Valve Coil No. 25	Valve Coil No. 24
Diagnostics								
BYTE	Bit 7	Bit 6	Bit 5	Bit 4	Bit 3	Bit 2	Bit 1	Bit 0
X (Selectable)	Coil 7 Status	Coil 6 Status	Coil 5 Status	Coil 4 Status	Coil 3 Status	Coil 2 Status	Coil 1 Status	Coil 0 Status
X+1 (Selectable)	Coil 15 Status	Coil 14 Status	Coil 13 Status	Coil 12 Status	Coil 11 Status	Coil 10 Status	Coil 9 Status	Coil 8 Status
X+2 (Selectable)	Coil 23 Status	Coil 22 Status	Coil 21 Status	Coil 20 Status	Coil 19 Status	Coil 18 Status	Coil 17 Status	Coil 16 Status
X+3 (Selectable)	Coil 31 Status	Coil 30 Status	Coil 29 Status	Coil 28 Status	Coil 27 Status	Coil 26 Status	Coil 25 Status	Coil 24 Status

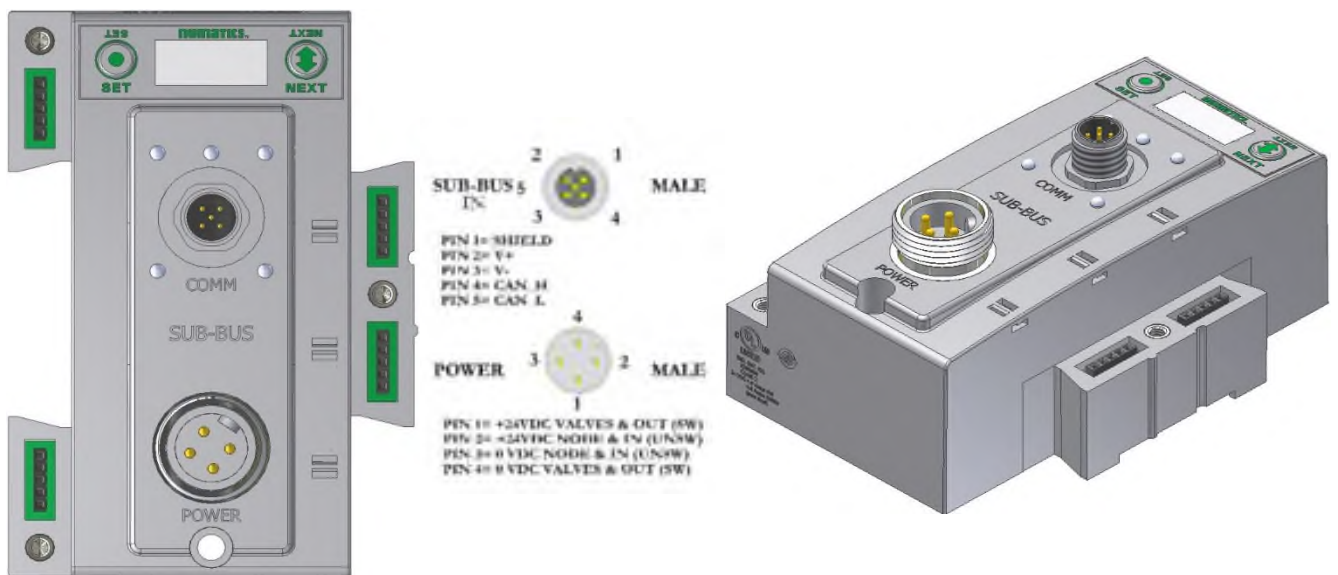

numatics G3 Series EtherNet/IP™ Technical Manual

8.8 Sub-bus Valve Module without Distribution and I/O

Used to control a distributed valve manifold through the Sub-Bus. See page 53 for more information.

Module Part No.	I/O Type	Short Circuit Protection	Short Circuit Protection Status Bits	Output Points
P580AEDS4010A00	NPN (Sinking)	YES – Visual	YES (32) – Optional	32

Output Mapping								
BYTE	Bit 7	Bit 6	Bit 5	Bit 4	Bit 3	Bit 2	Bit 1	Bit 0
X (Required)	Valve Coil No. 7	Valve Coil No. 6	Valve Coil No. 5	Valve Coil No. 4	Valve Coil No. 3	Valve Coil No. 2	Valve Coil No. 1	Valve Coil No. 0
X+1 (Selectable)	Valve Coil No. 15	Valve Coil No. 14	Valve Coil No. 13	Valve Coil No. 12	Valve Coil No. 11	Valve Coil No. 10	Valve Coil No. 9	Valve Coil No. 8
X+2 (Selectable)	Valve Coil No. 23	Valve Coil No. 22	Valve Coil No. 21	Valve Coil No. 20	Valve Coil No. 19	Valve Coil No. 18	Valve Coil No. 17	Valve Coil No. 16
X+3 (Selectable)	Valve Coil No. 31	Valve Coil No. 30	Valve Coil No. 29	Valve Coil No. 28	Valve Coil No. 27	Valve Coil No. 26	Valve Coil No. 25	Valve Coil No. 24
Diagnostics								
BYTE	Bit 7	Bit 6	Bit 5	Bit 4	Bit 3	Bit 2	Bit 1	Bit 0
X (Selectable)	Coil 7 Status	Coil 6 Status	Coil 5 Status	Coil 4 Status	Coil 3 Status	Coil 2 Status	Coil 1 Status	Coil 0 Status
X+1 (Selectable)	Coil 15 Status	Coil 14 Status	Coil 13 Status	Coil 12 Status	Coil 11 Status	Coil 10 Status	Coil 9 Status	Coil 8 Status
X+2 (Selectable)	Coil 23 Status	Coil 22 Status	Coil 21 Status	Coil 20 Status	Coil 19 Status	Coil 18 Status	Coil 17 Status	Coil 16 Status
X+3 (Selectable)	Coil 31 Status	Coil 30 Status	Coil 29 Status	Coil 28 Status	Coil 27 Status	Coil 26 Status	Coil 25 Status	Coil 24 Status

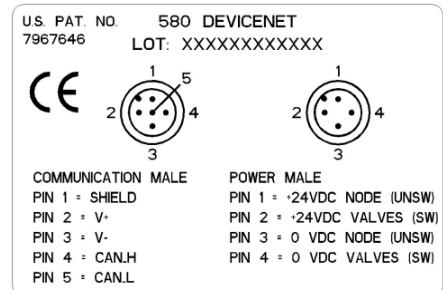
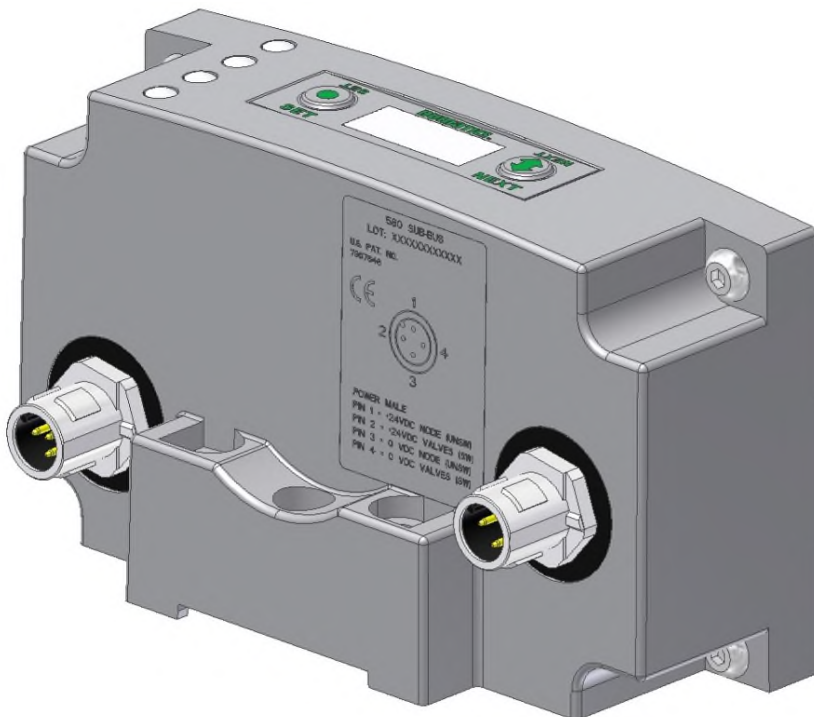

TDG3EPTM1-9EN 05/18
 Subject to change without notice

NUMATICS G3 Series EtherNet/IP™ Technical Manual

8.9 Valve Side Digital Output Module

The valve side output module is used to distribute available valve side output points (i.e. when valves are located away from the rest of the electronics). These modules go to the right of the G3 valve adapter. The 16-bit output module utilizes the last 16 output bits on the valve side of the manifold (bits 16-31).

This module is not available with the 501, 502 or 503 series valves.

Sixteen Outputs per Connector - Sub-D 25 Pin Female Module

Module Part No.	I/O Type	Short Circuit Protection	Internal Status Bits	Output Points	Module Size
239-1713	NPN (Sinking)	Yes	16 - Optional	16	Narrow

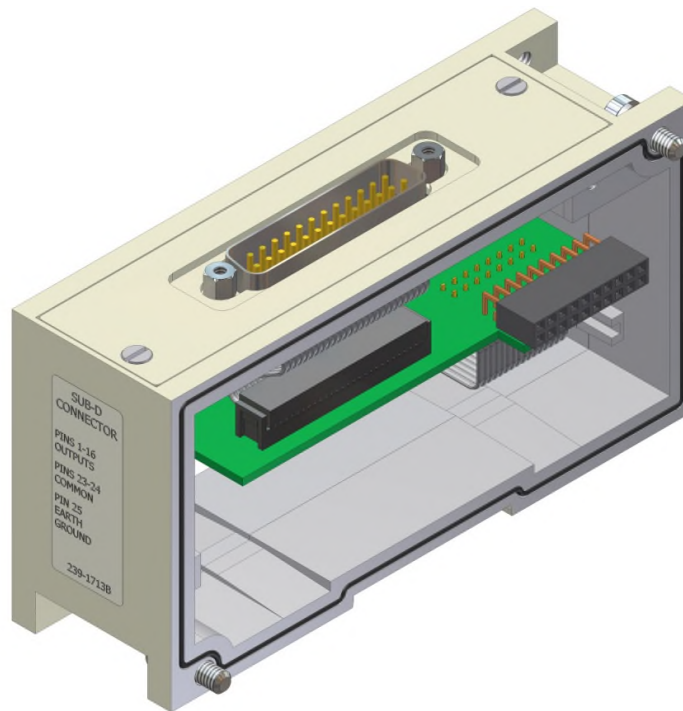

9. Analog I/O Modules

9.1 Analog I/O Module Rules

The analog I/O modules follow the same rules as the digital I/O modules. The maximum total number of modules on the Sub-Bus is 16. The analog boards allow the user to control devices using an analog signal. The analog modules also allow the user to relay analog information from input devices. These modules are available in two analog signal types: 0-10 V and 4-20 mA. These two signal types are offered in two different I/O configurations: 2 analog input channels/ 2 analog outputs channels and 4 analog input channels.

Four I/O - 12mm Female Modules

Specifications

- Input Resolution: 16 bit (65,536 Counts),
- Output Resolution: 16 bit (65,536 Counts)
- Settling Time: 3 ms Max
- Absolute Precision: ≤ 1.0% of Signal
- Voltage Input Impedance: 0-10VDC – 40K Ohms
- Current Input Impedance: 250 Ohms
- Input Cutoff Frequency: 100 Hz

<i>Module Part No.</i>	<i>Signal Type</i>	<i>Input Points</i>	<i>Output Points</i>	<i>Short Circuit Protection</i>
240-212	0 - 10V	4	0	Yes
240-213	0 - 10V	2	2	
240-214	4 - 20mA	4	0	
240-215	4 - 20mA	2	2	
240-307	0 - 10V	2	2	
240-363	4 - 20mA	4	4	

numatics G3 Series EtherNet/IP™ Technical Manual

One Analog Input per Connector – M12 Female Modules

Module Part No.	Signal Type	Short Circuit Protection	Short Circuit Protection Status Bits	Input Points
240-212	0-10 VDC	YES – Visual	YES (4) – Selectable	4
240-214	4-20 mA			

Input Mapping								
BYTE	Bit 7	Bit 6	Bit 5	Bit 4	Bit 3	Bit 2	Bit 1	Bit 0
X (Required)	Input No. 1	Input No. 1	Input No. 1	Input No. 1	Input No. 1	Input No. 1	Input No. 1	Input No. 1 (LSB)
X+1 (Required)	Input No. 1 (MSB)	Input No. 1	Input No. 1	Input No. 1	Input No. 1	Input No. 1	Input No. 1	Input No. 1
X+2 (Required)	Input No. 2	Input No. 2	Input No. 2	Input No. 2	Input No. 2	Input No. 2	Input No. 2	Input No. 2 (LSB)
X+3 (Required)	Input No. 2 (MSB)	Input No. 2	Input No. 2	Input No. 2	Input No. 2	Input No. 2	Input No. 2	Input No. 2
X+4 (Required)	Input No. 3	Input No. 3	Input No. 3	Input No. 3	Input No. 3	Input No. 3	Input No. 3	Input No. 3 (LSB)
X+5 (Required)	Input No. 3 (MSB)	Input No. 3	Input No. 3	Input No. 3	Input No. 3	Input No. 3	Input No. 3	Input No. 3
X+6 (Required)	Input No. 4	Input No. 4	Input No. 4	Input No. 4	Input No. 4	Input No. 4	Input No. 4	Input No. 4 (LSB)
X+7 (Required)	Input No. 4 (MSB)	Input No. 4	Input No. 4	Input No. 4	Input No. 4	Input No. 4	Input No. 4	Input No. 4
X+8 (Selectable)	Allocated and Reserved	Allocated and Reserved	Allocated and Reserved	Allocated and Reserved	Power Status for Conn. D	Power Status for Conn. C	Power Status for Conn. B	Power Status for Conn. A
X+9 (Selectable)	High Alarm for Conn. D	Low Alarm for Conn. D	High Alarm for Conn. C	Low Alarm for Conn. C	High Alarm for Conn. B	Low Alarm for Conn. B	High Alarm for Conn. A	Low Alarm for Conn. A

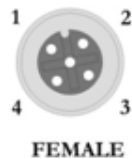

PIN 1= +24VDC (UNSW)
 PIN 2= NOT USED
 PIN 3= 0VDC (UNSW)
 PIN 4= INPUT 1



numatics G3 Series EtherNet/IP™ Technical Manual

One Analog I/O per Connector – M12 Female Modules

Module Part No.	Signal Type	Short Circuit Protection	Short Circuit Protection Status Bits	Output Points	Input Points
240-213	0-10 VDC	YES – Visual	YES (4) – Selectable	2	2
240-215	4-20 mA				

Output Mapping								
BYTE	Bit 7	Bit 6	Bit 5	Bit 4	Bit 3	Bit 2	Bit 1	Bit 0
X	Output No. 1	Output No. 1	Output No. 1	Output No. 1	Output No. 1	Output No. 1	Output No. 1	Output No. 1 (LSB)
X+1	Output No. 1 (MSB)	Output No. 1	Output No. 1	Output No. 1	Output No. 1	Output No. 1	Output No. 1	Output No. 1
X+2	Output No. 2	Output No. 2	Output No. 2	Output No. 2	Output No. 2	Output No. 2	Output No. 2	Output No. 2 (LSB)
X+3	Output No. 2 (MSB)	Output No. 2	Output No. 2	Output No. 2	Output No. 2	Output No. 2	Output No. 2	Output No. 2
Input Mapping								
BYTE	Bit 7	Bit 6	Bit 5	Bit 4	Bit 3	Bit 2	Bit 1	Bit 0
X	Input No. 1	Input No. 1	Input No. 1	Input No. 1	Input No. 1	Input No. 1	Input No. 1	Input No. 1 (LSB)
X+1	Input No. 1 (MSB)	Input No. 1	Input No. 1	Input No. 1	Input No. 1	Input No. 1	Input No. 1	Input No. 1
X+2	Input No. 2	Input No. 2	Input No. 2	Input No. 2	Input No. 2	Input No. 2	Input No. 2	Input No. 2 (LSB)
X+3	Input No. 2 (MSB)	Input No. 2	Input No. 2	Input No. 2	Input No. 2	Input No. 2	Input No. 2	Input No. 2
X+4 (Selectable)	Allocated and Reserved	Allocated and Reserved	Allocated and Reserved	Allocated and Reserved	Power Status for Conn. D	Power Status for Conn. C	Power Status for Conn. B	Power Status for Conn. A
X+5 (Selectable)	High Alarm for Conn. D	Low Alarm for Conn. D	High Alarm for Conn. C	Low Alarm for Conn. C	High Alarm for Conn. B	Low Alarm for Conn. B	High Alarm for Conn. A	Low Alarm for Conn. A



CONNECTORS C & D

PIN 1= +24VDC (UNSW)
 PIN 2= OUTPUT
 PIN 3= 0VDC (UNSW)
 PIN 4= INPUT

CONNECTORS A & B

PIN 1= +24VDC (UNSW)
 PIN 2= NOT USED
 PIN 3= 0VDC (UNSW)
 PIN 4= INPUT



numatics G3 Series EtherNet/IP™ Technical Manual

One Analog I/O per Connector – M12 Female Modules

Module Part No.	Signal Type	Short Circuit Protection	Short Circuit Protection Status Bits	Output Points	Input Points
240-307	0-10 VDC	YES	YES	2	2

Output Mapping								
BYTE	Bit 7	Bit 6	Bit 5	Bit 4	Bit 3	Bit 2	Bit 1	Bit 0
X	Output No. 1	Output No. 1	Output No. 1	Output No. 1	Output No. 1	Output No. 1	Output No. 1	Output No. 1 (LSB)
X+1	Output No. 1 (MSB)	Output No. 1	Output No. 1	Output No. 1	Output No. 1	Output No. 1	Output No. 1	Output No. 1
X+2	Output No. 2	Output No. 2	Output No. 2	Output No. 2	Output No. 2	Output No. 2	Output No. 2	Output No. 2 (LSB)
X+3	Output No. 2 (MSB)	Output No. 2	Output No. 2	Output No. 2	Output No. 2	Output No. 2	Output No. 2	Output No. 2
Input Mapping								
BYTE	Bit 7	Bit 6	Bit 5	Bit 4	Bit 3	Bit 2	Bit 1	Bit 0
X	Input No. 1	Input No. 1	Input No. 1	Input No. 1	Input No. 1	Input No. 1	Input No. 1	Input No. 1 (LSB)
X+1	Input No. 1 (MSB)	Input No. 1	Input No. 1	Input No. 1	Input No. 1	Input No. 1	Input No. 1	Input No. 1
X+2	Input No. 2	Input No. 2	Input No. 2	Input No. 2	Input No. 2	Input No. 2	Input No. 2	Input No. 2 (LSB)
X+3	Input No. 2 (MSB)	Input No. 2	Input No. 2	Input No. 2	Input No. 2	Input No. 2	Input No. 2	Input No. 2
X+4 (Selectable)	Allocated and Reserved	Allocated and Reserved	Allocated and Reserved	Allocated and Reserved	Power / Short Status for Conn. D	Power / Short Status for Conn. C	Allocated and Reserved	Allocated and Reserved
X+5 (Selectable)	High Alarm for Conn. D	Low Alarm for Conn. D	High Alarm for Conn. C	Low Alarm for Conn. C	High Alarm for Conn. B	Low Alarm for Conn. B	High Alarm for Conn. A	Low Alarm for Conn. A

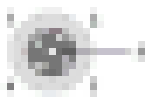

Output Connectors A & B (Female)
 Pin 1 = +24 VDC
 Pin 2 = 0 VDC
 Pin 3 = 0 VDC
 Pin 4 = 0 VDC

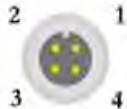

AUXILIARY POWER (Male)
 Pin 1 = +24 VDC (For Conn. C)
 Pin 2 = +24 VDC (For Conn. D)
 Pin 3 = 0 VDC (For Conn. C)
 Pin 4 = 0 VDC (For Conn. D)

Input Connectors A & B (Female)
 Pin 1 = +24 VDC
 Pin 2 = 0 VDC
 Pin 3 = 0 VDC
 Pin 4 = 0 VDC



numatics G3 Series EtherNet/IP™ Technical Manual

9.2 Analog Graphic Display

The G3 Analog I/O modules have an integrated graphic display that may be used to configure the parameters of the modules as well as show diagnostic information. Please see the following pages for detailed information regarding these displays.

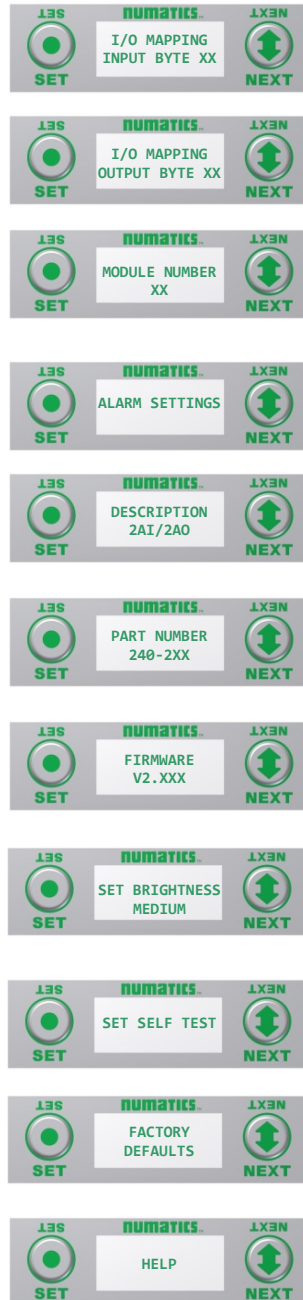

numatics® G3 Series EtherNet/IP™ Technical Manual

Analog Module / I/O Mapping

Displays the starting Input and Output byte address for the module

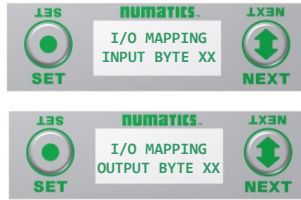

Analog Module / Module Number

Displays the module number; identifying its position in the G3 I/O system.

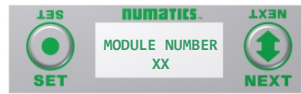

Analog Module / Alarm Settings

Allows the setting of low and high alarms for analog inputs and outputs

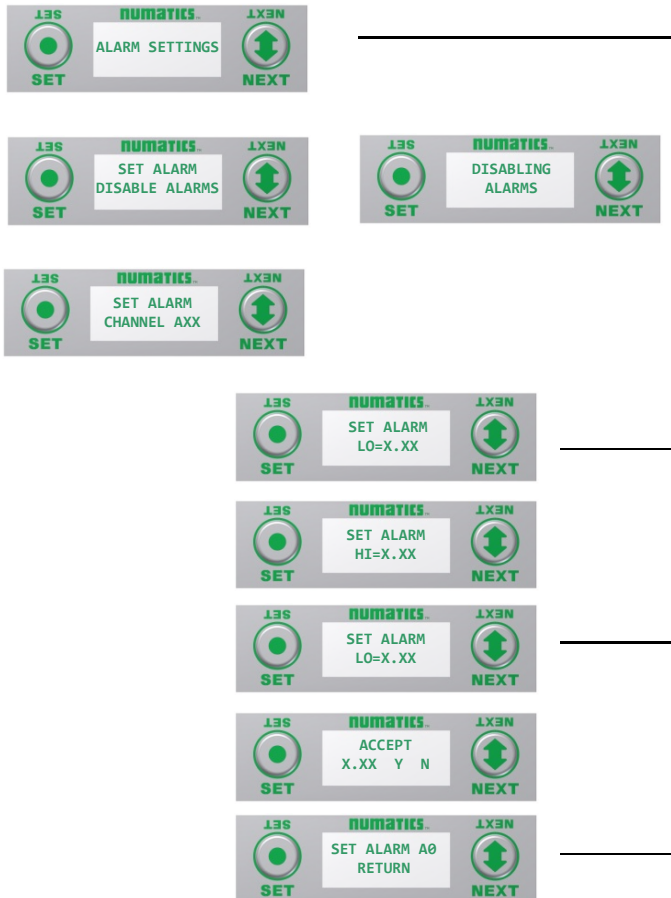

Alarm Settings Steps

1. Press the SET button to enter the Alarm Settings sub-menu.
2. Press the SET button to Disable all alarms (default setting)
*Note- Setting the Minimum value for Low alarm and the Maximum value for High alarm (for a channel) disables the alarm for that channel.
3. Press the NEXT button to scroll to the appropriate analog channel.
4. Press the SET button to set the LO alarm setting
 - a. Push the SET button to access the menu and enter the alarm value
5. Press the NEXT button to SET the HI alarm setting.
 - a. Push the SET button to access the menu and enter the alarm value
 - b. Accept the changes by selecting Y and pushing SET
6. Press the SET button while in the RETURN screen to return to the main menu

NUMATICS G3 Series EtherNet/IP™ Technical Manual

Analog Module / Description

Displays the quantity and type of I/O on the module
Ex. 2 analog Inputs and 2 analog outputs



Analog Module / Part number

Displays the replacement part number of the module

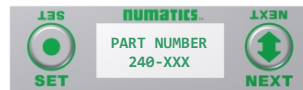

Analog Module / Firmware

Displays the firmware revision level for the module



Analog Module / Brightness

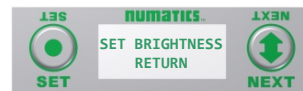

Brightness Settings

1. Press the SET button to enter the SET BRIGHTNESS menu.
2. Press the NEXT button to scroll the choices for the desired brightness of the LCD display for the analog module.
 - a. LOW
 - b. MEDIUM (Factory Default)
 - c. HIGH
 - d. RETURN (this will return you to the main menu)

Press the SET button to confirm your choice. The changes will take effect immediately.

NUMATICS G3 Series EtherNet/IP™ Technical Manual

9.3 Analog Module / Self Test Mode

Self test mode is an internal diagnostic tool that can be enabled on the analog module using the graphic display. This tool allows the user to confirm that all of the outputs on the module are fully functional without needing a network connection or controller. The test will cycle the analog outputs. Starting with Output 0 it will increment the analog signal at 10% intervals; once it has reached 100% it will test the next available output. The self-test will continue to run until it is turned off by pressing the SET button.

To use the Self Test Mode, the user must first set some initial conditions. Follow these steps to initiate the self-test mode.

- 1) **Disconnect Air and Communication from the manifold!**
- 2) Starting at the Home Screen, navigate the menus by selecting the NEXT button until the SELF-TEST menu is shown.
- 3) Select the SET button to access the SELF-TEST menu
- 4) A message will appear: DISCONNECT AIR HOLD SET BUTTON
- 5) Hold the SET button down for approximately 10 seconds to enable the test. The Display will flash the above message while the button is pushed.
- 6) When the display stops flashing, the self-test mode will be running
- 7) Push or hold the NEXT button to cycle through the outputs. Holding the NEXT button will allow the analog outputs to cycle through the 10% intervals automatically. Pushing the NEXT button will allow the outputs to manually step through each 10% interval.
- 8) Releasing the NEXT button will keep the output in its current state.
- 9) The self-test mode can only be disabled by pushing the SET button

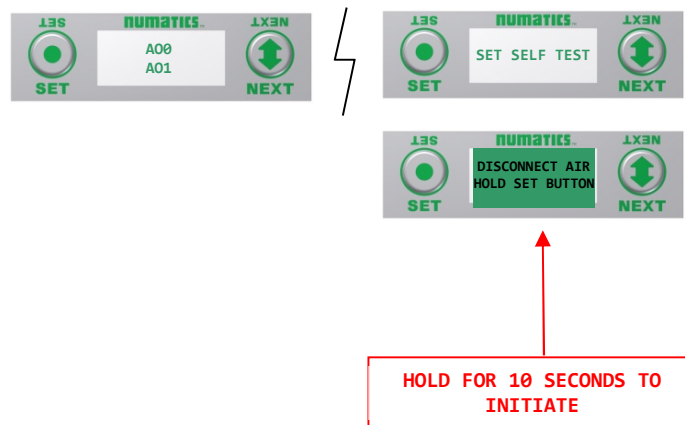

NUMATICS G3 Series EtherNet/IP™ Technical Manual

9.4 Analog Module / Factory Defaults

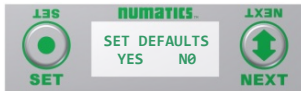

Factory Default Settings

1. Press the SET button to enter the FACTORY DEFAULTS sub-menu.
2. Press the NEXT button to select Yes or No.
 - a. Selecting No will bring you back to the main FACTORY DEFAULTS menu.
 - b. Selecting Yes will cause the module to reset and return all parameters to the factory default conditions.

Press the SET button to confirm your choice.

FACTORY DEFAULT SETTINGS	
Description	Default
Low Alarm Values	0 V / 4 mA
High Alarm Values	10 V / 20 mA
Brightness	Medium

10. Specialty Modules

10.1 RTD Module

The G3 RTD Temperature module is used with Resistive Temperature Detectors (RTDs) and can support up to 4 RTD devices simultaneously. This module supports various RTD types including: Pt100, Pt200, Pt500, Pt1000, Ni100 and Ni1000. Standard M12 single key connector types are used; each connector/port supports one RTD device, but four different device types can be used simultaneously. User configuration of parameters include: RTD type, temperature scale (Celsius or Fahrenheit), Hi/Low temperature alarms, and filter times, and can be selected individually for each connector port using the integrated display. The G3 RTD module can be incorporated into any G3 electronic system regardless of the protocol or I/O module position.

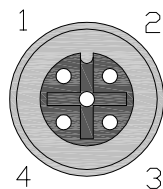

- FEMALE
- PIN 1 = Sensor Current Source (I+)
 - PIN 2 = Sense Voltage (VIN+)
 - PIN 3 = Sensor Current Source (I-)
 - PIN 4 = Sense Voltage (VIN-)
 - PIN 5 = Not Used

NUMATICS G3 Series EtherNet/IP™ Technical Manual

Sensor Wiring Diagrams

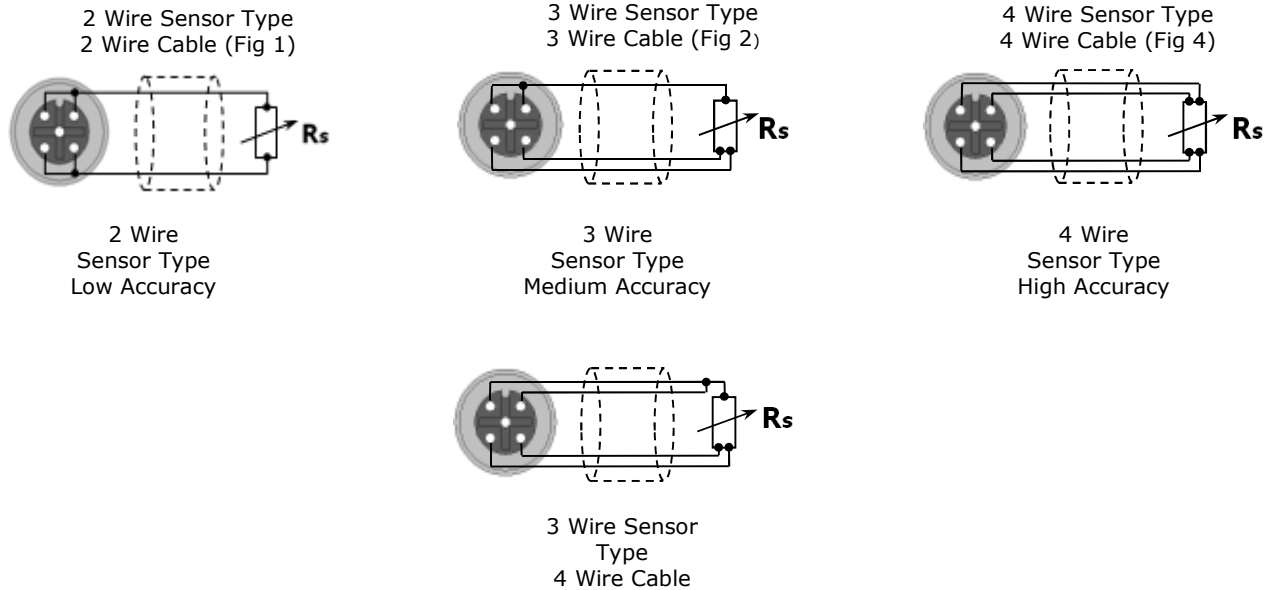

Electrical Data

Voltage	24 VDC Module Supply (Via G3 System Aux. Power Connection)
Input Type	RTD (Resistive Temperature Detector), 4 per Module
Supported Sensor Types	Pt100, Pt200, Pt500, Pt1000, Ni100, Ni1000
Supported Temperature Coefficients	.00385; .00392; . $\Omega/\Omega/^{\circ}\text{C}$
Resolution	15 bits, plus sign.
Data Format	Signed Integer; Two's complement.
Calibration	Factory Calibrated. Field Calibration w/ high tolerance ($\pm 0.005\%$) 100 ohm and 350 ohm resistor.
Input Update (filter) Rate	Adjustable (5-20mS), factory default: 5mS
Accuracy	0.1% of full scale @ 25° C

Mechanical Data

I/O Connector	M12 4 Pin Female (Accepts 5 Pin)
Mass	247g / 8.7oz

Operating Data

Temperature Range	-10° to 115° F (-23° to 46° C)
Humidity	95% relative humidity: non-condensing
Ingress Protection	IP65 (with appropriate assembly and terminations)



- For maximum accuracy on a 3-wire sensor type make identified jumper connections at the sensor end (see Figure 3). Cable resistance, resulting from cable length, affects measuring error; therefore, use cables that are as short as possible.
- For long cable runs and high accuracy use 4 wire sensor types.

numatics G3 Series EtherNet/IP™ Technical Manual

Part Numbers and Mapping

Module Part No.	I/O Type	Alarms	Diagnostics	Input Points
240-311	RTD	Hi/Low Temp for each Channel	Open/Short, Out of Range	4

Input Mapping								
BYTE	Bit 7	Bit 6	Bit 5	Bit 4	Bit 3	Bit 2	Bit 1	Bit 0
X	RTD Channel 0	RTD Channel 0	RTD Channel 0	RTD Channel 0	RTD Channel 0	RTD Channel 0	RTD Channel 0	RTD Channel 0
X+1	Sign Bit Channel 0	RTD Channel 0	RTD Channel 0	RTD Channel 0	RTD Channel 0	RTD Channel 0	RTD Channel 0	RTD Channel 0
X+2	RTD Channel 1	RTD Channel 1	RTD Channel 1	RTD Channel 1	RTD Channel 1	RTD Channel 1	RTD Channel 1	RTD Channel 1
X+3	Sign Bit Channel 1	RTD Channel 1	RTD Channel 1	RTD Channel 1	RTD Channel 1	RTD Channel 1	RTD Channel 1	RTD Channel 1
X+4	RTD Channel 2	RTD Channel 2	RTD Channel 2	RTD Channel 2	RTD Channel 2	RTD Channel 2	RTD Channel 2	RTD Channel 2
X+5	Sign Bit Channel 2	RTD Channel 2	RTD Channel 2	RTD Channel 2	RTD Channel 2	RTD Channel 2	RTD Channel 2	RTD Channel 2
X+6	RTD Channel 3	RTD Channel 3	RTD Channel 3	RTD Channel 3	RTD Channel 3	RTD Channel 3	RTD Channel 3	RTD Channel 3
X+7	Sign Bit Channel 3	RTD Channel 3	RTD Channel 3	RTD Channel 3	RTD Channel 3	RTD Channel 3	RTD Channel 3	RTD Channel 3
X+8 (Selectable)	Channel 3 Out of Range	Channel 2 Out of Range	Channel 1 Out of Range	Channel 0 Out of Range	Channel 3 Open/Short	Channel 2 Open/Short	Channel 1 Open/Short	Channel 0 Open/Short
X+9 (Selectable)	Channel 3 High Alarm	Channel 3 Low Alarm	Channel 2 High Alarm	Channel 2 Low Alarm	Channel 1 High Alarm	Channel 1 Low Alarm	Channel 0 High Alarm	Channel 0 Low Alarm

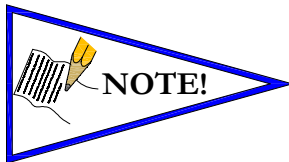

Data is represented by Two's Complement, in tenths of a degree.

NUMATICS® G3 Series EtherNet/IP™ Technical Manual

RTD Module Graphic display

RTD Module / Temperature Monitoring

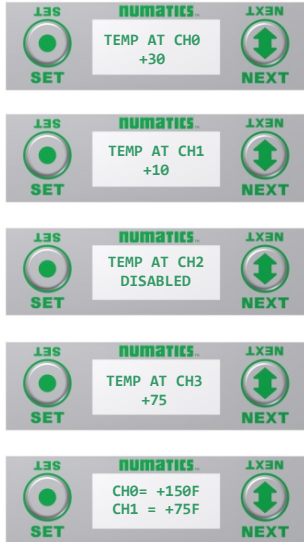

- 1) Press the NEXT button to scroll through the Temperature Monitoring display options.

Pressing the SET button while in one of the Temperature Monitoring displays, will return the display back to the home screen.

If "DISABLED" is the temperature identified at any channel, advance the display to Sensor Type Select, to choose a sensor/Enable the channel, or press the "SET" button to jump directly to the selection display.

Unused channels should be left "DISABLED".

NUMATICS G3 Series EtherNet/IP™ Technical Manual

RTD Module / Sensor Type Select (Channel Enable)

Allows the sensor type for each channel to be selected, and, enable the channel selected

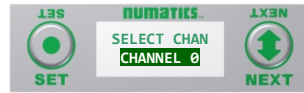

A) Press the SET button to enter the Sensor Type Select sub menu.

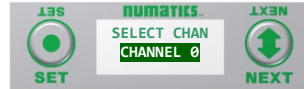

B) Press the NEXT button to scroll through the channels.

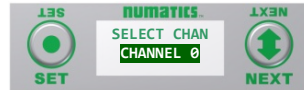

C) Press the SET button to select the desired channel. If "DISABLED" is the first selection, the channel is not enabled. Select a sensor type to enable the channel.

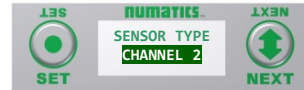

D) Press the NEXT button to scroll through the available sensor types.

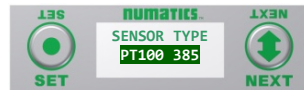

E) Press the SET button to select the desired sensor type.

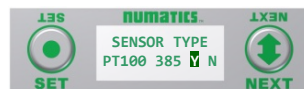

F) Press the SET button to load the selected sensor type.

NUMATICS G3 Series EtherNet/IP™ Technical Manual

RTD Module / Temperature Scale

Allows the temperature scale for each channel to be set to Celsius or Fahrenheit.

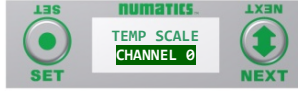
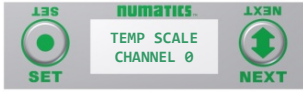

A) Press the SET button to enter the Temp Scale sub menu.



B) Press the NEXT button to scroll through the channels.



C) Press the SET button to choose the desired channel.

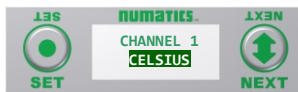

D) Press the NEXT button to choose the desired scale.

E) Press the SET button to load the selection.

numatics G3 Series EtherNet/IP™ Technical Manual

RTD Module / Alarm Settings

Allows the Low and High alarms of each RTD Input channel to be set. This parameter generates a visual and logical (bit) when set value is achieved.

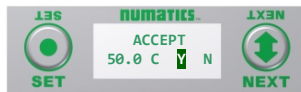
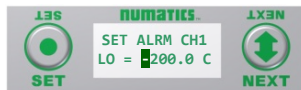

- A) Press the SET button to enter the Alarm Settings sub-menu.
- B) Press the NEXT button to scroll through the RTD Input channels.
- C) Press the SET button to enter the alarm setting for the selected Input channel.
- D) Press the NEXT button to select the Lo or High setting for the selected channel.
- E) Press the SET button to select the change process for the chosen alarm. The first digit/sign will be highlighted.
- F) Press the NEXT button to choose the value, or the SET button to select and move to the next digit.
- G) Press the NEXT button to choose "Y" or "N" Select. Then press the SET Button to Accept.



- When alarm values are set to maximum/minimum values, the alarm function is disabled.
- Factory default settings for all alarms are disabled.

NUMATICS® G3 Series EtherNet/IP™ Technical Manual

RTD Module / Advanced Setting

Allows the Update Filters for each channel to be set.



A) Press the SET button to enter the Advance Settings sub-menu.

B) Press the NEXT button to choose the option; Update Filters or Calibrate RTD.

Update Filters



C) Press the SET button to choose the Update Filter setting.

D) Press the NEXT button to scroll through the filter times.



E) Press the SET button to select the desired Update Filter time.

numatics G3 Series EtherNet/IP™ Technical Manual

RTD Module / I/O Mapping Input Byte

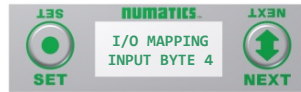

RTD Module / Module Number (Position)

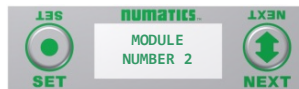

RTD Module / Module Description



RTD Module / Part Number



RTD Module / Firmware Revision



NUMATICS G3 Series EtherNet/IP™ Technical Manual

RTD Module / Set Display Brightness

Allows the Brightness of the display to be changed



- A) press the SET button to enter the Set Brightness sub menu.
- B) Press the NEXT button to scroll through the brightness options
- C) Press the SET button to load the selection.

RTD Module / Flip Display

Allows the Display to be flipped 180 degrees.



- A) press the SET button to enter the Flip Display sub menu.
- B) Press the NEXT button to choose the orientation.
- C) Press the SET button to load the selection.

numatics G3 Series EtherNet/IP™ Technical Manual

RTD Module / Factory Defaults

Set all parameter settings to default values.

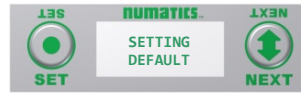
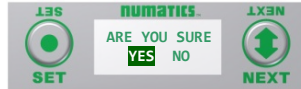
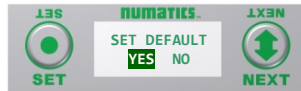

- A) Press the SET button to enter the Factory Defaults sub menu.
- B) Press the NEXT button to choose Yes or No.
- C) Press the SET button to confirm.
- D) Press the SET button again.

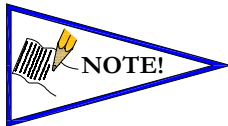

Factory Default Settings	
Alarm - High & Low	Disabled (Set to Min/Max for each chosen sensor)
Input Update Filter	5 mS
Sensor Type	Pt 100 385
Temp Scale	Celsius
Display Brightness	Medium
Flip Display	Normal

NUMATICS G3 Series EtherNet/IP™ Technical Manual

10.2 Sub-Bus Hub Module

The G3 HUB module allows for branch distribution from the I/O side of the G3 System and can be integrated into the existing G3 Series Sub-Bus configuration. Auto Addressing allows for trouble free set up and configuration. Input, Output, as well as Valve manifolds can be attached to the available four Branches on a HUB module. Each G3 System can support up to two HUB modules, allowing for maximum flexibility. The HUB module is transparent to the I/O side of the G3 and does not reserve one of the potential sixteen positions.

Module Part No.	Module Type	Diagnostics	Input Size / Output Size	Branches
240-326	HUB	Sub-Bus Short Circuit	0 / 0 – See Note	4

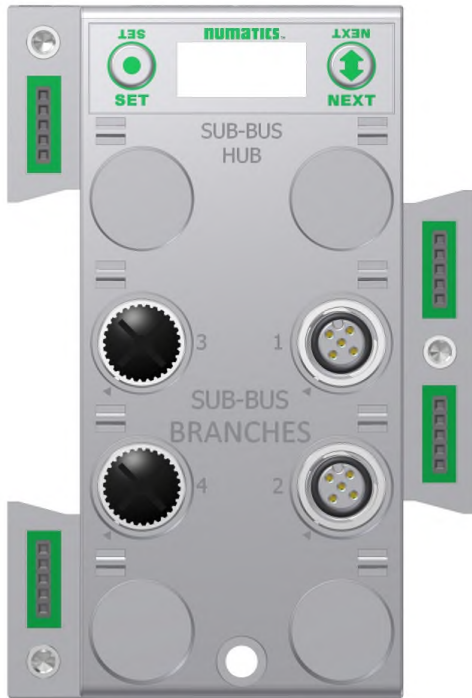

numatics G3 Series EtherNet/IP™ Technical Manual

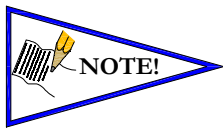
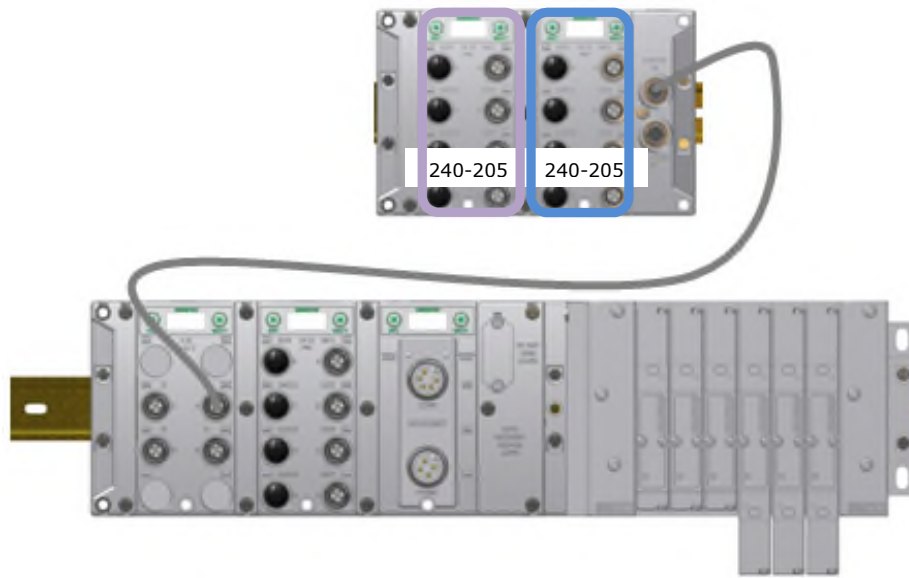

The Sub-bus hub module does not produce mapped diagnostics. The data table in this example represents what is physically attached to the HUB module. This will change as modules are added or removed.

Example I/O Mapping of Attached Modules								
BYTE	Bit 7	Bit 6	Bit 5	Bit 4	Bit 3	Bit 2	Bit 1	Bit 0
X (Required)	Input 7	Input 6	Input 5	Input 4	Input 3	Input 2	Input 1	Input 0
X+1 (Required)	Input 15	Input 14	Input 13	Input 12	Input 11	Input 10	Input 9	Input 8
X+2 (Selectable)	Conn. H SCP Status	Conn. G SCP Status	Conn. F SCP Status	Conn. E SCP Status	Conn. D SCP Status	Conn. C SCP Status	Conn. B SCP Status	Conn. A SCP Status
X+3 (Required)	Input 7	Input 6	Input 5	Input 4	Input 3	Input 2	Input 1	Input 0
X+4 (Required)	Input 15	Input 14	Input 13	Input 12	Input 11	Input 10	Input 9	Input 8
X+5 (Selectable)	Conn. H SCP Status	Conn. G SCP Status	Conn. F SCP Status	Conn. E SCP Status	Conn. D SCP Status	Conn. C SCP Status	Conn. B SCP Status	Conn. A SCP Status

Where X = starting byte

NUMATICS G3 Series EtherNet/IP™ Technical Manual

Hub Module / Identification

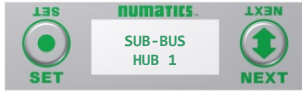

- 1) Identifies HUB module in G3 System.

Hub Module / Description

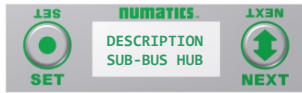

- 2) Identifies Module type.

Hub Module / Advanced Settings



- 3) Allows the user to set/configure module parameters.

Brightness



Press the SET button to advance to the first parameter/setting.

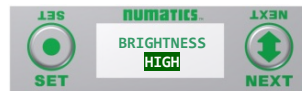

- A) Press the SET button to enter the Set Brightness sub-menu and highlight the selection.
- B) Press the NEXT button to select the desired Brightness selection, (Low, Medium, High).



- C) Press the SET button to select the desired Brightness level.

Screen Jumps to Next Parameter/Selection

Flip Display



- D) Press the SET button to enter the Flip Display sub-menu and highlight the selection.
- E) Press the NEXT button to select the desired Flip Display selection, (Normal, Flipped).

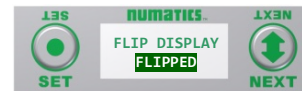

- F) Press the SET button to select the desired display orientation.
- G) Press NEXT to advance to the next parameter selection (Branch Reserve)

numatics G3 Series EtherNet/IP™ Technical Manual

Branch Reserve I/O

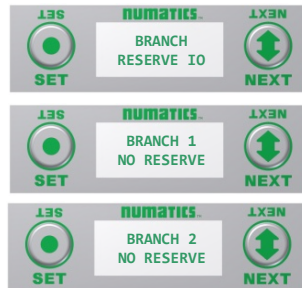

- A) Press the SET button to enter the Branch Reserve IO sub-menu.
- B) Press the NEXT button to select the desired Branch to reserve I/O bytes.

I/O data bytes can be reserved on each branch for future expansion within the G3 system. Space is reserved in Byte levels, and populates Input, Output, and Status depending on the protocol and configuration chosen (e.g. EtherNet/IP™).

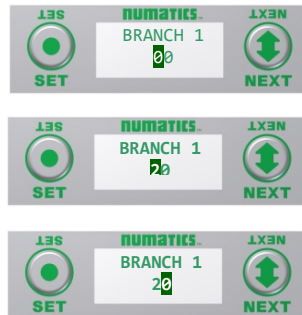

- C) Press the SET button to enter the chosen Branch/Byte Selection screen.
- D) Press the NEXT button to select the desired Tens value of reserved bytes.
- E) Press the SET button to set the desired Tens value.
- F) The screen will advance to the Ones selection
- G) Press the NEXT button to select the desired Ones value for reserved bytes.
- H) Press the SET button to set the desired Ones value.

Once the desired byte size is chosen for the selected branch, the screen will jump to the next branch. The same process is performed for the remaining branches, if desired. Press the NEXT button to skip over branches that do not require reserving I/O.



- *The maximum reserve is 64 bytes per branch.*

NUMATICS G3 Series EtherNet/IP™ Technical Manual

Factory Defaults



4) Allows all parameter settings to be set back to default values.



- A) Press the SET button to enter the Factory Defaults sub menu.
- B) Press the NEXT button to choose Yes or No.
- C) Press the SET button to confirm.

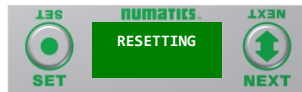

- D) Press the SET button again.

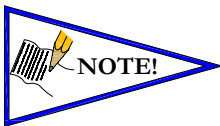

<i>Factory Default Settings</i>	
Brightness	Medium
Flip Display	Normal
Reserve I/O	No Reserve (all Branches)

NUMATICS G3 Series EtherNet/IP™ Technical Manual

Diagnostics



Part Number



Firmware Rev.



Branch Connections

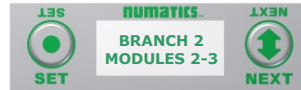

5) Allows the user to reference Part No., Firmware Rev., and Branch Connections.

A) Press the NEXT button to enter the Diagnostics sub-menu.

The Part Number screen is displayed (reference only).

B) Press the NEXT button to advance to the Firmware revision screen (reference only).

C) Press the NEXT button to advance to the Branch Connections screen.

D) Press the SET button to enter the Branch Connections sub-menu.

E) Press the NEXT button to advance through the Branches.

Each Branch screen indicates identifies the module numbers that are currently connected to that Branch.

HELP



6) Directs the user to the ASCO website.

A) Press the SET button for website address.

numatics G3 Series EtherNet/IP™ Technical Manual

Error/Event Messages

The following are error messages that are displayed when specific faults/events occur during operation:

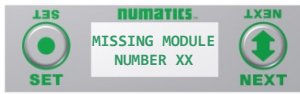

Displayed when a Sub-Bus module that had been previously installed becomes absent from the configuration



Displayed when a Sub-Bus power short circuit condition is detected

Connector Pin Out

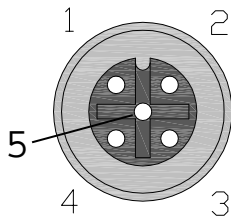

FEMALE

- PIN 1 = Shield
- PIN 2 = V+
- PIN 3 = V-
- PIN 4 = CAN_H
- PIN 5 = CAN_L

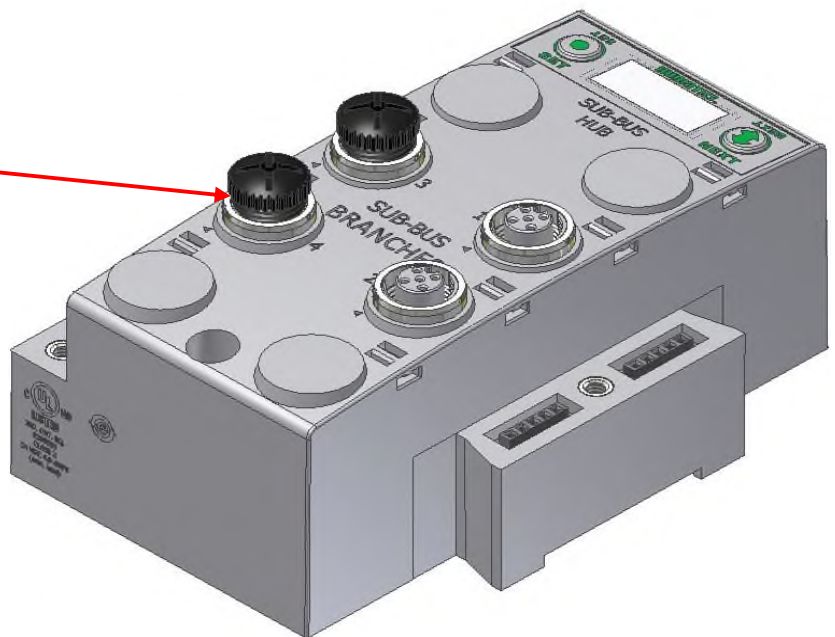

- Length of molded or field wired Sub-Bus Branch cables should not exceed the maximum length of 30 meters per Sub-Bus Branch communication link.
- The molded cable assemblies and bulk cable are the only approved cables for the G3 Sub-Bus and Branch Link. Please refer to the G3 Electronics catalog (LT-G3Catalog), for Sub-Bus cable and connectors options. See Technical Document TDG3SBWD1-0EN for proper installation and wiring of field wireable connectors.

numatics G3 Series EtherNet/IP™ Technical Manual

HUB Integration - Example

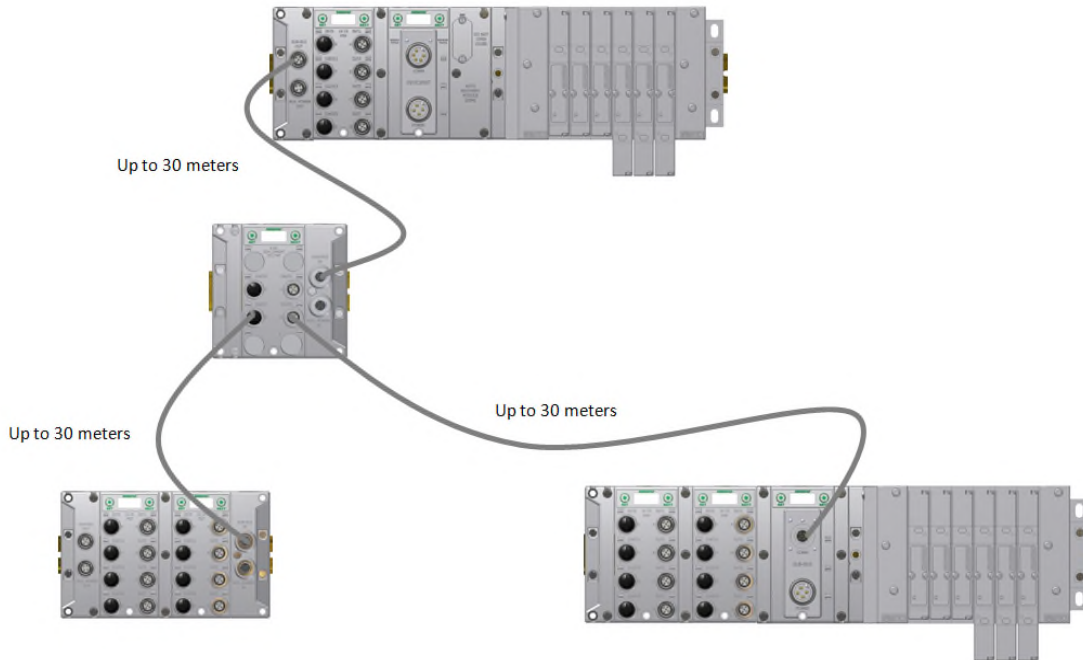

numatics
EMERSON
Industrial Automation

[Home](#) | [Node Configuration](#) | [Node Password](#) | [Diagnostics](#) | [RSLogix 5000 Config](#) | [Quick Start Manual](#) | [Download EDS](#) | [Numatics.com](#)

Module	Part No.	Description	Details	Activity
Node	240-325	EtherNet/IP DLR/QC Communications Module	<input type="checkbox"/> Show Details	<input type="button" value="Close all Details"/> ✔
ARM	240-182	Auto Recovery Module	<input type="checkbox"/> Show Details	<input type="button" value="Close all Details"/> ✔
No. 1	240-205	16 Inputs PNP Digital M12 x 8	<input type="checkbox"/> Show Details	<input type="button" value="Close all Details"/> ✔
Hub 1	240-326	Sub-Bus Hub Module	<input checked="" type="checkbox"/> Show Details	<input type="button" value="Close all Details"/> ✔
		Firmware Revision:	2 070	
			Branch 1	Branch 2
		I/O Reserved (bytes):	-	-
		Unused Reserved Input (bytes):	-	-
		Unused Reserved Diagnostic (Status) Inputs (bytes):	-	-
		Unused Reserved Output (bytes):	-	-
		Module No's. on branch:	-	2, 3, 4
			Branch 3	Branch 4
			-	5, 6
→ Branch 2, Mod. No. 2	240-241	Sub-Bus Valve Driver	<input type="checkbox"/> Show Details	<input type="button" value="Close all Details"/> ✔
→ Branch 2, Mod. No. 3	240-205	16 Inputs PNP Digital M12 x 8	<input type="checkbox"/> Show Details	<input type="button" value="Close all Details"/> ✔
→ Branch 2, Mod. No. 4	240-205	16 Inputs PNP Digital M12 x 8	<input type="checkbox"/> Show Details	<input type="button" value="Close all Details"/> ✔
→ Branch 4, Mod. No. 5	240-205	16 Inputs PNP Digital M12 x 8	<input type="checkbox"/> Show Details	<input type="button" value="Close all Details"/> ✔
→ Branch 4, Mod. No. 6	240-205	16 Inputs PNP Digital M12 x 8	<input type="checkbox"/> Show Details	<input type="button" value="Close all Details"/> ✔
			<input type="checkbox"/> Show Error/Event Log	

11. I/O Module Wiring Diagrams

11.1 NPN/PNP Definitions

NPN Descriptions

- Sinking
- Switching Negative
- Positive Common

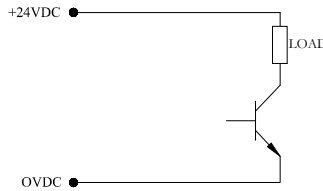

PNP Descriptions

- Sourcing
- Switching Positive
- Negative Common

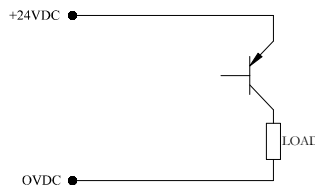

NPN (Sinking) Input Connection

Electric Sensor Type

Mechanical Sensor Type

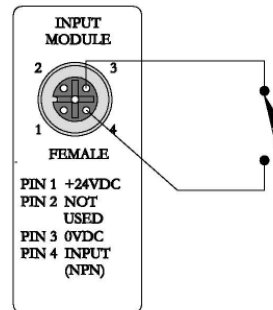
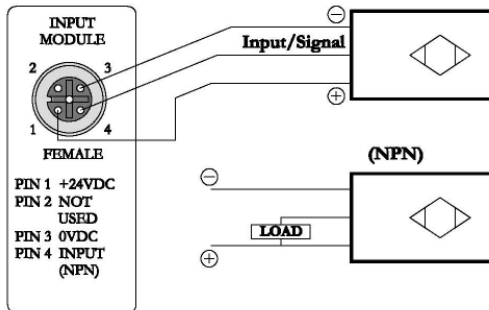

PNP (Sourcing) Input Connection

Electric Sensor Type

Mechanical Sensor Type

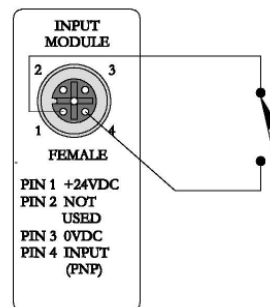
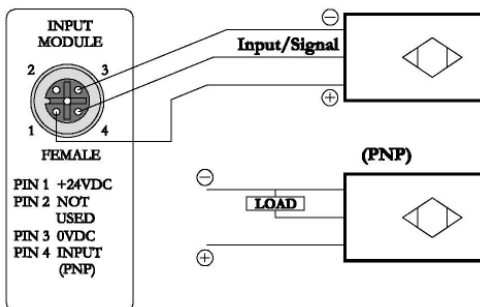

NUMATICS G3 Series EtherNet/IP™ Technical Manual

I/O Module Wiring Diagrams Continued

PNP (Sourcing) Output Connection

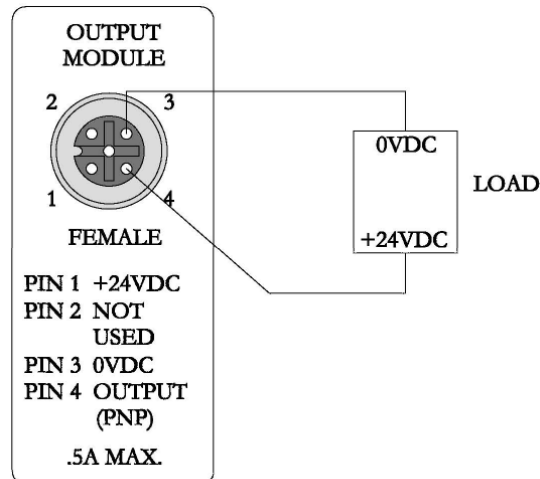

12. EtherNet/IP™ G3 Web Server

12.1 Integrated Web Page Configuration

The ASCO Numatics G3-EtherNet/IP™ node utilizes an integrated web server for user access to configuration parameters and diagnostic features. The "G3 Webpage" can be accessed via any standard web browser program. The following steps describe how to connect to a G3 series EtherNet/IP™ to access the integrated webpage using Windows 7 (see page XXX for Windows 10 instructions).

12.2 Connecting to a G3 Series EtherNet/IP™ Node (Windows 7)

This section will discuss how to connect a computer to a G3 Series EtherNet/IP™ node. There are multiple ways to complete this task, so only two will be discussed. All computer commands are shown in Windows 7.

1. Connect a 24VDC power supply to the valve manifold. The connector pin-out can be found on the side of the EtherNet/IP™ node or on page 20 of this document. (Note: 24VDC only needs to be applied to the "+24VDC (NODE & INPUTS)" pin to power the node.)
2. Connect an Ethernet cable directly from the manifold to the computer -OR- Connect an Ethernet cable from the manifold to a router, hub, or switch. Connect a second Ethernet cable from the computer to the router, hub, or switch. (Network lights should appear on the router, hub, or switch if the correct cables are used).
3. Turn on the computer. Also, make sure the manifold and the router, hub, or switch has power.
4. To communicate with an EtherNet/IP™ manifold the IP address of your computer must be known. To start this process, left click on the "Start" button.
5. Left click on control panel, then left click view network status and tasks



6. The "Network and Sharing Center" window will open. Double click on "Change adapter settings".

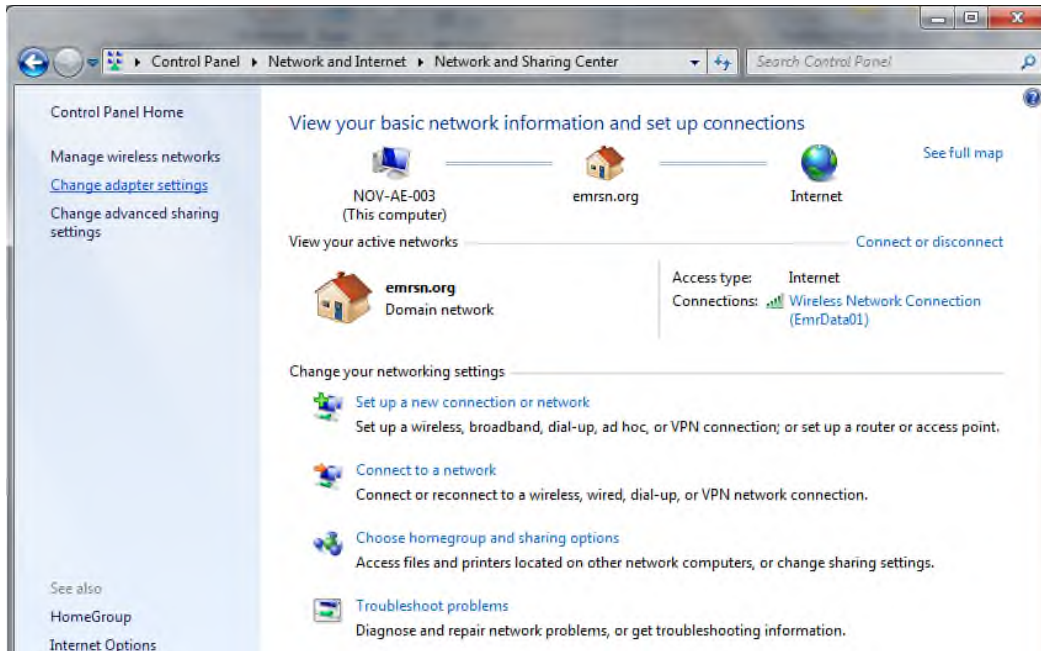

7. The "Network Connections" window opens. Double click the "Local Area Connection"

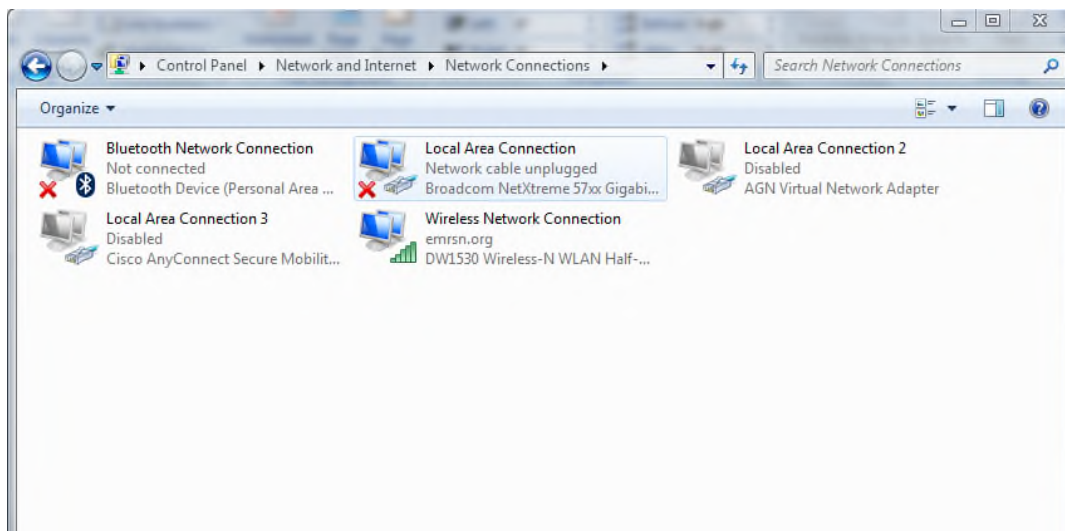

8. Click on "Internet Protocol Version 4 (TCP/IPv4)" the properties window will open

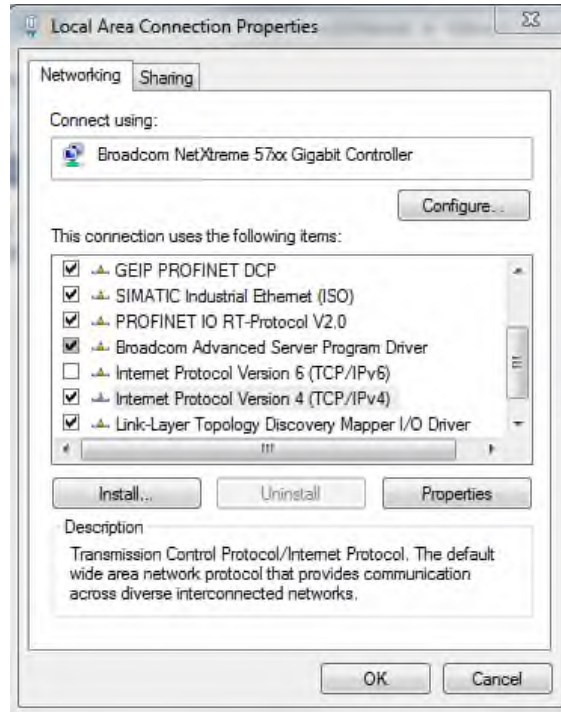

9. Choose the option marked "Use the following IP address" and type in an IP address that has the same first three octets as the address that you will set the manifold to. For the last octet you may choose any number from 0-255, just make sure that it is not the same number as the IP address that the manifold will have. Make sure your subnet mask is set to "255.255.255.0" (this value can be changed, but this value will be used for demonstration purposes).

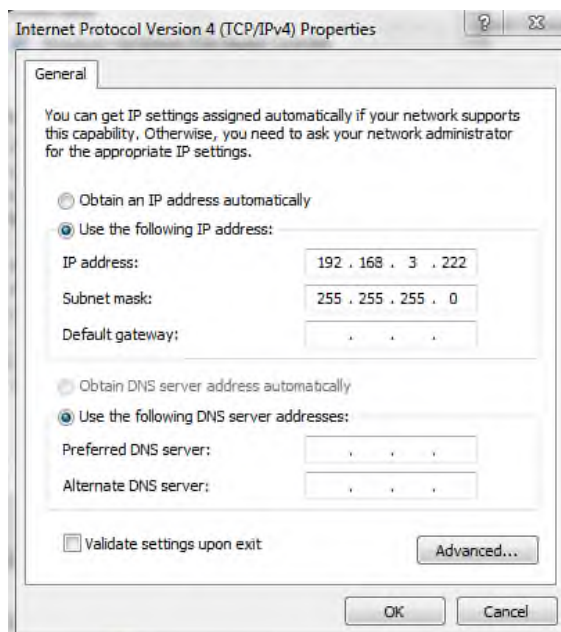

numatics G3 Series EtherNet/IP™ Technical Manual

10. Left click "OK" in the "Internet Protocol (TCP/IP) Properties" and "Local Area Connection" windows for the changes to take effect on the computer. Close out of any open windows.

Once the IP address for the computer is known, you can set the IP address of the ASCO Numatics manifold using one of the methods described on page 30 .

11. Click on "start" then select "All Programs->Accessories->Run".

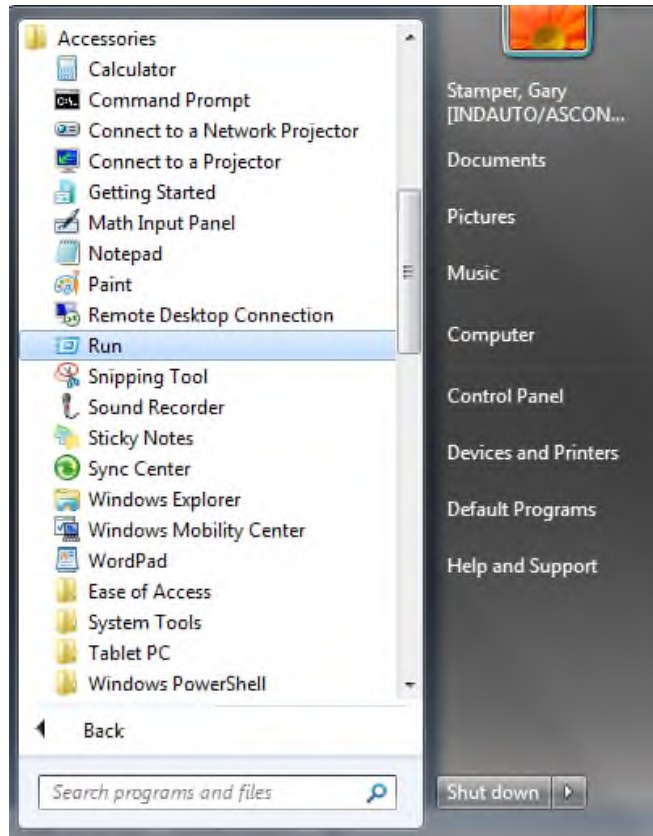

12. Type, "Ping, and then the IP address of the manifold, you can view the address on the graphical display. For example, if the IP address is 192.168.3.120, "ping 192.168.3.120" would be typed. You will get a message stating, "Reply from 192.168.3.120: bytes=32 time<1ms TTL=128", if the manifold responds.

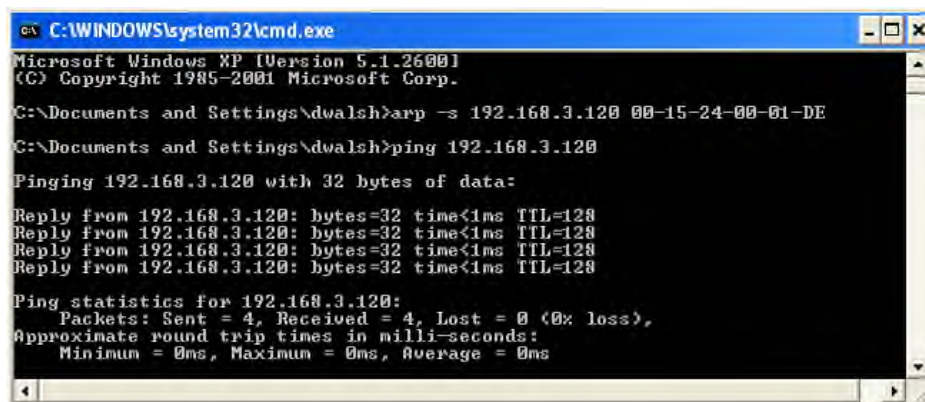

NUMATICS G3 Series EtherNet/IP™ Technical Manual

13. Open a web browser on the computer and type the IP address of the manifold.
Ex. <http://192.168.3.120>. The ASCO Numatics G3 webpage should load after several seconds.



NUMATICS™ G3 Series EtherNet/IP™ Technical Manual

12.3 Connecting to a G3 Series EtherNet/IP™ Node (Windows 10)

This section will discuss how to connect a computer to a G3 Series EtherNet/IP™ node. There are multiple ways to complete this task, so only two will be discussed. All computer commands are shown in Windows 10.

1. Connect a 24VDC power supply to the valve manifold. The connector pin-out can be found on the side of the EtherNet/IP™ node or on page 20 of this document. (Note: 24VDC only needs to be applied to the "+24VDC (NODE & INPUTS)" pin to power the node.)
2. Connect an Ethernet cable directly from the manifold to the computer -OR- Connect an Ethernet cable from the manifold to a router, hub, or switch. Connect a second Ethernet cable from the computer to the router, hub, or switch. (Network lights should appear on the router, hub, or switch if the correct cables are used).
3. Turn on the computer. Also, make sure the manifold and the router, hub, or switch has power.
4. To communicate with an EtherNet/IP™ manifold the IP address of your computer must be known. To start this process, left click on the "Windows" (Start) button.
5. Left click on Settings (gear icon), then on Network & Internet.

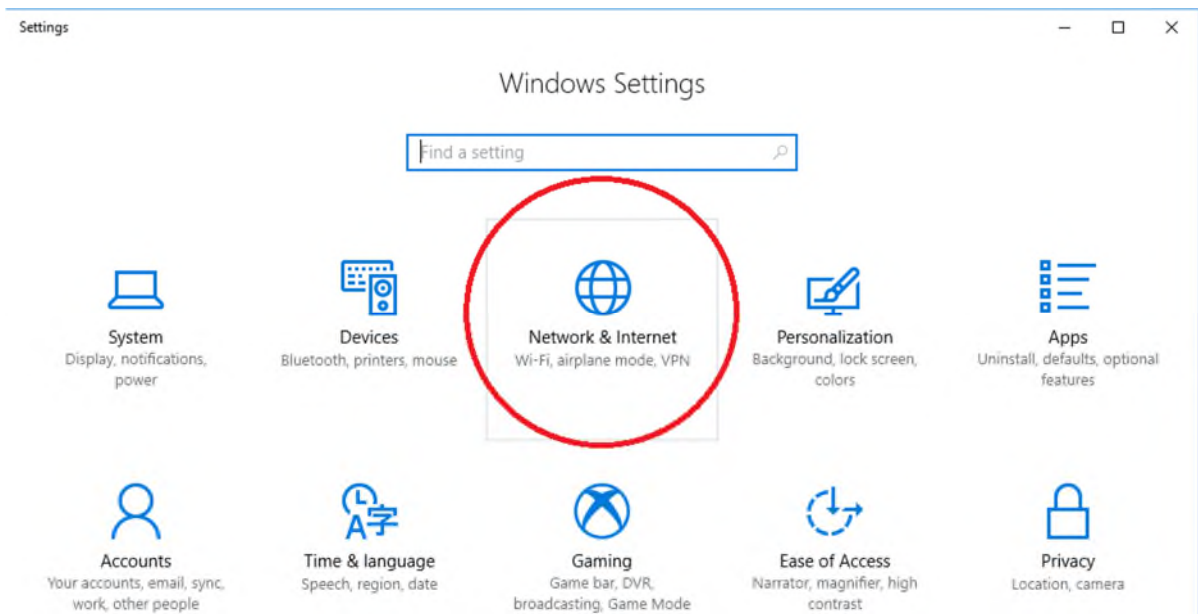

NUMATICS G3 Series EtherNet/IP™ Technical Manual

6. Next, left click on "Ethernet" on the left-hand side of the window, and then "Network and Sharing Center".

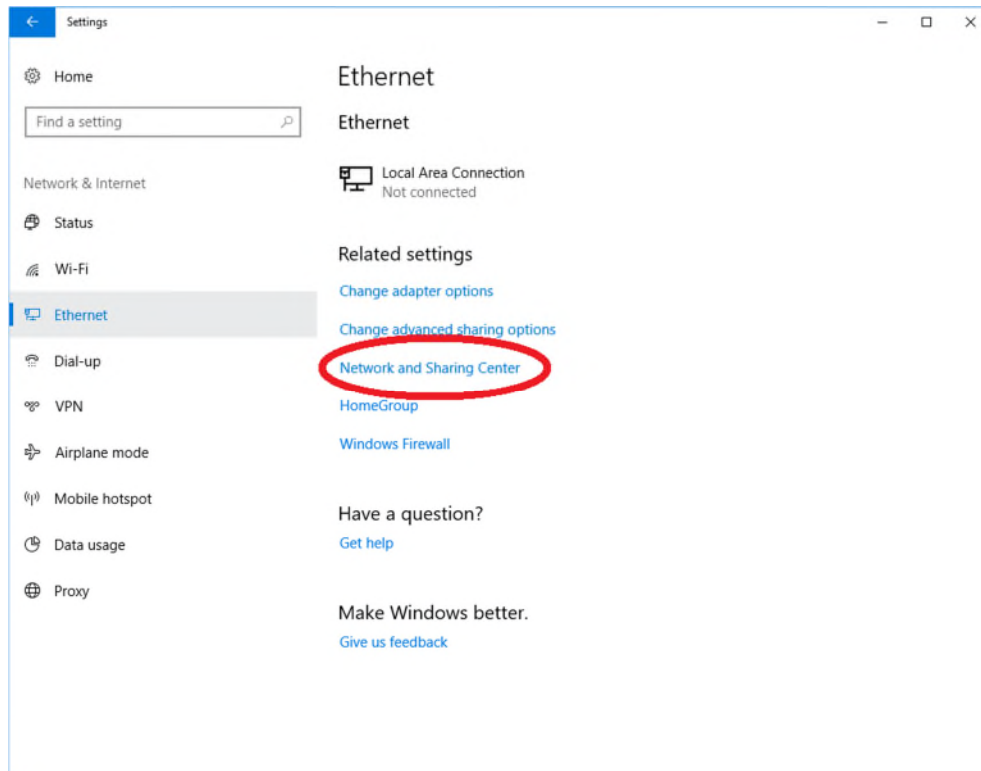

7. The "Network and Sharing Center" window will open. Double click on "Change adapter settings".

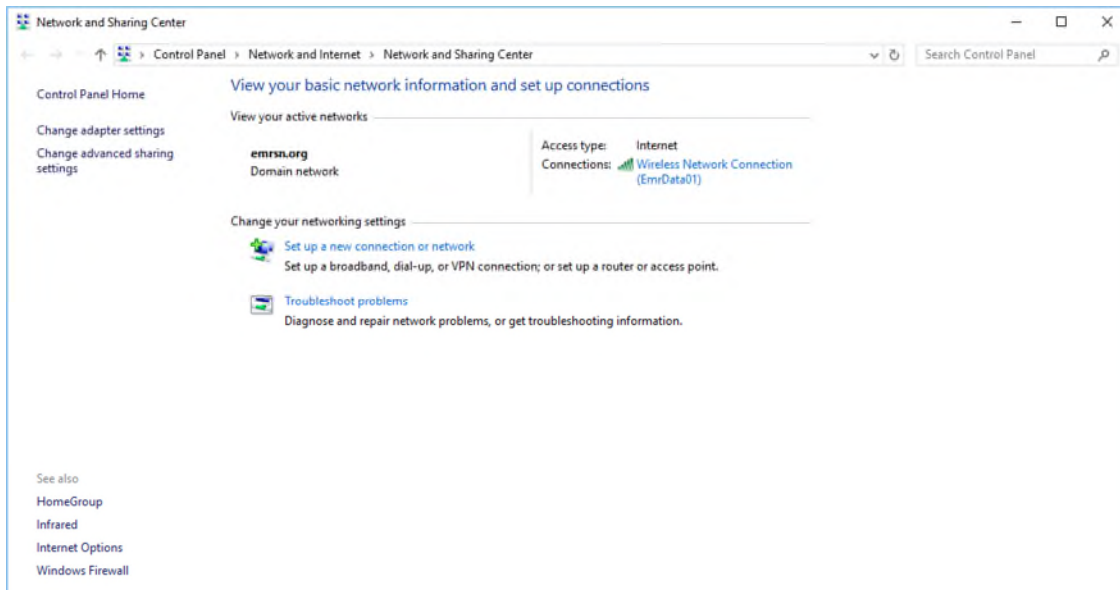

numatics G3 Series EtherNet/IP™ Technical Manual

8. The "Network Connections" window opens. Double click the "Local Area Connection Icon"

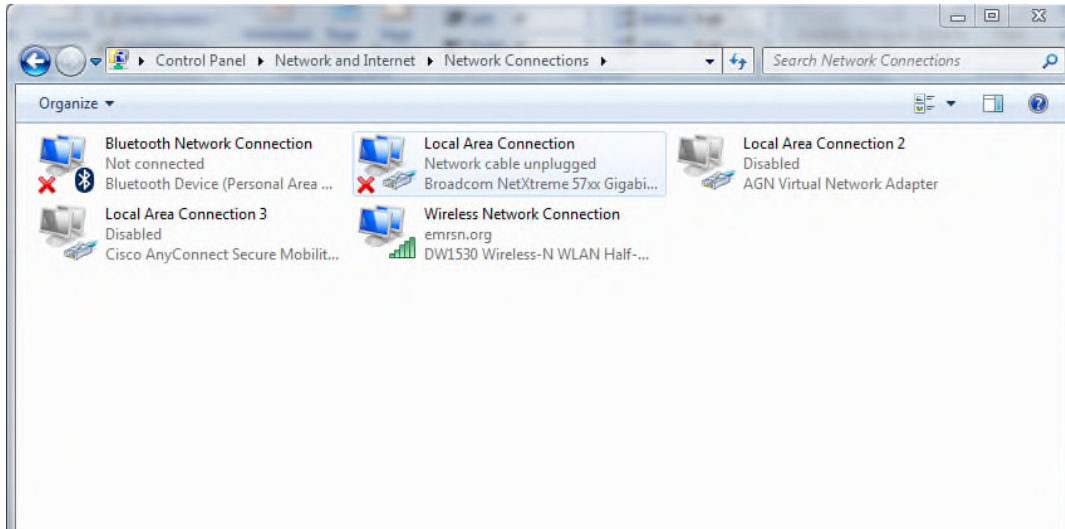

9. Click on "Internet Protocol Version 4 (TCP/IPv4)" the properties window will open

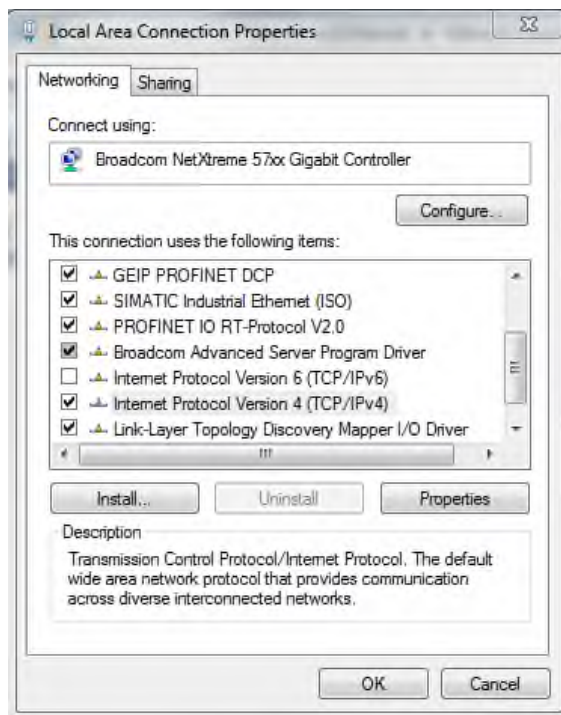

numatics G3 Series EtherNet/IP™ Technical Manual

10. Choose the option marked "Use the following IP address" and type in an IP address that has the same first three octets as the address that you will set the manifold to. For the last octet you may choose any number from 0-255, just make sure that it is not the same number as the IP address that the manifold will have. Make sure your subnet mask is set to "255.255.255.0" (this value can be changed, but this value will be used for demonstration purposes).

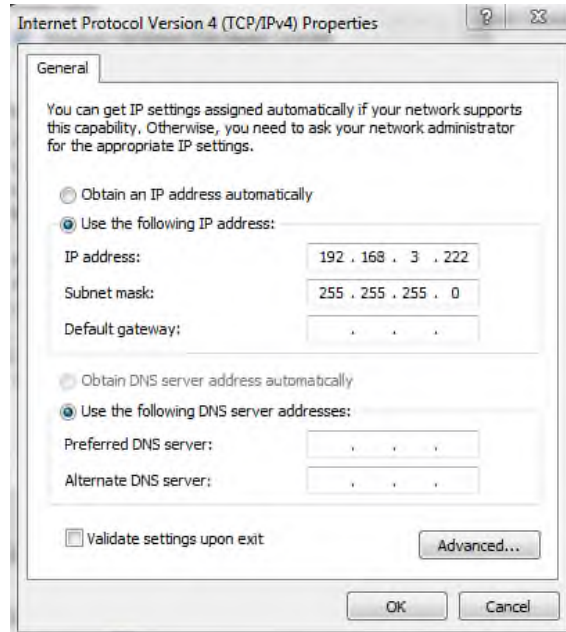

11. Left click "OK" in the "Internet Protocol (TCP/IP) Properties" and "Local Area Connection" windows for the changes to take effect on the computer. Close out of any open windows.

Once the IP address for the computer is known, you can set the IP address of the ASCO Numatics manifold using one of the methods described on page 30 .

12. Click on "start" then select "All Programs->Accessories->Run".

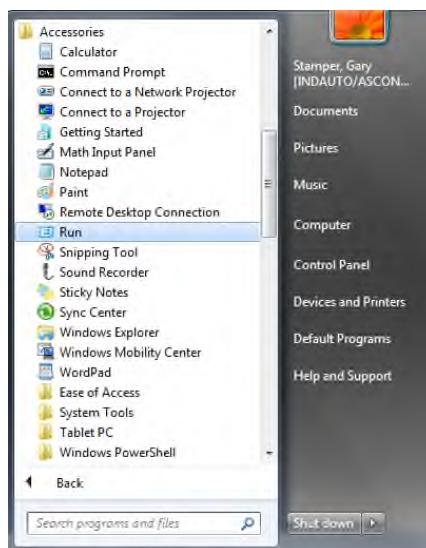

numatics G3 Series EtherNet/IP™ Technical Manual

13. Type, "Ping, and then the IP address of the manifold, you can view the address on the graphical display. For example, if the IP address is 192.168.3.120, "ping 192.168.3.120" would be typed. You will get a message stating, "Reply from 192.168.3.120: bytes=32 time<1ms TTL=128", if the manifold responds.

```
C:\WINDOWS\system32\cmd.exe
Microsoft Windows XP [Version 5.1.2600]
(C) Copyright 1985-2001 Microsoft Corp.

C:\Documents and Settings\dwalsh>arp -s 192.168.3.120 00-15-24-00-01-DE
C:\Documents and Settings\dwalsh>ping 192.168.3.120

Pinging 192.168.3.120 with 32 bytes of data:
Reply from 192.168.3.120: bytes=32 time<1ms TTL=128
Reply from 192.168.3.120: bytes=32 time<1ms TTL=128
Reply from 192.168.3.120: bytes=32 time<1ms TTL=128
Reply from 192.168.3.120: bytes=32 time<1ms TTL=128

Ping statistics for 192.168.3.120:
    Packets: Sent = 4, Received = 4, Lost = 0 (0% loss),
    Approximate round trip times in milli-seconds:
        Minimum = 0ms, Maximum = 0ms, Average = 0ms
```

14. Open a web browser on the computer and type the IP address of the manifold.
Ex. <http://192.168.3.120>. The ASCO Numatics G3 webpage should load after several seconds.



numatics G3 Series EtherNet/IP™ Technical Manual

12.4 EtherNet/IP™ Web Server functionality

This section will discuss the functionality of the built in Ethernet server. Every ASCO Numatics EtherNet/IP™ has this feature. Through this server you can configure the node, force I/O, check diagnostics, etc. Each ASCO Numatics' web page will be explained.

Home

To get to the ASCO Numatics "Home" page, open a web browser. In the URL line, type in the IP address of the manifold and press "Enter". The ASCO Numatics "Home" page will appear. This page shows a picture of the ASCO Numatics EtherNet/IP™ manifold. From this page, the user can navigate the entire built-in web server.



- The 1st three octets of the IP address of the computer **MUST** match the IP address of the node.

numatics G3 Series EtherNet/IP™ Technical Manual

Node Configuration

The "Node Configuration" window can be used to control different parameters within the manifold. These parameters include, "IP Address", "Subnet Mask", "Gateway Address", "SMTP Server", "DHCP/BOOTP enabled", "MAC Address", and "COMM Fault/Idle Mode". "DHCP/BOOTP enabled" is controlled by a single check mark box. "COMM Fault/Idle Mode" has two options that can be chosen: "Hold last Output State" and "Turn OFF All Outputs". *IP address, Subnet Mask, and DHCP/BOOTP enabled* selections can all be configured from this page.



Node Configuration	
(Green selections denote Factory Default settings)	
DHCP:	Disabled
IP Address:	192.168.1.120
Subnet Mask:	255.255.0.0
Gateway IP Address:	
Web Server:	Enabled
COMM Fault / Idle Mode:	Turn OFF All Outputs
Diagnostic Word:	Mapped
I/O (Diagnostics) Status:	Mapped
Node Configuration Parameters:	Unlocked
I/O Configuration:	Unlocked
Save Error / Event Log Entries to Non-Volatile Memory (Disable during machine commissioning / debugging)	Enabled
SNMP	Supported
Display Orientation (Global):	Normal
Display Brightness (Global):	Medium
Comm. Format (I/O Data Padding):	SINT
TCP Timeout (Timeout in minutes):	1
User Defined Links:	<input type="checkbox"/> Show Details

Update Configuration

These parameters will be programmed in the node's non-volatile FLASH memory once "Update Configuration" is clicked, and power to the node is cycled. The "Configuration Successfully Updated" window will appear. The EtherNet/IP™ node will reset in a few seconds, or the user may cycle power to enable the new configuration.

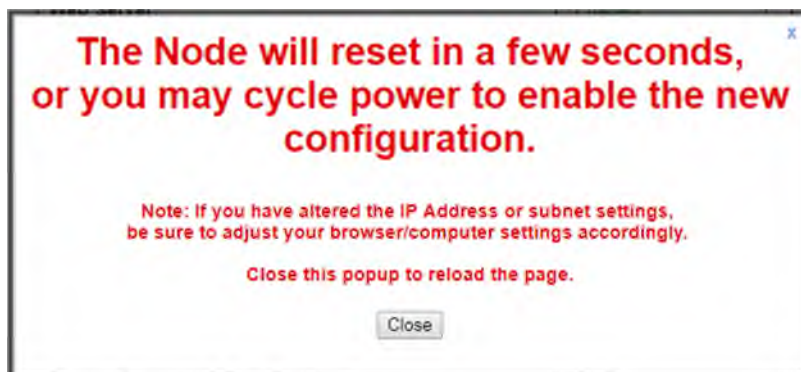

numatics G3 Series EtherNet/IP™ Technical Manual

Password

The "Password" window allows the user to set a password that will prevent unwanted access to the I/O Force and Test functionality. The password comes disabled from the factory. To set the initial password, leave the "Enter Current Password" field blank and type in the new password in the "Enter New Password" field.



Change Password	
Enter Current Password: (up to 20 characters)	<input type="text"/>
Enter New Password: (up to 20 characters)	<input type="text"/>
Repeat New Password:	<input type="text"/>

This page allows password protection of the [Node Configuration](#) page and the I/O Force & Test features of the [Diagnostics](#) page. To disable password protection, leave the "Enter New password" box empty. If you have forgotten a previously set password please contact Numatics Technical support.

Once a Password has been set, the security check screen will appear when accessing the I/O force and test page



- *If the password has been lost or forgotten, go through the process of changing the password. Enter the last 6 digits of the MAC Address in the current password field and then enter the desired password in the new password field.*

numatics G3 Series EtherNet/IP™ Technical Manual

Diagnostics

The “Diagnostics” window allows the user to monitor different values. These values include, “MAC Address”, “Serial Number”, “Firmware Revision”, and “Valve Diagnostic Table”. The “Valve Diagnostic Table” enables the user to check the status of the valve side outputs.



Current Configuration

Module	Part No.	Description	Details	Activity
Node	240-181	EtherNet/IP Communications Module	<input type="checkbox"/> Show Details	✓
Valve Driver	218-828	Valve Driver Output Module	<input type="checkbox"/> Show Details	✓
ARM	240-182	Auto Recovery Module	<input type="checkbox"/> Show Details	✓
No. 1	240-300	8 Outputs High Current PNP Digital M12 x 4	<input type="checkbox"/> Show Details	✓
No. 2	240-209	16 Inputs NPN Digital M12 x 8	<input type="checkbox"/> Show Details	✓
No. 3	240-208	16 Inputs PNP Digital M12 x 8	<input type="checkbox"/> Show Details	✓
No. 4	240-204	16 Inputs NPN Digital Terminal Strip	<input type="checkbox"/> Show Details	✓
No. 5	240-213	2 Inputs / 2 Outputs 0-10V Analog M12 x 4	<input type="checkbox"/> Show Details	✓
No. 6	240-214	4 Inputs 4-20mA Analog M12 x 4	<input type="checkbox"/> Show Details	✓
No. 7	240-206	16 Inputs PNP Digital M12 x 8	<input type="checkbox"/> Show Details	✓
No. 8	240-207	16 Outputs PNP Digital M12 x 8	<input type="checkbox"/> Show Details	✓
No. 9	240-241	Sub-Bus Valve Driver	<input type="checkbox"/> Show Details	✓
No. 10	240-216	2 Inputs / 2 Outputs 4-20 mA Analog M12 x 4	<input type="checkbox"/> Show Details	✓
No. 11	240-208	8 Inputs PNP Digital M12 x 8	<input type="checkbox"/> Show Details	✓
No. 12	240-207	16 Outputs PNP Digital M12 x 8	<input type="checkbox"/> Show Details	✓
No. 13	240-210	8 Inputs NPN Digital M12 x 8	<input type="checkbox"/> Show Details	✓
No. 14	240-206	16 Inputs PNP Digital M12 x 8	<input type="checkbox"/> Show Details	✓
			<input type="checkbox"/> Show Error/Event Log	
			<input type="checkbox"/> Show User Defined Links	

Actual Configuration of modules with part numbers and descriptions including distributed modules

Reports module status:
 ✓ = OK
 ! = Attention
 X = Lost comm.

Selects which module details will be shown, more than 1 can be selected simultaneously.

numatics G3 Series EtherNet/IP™ Technical Manual

Show Details:



Module	Part No.	Description	Details	Activity						
Node	240-181	EtherNet/IP Communications Module	<input checked="" type="checkbox"/> Show Details	<input type="button" value="Close all Details"/>						
Firmware Revision:		1.1 - 40298	<input type="button" value="Firmware Upload"/>							
IP Address:		10.200.75.111								
Subnet Mask:		255.255.255.0								
DHCP/BOOTP:		Enabled								
Active COMM Link Type:		100Mbps/Full Duplex								
MAC Address:		00-15-24-00-0A-42								
Serial Number:		24000A42								
Active Ethernet/IP Connections:		0 (16 max)								
TCP Connections:		1								
Node / Input Power:		24.10V								
Diagnostic Word: Byte 0		I/O Mapping Diagnostic Word (Starting) Byte: 0	7	6	5	4	3	2	1	0
ON = FAULT		Bit 0: Switched Power Status								
		Bit 1: Unswitched Power below 19V								
		Bit 2: Sub-Bus Module Error								
		Bit 3: Sub-Bus Short Circuit								
Diagnostic Word: Byte 1		I/O Mapping Diagnostic Word (Starting) Byte: 1	7	6	5	4	3	2	1	0
		Bits 0-4 (Module No.): I/O Module Number 16								
		Bits 5-7 (Error Code): Lost communication between I/O module and node								

Relevant node information including firmware revision

Graphic of module

Mapping position of "Diagnostic" word.

Diagnostic word information with bit definitions presently shows: Error on Sub-bus, module 16 not communicating.

Valve Driver	Part No.	Description	Details	Activity						
Valve Driver	219-828	Valve Driver Output Module	<input checked="" type="checkbox"/> Show Details	<input type="button" value="Close all Details"/>						
Firmware Revision:		2.04								
Valve Coil		Check/Uncheck box to force/un-force valve coil								
I/O Mapping Output (Starting) Byte: 0			0	1	2	3	4	5	6	7
			8	9	10	11	12	13	14	15
			16	17	18	19	20	21	22	23
			24	25	26	27	28	29	30	31
Output Status (Diagnostics)			0	1	2	3	4	5	6	7
● Shorted Coil			8	9	10	11	12	13	14	15
● Open Coil			16	17	18	19	20	21	22	23
I/O Mapping Diagnostics (Starting) Byte: 2			24	25	26	27	28	29	30	31

Valve coil forcing capability. Can be disabled with password

Shows diagnostic status of whether coils are shorted or open.

numatics G3 Series EtherNet/IP™ Technical Manual

Show Details:

No. 3	240-205	16 Inputs PNP Digital M12 x 8	<input checked="" type="checkbox"/> Show Details	Close all Details					
Firmware Revision		2 017							
	PNP Inputs: I/O Mapping Input (Starting) Byte: 10	<input type="checkbox"/> 0	<input checked="" type="checkbox"/> 1	<input type="checkbox"/> 2	<input type="checkbox"/> 3	<input checked="" type="checkbox"/> 4	<input type="checkbox"/> 5	<input type="checkbox"/> 6	<input type="checkbox"/> 7
		<input type="checkbox"/> 8	<input type="checkbox"/> 9	<input type="checkbox"/> 10	<input type="checkbox"/> 11	<input type="checkbox"/> 12	<input type="checkbox"/> 13	<input type="checkbox"/> 14	<input type="checkbox"/> 15
	Short Circuit on Connector: I/O Mapping Diagnostics (Starting) Byte: 12	<input type="checkbox"/> A	<input type="checkbox"/> B	<input type="checkbox"/> C	<input type="checkbox"/> D	<input checked="" type="checkbox"/> E	<input type="checkbox"/> F	<input type="checkbox"/> G	<input type="checkbox"/> H

Shows input signal status

Shows diagnostic status of source power to sensor, "Connector E shorted"

No. 10	240-215	2 Inputs / 2 Outputs 4 20 mA Analog M12 x 4	<input checked="" type="checkbox"/> Show Details	Close all Details	✓				
Firmware Revision		2 018							
	Analog Outputs: I/O Mapping Output (Starting) Byte: 15	AO0	4.0	(Units mA)	Send Data				
		AO1	4.0	(Units mA)	Send Data				
	Analog Inputs: I/O Mapping Input (Starting) Byte: 41	AI0	4.0 mA						
		AI1	4.0 mA						
	Diagnostic Byte 0: I/O Mapping Diagnostics (Starting) Byte: 45	<input type="checkbox"/>	<input type="checkbox"/>	<input type="checkbox"/>	<input type="checkbox"/>	<input type="checkbox"/> D	<input type="checkbox"/> C	<input type="checkbox"/> B	<input type="checkbox"/> A
	Short Circuit = connection from 24VDC (Pin no. 1) to 0VDC (pin no. 3)	Bit 0:	Short Circuit on connector A						
		Bit 1:	Short Circuit on connector B						
		Bit 2:	Short Circuit on connector C						
		Bit 3:	Short Circuit on connector D						
	Diagnostic Byte 1:	<input type="checkbox"/>	<input type="checkbox"/>	<input type="checkbox"/>	<input type="checkbox"/>	<input type="checkbox"/>	<input type="checkbox"/>	<input type="checkbox"/>	<input type="checkbox"/>
		Bit 0:	Channel 0 alarm low	4.00 mA					
		Bit 1:	Channel 0 alarm high	20.00 mA					
		Bit 2:	Channel 1 alarm low	4.00 mA					
		Bit 3:	Channel 1 alarm high	20.00 mA					
		Bit 4:	Channel 2 alarm low	4.00 mA					
		Bit 5:	Channel 2 alarm high	20.00 mA					
		Bit 6:	Channel 3 alarm low	4.00 mA					
		Bit 7:	Channel 3 alarm high	20.00 mA					

Analog output forcing capability, can be disabled with password

Shows input signal status

numatics G3 Series EtherNet/IP™ Technical Manual

Error / Event Log:

Keeps a running count of 50 events. First in First out (FIFO)

Event No.	Boot Count	Relative Time (HH:MM:SS.SS)	Description	User Comment	Clear Log
1	1	01:10:56.38	Log cleared		Add Comment
2	1	01:11:02.05	Module 3, input connector E short fixed		Add Comment
3	1	01:11:09.68	Module 16 restored		Add Comment
4	1	01:11:21.39	Module 3, input connector E shorted		Add Comment
5	1	01:11:21.39	Module 3, input connector E short fixed		Add Comment
6	1	01:11:21.43	Module 3, input connector E shorted		Add Comment
7	1	01:11:25.18	Module 3, input connector E short fixed		Add Comment
8	1	01:11:40.27	Ethernet link lost		Add Comment
9	1	01:11:45.16	Ethernet link restored		Add Comment
10	2	00:00:00.00	Reboot - build 43238		Add Comment

Allow user to clear log

Allows user to add comments

Reboot events are shown in red

numatics™ G3 Series EtherNet/IP™ Technical Manual

RS Logix 5000 Configuration



Configuration with Studio 5000

When commissioning your EtherNet/IP network, specific values must be entered into the "Module Properties" window for the nodes. The "Connection Parameters" section requires user supplied data for "Input Size", "Output Size", and "Configuration". The table below details all pertinent information and is also dynamic, thus the "Size" data is based on the current/actual configuration of the manifold. It contains the appropriate values for the module's *Connection Parameters* selections.

The sample screenshot is taken from Rockwell Automation's Studio 5000 programming software. It shows where the appropriate values for the IP Address, Assembly Instance, Size, and Configuration must be entered.

Module Properties Based on Actual Configuration

Connection Parameters				
Description	Assembly Instance Value	Comm Format	Size	Notes
Input	100 (Decimal)	Data-SINT (8 bit)	2	The Size values are determined from the number and type of I/O modules that are installed on the manifold (actual physical configuration).
		Data-INT (16 bit)	1	
		Data-DINT (32 bit)	1	
Output	150 (Decimal)	Data-SINT (8 bit)	0	These values are shown in the Size column on the left and are for the specific Comm Format selected. This is a minimum value. Larger values may be specified but may affect overall network throughput.
		Data-INT (16 bit)	0	
		Data-DINT (32 bit)	0	
Configuration	1 (Decimal)	ALL	0	

numatics™ G3 Series EtherNet/IP™ Technical Manual

Download EDS

The "Download EDS" tab provides a link to download either the embedded EDS file in the node or the EDS file available on the ASCO Numatics website <http://www.asco.com/>

ASCO.com

The "ASCO.com" tab is a quick link to ASCO Numatics' website. The computer must have internet access for this tab to be functional.



[Download embedded EDS & ICON files](#)

[Download web based EDS & ICON files](#)

numatics G3 Series EtherNet/IP™ Technical Manual

12.5 IP Address Configuration

The IP address of the ASCO Numatics G3 EtherNet/IP™ node may be configured via several different methods:

- DHCP/BOOTP
- Integrated Web Page Configuration
- Manual Configuration via DIP Switch
- Graphical display

DHCP / BOOTP

The node is shipped from the factory with the DHCP/BOOTP feature enabled. This allows a DHCP server to automatically set the IP address to the node when connected to the network, or a BOOTP server to establish communication to the node and set the IP address. These addressing methods require that the unique MAC ADDRESS of the node is known. The MAC ADDRESS is displayed on the graphical display of the node. It will be different for every node. When DHCP/BOOTP is enabled and a DHCP server is found, the IP address, Subnet mask, and gateway are automatically configured by the DHCP server.

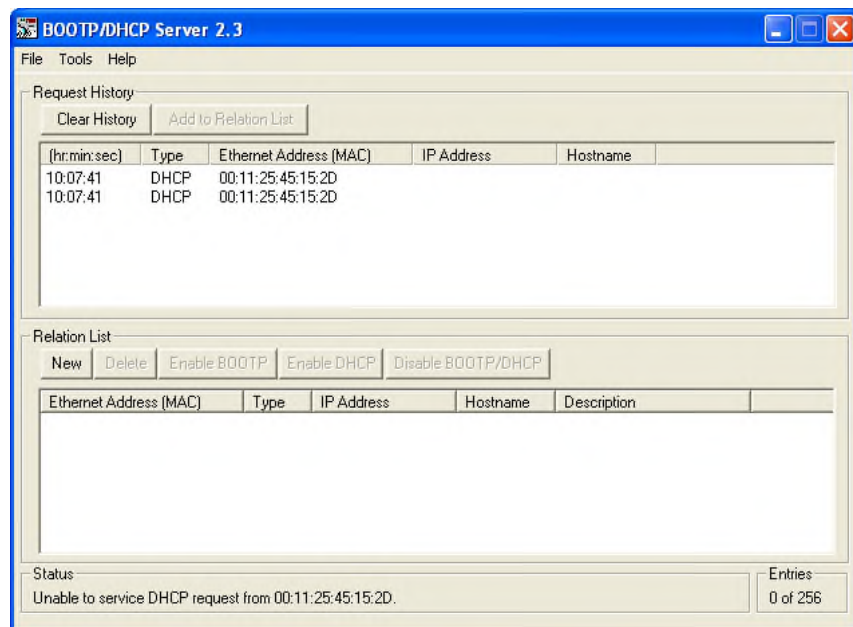

The DHCP/BOOTP setting can be enabled or disabled via the nodes integrated web server or graphical display.

numatics G3 Series EtherNet/IP™ Technical Manual

12.6 Configuration with RSLogix 5000

When commissioning your EtherNet/IP™ network, specific parameters must be entered into the RS Logix 5000 Generic Ethernet Module configuration. These parameters include: "Comm Format", "Assembly Instance", "Input Size", "Output Size", and "Configuration". The "Size" values are determined from the actual physical configuration of the manifold (i.e. how many and which I/O modules are installed on the manifold. The manifold required data size can easily be determined through the RS Logix 5000 Config. tab of the Ethernet IP webpage (see page 11-122). The size values are a minimum value; higher values can be used if future manifold I/O expansion is required. An example of the Generic Ethernet module configuration box is shown below.

New Module

Type: ETHERNET-MODULE Generic Ethernet Module
Vendor: Allen-Bradley
Parent: LocalENB
Name: Numatics_G3_Ethernet_IP
Description:
Comm Format: Data - DINT
Address / Host Name
 IP Address: 192 . 168 . 1 . 120
 Host Name:
Connection Parameters
Assembly Instance: Size:
Input: 100 10 (32-bit)
Output: 150 10 (32-bit)
Configuration: 1 0 (8-bit)
Status Input:
Status Output:
 Open Module Properties
OK Cancel Help

NUMATICS G3 Series EtherNet/IP™ Technical Manual

Generic Ethernet Module Parameters

Comm. Format

The "Comm Format" determines the format of the data exchanged with the G3 EtherNet/IP™ node.

<i>Description</i>	<i>Data</i>	<i>Description</i>
Comm Format	Data - DINT	Double Integer - 32 Bit
	Data - INT	Integer - 16 Bit
	Data - SINT	Single Integer - 8 Bit

Assembly Instance Values

The following Assembly Instance parameters must be used with the G3 EtherNet/IP™ module.

<i>Description</i>	<i>Assembly Instance Values</i>	<i>Size (depends on data format)</i>
Input	100 (Decimal)	Total input value from the physical manifold configuration. This is a minimum value. Larger values may be specified for future expansion purposes.
Output	150 (Decimal)	Total output value from the physical manifold configuration. This is a minimum value. Larger values may be specified for future expansion purposes.
Configuration	1 (Decimal)	0

NUMATICS[®] G3 Series EtherNet/IP™ Technical Manual

12.7 User Configurable Device Parameters

The ASCO Numatics G3 EtherNet/IP™ node allows the user to set many user options which define how the manifold behaves in certain instances. The following is a description of these device parameters.

<i>Name</i>	<i>Description</i>	<i>Display</i>	<i>Web Server</i>
IP Address	Node address	✓	✓
DHCP Boot-P	Enables / Disables DHCP/Boot-P functionality	✓	✓
Web Server	Web Server Enabled	✓	✓
Output Idle Action	Determines whether to use idle value attribute or hold last state	✓	✓
Output Fault Action	Determines whether to use idle value attribute or hold last state	✓	✓

12.8 Communication Fault/Idle Mode Parameter

This parameter is used to describe characteristics or behaviors of output points (bits). The parameter shown below is used to determine what state the outputs will have, during an "Idle" event and a "Fault" event. The Communication Fault/Idle Mode parameter will allow control of all output points on the manifold.

The user, through web page or graphic display settings, can determine how the outputs behave when a communication fault or idle actions occurs. These settings are non-volatile and thus will not change upon loss of power.

The two behavior options are:

1. Hold Last State
2. Turn Off All Outputs

Communication Fault / Idle Mode Sequence

The Communication Fault/Idle Mode parameter determines the output state if the device encounters a communication fault and/or idle action. A Communication Fault is defined as an inability for the master node to communicate with a slave node on a network. Idle Mode is a condition when the processor is in program mode.

The process for determining the output state during a Communication Fault/Idle Mode is as follows:

1. The device receives a Communication Fault/Idle Mode event.
2. The device determines what action to take based on the Communication Fault/Idle Mode attribute setting.
3. If the attribute is set to turn off all outputs, all of the outputs will turn off (Factory Default Setting).
4. If the attribute is set to hold last state, all of the outputs will hold their last state.

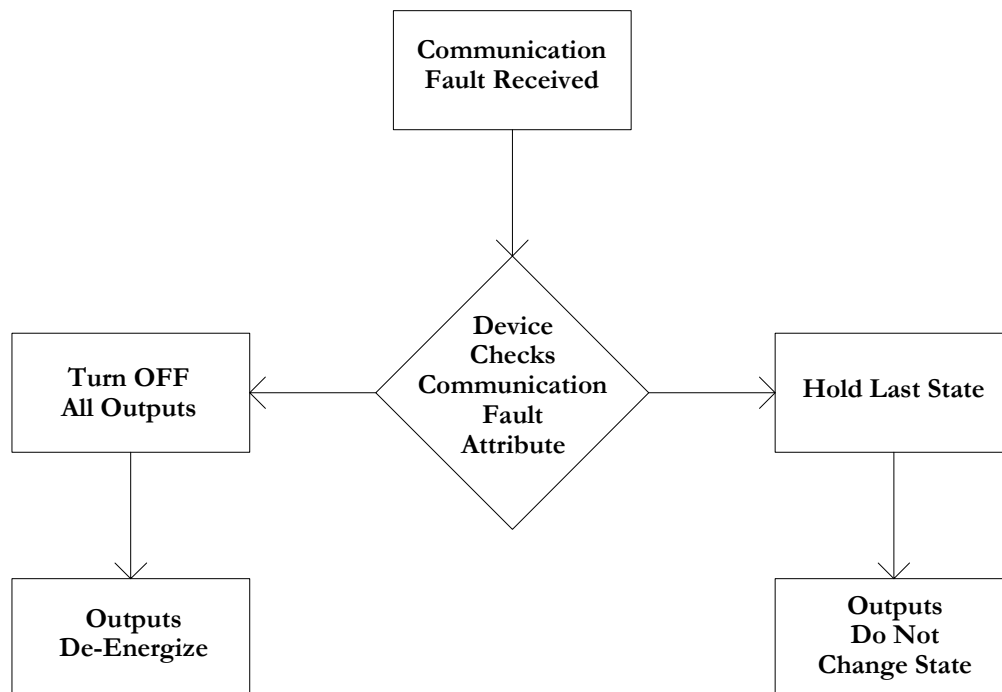

13. EtherNet/IP[™] Mapping

13.1 I/O Sizes

Manifold

Outputs

Outputs are defined as any valve solenoid coil and/or any discrete output point from any output module. The output size depends upon the physical configuration of the manifold (i.e. module type and how many are used). Please reference the following pages for a detailed explanation for calculating the output size.

Inputs

Inputs are defined as physical input bits from input modules and status bits (i.e. diagnostic word generated by the node, status input bits produced by output drivers and SCP status bits). Thus, the input size will include physical input points, as well as status input bits. Please reference the following pages for a detailed explanation for calculating the input size.

Valve Side

The size for the "valve side" of the manifold consists of an output bit for each valve solenoid coil driver and an input bit for the corresponding diagnostic status input bit. This value for the valve side size is 4 bytes of inputs and 4 bytes of outputs.

Discrete Side

The discrete side of the manifold is defined as all I/O modules connected to the left of the communication node. This includes physically attached modules as well as any distributed sub-bus modules. I/O sizes for the discrete side are automatically configured based on the I/O module type installed. However, the user can affect these sizes manually via settable parameters on the node. The output value consists of physical outputs (i.e. output bit for each output point). The input value consists of physical inputs (i.e. input bit for each input point) and user settable status input bits for corresponding physical outputs and SCP status bits.

Total I/O Size

The overall size of the I/O data for the manifold will consist of the valve size plus the discrete I/O size and all enabled Diagnostic bits. The I/O size can vary greatly, due to the many physical configuration and user settable parameters combinations. The worksheet on page 12-130 will allow accurate sizing of the I/O data.

numatics G3 Series EtherNet/IP™ Technical Manual

13.2 Manifold and I/O Data Sizing Worksheet

Step

- 1** : Choose appropriate value and place the corresponding Input and Output values in the boxes labeled, "Valve Byte Requirements" at the bottom of the page
- 2** : Choose up to sixteen modules to be included on the discrete I/O side of the manifold and place sum of the corresponding input bytes and output bytes in the boxes labeled, "Sub-Bus Byte Requirements" at the bottom of the page.
- 3** : Total the input bytes and output bytes values from the boxes labeled "Sub-Bus Byte Requirements" and "Valve Byte Requirements" in the boxes labeled "Total Input and Output Bytes for Manifold. This is the total input and output byte values required for the configured manifold.

Valve Side					
Step	Valve Side		Input Bytes		Output Bytes
			Status Enabled	Status Disabled	
1	Up to 32 Solenoid Coils		4	0	4

Digital Modules					
Step	Module No.	Description	Input Bytes		Output Bytes
			Status Enabled	Status Disabled	
2	240-203/204	16 Inputs - Terminal Strip	3	2	0
	240-205/209	16 Inputs - 8 x 12mm	3	2	0
	240-206/210	8 Inputs - 8 x 12mm	2	1	0
	240-207	16 Outputs - 8 x 12mm	2	0	2
	240-208	8 Outputs - 8 x 12mm	1	0	1
	240-211	8 Inputs / 8 Outputs - 8 x 12mm	3	1	1
	240-241	Sub - Bus Valve Output	4	0	4
	240-300	High Current 8 Outputs - 8 x 12mm	1	0	1

Analog Modules					
Step	Module No.	Description	Input Bytes		Output Bytes
			Status Enabled	Status Disabled	
2	240-212/214	4 Inputs	10	8	0
	240-213/215/307	2 Inputs/ 2 Outputs	6	4	4

Total Input/Output Size Calculation					
Step	Module Position	Model Number	Input Bytes	Output Bytes	
2	1 st				
	2 nd				
	3 rd				
	4 th				
	5 th				
	6 th				
	7 th				
	8 th				
	9 th				
	10 th				
	11 th				
	12 th				
	13 th				
	14 th				
	15 th				
	16 th				
	Sub-Bus Byte Requirements:				
	Optional Diagnostic Word:		2	0	
1	Valve Byte Requirements:				
3	Total Input and Output Bytes for Manifold				

NUMATICS™ G3 Series EtherNet/IP™ Technical Manual

13.3 Bit Mapping Rules

The bit mapping for a G3 manifold varies with the physical configuration of the manifold. The following is a breakdown of the bit mapping rules associated with the ASCO Numatics valve manifold.

Valve Side

- 1) Solenoid coil outputs are connected to the valve coils using the Z-Boards™.
- 2) The valve solenoid coil output portion of the total output size is fixed at 4 bytes.
- 3) Each solenoid coil output has an associated status input bit (refer to the section labeled, "Output Short Circuit Protection", on page 26 for functional details). The solenoid coil status input size is fixed at 4 bytes.
- 4) Solenoid coil output addressing begins at the 1st manifold station nearest the node using "14" coil 1st and then, if applicable, the "12" coil, and continues in ascending order away from the communication node.
- 5) Each manifold station allocates 1 or 2 output bits. This is dependent on the Z-Board™ type installed. A single Z-Board™ allocates 1 output bit. A double Z-Board™ allocates 2 output bits.
- 6) Z-Boards™ can be used in any arrangement (all singles, all doubles, or any combination) as long as output group No.1 and output group No. 2 bits do not overlap (i.e. combinations of Z-Boards™ could exist where the physical configuration of the manifold could exceed the output capacity).



NOTE!

- *Single solenoid valves can be used with double Z-Boards™. However, one of the two available outputs will remain unused.*

Discrete I/O Side

Outputs

- 1) The Sub-Bus output byte size portion is self-configuring in byte increments, after an output module is installed on the Sub-Bus and power is applied.
- 2) Outputs are mapped consecutively by module. The output bits from the 1st module will be mapped directly after the bits from the valve coils. The output bits from the second module will be mapped directly after the output bits from the 1st module and so on.

Inputs

- 1) The Sub-Bus input byte size portion is self-configuring in byte increments, after an input module is plugged into back plane and power is applied.
- 2) Inputs are mapped consecutively by module. The input bits from the 1st module will be mapped directly after the status bits from the valve side. The input bits from the second module will be mapped directly after the input bits from the 1st module and so on.
- 3) All of the modules have associated internal status bits, which will affect the total value of input bytes.
- 4) When a module has discrete and status inputs, the status bits are mapped after the discrete input bits.

NUMATICS G3 Series EtherNet/IP™ Technical Manual

I/O Mapping Examples

Assumed Settings

13.4 Example No. 1

- Double Z-Boards™ used with all valves
- I/O Modules and mapping schemes are identified by their corresponding color.
- I/O Status bits are enabled
- Diagnostic Word is enabled

Manifold I/O Configuration

Pos No.	Module Type	Part No.	In	Out
			Bytes	
1	16I PNP	240-205	3	0
2	4AI Analog	240-212	10	0
Diagnostic Word			2	0
Local Valve Size			4	4

Total: 19 4

How to Order

Qty	Part Number
1	AK3EF00003NDRM
3	051BA4Z2MN00061
3	051BB4Z2MN00061
1	G3EP102R0G32
1	240-205
1	240-212
	ASSEMBLED

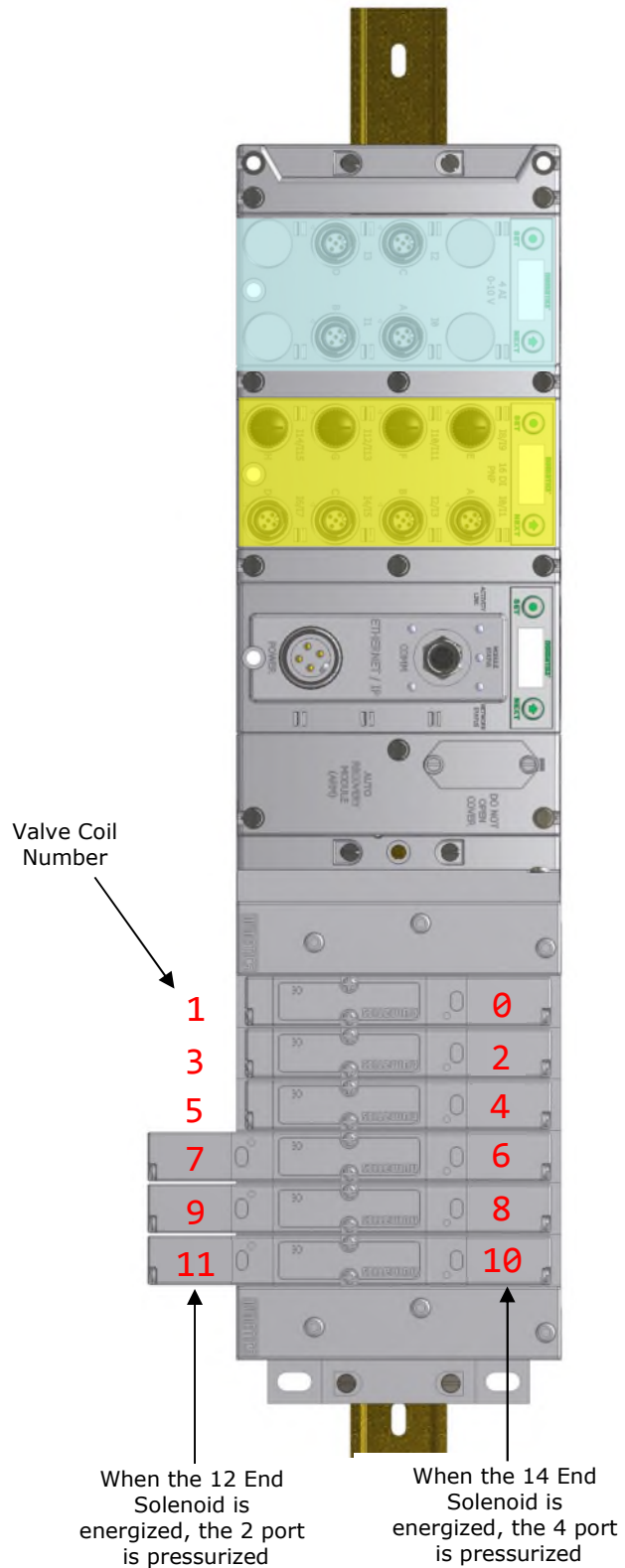

numatics G3 Series EtherNet/IP™ Technical Manual

Example No. 1 Table

Output Table								
BYTE	Bit 7	Bit 6	Bit 5	Bit 4	Bit 3	Bit 2	Bit 1	Bit 0
0	Valve Coil No. 7	Valve Coil No. 6	Valve Coil No. 5	Valve Coil No. 4	Valve Coil No. 3	Valve Coil No. 2	Valve Coil No. 1	Valve Coil No. 0
1	Allocated and Reserved	Allocated and Reserved	Allocated and Reserved	Allocated and Reserved	Valve Coil No. 11	Valve Coil No. 10	Valve Coil No. 9	Valve Coil No. 8
2	Allocated and Reserved	Allocated and Reserved	Allocated and Reserved	Allocated and Reserved	Allocated and Reserved	Allocated and Reserved	Allocated and Reserved	Allocated and Reserved
3	Allocated and Reserved	Allocated and Reserved	Allocated and Reserved	Allocated and Reserved	Allocated and Reserved	Allocated and Reserved	Allocated and Reserved	Allocated and Reserved

Input Table								
BYTE	Bit 7	Bit 6	Bit 5	Bit 4	Bit 3	Bit 2	Bit 1	Bit 0
0 (Optional)	Comm. Module Diagnostic Bit	Comm. Module Diagnostic Bit	Comm. Module Diagnostic Bit	Comm. Module Diagnostic Bit	Comm. Module Diagnostic Bit	Comm. Module Diagnostic Bit	Comm. Module Diagnostic Bit	Comm. Module Diagnostic Bit
1 (Optional)	Sub-bus Diagnostic Bit	Sub-bus Diagnostic Bit	Sub-bus Diagnostic Bit	Sub-bus Diagnostic Bit	Sub-bus Diagnostic Bit	Sub-bus Diagnostic Bit	Sub-bus Diagnostic Bit	Sub-bus Diagnostic Bit
2 (Optional)	Coil No. 7 Status	Coil No. 6 Status	Coil No. 5 Status	Coil No. 4 Status	Coil No. 3 Status	Coil No. 2 Status	Coil No. 1 Status	Coil No. 0 Status
3 (Optional)	Allocated and Reserved	Allocated and Reserved	Allocated and Reserved	Allocated and Reserved	Coil No. 11 Status	Coil No. 10 Status	Coil No. 9 Status	Coil No. 8 Status
4 (Optional)	Allocated and Reserved	Allocated and Reserved	Allocated and Reserved	Allocated and Reserved	Allocated and Reserved	Allocated and Reserved	Allocated and Reserved	Allocated and Reserved
5 (Optional)	Allocated and Reserved	Allocated and Reserved	Allocated and Reserved	Allocated and Reserved	Allocated and Reserved	Allocated and Reserved	Allocated and Reserved	Allocated and Reserved
6	Discrete Input No. 7	Discrete Input No. 6	Discrete Input No. 5	Discrete Input No. 4	Discrete Input No. 3	Discrete Input No. 2	Discrete Input No. 1	Discrete Input No. 0
7	Discrete Input No. 15	Discrete Input No. 14	Discrete Input No. 13	Discrete Input No. 12	Discrete Input No. 11	Discrete Input No. 10	Discrete Input No. 9	Discrete Input No. 8
8 (Optional)	Power Status for Conn. H	Power Status for Conn. G	Power Status for Conn. F	Power Status for Conn. E	Power Status for Conn. D	Power Status for Conn. C	Power Status for Conn. B	Power Status for Conn. A
9	Analog Input No. 1	Analog Input No. 1	Analog Input No. 1	Analog Input No. 1	Analog Input No. 1	Analog Input No. 1	Analog Input No. 1	Analog Input No. 1 (LSB)
10	Analog Input No. 1 (MSB)	Analog Input No. 1	Analog Input No. 1	Analog Input No. 1	Analog Input No. 1	Analog Input No. 1	Analog Input No. 1	Analog Input No. 1
11	Analog Input No. 2	Analog Input No. 2	Analog Input No. 2	Analog Input No. 2	Analog Input No. 2	Analog Input No. 2	Analog Input No. 2	Analog Input No. 2 (LSB)
12	Analog Input No. 2 (MSB)	Analog Input No. 2	Analog Input No. 2	Analog Input No. 2	Analog Input No. 2	Analog Input No. 2	Analog Input No. 2	Analog Input No. 2
13	Analog Input No. 3	Analog Input No. 3	Analog Input No. 3	Analog Input No. 3	Analog Input No. 3	Analog Input No. 3	Analog Input No. 3	Analog Input No. 3 (LSB)
14	Analog Input No. 3 (MSB)	Analog Input No. 3	Analog Input No. 3	Analog Input No. 3	Analog Input No. 3	Analog Input No. 3	Analog Input No. 3	Analog Input No. 3
15	Analog Input No. 4	Analog Input No. 4	Analog Input No. 4	Analog Input No. 4	Analog Input No. 4	Analog Input No. 4	Analog Input No. 4	Analog Input No. 4 (LSB)
16	Analog Input No. 4 (MSB)	Analog Input No. 4	Analog Input No. 4	Analog Input No. 4	Analog Input No. 4	Analog Input No. 4	Analog Input No. 4	Analog Input No. 4
17 (Optional)	Allocated and Reserved	Allocated and Reserved	Allocated and Reserved	Allocated and Reserved	Power Status for Conn. D	Power Status for Conn. C	Power Status for Conn. B	Power Status for Conn. A
18 (Optional)	High Alarm for Conn. D	Low Alarm for Conn. D	High Alarm for Conn. C	Low Alarm for Conn. C	High Alarm for Conn. B	Low Alarm for Conn. B	High Alarm for Conn. A	Low Alarm for Conn. A

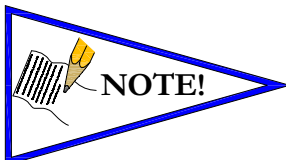

• The Comm. Module Diagnostic Bits, Sub-Bus Diagnostic Bits, Coil Status Bits and Power Status Bits are optional. The factory default condition is Diagnostic bits enabled. These bits may be disabled to optimize the logical size of the manifold.

NUMATICS G3 Series EtherNet/IP™ Technical Manual

Assumed Settings

13.5 Example No. 2

- Double Z-Boards™ used with all valves
- I/O Modules and mapping schemes are identified by their corresponding color.
- I/O Status bits are enabled
- Diagnostic Word is enabled

Manifold I/O Configuration

Pos. No.	Module Type	Part No.	In	Out
			Bytes	
		Diagnostic Word	2	0
		Local Valve Size:	4	4
		Total:	6	4

How to Order

Qty	Part Number
1	AK3EF00003NDRM
3	051BA4Z2MN00061
3	051BB4Z2MN00061
1	G3EP100R0G32
	ASSEMBLED

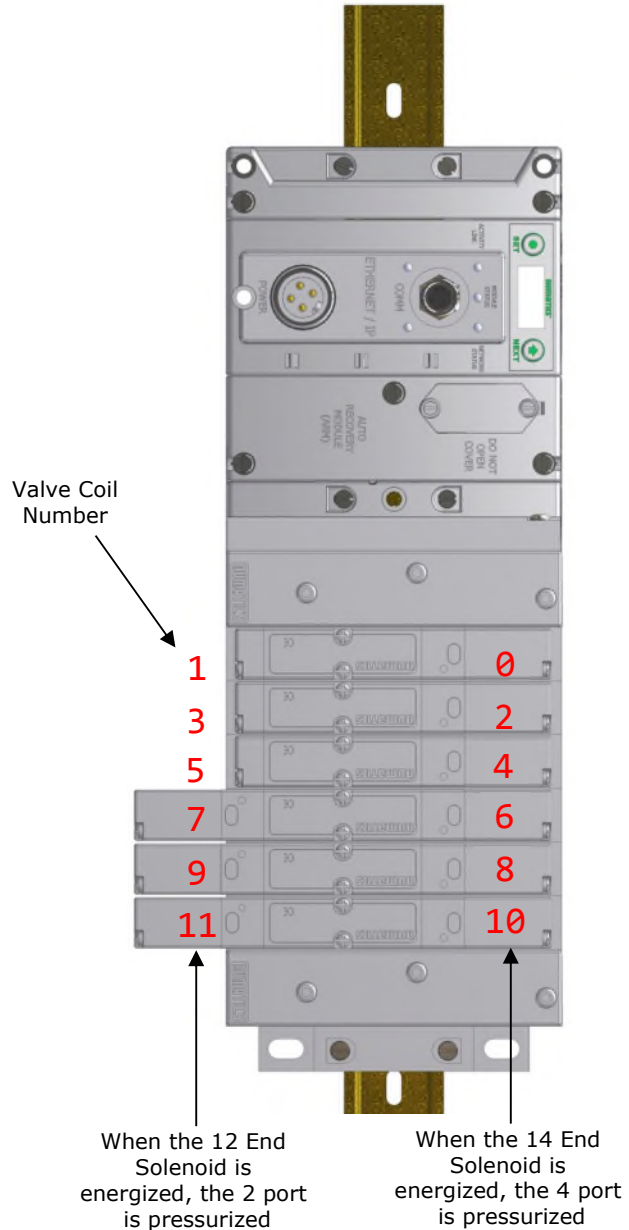

numatics G3 Series EtherNet/IP™ Technical Manual

Example No. 2 Table

<i>Output Table</i>								
BYTE	Bit 7	Bit 6	Bit 5	Bit 4	Bit 3	Bit 2	Bit 1	Bit 0
0	Valve Coil No. 7	Valve Coil No. 6	Valve Coil No. 5	Valve Coil No. 4	Valve Coil No. 3	Valve Coil No. 2	Valve Coil No. 1	Valve Coil No. 0
1	Allocated and Reserved	Allocated and Reserved	Allocated and Reserved	Allocated and Reserved	Valve Coil No. 11	Valve Coil No. 10	Valve Coil No. 9	Valve Coil No. 8
2	Allocated and Reserved	Allocated and Reserved	Allocated and Reserved	Allocated and Reserved	Allocated and Reserved	Allocated and Reserved	Allocated and Reserved	Allocated and Reserved
3	Allocated and Reserved	Allocated and Reserved	Allocated and Reserved	Allocated and Reserved	Allocated and Reserved	Allocated and Reserved	Allocated and Reserved	Allocated and Reserved

<i>Input Table</i>								
BYTE	Bit 7	Bit 6	Bit 5	Bit 4	Bit 3	Bit 2	Bit 1	Bit 0
0 (Optional)	Comm. Module Diagnostic Bit	Comm. Module Diagnostic Bit	Comm. Module Diagnostic Bit	Comm. Module Diagnostic Bit	Comm. Module Diagnostic Bit	Comm. Module Diagnostic Bit	Comm. Module Diagnostic Bit	Comm. Module Diagnostic Bit
1 (Optional)	Sub-bus Diagnostic Bit	Sub-bus Diagnostic Bit	Sub-bus Diagnostic Bit	Sub-bus Diagnostic Bit	Sub-bus Diagnostic Bit	Sub-bus Diagnostic Bit	Sub-bus Diagnostic Bit	Sub-bus Diagnostic Bit
2 (Optional)	Coil No. 7 Status	Coil No. 6 Status	Coil No. 5 Status	Coil No. 4 Status	Coil No. 3 Status	Coil No. 2 Status	Coil No. 1 Status	Coil No. 0 Status
3 (Optional)	Coil No. 15 Status	Coil No. 14 Status	Coil No. 13 Status	Coil No. 12 Status	Coil No. 11 Status	Coil No. 10 Status	Coil No. 9 Status	Coil No. 8 Status
4 (Optional)	Coil No. 23 Status	Coil No. 22 Status	Coil No. 21 Status	Coil No. 20 Status	Coil No. 19 Status	Coil No. 18 Status	Coil No. 17 Status	Coil No. 16 Status
5 (Optional)	Coil No. 31 Status	Coil No. 30 Status	Coil No. 29 Status	Coil No. 28 Status	Coil No. 27 Status	Coil No. 26 Status	Coil No. 25 Status	Coil No. 24 Status



- *The Comm. Module Diagnostic Bits, Sub-Bus Diagnostic Bits, Coil Status Bits and Power Status Bits are optional. The factory default condition is Diagnostic bits are enabled. These bits may be disabled to optimize the logical size of the manifold*

NUMATICS™ G3 Series EtherNet/IP™ Technical Manual

Assumed Settings

13.6 Example No. 3

- Double Z-Boards™ used with all valves
- I/O Modules and mapping schemes are identified by their corresponding color.
- I/O Status bits are enabled
- Diagnostic Word is enabled

Manifold I/O Configuration

Pos No.	Module Type	Part No.	In	Out
			Bytes	
1	16I PNP	240-205	3	0
2	4AI Analog	240-212	10	0
3	16I PNP	240-203	3	0
Diagnostic Word			2	0
Local Valves:			4	4
Total:			22	4

How to Order

Qty	Part Number
1	AK3EF00003NDRM
3	051BA4Z2MN00061
3	051BB4Z2MN00061
1	G3EP103D0G32
1	240-205
1	240-212
1	240-203
	ASSEMBLED

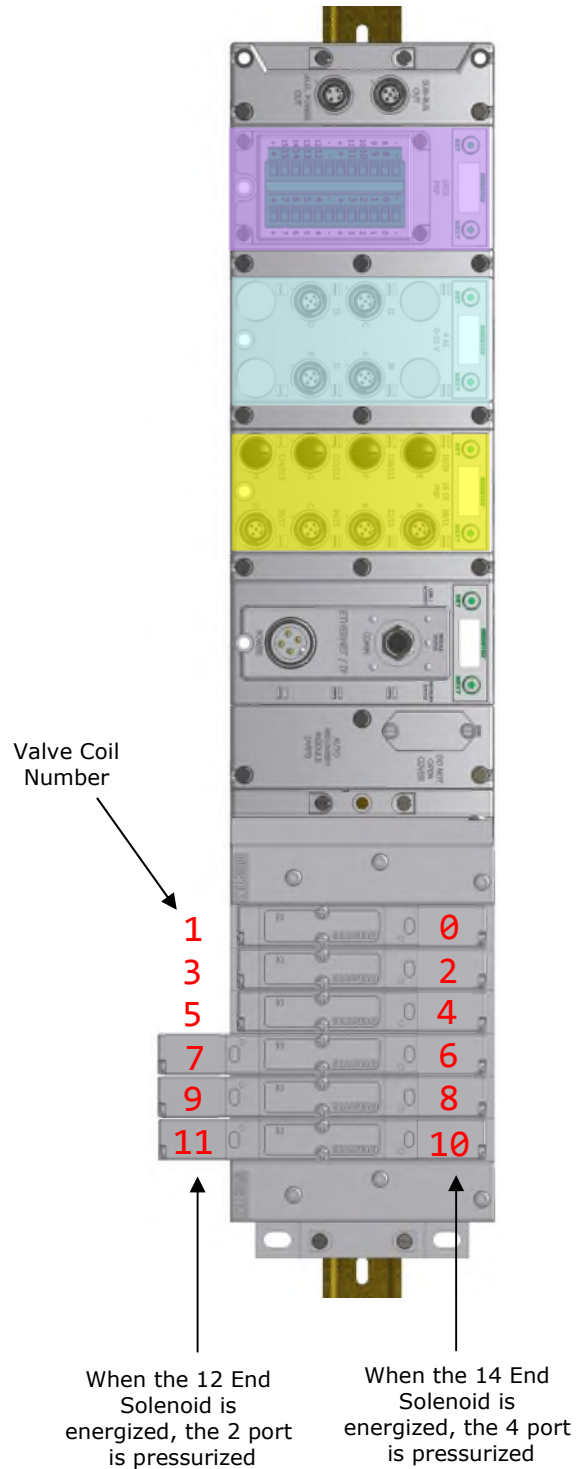

numatics G3 Series EtherNet/IP™ Technical Manual

Example No. 3 Table

Output Table								
BYTE	Bit 7	Bit 6	Bit 5	Bit 4	Bit 3	Bit 2	Bit 1	Bit 0
0	Valve Coil No. 7	Valve Coil No. 6	Valve Coil No. 5	Valve Coil No. 4	Valve Coil No. 3	Valve Coil No. 2	Valve Coil No. 1	Valve Coil No. 0
1	Allocated and Reserved	Allocated and Reserved	Allocated and Reserved	Allocated and Reserved	Valve Coil No. 11	Valve Coil No. 10	Valve Coil No. 9	Valve Coil No. 8
2	Allocated and Reserved	Allocated and Reserved	Allocated and Reserved	Allocated and Reserved	Allocated and Reserved	Allocated and Reserved	Allocated and Reserved	Allocated and Reserved
3	Allocated and Reserved	Allocated and Reserved	Allocated and Reserved	Allocated and Reserved	Allocated and Reserved	Allocated and Reserved	Allocated and Reserved	Allocated and Reserved

Input Table								
BYTE	Bit 7	Bit 6	Bit 5	Bit 4	Bit 3	Bit 2	Bit 1	Bit 0
0 (Optional)	Comm. Module Diagnostic Bit	Comm. Module Diagnostic Bit	Comm. Module Diagnostic Bit	Comm. Module Diagnostic Bit	Comm. Module Diagnostic Bit	Comm. Module Diagnostic Bit	Comm. Module Diagnostic Bit	Comm. Module Diagnostic Bit
1 (Optional)	Sub-bus Diagnostic Bit	Sub-bus Diagnostic Bit	Sub-bus Diagnostic Bit	Sub-bus Diagnostic Bit	Sub-bus Diagnostic Bit	Sub-bus Diagnostic Bit	Sub-bus Diagnostic Bit	Sub-bus Diagnostic Bit
2 (Optional)	Coil No. 7 Status	Coil No. 6 Status	Coil No. 5 Status	Coil No. 4 Status	Coil No. 3 Status	Coil No. 2 Status	Coil No. 1 Status	Coil No. 0 Status
3 (Optional)	Coil No. 15 Status	Coil No. 14 Status	Coil No. 13 Status	Coil No. 12 Status	Coil No. 11 Status	Coil No. 10 Status	Coil No. 9 Status	Coil No. 8 Status
4 (Optional)	Coil No. 23 Status	Coil No. 22 Status	Coil No. 21 Status	Coil No. 20 Status	Coil No. 19 Status	Coil No. 18 Status	Coil No. 17 Status	Coil No. 16 Status
5 (Optional)	Coil No. 31 Status	Coil No. 30 Status	Coil No. 29 Status	Coil No. 28 Status	Coil No. 27 Status	Coil No. 26 Status	Coil No. 25 Status	Coil No. 24 Status
6	Discrete Input No. 7	Discrete Input No. 6	Discrete Input No. 5	Discrete Input No. 4	Discrete Input No. 3	Discrete Input No. 2	Discrete Input No. 1	Discrete Input No. 0
7	Discrete Input No. 15	Discrete Input No. 14	Discrete Input No. 13	Discrete Input No. 12	Discrete Input No. 11	Discrete Input No. 10	Discrete Input No. 9	Discrete Input No. 8
8 (Optional)	Power Status for Conn. H	Power Status for Conn. G	Power Status for Conn. F	Power Status for Conn. E	Power Status for Conn. D	Power Status for Conn. C	Power Status for Conn. B	Power Status for Conn. A
9	Analog Input No. 1	Analog Input No. 1	Analog Input No. 1	Analog Input No. 1	Analog Input No. 1	Analog Input No. 1	Analog Input No. 1	Analog Input No. 1 (LSB)
10	Analog Input No. 1 (MSB)	Analog Input No. 1	Analog Input No. 1	Analog Input No. 1	Analog Input No. 1	Analog Input No. 1	Analog Input No. 1	Analog Input No. 1
11	Analog Input No. 2	Analog Input No. 2	Analog Input No. 2	Analog Input No. 2	Analog Input No. 2	Analog Input No. 2	Analog Input No. 2	Analog Input No. 2 (LSB)
12	Analog Input No. 2 (MSB)	Analog Input No. 2	Analog Input No. 2	Analog Input No. 2	Analog Input No. 2	Analog Input No. 2	Analog Input No. 2	Analog Input No. 2
13	Analog Input No. 3	Analog Input No. 3	Analog Input No. 3	Analog Input No. 3	Analog Input No. 3	Analog Input No. 3	Analog Input No. 3	Analog Input No. 3 (LSB)
14	Analog Input No. 3 (MSB)	Analog Input No. 3	Analog Input No. 3	Analog Input No. 3	Analog Input No. 3	Analog Input No. 3	Analog Input No. 3	Analog Input No. 3
15	Analog Input No. 4	Analog Input No. 4	Analog Input No. 4	Analog Input No. 4	Analog Input No. 4	Analog Input No. 4	Analog Input No. 4	Analog Input No. 4 (LSB)
16	Analog Input No. 4 (MSB)	Analog Input No. 4	Analog Input No. 4	Analog Input No. 4	Analog Input No. 4	Analog Input No. 4	Analog Input No. 4	Analog Input No. 4
17 (Optional)	Allocated and Reserved	Allocated and Reserved	Allocated and Reserved	Allocated and Reserved	Power Status for Conn. D	Power Status for Conn. C	Power Status for Conn. B	Power Status for Conn. A
18 (Optional)	High Alarm for Conn. D	Low Alarm for Conn. D	High Alarm for Conn. C	Low Alarm for Conn. C	High Alarm for Conn. B	Low Alarm for Conn. B	High Alarm for Conn. A	Low Alarm for Conn. A
19	Discrete Input No. 7	Discrete Input No. 6	Discrete Input No. 5	Discrete Input No. 4	Discrete Input No. 3	Discrete Input No. 2	Discrete Input No. 1	Discrete Input No. 0
20	Discrete Input No. 15	Discrete Input No. 14	Discrete Input No. 13	Discrete Input No. 12	Discrete Input No. 11	Discrete Input No. 10	Discrete Input No. 9	Discrete Input No. 8
21 (Optional)	Power Status for Conn. H	Power Status for Conn. G	Power Status for Conn. F	Power Status for Conn. E	Power Status for Conn. D	Power Status for Conn. C	Power Status for Conn. B	Power Status for Conn. A

NUMATICS G3 Series EtherNet/IP™ Technical Manual

Assumed Settings

13.7 Example No. 4

- Double Z-Boards™ used with all valves
- I/O Modules and mapping schemes are identified by their corresponding color.
- I/O Status bits are enabled
- Diagnostic Word is enabled

Manifold I/O Configuration

Pos No.	Module Type	Part No.	In Out	
			Bytes	
1	16I PNP	240-205	3	0
2	4I Analog	240-212	10	0
3	16I PNP	240-205	3	0
4	16I PNP	240-205	3	0
Diagnostic Word			2	0
Local Valves:			4	4
Total:			18	4

How to Order

Qty	Part Number
1	AK3EF00003NDRM
3	051BA4Z2MN00061
3	051BB4Z2MN00061
1	G3EP102R0G32
1	240-205
1	240-212
	ASSEMBLED

1	G3DS302D0DRM
1	240-205
1	240-205
	ASSEMBLED

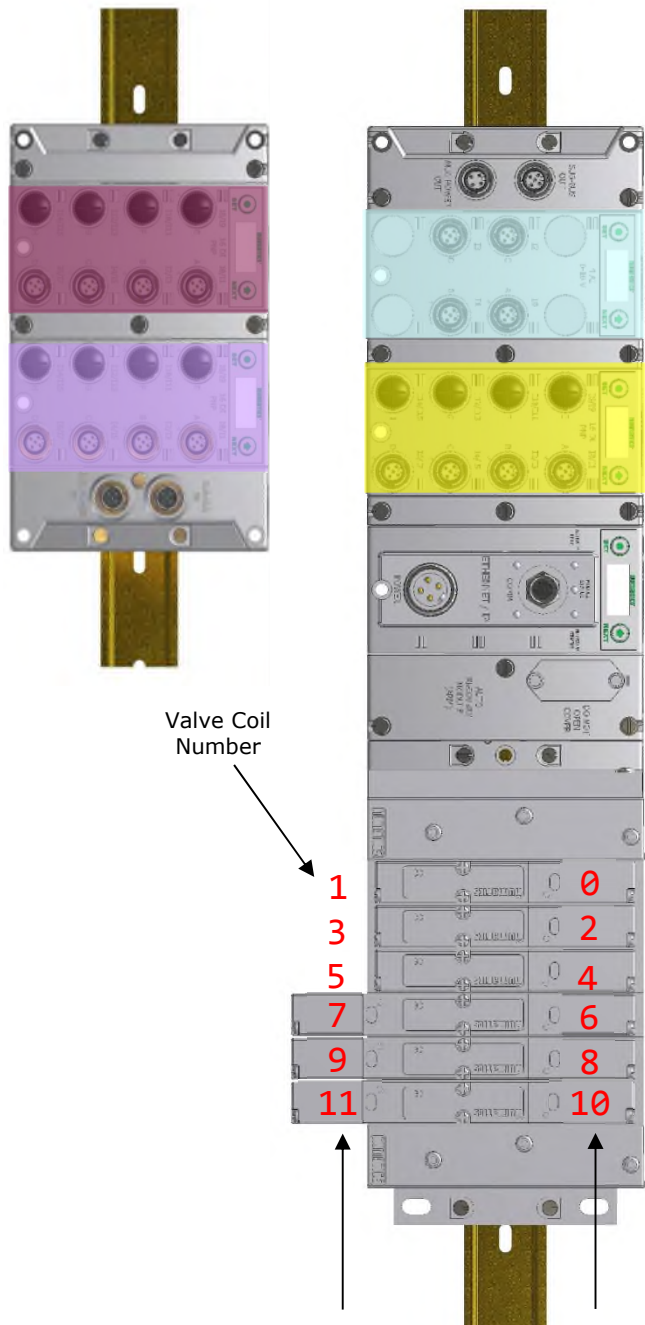

When the 12 End Solenoid is energized, the 2 port is pressurized

When the 14 End Solenoid is energized, the 4 port is pressurized

numatics G3 Series EtherNet/IP™ Technical Manual

Example No. 4 Table

Output Table								
BYTE	Bit 7	Bit 6	Bit 5	Bit 4	Bit 3	Bit 2	Bit 1	Bit 0
0	Valve Coil No. 7	Valve Coil No. 6	Valve Coil No. 5	Valve Coil No. 4	Valve Coil No. 3	Valve Coil No. 2	Valve Coil No. 1	Valve Coil No. 0
1	Allocated and Reserved	Allocated and Reserved	Allocated and Reserved	Allocated and Reserved	Valve Coil No. 11	Valve Coil No. 10	Valve Coil No. 9	Valve Coil No. 8
2	Allocated and Reserved	Allocated and Reserved	Allocated and Reserved	Allocated and Reserved	Allocated and Reserved	Allocated and Reserved	Allocated and Reserved	Allocated and Reserved
3	Allocated and Reserved	Allocated and Reserved	Allocated and Reserved	Allocated and Reserved	Allocated and Reserved	Allocated and Reserved	Allocated and Reserved	Allocated and Reserved

Input Table								
BYTE	Bit 7	Bit 6	Bit 5	Bit 4	Bit 3	Bit 2	Bit 1	Bit 0
0 (Optional)	Comm. Module Diagnostic Bit	Comm. Module Diagnostic Bit	Comm. Module Diagnostic Bit	Comm. Module Diagnostic Bit	Comm. Module Diagnostic Bit	Comm. Module Diagnostic Bit	Comm. Module Diagnostic Bit	Comm. Module Diagnostic Bit
1 (Optional)	Sub-bus Diagnostic Bit	Sub-bus Diagnostic Bit	Sub-bus Diagnostic Bit	Sub-bus Diagnostic Bit	Sub-bus Diagnostic Bit	Sub-bus Diagnostic Bit	Sub-bus Diagnostic Bit	Sub-bus Diagnostic Bit
2 (Optional)	Coil No. 7 Status	Coil No. 6 Status	Coil No. 5 Status	Coil No. 4 Status	Coil No. 3 Status	Coil No. 2 Status	Coil No. 1 Status	Coil No. 0 Status
3 (Optional)	Coil No. 15 Status	Coil No. 14 Status	Coil No. 13 Status	Coil No. 12 Status	Coil No. 11 Status	Coil No. 10 Status	Coil No. 9 Status	Coil No. 8 Status
4 (Optional)	Coil No. 23 Status	Coil No. 22 Status	Coil No. 21 Status	Coil No. 20 Status	Coil No. 19 Status	Coil No. 18 Status	Coil No. 17 Status	Coil No. 16 Status
5 (Optional)	Coil No. 31 Status	Coil No. 30 Status	Coil No. 29 Status	Coil No. 28 Status	Coil No. 27 Status	Coil No. 26 Status	Coil No. 25 Status	Coil No. 24 Status
6	Discrete Input No. 7	Discrete Input No. 6	Discrete Input No. 5	Discrete Input No. 4	Discrete Input No. 3	Discrete Input No. 2	Discrete Input No. 1	Discrete Input No. 0
7	Discrete Input No. 15	Discrete Input No. 14	Discrete Input No. 13	Discrete Input No. 12	Discrete Input No. 11	Discrete Input No. 10	Discrete Input No. 9	Discrete Input No. 8
8 (Optional)	Power Status for Conn. H	Power Status for Conn. G	Power Status for Conn. F	Power Status for Conn. E	Power Status for Conn. D	Power Status for Conn. C	Power Status for Conn. B	Power Status for Conn. A
9	Analog Input No. 1	Analog Input No. 1	Analog Input No. 1	Analog Input No. 1	Analog Input No. 1	Analog Input No. 1	Analog Input No. 1	Analog Input No. 1 (LSB)
10	Analog Input No. 1 (MSB)	Analog Input No. 1	Analog Input No. 1	Analog Input No. 1	Analog Input No. 1	Analog Input No. 1	Analog Input No. 1	Analog Input No. 1
11	Analog Input No. 2	Analog Input No. 2	Analog Input No. 2	Analog Input No. 2	Analog Input No. 2	Analog Input No. 2	Analog Input No. 2	Analog Input No. 2 (LSB)
12	Analog Input No. 2 (MSB)	Analog Input No. 2	Analog Input No. 2	Analog Input No. 2	Analog Input No. 2	Analog Input No. 2	Analog Input No. 2	Analog Input No. 2
13	Analog Input No. 3	Analog Input No. 3	Analog Input No. 3	Analog Input No. 3	Analog Input No. 3	Analog Input No. 3	Analog Input No. 3	Analog Input No. 3 (LSB)
14	Analog Input No. 3 (MSB)	Analog Input No. 3	Analog Input No. 3	Analog Input No. 3	Analog Input No. 3	Analog Input No. 3	Analog Input No. 3	Analog Input No. 3
15	Analog Input No. 4	Analog Input No. 4	Analog Input No. 4	Analog Input No. 4	Analog Input No. 4	Analog Input No. 4	Analog Input No. 4	Analog Input No. 4 (LSB)
16	Analog Input No. 4 (MSB)	Analog Input No. 4	Analog Input No. 4	Analog Input No. 4	Analog Input No. 4	Analog Input No. 4	Analog Input No. 4	Analog Input No. 4
17 (Optional)	Allocated and Reserved	Allocated and Reserved	Allocated and Reserved	Allocated and Reserved	Power Status for Conn. D	Power Status for Conn. C	Power Status for Conn. B	Power Status for Conn. A
18 (Optional)	High Alarm for Conn. D	Low Alarm for Conn. D	High Alarm for Conn. C	Low Alarm for Conn. C	High Alarm for Conn. B	Low Alarm for Conn. B	High Alarm for Conn. A	Low Alarm for Conn. A
19	Discrete Input No. 7	Discrete Input No. 6	Discrete Input No. 5	Discrete Input No. 4	Discrete Input No. 3	Discrete Input No. 2	Discrete Input No. 1	Discrete Input No. 0
20	Discrete Input No. 15	Discrete Input No. 14	Discrete Input No. 13	Discrete Input No. 12	Discrete Input No. 11	Discrete Input No. 10	Discrete Input No. 9	Discrete Input No. 8
21 (Optional)	Power Status for Conn. H	Power Status for Conn. G	Power Status for Conn. F	Power Status for Conn. E	Power Status for Conn. D	Power Status for Conn. C	Power Status for Conn. B	Power Status for Conn. A
22	Discrete Input No. 7	Discrete Input No. 6	Discrete Input No. 5	Discrete Input No. 4	Discrete Input No. 3	Discrete Input No. 2	Discrete Input No. 1	Discrete Input No. 0
23	Discrete Input No. 15	Discrete Input No. 14	Discrete Input No. 13	Discrete Input No. 12	Discrete Input No. 11	Discrete Input No. 10	Discrete Input No. 9	Discrete Input No. 8
24 (Optional)	Power Status for Conn. H	Power Status for Conn. G	Power Status for Conn. F	Power Status for Conn. E	Power Status for Conn. D	Power Status for Conn. C	Power Status for Conn. B	Power Status for Conn. A



NUMATICS™ G3 Series EtherNet/IP™ Technical Manual

Assumed Settings

13.8 Example No. 5

- Double Z-Boards™ used with all valves
- I/O Modules and mapping schemes are identified by their corresponding color.
- I/O Status bits are enabled
- Diagnostic Word is enabled

Manifold I/O Configuration

Pos No.	Module Type	Part No.	In	Out
			Bytes	
1	16I PNP	240-205	3	0
2	4I Analog	240-212	10	0
Diagnostic Word			2	0
Local Valves			4	4
Local Valves (Sub-Bus)			4	4
Total:			23	8

How to Order

Qty	Part Number
1	AK3EF00003NDRM
3	051BA4Z2MN00061
3	051BB4Z2MN00061
1	G3DN102D0G32
1	240-205
1	240-212
	ASSEMBLED

1	AK3EF00003NDRM
3	051BA4Z2MN00061
3	051BB4Z2MN00061
1	G3DS202R0DRM
	ASSEMBLED

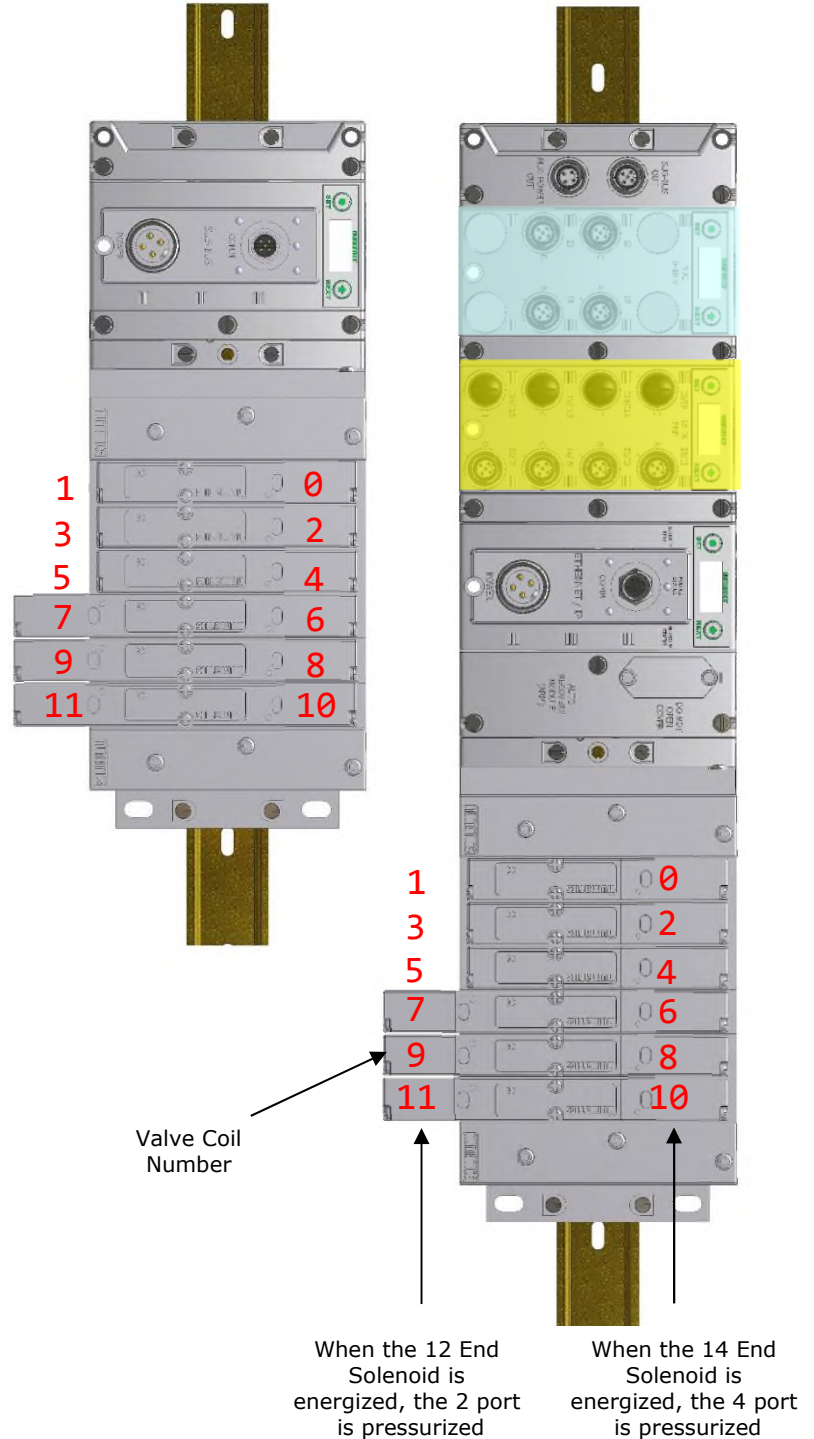

numatics G3 Series EtherNet/IP™ Technical Manual

Example No. 5 Table

Output Table								
BYTE	Bit 7	Bit 6	Bit 5	Bit 4	Bit 3	Bit 2	Bit 1	Bit 0
0	Valve Coil No. 7	Valve Coil No. 6	Valve Coil No. 5	Valve Coil No. 4	Valve Coil No. 3	Valve Coil No. 2	Valve Coil No. 1	Valve Coil No. 0
1	Allocated and Reserved	Allocated and Reserved	Allocated and Reserved	Allocated and Reserved	Valve Coil No. 11	Valve Coil No. 10	Valve Coil No. 9	Valve Coil No. 8
2	Allocated and Reserved	Allocated and Reserved	Allocated and Reserved	Allocated and Reserved	Allocated and Reserved	Allocated and Reserved	Allocated and Reserved	Allocated and Reserved
3	Allocated and Reserved	Allocated and Reserved	Allocated and Reserved	Allocated and Reserved	Allocated and Reserved	Allocated and Reserved	Allocated and Reserved	Allocated and Reserved
4	Valve Coil No. 7	Valve Coil No. 6	Valve Coil No. 5	Valve Coil No. 4	Valve Coil No. 3	Valve Coil No. 2	Valve Coil No. 1	Valve Coil No. 0
5	Allocated and Reserved	Allocated and Reserved	Allocated and Reserved	Allocated and Reserved	Valve Coil No. 11	Valve Coil No. 10	Valve Coil No. 9	Valve Coil No. 8
6 (Optional)	Allocated and Reserved	Allocated and Reserved	Allocated and Reserved	Allocated and Reserved	Allocated and Reserved	Allocated and Reserved	Allocated and Reserved	Allocated and Reserved
7 (Optional)	Allocated and Reserved	Allocated and Reserved	Allocated and Reserved	Allocated and Reserved	Allocated and Reserved	Allocated and Reserved	Allocated and Reserved	Allocated and Reserved

Input Table								
BYTE	Bit 7	Bit 6	Bit 5	Bit 4	Bit 3	Bit 2	Bit 1	Bit 0
0 (Optional)	Comm. Module Diagnostic Bit	Comm. Module Diagnostic Bit	Comm. Module Diagnostic Bit	Comm. Module Diagnostic Bit	Comm. Module Diagnostic Bit	Comm. Module Diagnostic Bit	Comm. Module Diagnostic Bit	Comm. Module Diagnostic Bit
1 (Optional)	Sub-bus Diagnostic Bit	Sub-bus Diagnostic Bit	Sub-bus Diagnostic Bit	Sub-bus Diagnostic Bit	Sub-bus Diagnostic Bit	Sub-bus Diagnostic Bit	Sub-bus Diagnostic Bit	Sub-bus Diagnostic Bit
2 (Optional)	Coil No. 7 Status	Coil No. 6 Status	Coil No. 5 Status	Coil No. 4 Status	Coil No. 3 Status	Coil No. 2 Status	Coil No. 1 Status	Coil No. 0 Status
3 (Optional)	Coil No. 15 Status	Coil No. 14 Status	Coil No. 13 Status	Coil No. 12 Status	Coil No. 11 Status	Coil No. 10 Status	Coil No. 9 Status	Coil No. 8 Status
4 (Optional)	Coil No. 23 Status	Coil No. 22 Status	Coil No. 21 Status	Coil No. 20 Status	Coil No. 19 Status	Coil No. 18 Status	Coil No. 17 Status	Coil No. 16 Status
5 (Optional)	Coil No. 31 Status	Coil No. 30 Status	Coil No. 29 Status	Coil No. 28 Status	Coil No. 27 Status	Coil No. 26 Status	Coil No. 25 Status	Coil No. 24 Status
6	Discrete Input No. 7	Discrete Input No. 6	Discrete Input No. 5	Discrete Input No. 4	Discrete Input No. 3	Discrete Input No. 2	Discrete Input No. 1	Discrete Input No. 0
7	Discrete Input No. 15	Discrete Input No. 14	Discrete Input No. 13	Discrete Input No. 12	Discrete Input No. 11	Discrete Input No. 10	Discrete Input No. 9	Discrete Input No. 8
8 (Optional)	Power Status for Conn. H	Power Status for Conn. G	Power Status for Conn. F	Power Status for Conn. E	Power Status for Conn. D	Power Status for Conn. C	Power Status for Conn. B	Power Status for Conn. A
9	Analog Input No. 1	Analog Input No. 1	Analog Input No. 1	Analog Input No. 1	Analog Input No. 1	Analog Input No. 1	Analog Input No. 1	Analog Input No. 1 (LSB)
10	Analog Input No. 1 (MSB)	Analog Input No. 1	Analog Input No. 1	Analog Input No. 1	Analog Input No. 1	Analog Input No. 1	Analog Input No. 1	Analog Input No. 1
11	Analog Input No. 2	Analog Input No. 2	Analog Input No. 2	Analog Input No. 2	Analog Input No. 2	Analog Input No. 2	Analog Input No. 2	Analog Input No. 2 (LSB)
12	Analog Input No. 2 (MSB)	Analog Input No. 2	Analog Input No. 2	Analog Input No. 2	Analog Input No. 2	Analog Input No. 2	Analog Input No. 2	Analog Input No. 2
13	Analog Input No. 3	Analog Input No. 3	Analog Input No. 3	Analog Input No. 3	Analog Input No. 3	Analog Input No. 3	Analog Input No. 3	Analog Input No. 3 (LSB)
14	Analog Input No. 3 (MSB)	Analog Input No. 3	Analog Input No. 3	Analog Input No. 3	Analog Input No. 3	Analog Input No. 3	Analog Input No. 3	Analog Input No. 3
15	Analog Input No. 4	Analog Input No. 4	Analog Input No. 4	Analog Input No. 4	Analog Input No. 4	Analog Input No. 4	Analog Input No. 4	Analog Input No. 4 (LSB)
16	Analog Input No. 4 (MSB)	Analog Input No. 4	Analog Input No. 4	Analog Input No. 4	Analog Input No. 4	Analog Input No. 4	Analog Input No. 4	Analog Input No. 4
17 (Optional)	Allocated and Reserved	Allocated and Reserved	Allocated and Reserved	Allocated and Reserved	Power Status for Conn. D	Power Status for Conn. C	Power Status for Conn. B	Power Status for Conn. A
18 (Optional)	High Alarm for Conn. D	Low Alarm for Conn. D	High Alarm for Conn. C	Low Alarm for Conn. C	High Alarm for Conn. B	Low Alarm for Conn. B	High Alarm for Conn. A	Low Alarm for Conn. A
18 (Optional)	Coil No. 7 Status	Coil No. 6 Status	Coil No. 5 Status	Coil No. 4 Status	Coil No. 3 Status	Coil No. 2 Status	Coil No. 1 Status	Coil No. 0 Status
19 (Optional)	Coil No. 15 Status	Coil No. 14 Status	Coil No. 13 Status	Coil No. 12 Status	Coil No. 11 Status	Coil No. 10 Status	Coil No. 9 Status	Coil No. 8 Status
20 (Optional)	Coil No. 23 Status	Coil No. 22 Status	Coil No. 21 Status	Coil No. 20 Status	Coil No. 19 Status	Coil No. 18 Status	Coil No. 17 Status	Coil No. 16 Status
21 (Optional)	Coil No. 31 Status	Coil No. 30 Status	Coil No. 29 Status	Coil No. 28 Status	Coil No. 27 Status	Coil No. 26 Status	Coil No. 25 Status	Coil No. 24 Status

numatics G3 Series EtherNet/IP™ Technical Manual

13.9 I/O Mapped Diagnostic Word

<i>Diagnostic Word Format</i>								
BYTE	Bit 7	Bit 6	Bit 5	Bit 4	Bit 3	Bit 2	Bit 1	Bit 0
0 (Comm. Status)	Reserved	Reserved	Reserved	Reserved	Sub-Bus Short Circuit (1 = Error)	Sub-Bus Error (1=Error)	Un-Switched Power Status (1=Error)	Switched Power Status (1=Error)
1 (Sub-Bus Status)	Error Code	Error Code	Error Code	Module Address	Module Address	Module Address	Module Address	Module Address

Byte 0 (Communication Status)

Byte 0, Bit 0 Switched Power Status = Bit is high when valve / output power is not present on the comm. module.

Byte 0, Bit 1 Un-switched Power Status = Bit is high when node / input power is below 19VDC

Byte 0, Bit 2 Sub-Bus Error = Bit is high when there is an error on the sub-bus; see "Byte 1" of diagnostic word for description.

Byte 0, Bit 3 Sub-Bus Short Circuit = A short circuit has been detected across the Sub-Bus

numatics G3 Series EtherNet/IP™ Technical Manual

I/O Mapped Diagnostic Word Continued

Byte 1 (Sub-Bus Status)

Module Address

Bit 4	Bit 3	Bit 2	Bit 1	Bit 0	Description
0	0	0	0	0	No error
0	0	0	0	1	Communication Module
0	0	0	1	0	I/O module No. 1
0	0	0	1	1	I/O module No. 2
0	0	1	0	0	I/O module No. 3
0	0	1	0	1	I/O module No. 4
0	0	1	1	0	I/O module No. 5
0	0	1	1	1	I/O module No. 6
0	1	0	0	0	I/O module No. 7
0	1	0	0	1	I/O module No. 8
0	1	0	1	0	I/O module No. 9
0	1	0	1	1	I/O module No. 10
0	1	1	0	0	I/O module No. 11
0	1	1	0	1	I/O module No. 12
0	1	1	1	0	I/O module No. 13
0	1	1	1	1	I/O module No. 14
1	0	0	0	0	I/O module No. 15
1	0	0	0	1	I/O module No. 16
1	0	0	1	1	Communication Valve driver
1	0	1	0	0	ARM
1	0	1	0	1	MCM
X	X	X	X	X	N/A

Sub-Bus Errors

Error Code	Bit 7	Bit 6	Bit 5
0	0	0	0
1	0	0	1
2	0	1	0
3	0	1	1
4	1	0	0
5	1	0	1
6	1	1	0
7	1	1	1

- Error Code 0 = No Errors
- Error Code 1 = Lost communications between I/O module and communications module
- Error Code 2 = Valve / Output power is below 19VDC
- Error Code 3...7 = not defined / reserved

14. Appendix

14.1 System Specifications

<i>Electrical</i>	
Supply Voltage	Valves (2005, 2012, 2035): 24 VDC + 10%, -15% Node and Discrete I/O: 24 VDC ± 10%
Current	Total current on the Auxiliary Power Connector ("Valves and Outputs" and "Node and Inputs" Pins) must not exceed 8 Amps.
Internal Electronic Resettable Fuses	The Auxiliary Power Connector pins are each internally fused with an electronically resettable fuse. These fuses are set to the maximum current allowable through the G3 electronics.
Recommended External Fuse	External fuses should be chosen depending upon manifold configuration. Please refer to power consumption chart on page 25 for additional fuse sizing information.
Spike Suppression	Output spike suppression is internally provided for both discrete and valve outputs.
Discrete Outputs	Maximum 0.5 Amps per output. All outputs are short circuit protected and have internal spike suppression. Contact factory for higher current requirements.
Valve Solenoid Coil Output Drivers	Maximum 0.5 Amps per output. All output points are short circuit protected and have internal spike suppression.
Operating Temperature for Electronic Components	23 to 114°F (-5 to 50°C)

NUMATICS[®] G3 Series EtherNet/IP™ Technical Manual

14.2 Factory Default Settings

<i>Description</i>	<i>Default Settings</i>
IP address	192.168.3.120 in FLASH
MAC Address	A unique alpha-numeric code for each node (00-15-24-XX-XX-XX).
Baud Rate	10/100 Mbit per sec. (Autobaud)
DHCP/BOOTP	Enabled
Communication Method	Full/Half Duplex (Auto Detect)
Valve Side Output Bytes	4 Bytes (32 Allocated Valve Coil Outputs)
Discrete I/O Side - I/O Bytes	Self-Configuring based on the I/O modules installed.

NUMATICS™ G3 Series EtherNet/IP™ Technical Manual

14.3 Troubleshooting

Communication Node

<i>Symptom</i>	<i>Possible Cause</i>	<i>Solution</i>
The wrong valve solenoid coils are being energized.	Z-Board™ type mismatch. Single Z-Board™ present where double Z-Board™ expected or vice versa.	Check that correct Z-Board™ types are installed. Check that ribbon cable (Output group No. 2) is connected to appropriate valve station. See page 137 for bit mapping rules
Valve outputs do not energize.	Output power not present or connected improperly on Auxiliary Power connector.	Check for 24VDC on the +24 VDC (Valves and Outputs) pin of the MINI Auxiliary Power connector of the Comm. module.
Unable to go to the manifold's web page.	Bad cabling, incorrect computer settings, web server disabled etc.	Please see page 110
No Activity/Link LED	No network connection	Verify the type of cable (straight-thru or crossover) that is being used. Also, verify the wiring of the cable.

I/O Modules

<i>Symptom</i>	<i>Possible Cause</i>	<i>Solution</i>
Outputs remain on when communication is lost and/or PLC is in "Program" mode.	Communication Fault parameters set incorrectly. See page 11-128.	Check the communication fault/idle mode parameter setting to ensure that it is not set to "Hold Last Output State".

numatics G3 Series EtherNet/IP™ Technical Manual

14.4 Glossary of Terms

The following is a list and description of common terms and symbols used throughout this document:

<i>Term</i>	<i>Description</i>
Address Resolution Protocol (ARP)	A protocol used to set an IP address using a MAC Address hardware address. This can be done in the command prompt window.
Bit	Smallest unit of digital information either a "0" or "1"
Bit Mapping	Chart showing which bit is connected to which physical input or output point.
Bootstrap Protocol (BOOTP)	A protocol used to set an IP Address, Subnet Mask, and Gateway using a server.
Broadcast	A transmission method that sends packets to multiple unspecified devices.
Byte	8 bits (1/2 word)
Comm. Fault	One or more of the I/O connections have timed out.
DLR	Device Level Ring
Discrete I / O	The inputs / outputs that are available via the "Discrete I/O" side of manifold.
Dynamic Host Configuration Protocol (DHCP)	A protocol used by a node to obtain an IP Address, Subnet Mask, and Gateway Address from a server.
EDS File	<u>E</u> lectronic <u>D</u> ata <u>S</u> heet. A text file, which contains specific product information, definitions of product capabilities and configurable parameters necessary for operation on an EtherNet/IP™ network.
Explicit Messaging	Messaging that sends data to perform request/response functions.
Ground	This term is used to indicate an earth or chassis ground.
I/O	Any combination of inputs and outputs
Idle	A zero (0) length poll message (i.e.: scanner in program mode)
IGMP Snooping	See Implicit Messaging
Implicit Messaging	A function that that can control I/O messaging to another I/O device.
Internet Group Management Protocol (IGMP)	A protocol used to keep local switches informed in a multicast group. Nodes that leave the group will no longer be sent packets of information from switches and routers.
Layer 2 (data link layer or level)	The data layer that physically refers to the frame format and addressing. A layer 2 address is an Ethernet address.
Layer 3 (network layer or level)	The data layer that refers to IP and the IP packet format. A layer 3 address is an IP address.
Link	A group of nodes with different MAC addresses. Segments connected by repeaters make a link. Links that are connected by routers make up a network.
MAC Address	Media Access Connection Address
MCM	<u>M</u> anual <u>C</u> onfiguration <u>M</u> odule. A module that allows configurable parameters to be set manually via DIP switches and rotary switches. Not required if software configuration is used.
Multicast	A transmission where a packet is sent to all possible nodes of a certain subset.

numatics™ G3 Series EtherNet/IP™ Technical Manual

Glossary of Terms Continued

<i>Term</i>	<i>Description</i>
NEMA	National Electrical Manufacturers Association
Network	A group of nodes connected by a communication medium through repeaters, router, and gateways.
Node	A device on the network that contains a single MAC Address, which can communicate over a subnet.
Octet	8 bits of information. An IP address is made up of four octets.
ODVA	Open DeviceNet Vendor Association (www.odva.org)
Ping	A group of messages sent between a master and a slave that coordinates time.
Ping Request	A request to see if a device has received a message.
Ping Response	Response to a ping request.
Requested Packet Interval (RPI)	The frequency measure of the required transmission of data from the originating device to the target device.
RSNetWorx	Rockwell Automation's configuration software
Segment	Nodes connected to a continuous section of communication media.
Simple Network Management Protocol (SNMP)	A protocol used to monitor EtherNet devices, switches, routers, and networks connected by communication media.
Sinking (NPN)	Method of connecting electrical circuits in which the zero (0) volt DC side is switched and the common is positive
Sourcing (PNP)	Method of connecting electrical circuits in which the positive side is switched and the common is zero (0) volts DC.
Status Input bit	A bit in the input table that reports the health of a corresponding output. Indicates short circuit or open coil (load) diagnostics
Subnet	Nodes using the same protocol and shared media access arbitration.
System	Contains one or more domains.
Time to Live (TTL)	A method used in best-effort delivery systems to negate endlessly looping packets.
Unicast	A transmission where a packet is sent to a single node.
Word	2 Bytes (16 bits)
Z-Board™	Circuit board installed in the valve manifold which electrically connects the valve solenoid to the electrical /electronics interface. Available in single or double solenoid versions.

NUMATICS[®] G3 Series EtherNet/IP[™] Technical Manual

14.5 Technical Support

For technical support, contact your local ASCO Numatics distributor. If further information is required, please call ASCO Numatics Technical Support Department at (248) 596-3333.

Issues relating to network setup, PLC programming, sequencing, software related functions, etc. should be handled with the appropriate product vendor.

Information on device files, technical manuals, local distributors, and other ASCO Numatics products and support issues can be found on the ASCO Numatics website at www.asco.com.

EtherNet*✓*IP[™]
conformance tested