

# PCON

## PCON-C/CG/CF Controller Positioner Type

Operation Manual  
Forth Edition

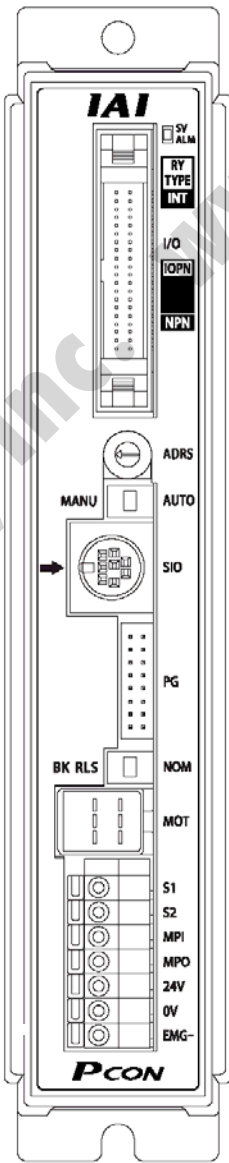

**IAI America, Inc.**

### 1. 24-V Power Supplies Required for UL Certification

PCON controllers (PCON-C/CG, CY, SE, PL/PO) are UL-certified, where one condition for the certification is to use Class 2 24-V power supplies.

Accordingly, you must use Class 2 power supplies for both the input power supply and I/O power supply for your equipment incorporating the PCON, if the equipment as a whole must be UL-certified.

### 2. Use Environment

PCON controllers can be used in an environment of pollution degree 2 or equivalent.

### 3. PC Software and Teaching Pendant Models

New functions have been added to the entire PCON controller series.

To support these new features, the communication protocol has been changed to the general Modbus (Modbus-compliant) mode. As a result, the existing PC software programs and teaching pendants compatible with RCP2 controllers can no longer be used.

If you are using this controller, use a compatible PC software program and/or teaching pendant selected from the following models.

	Model	Versions to be supported	Remarks
PC software	RCM-101-***	V6.0.0.0	All are compatible with existing RCP2 controllers
Teaching pendant	RCM-T	V2.00	
Simple teaching pendant	RCM-E	V2.00	
Data setting unit	RCM-P	V2.00	

### 4. Recommendation for Backing up Latest Data

This product uses nonvolatile memory to store the position table and parameters. Normally the memory will retain the stored data even after the power is disconnected. However, the data may be lost if the nonvolatile memory becomes faulty.

(We strongly recommend that the latest position table and parameter data be backed up so that the data can be restored quickly in the event of power failure, or when the controller must be replaced for a given reason.)

The data can be backed up using the following methods:

- [1] Save to a CD or FD from the PC software.
- [2] Hand write the position table and parameter table on paper.

## 5. Initial Parameter Settings at Startup

After applying power, at least the three parameters specified below must be set in accordance with the specific application.

Inappropriate settings of these parameters will prevent the controller from operating properly, so exercise due caution.

For details on how to set the parameters, refer to "Parameter Settings" in the operation manual for the PC or teaching pendant.

### [1] Selecting the PIO pattern

This controller provides six PIO pattern types to meet the needs of various applications.

To select a desired type, set a corresponding value from 0 to 5 in parameter No. 25 (PIO pattern selection).

The factory setting is "0 [Standard type]."

Parameter No. 25 setting	Feature of PIO pattern
0	<p>Standard type</p> <p>A basic type supporting 64 positioning points and two zone outputs.</p> <p>* How to set zone boundaries within which to output a zone signal: Zone boundaries are set using parameter Nos. 1 and 2 for one zone output, and in the position table for another zone output.</p>
1	<p>Teaching type</p> <p>In this type, 64 positioning points and one zone output (boundaries are set in the position table) are supported.</p> <p>In addition to the normal positioning mode, the user can also select the teaching mode in which the actuator can be jogged via commands from a PLC and the current actuator position can be written to a specified position.</p> <p>(Note 1) Jog commands from a PLC are also accepted in the positioning mode.</p> <p>(Note 2) Positions can be rewritten by approximately 100,000 times.</p>
2	<p>256-point positioning type</p> <p>The number of positioning points is increased to 256, so only one zone output is available (boundaries are set in the position table).</p>
3	<p>512-point positioning type</p> <p>The number of positioning points is increased to 512, so no zone output is available.</p>
4	<p>7-point type</p> <p>The number of positioning points is limited to seven to offer separate direct command inputs and position complete outputs for respective positions.</p> <p>PLC ladder sequence circuits can be designed easily.</p>
5	<p>3-point type</p> <p>Use of the controller as an air cylinder is assumed in this type.</p> <p>Position complete output signals function differently in this type, compared to the 7-point type.</p> <p>Specifically, the signal functions not only to "indicate position complete," but also to "detect a position" in the same manner as auto-switches of an air cylinder.</p>

[2] Enabling/disabling the servo ON input signal (SON)

The servo ON input signal has been added to allow for servo ON/OFF control on the PLC side. Depending on the needs, therefore, the user must enable/disable this signal.

To select a desired setting, set "0" or "1" in parameter No. 21 (Servo ON input disable selection).

	Setting
Enable (use)	0
Disable (do not use)	1

The factory setting is "0 [Enable]."

[3] Enabling/disabling the pause signal (\*STP)

The pause signal uses the contact b logic to provide a failsafe function.

Therefore, this signal must remain ON in normal conditions of use.

Since there are applications where this signal is not used, a parameter is provided to disable the pause signal so it doesn't have to be turned ON.

To select a desired setting, set "0" or "1" in parameter No. 15 (Pause input disable selection).

	Setting
Enable (use)	0
Disable (do not use)	1





The factory setting is "0 [Enable]."



Air-Oil Systems, Inc. www.airoil.com

## Safety Precautions (Please read before using the product.)

Before installing, operating, maintaining or inspecting this product, please peruse this operating manual as well as the operating manuals and other related documentations for all equipment and peripheral devices connected to this product in order to ensure the correct use of this product and connected equipment/devices. Those performing installation, operation, maintenance and inspection of the product must have sufficient knowledge of the relevant equipment and their safety. The precautions provided below are designed to help you use the product safely and avoid bodily injury and/or property damage.

In this operating manual, safety precautions are classified as “Danger,” “Warning,” “Caution” and “Note,” according to the degree of risk.

 <b>Danger</b>	Failure to observe the instruction will result in an imminent danger leading to death or serious injury.
 <b>Warning</b>	Failure to observe the instruction may result in death or serious injury.
 <b>Caution</b>	Failure to observe the instruction may result in injury or property damage.
 <b>Note</b>	The user should take heed of this information to ensure the proper use of the product, although failure to do so will not result in injury.

It should be noted that the instructions under the  **Caution** and  **Note** headings may also lead to serious consequences, if unheeded, depending on the situation.

All instructions contained herein provide vital information for ensuring safety. Please read the contents carefully and handle the product with due caution.

Please keep this operating manual in a convenient place for quick reference whenever needed, and also make sure that the manual will get to the end-user.



### **Danger**

[General]

● Do not use this product for the following applications:

1. Medical equipment used to maintain, control or otherwise affect human life or physical health
2. Mechanisms and machinery designed for the purpose of moving or transporting people
3. Important safety parts of machinery

This product has not been planned or designed for applications requiring high levels of safety. Use of this product in such applications may jeopardize the safety of human life. The warranty covers only the product as it is delivered.

## [Installation]

- Do not use this product in a place exposed to ignitable, inflammable or explosive substances. The product may ignite, burn or explode.
- Avoid using the product in a place where the main unit or controller may come in contact with water or oil droplets.
- Never cut and/or reconnect the cables supplied with the product for the purpose of extending or shortening the cable length. Doing so may result in fire.

## [Operation]

- Do not allow the product to come in contact with water. If the product contacts water or is washed with water, it may operate abnormally and cause injury, electric shock, fire, etc.

## [Maintenance, Inspection, Repair]

- Never modify the product. Unauthorized modification may cause the product to malfunction, resulting in injury, electric shock, fire, etc.
- Do not disassemble and reassemble the product. Doing so may result in injury, electric shock, fire, etc.



## Warning

## [General]

- Do not use the product outside the specifications. Using the product outside the specifications may cause it to fail, stop functioning or sustain damage. It may also significantly reduce the service life of the product. In particular, observe the maximum loading capacity and speed.

## [Installation]

- If the machine will stop in the case of system problem such as emergency stop or power failure, design a safety circuit or other device that will prevent equipment damage or injury.
- Be sure to provide Class D grounding for the controller and actuator (formerly Class 3 grounding: Grounding resistance at 100  $\Omega$  or less). Leakage current may cause electric shock or malfunction.
- Before supplying power to and operating the product, always check the operation area of the equipment to ensure safety. Supplying power to the product carelessly may cause electric shock or injury due to contact with the moving parts.
- Wire the product correctly by referring to the operation manual. Securely connect the cables and connectors so that they will not be disconnected or come loose. Failure to do so may cause the product to malfunction or cause fire.

## [Operation]

- Do not touch the terminal block or various switches while the power is supplied to the product. Failure to observe this instruction may result in electric shock or malfunction.
- Before operating the moving parts of the product by hand (for the purpose of manual positioning, etc.), confirm that the servo is turned off (using the teaching pendant). Failure to observe this instruction may result in injury.
- Do not scratch the cables. Scratching, forcibly bending, pulling, winding, crushing with heavy object or pinching a cable may cause it to leak current or lose continuity, resulting in fire, electric shock, malfunction, etc.

- If the product is generating heat, smoke or a strange smell, turn off the power immediately. Continuing to use the product may result in product damage or fire.
- If any of the internal protective devices (alarms) of the product has actuated, turn off the power immediately. Continuing to use the product may result in product damage or injury due to malfunction. Once the power supply is cut off, investigate and remove the cause and then turn on the power again.
- If the LEDs on the product do not illuminate after turning on the power, turn off the power immediately. The protective device (fuse, etc.) on the live side may remain active. Request repair to the IAI sales office from which you purchased the product.

#### [Maintenance, Inspection, Repair]

- Before conducting maintenance/inspection, parts replacement or other operations on the product, completely shut down the power supply. At this time, take the following measures:
  1. Display a sign that reads, "WORK IN PROGRESS. DO NOT TURN ON POWER" at a conspicuous place, in order to prevent a person other than the operator from accidentally turning on the power.
  2. When two or more operators are to perform maintenance/inspection together, always call out every time the power is turned on/off or an axis is moved in order to ensure safety.

#### [Disposal]

- Do not throw the product into fire. The product may burst or generate toxic gases.



### Caution

#### [Installation]

- Do not use the product under direct sunlight (UV ray), in a place exposed to dust, salt or iron powder, in a humid place, or in an atmosphere of organic solvent, phosphate-ester machine oil, etc. The product may lose its function over a short period of time, or exhibit a sudden drop in performance or its service life may be significantly reduced. The product may also malfunction.
- Do not use the product in an atmosphere of corrosive gases (sulfuric acid or hydrochloric acid), etc. Rust may form and reduce the structural strength.
- When using the product in any of the places specified below, provide a sufficient shield. Failure to do so may result in malfunction:
  1. Place where large current or high magnetic field is present
  2. Place where welding or other operations are performed that cause arc discharge
  3. Place subject to electrostatic noise
  4. Place with potential exposure to radiation
- Do not install the product in a place subject to large vibration or impact. Doing so may result in the malfunctioning of the product.
- Provide an emergency-stop device in a readily accessible position so the device can be actuated immediately upon occurrence of a dangerous situation during operation. Lack of such device in an appropriate position may result in injury.
- Provide sufficient maintenance space when installing the product. Routine inspection and maintenance cannot be performed without sufficient space, which will eventually cause the equipment to stop or the product to sustain damage.
- Always use IAI's genuine cables for connection between the controller and the actuator. Also use IAI's genuine products for the key component units such as the actuator, controller and teaching pendant.

- Before installing or adjusting the product or performing other operations on the product, display a sign that reads, "WORK IN PROGRESS. DO NOT TURN ON POWER." If the power is turned on inadvertently, injury may result due to electric shock or sudden activation of an actuator.

#### [Operation]

- Turn on the power to individual equipment one by one, starting from the equipment at the highest level in the system hierarchy. Failure to do so may cause the product to start suddenly, resulting in injury or product damage.
- Do not insert a finger or object in the openings in the product. It may cause fire, electric shock or injury.

#### [Maintenance, Inspection, Repair]

- Do not touch the terminals when performing an insulation resistance test. Electric shock may result. (Do not perform any withstand voltage test, since the product uses DC voltage.)



#### Note

#### [Installation]

- Do not place objects around the controller that will block airflows. Insufficient ventilation may damage the controller.
- Do not configure a control circuit that will cause the load to drop in case of power failure. Configure a control circuit that will prevent the table or load from dropping when the power to the machine is cut off or an emergency stop is actuated.

#### [Installation, Operation, Maintenance]

- When handling the product, wear protective gloves, protective goggles, safety shoes or other necessary gear to ensure safety.

#### [Disposal]

- When the product becomes no longer usable or necessary, dispose of it properly as an industrial waste.

#### Others

- IAI shall not be liable whatsoever for any loss or damage arising from a failure to observe the items specified in "Safety Precautions."



## Table of Contents

1. Overview .....	1
1.1 Introduction .....	1
1.2 How to Read the Model Specification .....	2
1.3 System Configuration .....	3
1.3.1 Internal Drive-Power Cutoff Relay Type (PCON-C/CF) .....	3
1.3.2 External Drive-Power Cutoff Relay Type (PCON-CG) .....	4
1.4 Procedure from Unpacking to Test Operation and Adjustment .....	5
1.5 Warranty Period and Scope of Warranty .....	7
2. Specifications .....	8
2.1 Basic Specifications .....	8
2.2 Name and Function of Each Part of the Controller .....	9
2.3 External Dimensions .....	11
3. Installation and Noise Elimination .....	12
3.1 Installation Environment .....	12
3.2 Power Supply .....	12
3.3 Noise Elimination and Grounding .....	12
3.4 Heat Radiation and Installation .....	14
4. Wiring .....	15
4.1 Internal Drive-Power Cutoff Relay Type (PCON-C/CF) .....	15
4.1.1 External Connection Diagram .....	15
4.1.2 Wiring the Power Supply/Emergency-Stop Switch .....	16
4.2 External Drive-Power Cutoff Relay Type (PCON-CG) .....	23
4.2.1 External Connection Diagram .....	23
4.2.2 Wiring the Power Supply/Emergency-Stop Switch .....	24
4.3 Connecting the I/O Cables .....	27
• PIO pattern 0 [Standard Type] .....	27
• PIO pattern 1 [Teaching Type] .....	28
• PIO pattern 2 [256-piont mode] .....	29
• PIO pattern 3 [512-piont mode] .....	30
• PIO pattern 4 [Solenoid valve mode 1] .....	31
• PIO pattern 5 [Solenoid valve mode 2] .....	32
4.4 Connecting the Actuator .....	34
4.4.1 Motor Relay Cable .....	34
4.4.2 Encoder Relay Cable .....	35
4.4.3 Encoder Relay Cable [Large-capacity 6-A Type Controller] .....	36
4.5 Connecting the Communication Cable .....	37

5.	I/O Signal Control and Signal Functions.....	38
5.1	Interface Circuit .....	38
5.1.1	External Input Specifications.....	38
5.1.2	External Output Specifications.....	39
5.2	PIO Patterns and Signal Assignments .....	40
5.2.1	Explanation of Signal Names.....	41
	• PIO pattern = 0: Positioning mode [Standard type].....	41
	• PIO pattern = 1: Teaching mode [Teaching type] .....	42
	• PIO pattern = 2: 256-point mode [256-point type].....	43
	• PIO pattern = 3: 512-point mode [512-point type].....	44
	• PIO pattern = 4: Solenoid valve mode 1 [7- point type] .....	45
	• PIO pattern = 5 Solenoid valve mode 2 [3-point type] .....	46
5.2.2	Signal Assignment Table for Respective PIO Patterns .....	47
5.3	Details of I/O Signal Functions .....	48
5.3.1.	Details of Each Input Signal.....	48
	• Operating mode (RMOD) .....	48
	• Start (CSTR) .....	48
	• Command position number (PC1 to PC256).....	48
	• Pause (*STP).....	49
	• Home return (HOME) .....	49
	• Servo ON (SON).....	49
	• Alarm reset (RES) .....	49
	• Brake release (BKRL) .....	50
	• Operation mode (MODE) .....	50
	• Current-position write (PWRT) .....	50
	• Manual operation switching (JISL) .....	50
	• Jog (JOG+, JOG-) .....	51
	• Direct position command (ST0 to ST6) [7-point type] .....	51
	• Movement to each position (ST0 to ST2) [3-point type].....	52
5.3.2	Details of Each Output Signal.....	53
	• Operating mode status (RMDS).....	53
	• Completed position number (PM1 to PM256).....	53
	• Moving (MOVE).....	53
	• Position complete (PEND).....	53
	• Home return completion (HEND) .....	54
	• Zone (ZONE1, ZONE2).....	54
	• Current operation mode (MODES).....	54
	• Write completion (WEND) .....	54
	• Movement complete at each position (PE0 to PE6) [7-point type].....	55
	• Position detection output at each position (LS0 to LS2) [3-point type] .....	55
	• Ready (SV) .....	55
	• Alarm (*ALM).....	55
	• Emergency stop (*EMGS).....	56
	• Load output judgment status (LOAD) .....	56

• Torque level status (TRQS) .....	56
• Output Signal Changes in Each Mode .....	56
<b>6. Data Entry &lt;Basics&gt;</b> .....	<b>57</b>
6.1 Description of Position Table .....	57
6.1.1 Relationship of Push Force at Standstill and Current-Limiting Value .....	61
• Slider type .....	61
(1) SA5C/SA6C/SS7C type .....	61
(2) SA7C type .....	61
(3) SS8C type .....	62
• Rod type .....	63
(1) RA2C type .....	63
(2) RA3C type .....	63
(3) RA4C type .....	64
(4) RA6C type .....	64
(5) RA10C/W-RA10C type .....	65
6.2 Explanation of Modes .....	66
6.2.1 Positioning Mode Push = 0 .....	66
6.2.2 Push & Hold Mode Push = Other than 0 .....	66
6.2.3 Torque Check Function in Push & Hold Operation .....	68
6.2.4 Speed Change during Movement .....	70
6.2.5 Operation at Different Acceleration and Deceleration Settings .....	70
6.2.6 Pause .....	71
6.2.7 Zone Signal Output .....	71
6.2.8 Home Return .....	72
6.2.9 Overview of Teaching Type .....	73
6.2.10 Overview of 7-point Type .....	74
6.2.11 Overview of 3-point Type .....	76
6.3 Notes on the ROBO Gripper .....	78
6.4 Power-saving Modes at Standby Positions .....	80
<b>7. Operation &lt;Practical Steps&gt;</b> .....	<b>83</b>
7.1 How to Start .....	83
7.1.1 Timings after Power On .....	83
■ Procedure after initial startup until actuator adjustment .....	83
■ Procedure of Normal Operation .....	85
7.1.2 Position Table and Parameter Settings Required for Operation .....	88
■ Startup adjustment .....	88
• Safety speed during manual feed .....	88
• Speed override for movement commands from the PLC .....	88
■ Full-scale operation .....	89
• Saving energy when the actuator stands by for a long time after the power has been turned on .....	89
• Saving energy when the actuator stands by after completing the home return operation effected by the HOME input signal .....	89
• Saving energy when the actuator stands by for a long time at the target position ....	89
• Output mode of complete signal .....	89

# P CON

---

---

7.2	Home Return Operation .....	90
7.2.1	Method Using the HOME Input Signal (PIO Pattern = 0 to 4).....	90
7.2.2	Method Used When No HOME Input Signal Is Available (PIO Pattern = 5).....	92
7.3	Positioning Mode (Back and Forth Movement between Two Points).....	93
7.4	Push & Hold Mode.....	95
7.4.1	Return Action after Push & Hold by Relative Coordinate Specification .....	97
7.5	Speed Change during Movement.....	98
7.6	Operation at Different Acceleration and Deceleration Settings .....	100
7.7	Pause.....	102
7.8	Zone Signal Output.....	104
7.9	Incremental Moves .....	107
7.9.1	Judgment Method of End Position.....	109
7.9.2	Notes on Incremental Mode.....	110
7.10	Jogging/Teaching Using PIO .....	113
7.11	Operation in 7-point Type .....	115
7.12	Operation in 3-point Type .....	119
8.	Parameters.....	123
8.1	Parameter Table .....	123
8.2	Detail Explanation of Parameters.....	125
8.2.1	Parameters Relating to the Actuator Stroke Range .....	125
	● Soft limit (No.3/4 LIMM/LIML).....	125
	● Zone boundary (1: No.1/2 ZONM/ZONL 2: No.23/24 ZNM2/ZNL2).....	125
	● Home return direction (No.5 ORG).....	126
	● Home return offset (No.22 OFST) .....	126
8.2.2	Parameters Relating to the Actuator Operating Characteristics.....	126
	● PIO jog speed (No.26 IOJV).....	126
	● PIO inching distance (No.48 IOID) .....	126
	● Default speed (No.8 VCMD).....	126
	● Default acceleration/deceleration (No.9 ACMD) .....	127
	● Default positioning band (in-position) (No.10 INP).....	127
	● Current-limiting value at standstill during positioning (No.12 SPOW).....	127
	● Current-limiting value during home return (No.13 ODPW).....	127
	● Home sensor input polarity (No. 18, LS) .....	127
	● Speed override (No.46 OVRD).....	127
	● Default direction of excited-phase signal detection (No.28 PHSP).....	128
	● Excited-phase signal detection time (No.29 PHSP).....	128
	● Safety speed (No.35 SAFV) .....	128
	● Automatic servo-off delay time (No.36 ASO1/No.37 ASO2/No.38 ASO3).....	129
	● Default standstill mode (No.35 CTLF).....	129
	● Push speed (No.34 PSHV).....	130
	● Push completion judgment time (No.6 PSWT).....	130
	● Enable function (No.42 FDIO4).....	131
	● Polarity of home check sensor input (No.43 AIOF).....	131
	● Load output judgment time (No.50 LDWT).....	131
	● Torque check range (No.51 TRQZ).....	132
	● Ball screw lead length (No.77 LEAD).....	132
	● Axis operation type (No.78 ATYP) .....	132
	● Rotational axis mode selection (No.79 ATYP) .....	132

# P CON

---

---

●	Shortcut selection for rotational axis (No.80 ATYP).....	132
●	Absolute unit (No.83 ETYP) .....	133
8.2.3	Parameters Relating to the External Interface .....	134
●	PIO pattern selection (No.25 IOPN).....	134
●	Movement command type (No.27 FPIO).....	135
●	Pause input disable selection (No.15 FPIO) .....	136
●	Servo ON input disable selection (No.21 FPIO).....	136
●	Home-return input disable selection (No.40 FPIO) .....	136
●	Operating-mode input disable selection (No.41 FPIO) .....	136
●	Output mode of position complete signal (No.39 FPIO).....	137
●	SIO communication speed (No.16 BRSL).....	137
●	Minimum delay time for slave transmitter activation (No.17 RTIM).....	137
●	Silent interval multiplier (No.45 SIVM).....	138
8.2.4	Servo Gain Adjustment.....	139
●	Servo gain number (No.7 PLG0).....	139
●	Speed loop proportional gain (No.31 VLPG).....	139
●	Speed loop integral gain (No.32 VLPT).....	140
●	Torque filter time constant (No.33 TRQF).....	140
9.	PC/Teaching Pendant Connection Method in Multi-axis Configurations.....	141
9.1	Connection Example .....	141
9.2	Name and Function of Each Part of the SIO Converter .....	142
9.3	Address Switch.....	144
9.4	Connection Cables .....	144
9.5	Detail Connection Diagram.....	145
10.	Troubleshooting.....	146
10.1	Action to Be Taken upon Occurrence of Problem .....	146
10.2	Alarm Level Classification .....	147
10.3	Alarm Description Output Using PIO .....	148
10.4	Alarm Description and Cause/Action.....	149
(1)	Message level alarms.....	149
(2)	Cold-start level alarms.....	153
10.5	Messages Displayed during Operation Using the Teaching Pendant .....	156
10.6	Specific Problems .....	159
●	I/O signals cannot be exchanged with the PLC. ....	159
●	The ALM lamp illuminates when the power is input. ....	159
●	The SV lamp does not illuminate when the servo ON signal is input after the power was input. ....	159
●	Home return ends in the middle in a vertical application. ....	160
●	Noise occurs during downward movements in a vertical application.....	160
●	Vibration occurs when the actuator is stopped. ....	160
●	The actuator overshoots when decelerated to a stop. ....	160
●	The home and target positions sometimes shift.....	160
●	The speed is slow during push & hold operation. ....	160
●	The actuator moves only a half of, or twice as much as, the specified movement. ....	160
●	A servo error occurred while the actuator was moving (ROBO Gripper). ....	161
●	Abnormal operation results when the servo is turned ON after the power ON. ....	162
●	The SV lamp blinks. ....	162

# **PCON** \_\_\_\_\_

- \* Appendix ..... 163
  - List of Supported Actuator Specifications ..... 163
  - Example of Basic PCON Positioning Sequence..... 174
  - Recording of Parameters..... 177

Air-Oil Systems, Inc. [www.airoil.com](http://www.airoil.com)

**P CON** \_\_\_\_\_

Air-Oil Systems, Inc. [www.airoil.com](http://www.airoil.com)

**Air-Oil Systems, Inc. [www.airoil.com](http://www.airoil.com)**



## 1. Overview

### 1.1 Introduction

This product is a dedicated RCP2 actuator controller that provides the same functions of the RCP2 controller as well as a set of new functions designed to achieve greater convenience and safety. The product also provides a power-saving function in response to growing energy-saving needs. The key features and functions are listed below.

- More positioning points  
The standard type supports up to 64 points, while the extended types can handle up to 512 points. Availability of more positioning points is ideal for production lines where many types of products are produced in small volumes.
- Setting of zone output boundaries for each position in the position table  
Before, zone output boundaries were set by parameters and therefore fixed. To add flexibility, new fields have been added to the position table so that different boundaries can be set for each position. This feature is useful in preventing contact with surrounding equipment and reducing the tact time, among others.
- Separate acceleration/deceleration settings  
Acceleration and deceleration are now set in separate fields of the position table. Depending on the material or shape of the load, it is desirable to reduce shock and vibration when the actuator stops. Since acceleration and deceleration can be set differently, only the deceleration value can be reduced to make the deceleration curve more gradual.
- Limitation of feed speed in test operation and adjustment  
The feed speed to be used in test operation and adjustment can be limited for added safety.
- Power-saving measures  
In general, pulse motors consume more holding current in standstill state than AC servo motors. This product provides a power-saving means to support situations where the actuator must stand by for a long period.

When actually starting up your system or if you have encountered any problem, also refer to the operation manuals for the actuator, teaching pendant, PC software and other components used with the system, in addition to this manual.

<p>This manual does not cover all possible operations other than normal operations, or unexpected events such as complex signal changes resulting from use of critical timings. Accordingly, you should consider items not specifically explained in this manual as “prohibited.”</p>
---

- \* We have made every effort to ensure accuracy of the information provided in this manual. Should you find an error, however, or if you have any comment, please contact IAI.  
Keep this manual in a convenient place so it can be referenced readily when necessary.

## 1.2 How to Read the Model Specification

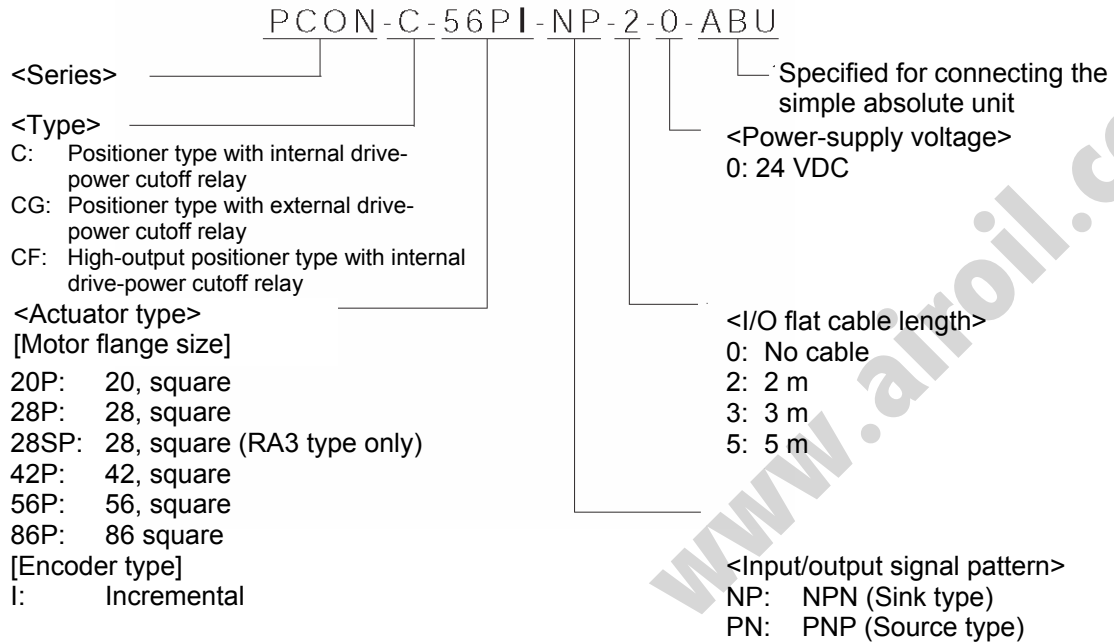

Air-Oil Systems, Inc. www.airoil.com

## 1.3 System Configuration

### 1.3.1 Internal Drive-Power Cutoff Relay Type (PCON-C/CF)

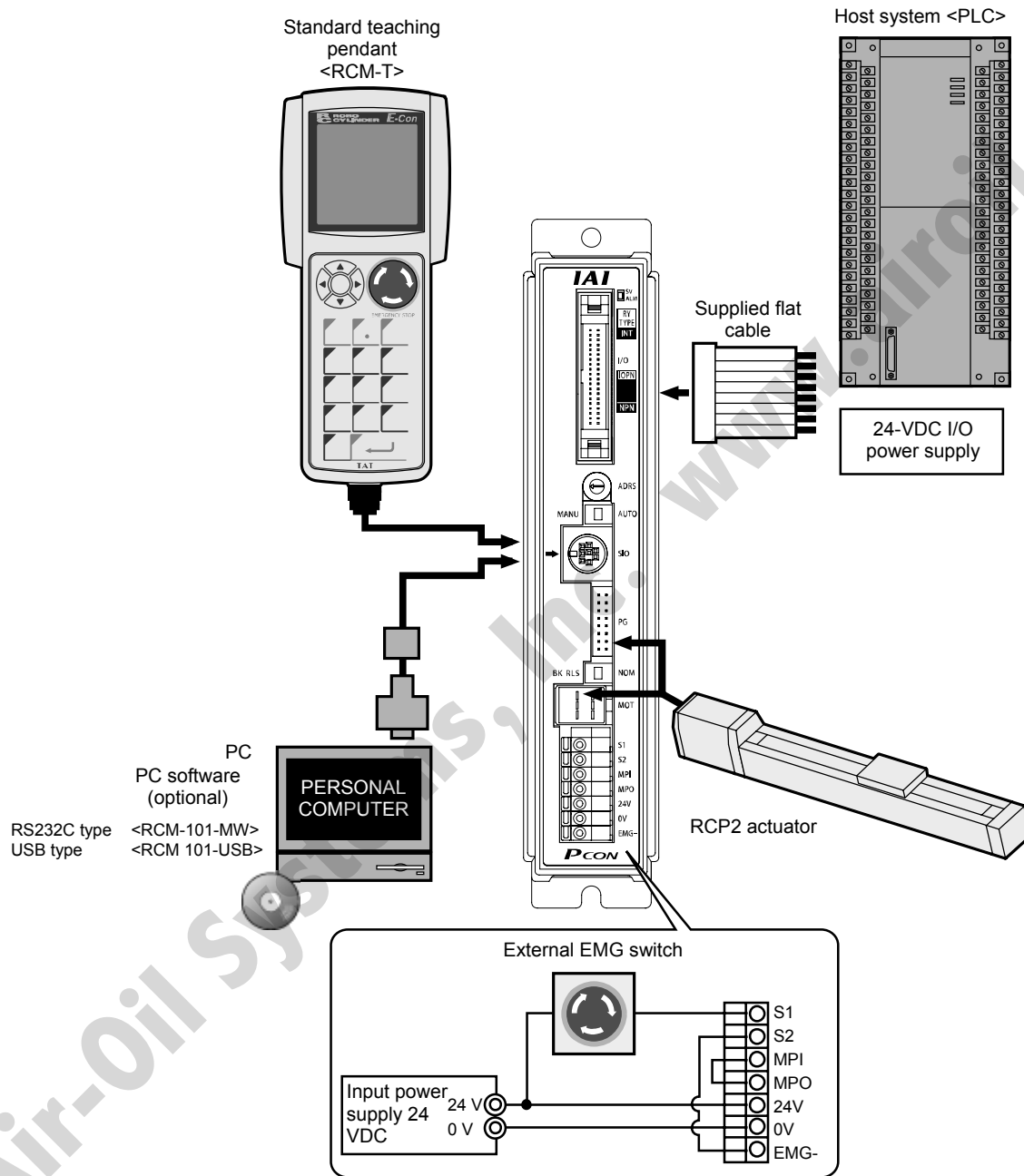

**Caution:** Connect one end of the EMG switch to the 24-V output of the input power supply and the other end to the S1 terminal. Also short the S2 and EMG terminals using a jumper wire.

# PCON

## 1.3.2 External Drive-Power Cutoff Relay Type (PCON-CG)

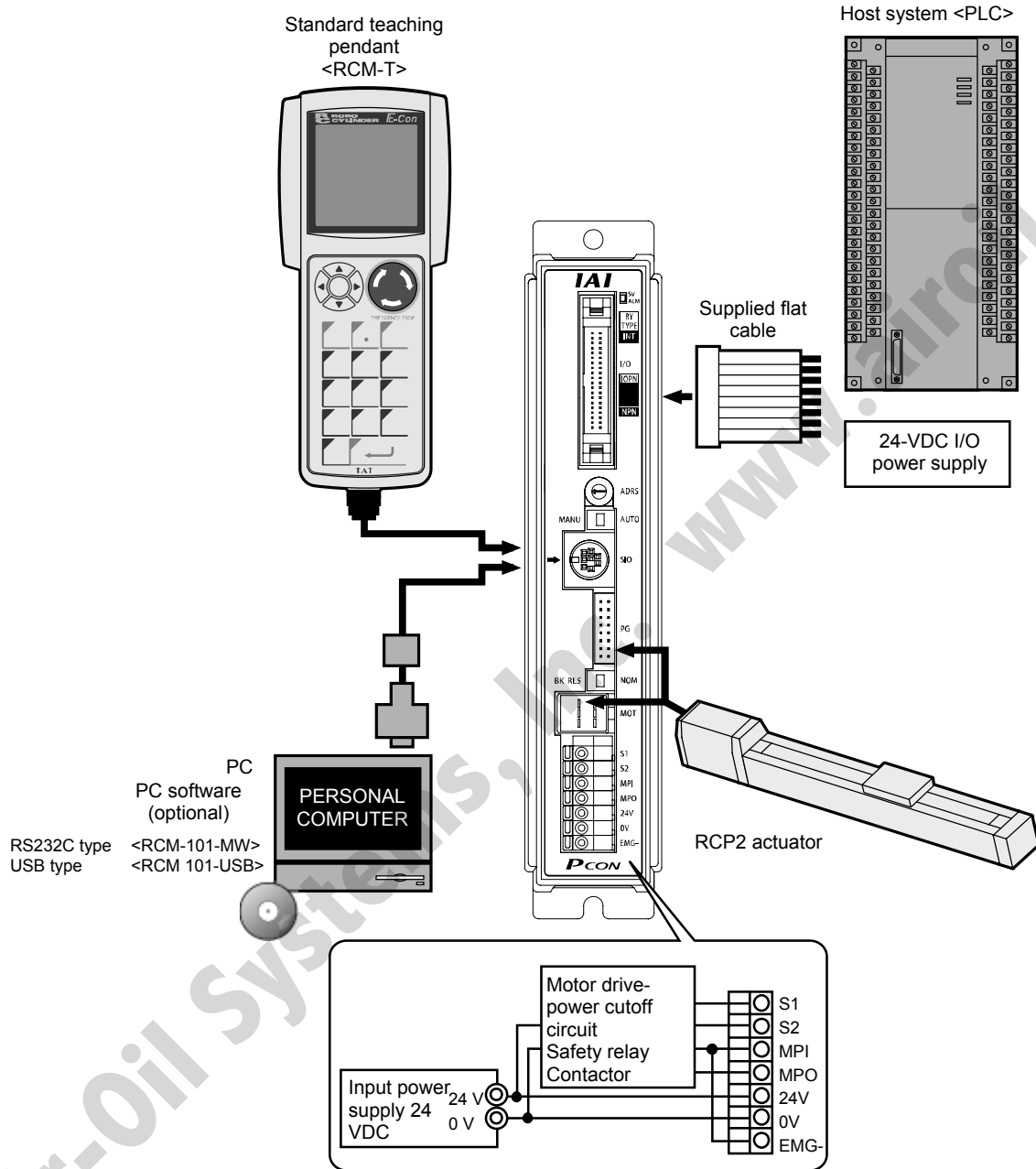

## 1.4 Procedure from Unpacking to Test Operation and Adjustment

If you are using this product for the first time, carry out each step by referring to the procedure below to ensure that all necessary items are checked and all wires are connected correctly.

### 1 Check the content in the package

If you found any missing part or part specified for a different model, please contact your dealer.

- Controller  
PCON-C  
PCON-CG  
PCON-CF
- Actuator
- I/O flat cable  
CB-PAC PIO\* \*\*
- Motor cable  
CB-RCP2-MA\* \*\*
- Encoder cable  
CB-RCP2-PA\* \*\*
- Operation manual

<Options>

- Teaching pendant  
RCM-T (standard)  
RCM-E (simple)  
RCM-P (data setting unit)
- PC software  
RC232C type <RCM-101-MW>  
RC232 type <RCM-101-USB>  
(Software comes with connection cables.)

### 2 Installation

- [1] Affix the actuator first, and then install the robot hand. → Refer to the operation manual for the applicable actuator.
- [2] Install the controller. → Chapter 3, "Installation"

### 3 Wiring/connection

- Wire the 24-V power supply.
- Connect the grounding wire to ground.
- Wire the emergency stop circuit and motor drive power supply.
- Connect the motor cable and encoder cable.
- Connect the I/O flat cable.

### 4 Turn on the power and check for alarms

Supply the 24-V power after confirming that the emergency stop circuit is not actuated.

If the monitor LED [SV/ALM] on the front face of the controller illuminates for two seconds and then turns off, the controller is functioning properly. If [SV/ALM] illuminates in red, it means an alarm has generated. Connect a PC or teaching pendant to check the nature of the alarm, and remove the cause by referring to Chapter 10, "Troubleshooting."

### 5 Set the PIO pattern/safety speed

Set the mode selector switch on the front face of the controller to the "MANU" side.

On the PC screen or teaching pendant, set the MANU operating mode to [Teaching mode: Enable safety speed/Inhibit PIOs].

In this condition, set appropriate values in parameter No. 25 (PIO pattern selection) and parameter No. 35 (Safety speed).

- \* The factory-set PIO pattern and safety speed are "standard type" and "100 mm/s or less," respectively.  
→ Chapter 8, "Parameter Settings"

## 6 Turn on the servo

Confirm that the slider or rod is not contacting a mechanical end.

If the slider/rod is contacting a mechanical end, move it away from the mechanical end.

If the actuator is equipped with a brake, turn on the brake forced-release switch to forcibly release the brake before moving the actuator.

The load may suddenly drop when the brake is released, so exercise due caution not to pinch your hand or damage the robot hand by the falling load.

Turn on the servo from the PC or teaching pendant.

If the actuator enters a servo lock mode and the monitor LED [SV/ALM] on the front face of the controller illuminates in green, the controller is functioning properly.

## 7 Check the operation of the safety circuit

Confirm that the emergency stop circuit (or motor drive-power cutoff circuit) operates properly.

→ Chapter 4, "Wiring"

## 8 Set a target position

Perform home return first, and then set a target position in the "Position" field for each position in the position table. Determine a desired position by finely adjusting the load or robot hand.

- \* Once a target position is set, all other fields (speed, acceleration/deceleration, positioning band, etc.) will be automatically populated with their default values. → Chapter 6, "Position Table Settings"
- \* To ensure safety, it is recommended that the safety speed be enabled during initial movements. To move the actuator at the actual speed set in the "Speed" field of the position table, change the MANU operating mode to [Teaching mode 2: Disable safety speed/Inhibit PIOs].

## 9 Trial operation and adjustment

Set the mode selector switch on the front panel of the controller to the "AUTO" side.

Input a movement command from the PLC to perform positioning.

If necessary, perform fine adjustments including the items specified below:

- Vibration or noise may generate depending on the weight, material or shape of the load. If vibration or noise is observed, lower the speed, acceleration and/or deceleration.
- To prevent contact with surrounding equipment or reduce the tact time, adjust the boundaries for each zone output signal and also adjust the positioning band.
- Adjust the current-limiting value, judgment time and push speed to be used in push & hold operation.

 **Caution:** Before changing any parameter, set the mode selector switch to the "MANU" side. Or, keep the mode selector switch on the "AUTO" side and turn on the MODE input signal.

## 1.5 Warranty Period and Scope of Warranty

The controller you have purchased passed IAI's shipping inspection implemented under the strictest standards. The unit is covered by the following warranty:

### 1. Warranty Period

The warranty period shall be one of the following periods, whichever ends first:

- 18 months after shipment from our factory
- 12 months after delivery to a specified location

### 2. Scope of Warranty

If an obvious manufacturing defect is found during the above period under an appropriate condition of use, IAI will repair the defect free of charge. Note, however, that the following items are excluded from the scope of warranty:

- Aging such as natural discoloration of coating
- Wear of a consumable part due to use
- Noise or other sensory deviation that doesn't affect the mechanical function
- Defect caused by inappropriate handling or use by the user
- Defect caused by inappropriate or erroneous maintenance/inspection
- Defect caused by use of a part other than IAI's genuine part
- Defect caused by an alteration or other change not approved by IAI or its agent
- Defect caused by an act of God, accident, fire, etc.

The warranty covers only the product as it has been delivered and shall not cover any losses arising in connection with the delivered product. The defective product must be brought to our factory for repair.

Please read carefully the above conditions of warranty.

## 2. Specifications

### 2.1 Basic Specifications

Specification item	Internal Drive-Power Cutoff Relay Type		External Drive-Power Cutoff Relay Type
	PCON-C	PCON-CF	PCON-CG
Model	PCON-C	PCON-CF	PCON-CG
Power-source capacity	2 A max.	6 A max.	2 A max.
Number of controlled axes	1 axis/unit		
Supply voltage	24 VDC +10% / -10%		
Control method	Weak field-magnet vector control		
Encoder resolution	800 P/rev		
Positioning command	Position number commands (64 points (standard), extendable up to 512 points), numerical specification		
Backup memory	Position number data and parameters are saved in nonvolatile memory. Serial EEPROM can be rewritten 100,000 times.		
PIO interface	24-VDC, insulated Dedicated 16 input points/16 output points		
LED indicators	SV (green) --- Servo on, ALM (red) --- Alarm present		
Serial communication	RS485, 1 channel (conforming to the Modbus protocol)		
Encoder interface	Incremental specification conforming to EIA RS-422A/423A		
Forced release of electromagnetic brake	Switch on the front face of the enclosure		
Cable length	Actuator cable: 20 m or less		
	I/O flat cable: 5 m or less		
Insulation strength	500 VDC, 10 MΩ		
Environment	Operating temperature	0 to 40°C	
	Operating humidity	85%RH or less (non-condensing)	
	Operating environment	Not subject to corrosive gases.	
	Storage temperature	-10 to 65°C	
	Storage humidity	90%RH or less (non-condensing)	
	Vibration resistance	10 to 57 Hz in XYZ directions / Pulsating amplitude: 0.035 mm (continuous), 0.075 mm (intermittent)	
Protection class	IP20		
Cooling	Automatic switching between natural cooling and forced air cooling at high temperature (CF type only)		
Weight	300 g or less	320 g or less	300 g or less
External dimensions	35 W x 175.5 H x 68.1 D mm		



## 2.2 Name and Function of Each Part of the Controller

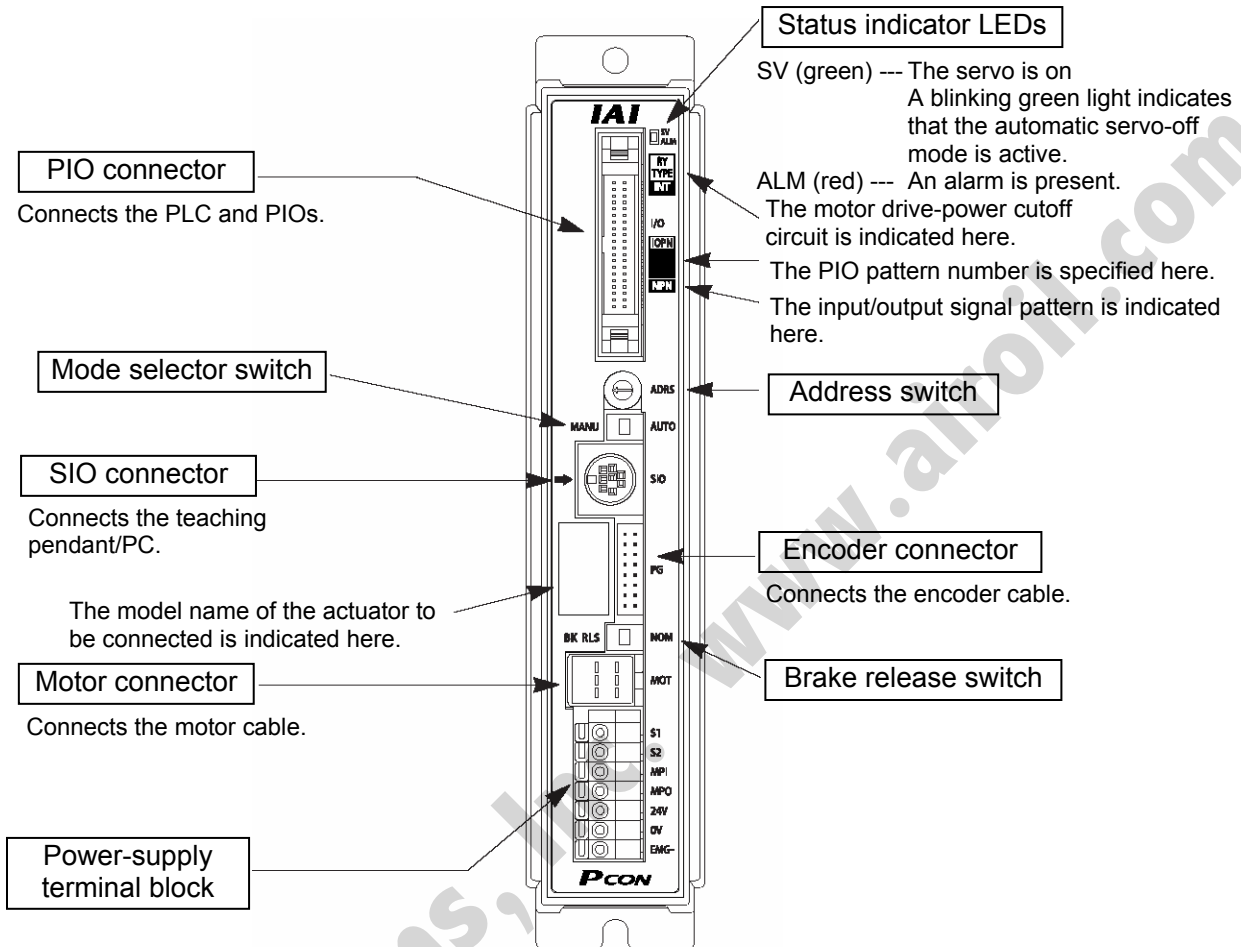

### ■ Indication of PIO pattern number

If you have multiple systems and a different PIO pattern is used for each system, it is recommended that you specify an applicable PIO pattern number on each controller to prevent confusion.

### ■ Explanation of input/output signal pattern

NPN --- Sink type  
PNP --- Source type

### ■ Explanation of motor drive-power cutoff circuit

INT --- PCON-C/CF [Internal drive-power cutoff relay type]  
EXT --- PCON-CG [External drive-power cutoff relay type]

### ■ Indication of model name of actuator to be connected

The type name, ball screw lead length and stroke of the applicable actuator are indicated. When connecting the cables, check this information to confirm that they are connected to the correct actuator.

Example of indication:

RA4C	← The actuator type is RA4C.
L: 5 mm	← The ball screw lead length is 5 mm.
ST: 200	← The stroke is 200 mm.

■ Explanation of each switch

[1] Address switch

If multiple axes are used, the PC/teaching pendant must be plugged into/out of different connectors to communicate with different axes.

To save the hassle, you can use link cables to connect all axes via SIO converters.

Under this method, however, the PC/teaching pendant must be able to identify each axis by the number assigned to the axis.

This switch is used to set this number.

For details, refer to Chapter 9, "How to Connect a PC/Teaching Pendant to Multiple Axes."

[2] Mode selector switch

This interlock switch is used to prevent unexpected movement or data rewrite as a result of duplicate operation in which a movement command is input from the PLC and operation using the PC/teaching pendant is performed at the same time.

AUTO: Always set to the "AUTO" side during auto operation using PIO signals from the PLC.

MANU: Always set to the "MANU" side during operation using the PC/teaching pendant.

[3] Brake release switch

When the actuator is equipped with a brake, this switch is used to forcibly release the brake.

RLS: Forcibly release the brake

NOR: Normal setting (The brake is released by the controller.)

△ Warning: The load may suddenly drop when the brake is forcibly released, so exercise due caution not to pinch your hand or damage the robot hand by the falling load.

■ Explanation of power-supply terminal block

[1] PCON-C/CF [Internal drive-power cutoff relay type]

S1, S2	Provide a contact output for the emergency-stop button on the teaching pendant. * Whether or not a teaching pendant is connected is determined by an internal circuit. If no teaching pendant is connected, the S1 and S2 terminals are closed.
MPI, MPO	Provide a contact for cutting off the motor drive power. MPI and MPO represent the input side and output side of the motor power supply, respectively. (Short these terminals using a jumper wire if not used. The controller is shipped with MPI and MPO shorted.)
24V	Positive side of the 24-VDC input power supply
0V	Negative side of the 24-VDC input power supply
EMG-	Emergency-stop input

[2] PCON-CG [External driver-power cutoff relay type]

S1, S2	Provide a contact output for the emergency-stop button on the teaching pendant. * Whether or not a teaching pendant is connected is determined by an internal circuit. If no teaching pendant is connected, the S1 and S2 terminals are closed.
MPI, MPO	Motor drive-power cutoff contacts conforming to safety category 1 MPI and MPO represent the input side and output side of the motor power supply, respectively. (Connect an external safety circuit.)
24V	Positive side of the 24-VDC input power supply
0V	Negative side of the 24-VDC input power supply
EMG-	Emergency stop signal detection

## 2.3 External Dimensions

An external view and dimensions of the product are shown below.

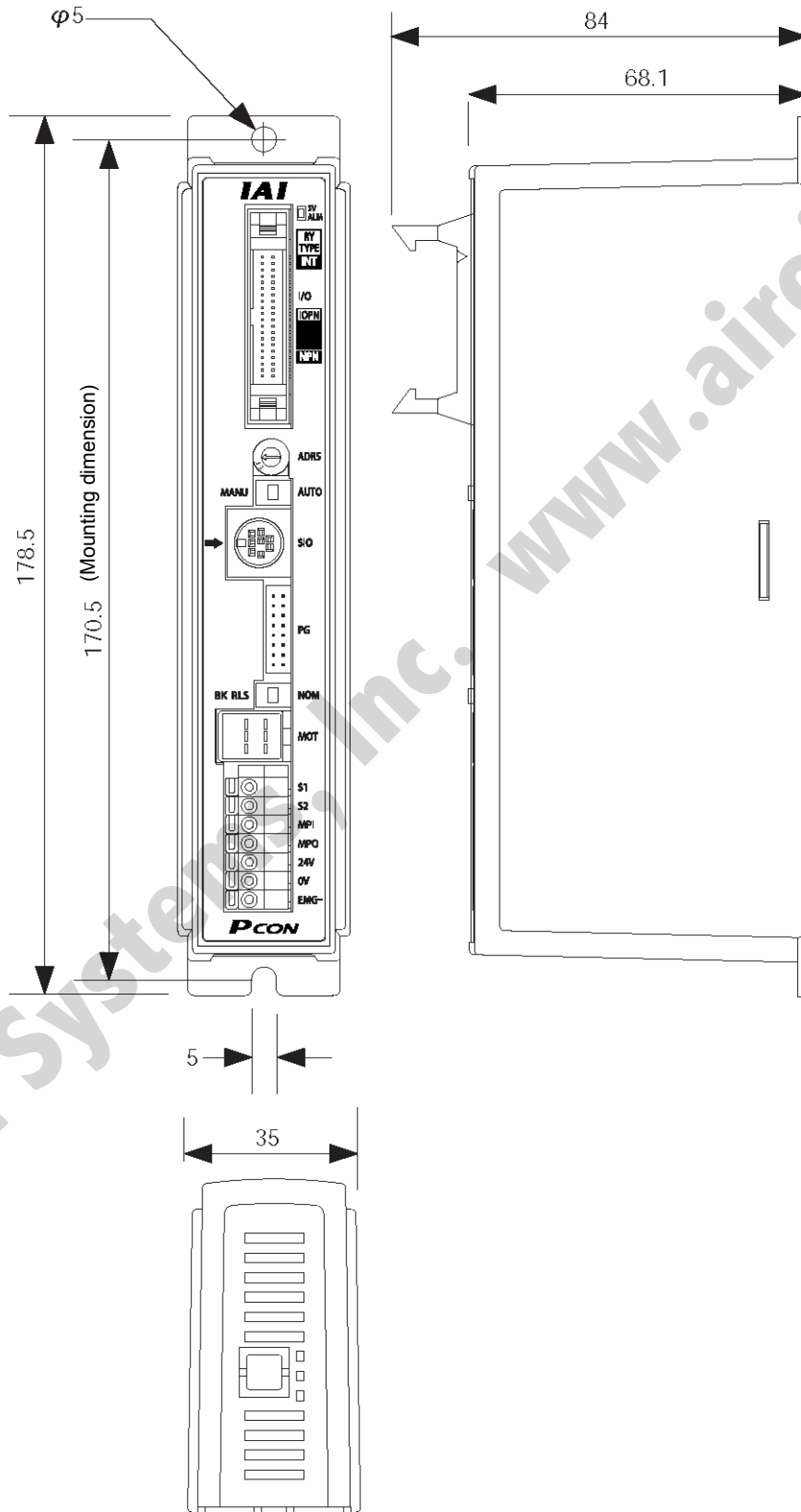

## 3. Installation and Noise Elimination

Pay due attention to the installation environment of the controller.

### 3.1 Installation Environment

- (1) When installing and wiring the controller, do not block the cooling ventilation holes. (Insufficient ventilation will not only prevent the controller from demonstrating its full performance, but it may also cause breakdown.)
- (2) Prevent foreign matter from entering the controller through the ventilation holes. Since the enclosure of the controller is not dustproof or waterproof (oilproof), avoid using the controller in a place subject to significant dust, oil mist or splashes of cutting fluid.
- (3) Do not expose the controller to direct sunlight or radiating heat from a large heat source such as a heat treatment furnace.
- (4) Use the controller in an environment free from corrosive or inflammable gases, under a temperature of 0 to 40°C and humidity of 85% or less (non-condensing).
- (5) Use the controller in an environment where it will not receive any external vibration or shock.
- (6) Prevent electrical noise from entering the controller or its cables.

### 3.2 Power Supply

The power supply specification is 24 VDC  $\pm$  10%.  
(Supply current: 2 A max.)

### 3.3 Noise Elimination and Grounding

This section explains how to eliminate noise in the use of the controller.

#### (1) Wiring and power supply

- [1] Provide a dedicated class D grounding using a wire with a size of 2.0 to 5.5 mm<sup>2</sup> or larger.

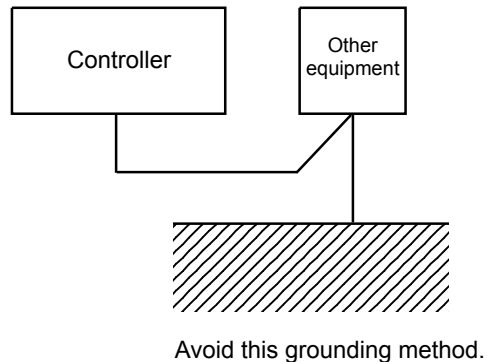
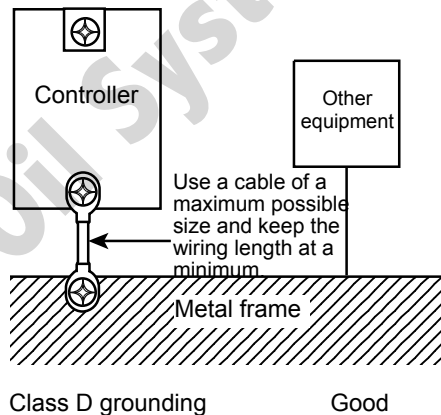

## [2] Precautions regarding wiring method

Use a twisted cable for connection to the 24-VDC external power supply.  
Separate the controller cables from high-power lines such as a cable connecting to a power circuit. (Do not bundle together the controller cables with high-power lines or place them in the same cable duct.)  
When extending the supplied motor cable or encoder cable, consult IAI's Technical Support.

## (2) Noise sources and elimination

Among the numerous noise sources, solenoid valves, magnet switches and relays are of particular concern when building a system. Noise from these sources can be eliminated by implementing the measures specified below.

### [1] AC solenoid valves, magnet switches and relays

Measure: Install a surge absorber in parallel with the coil.

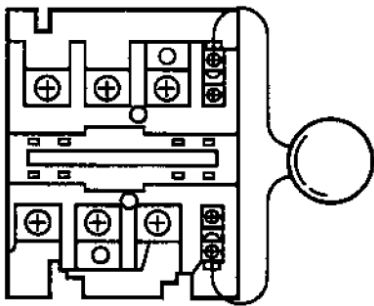

Point

Install a surge absorber to each coil over a minimum wiring length.

Installing a surge absorber to the terminal block or other part will be less effective because of a longer distance from the coil.

### [2] DC solenoid valves, magnet switches and relays

Measure: Install a diode in parallel with the coil. Determine the diode capacity in accordance with the load capacity.

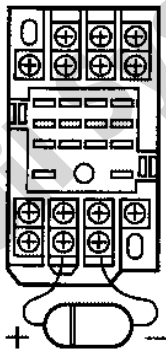

In a DC circuit, connecting a diode in reverse polarity will damage the diode, internal parts of the controller and/or DC power supply, so exercise due caution.

## 3.4 Heat Radiation and Installation

Design the control panel size, controller layout and cooling method in such a way that the temperature around the controller will not exceed 40°C.

Install the controller vertically on a wall, as shown below. Since cooling is provided by way of natural convection, always observe this installation direction and provide a minimum clearance of 50 mm above and below the controller to ensure sufficient natural airflows.

When installing multiple controllers side by side, providing a ventilation fan or fans above the controllers will help maintain a uniform temperature around the controllers.

Keep the front panel of the controller away from the wall (enclosure) by at least 95 mm.

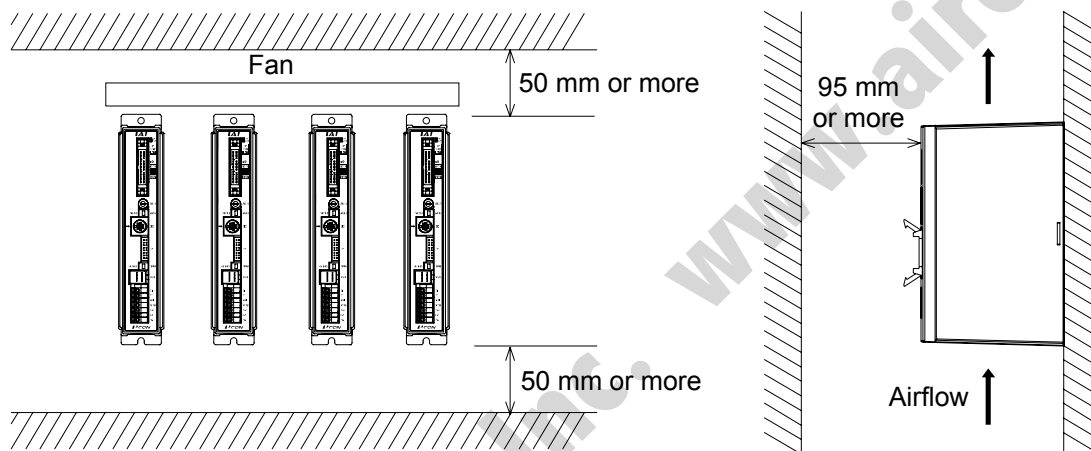

Regardless of whether your system consists of a single controller or multiple controllers, provide sufficient clearances around each controller so that it can be installed/removed easily.

## 4. Wiring

### 4.1 Internal Drive-Power Cutoff Relay Type (PCON-C/CF)

#### 4.1.1 External Connection Diagram

An example of standard wiring is shown below.

(Note) The encoder cable shown in the example is the standard cable for the controller with the maximum current of 2 A.

As for the robot cable or the cable for the dedicated controller for the high-thrust type, refer to 4.4.2, "Encoder Relay Cable."

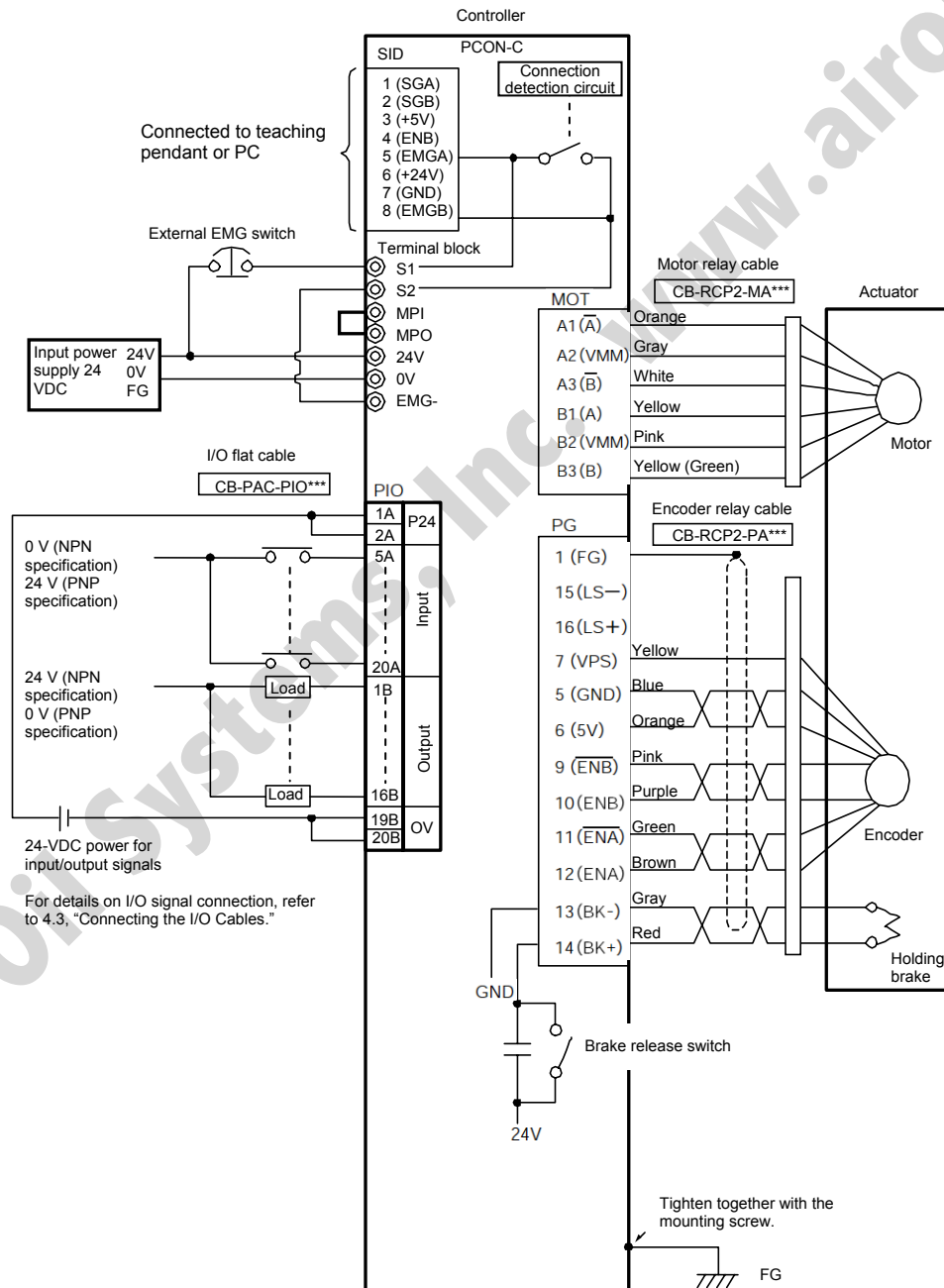

## 4.1.2 Wiring the Power Supply/Emergency-Stop Switch

### (1) Wiring the power supply

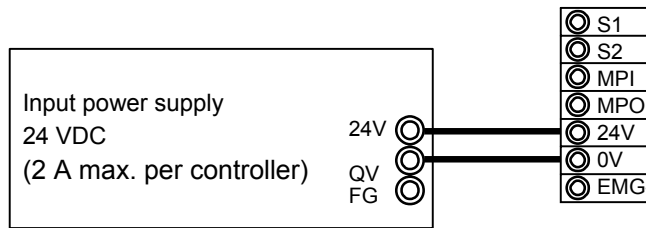

To connect multiple controllers, provide a relay terminal block.  
Use a power cable satisfying the following specifications:

Item	Specification
Applicable wire length	Single wire: $\varnothing 1.0$ / Stranded: $0.8 \text{ mm}^2$ , AWG size 18, (copper wire)
Stripped wire length	10 mm
Temperature rating of insulated sheath	$60^\circ\text{C}$ or above

\* Use a flathead screwdriver with a blade tip of approx. 2.6 mm to push in the wire.



## (2) Wiring the emergency-stop switch

In many cases multiple controllers are used in a single system.

To provide an emergency-stop function for the entire system, the controller circuit is designed in such a way that a single EMG switch is able to actuate an emergency stop in all connected controllers.

[Internal emergency-stop circuit]

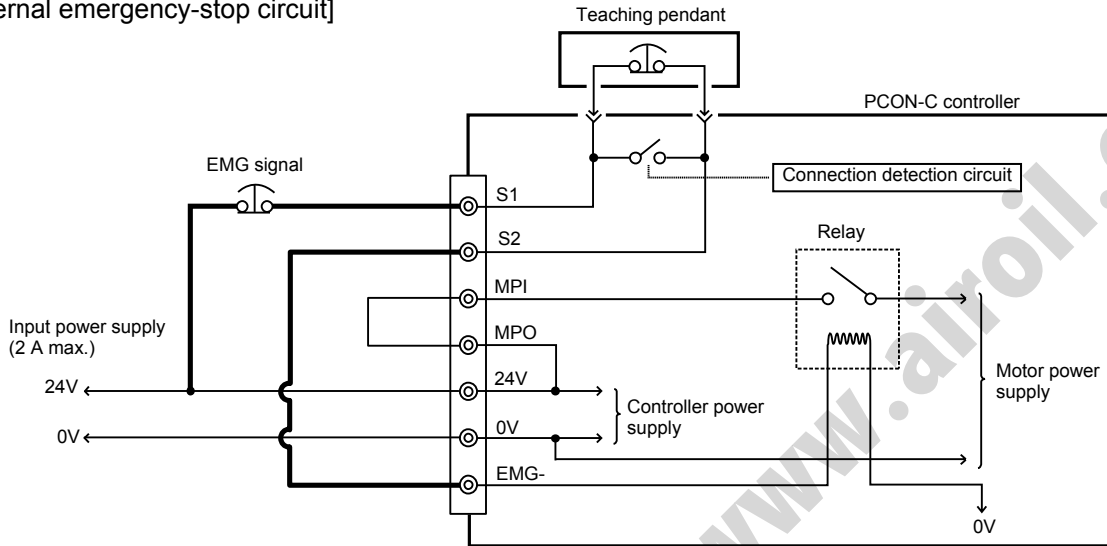

(Note) The current consumption of the internal relay is 10 mA or less.

(Reference)	Cutoff voltage	Cutoff current
EMG switch on teaching pendant	30 VDC	3 A

[Example of recommended circuit]

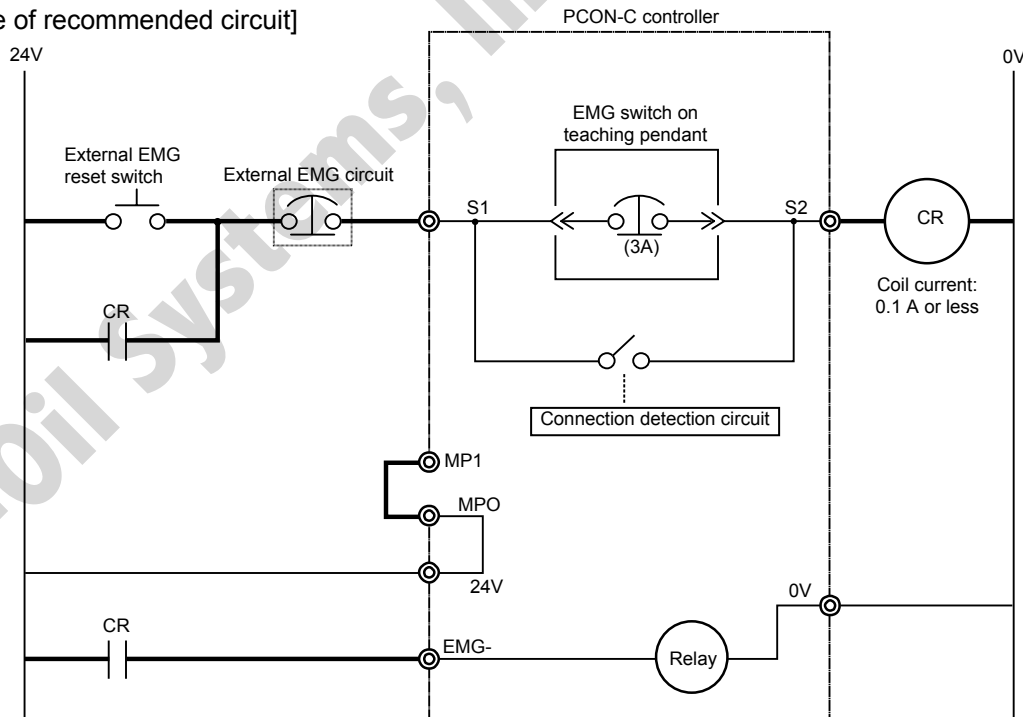

(Note) To cut off the motor drive power supply in conformance with safety category 2, connect 24V to the EMG terminal and a contactor or other contact device to the MPI/MPO terminals. (Refer to 4.2.3; rush current: 8 A.)

# P<sub>CON</sub>

---

---

Representative connection examples are explained below.

- Connecting the teaching pendant directly to the controller

[1] Connecting multiple controllers (8 units or less) using a single power supply

- Short the MPI and MPO terminals using a jumper wire. (The controller is shipped with these terminals shorted.)
- Connect one end of the EMG signal to the 24-V output of the input power supply and the other end to the S1 terminal.

Then, provide connections by sequentially connecting the S2 terminal of controller 1 to the S1 terminal of controller 2, the S2 terminal of controller 2 to the S1 terminal of controller 3, and so on, and connect the S2 terminal on the last controller to the EMG terminals on all controllers.

Use a relay terminal block for connection to the EMG terminals.

(Note) Do not connect two or more wires to one terminal.

Air-Oil Systems, Inc. [www.airoil.com](http://www.airoil.com)

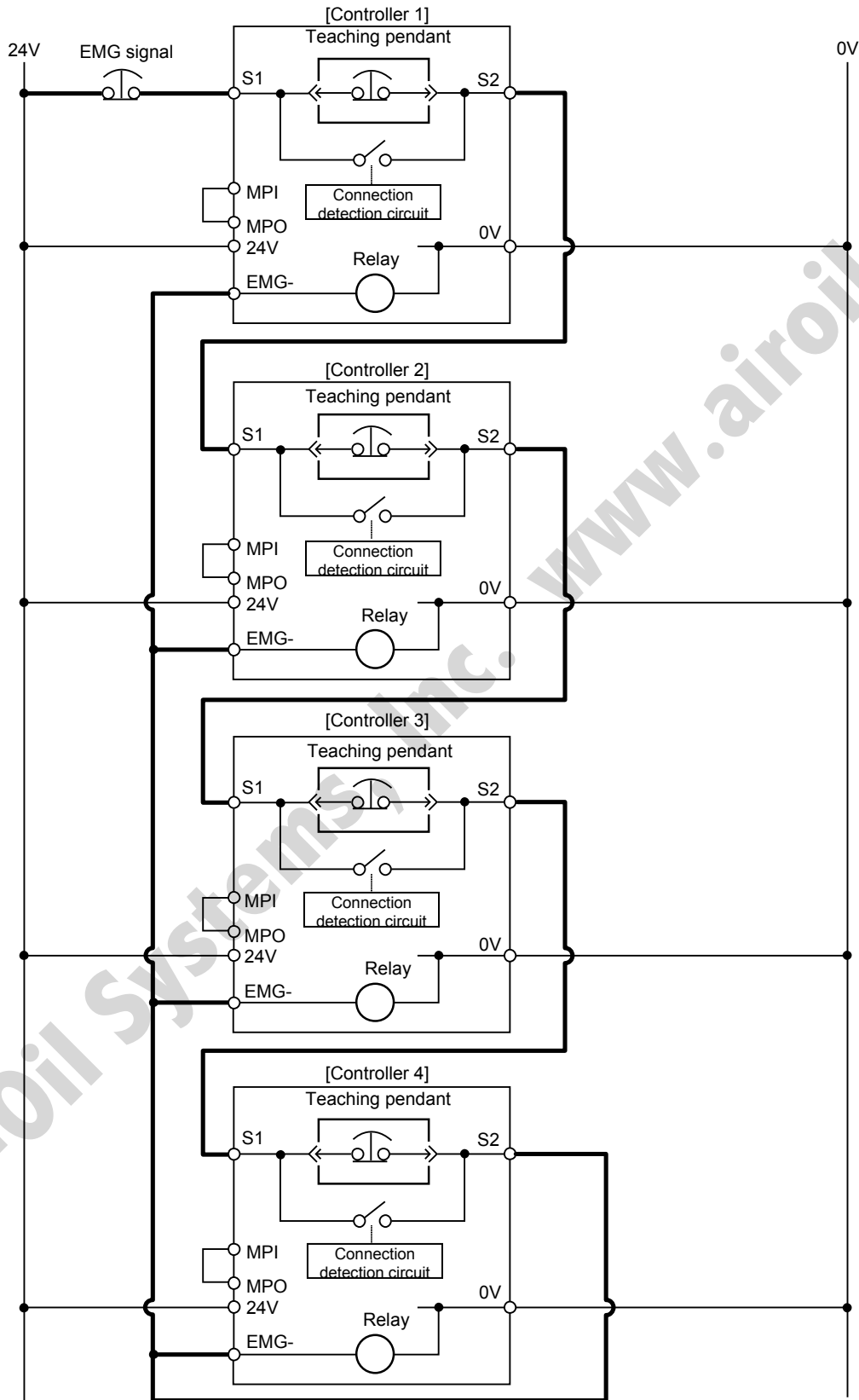

# P CON

[2] Using a power supply other than the input power supply

(Note) Use an auxiliary relay with a coil current of 0.1 A or less and connect a diode for coil surge absorption.

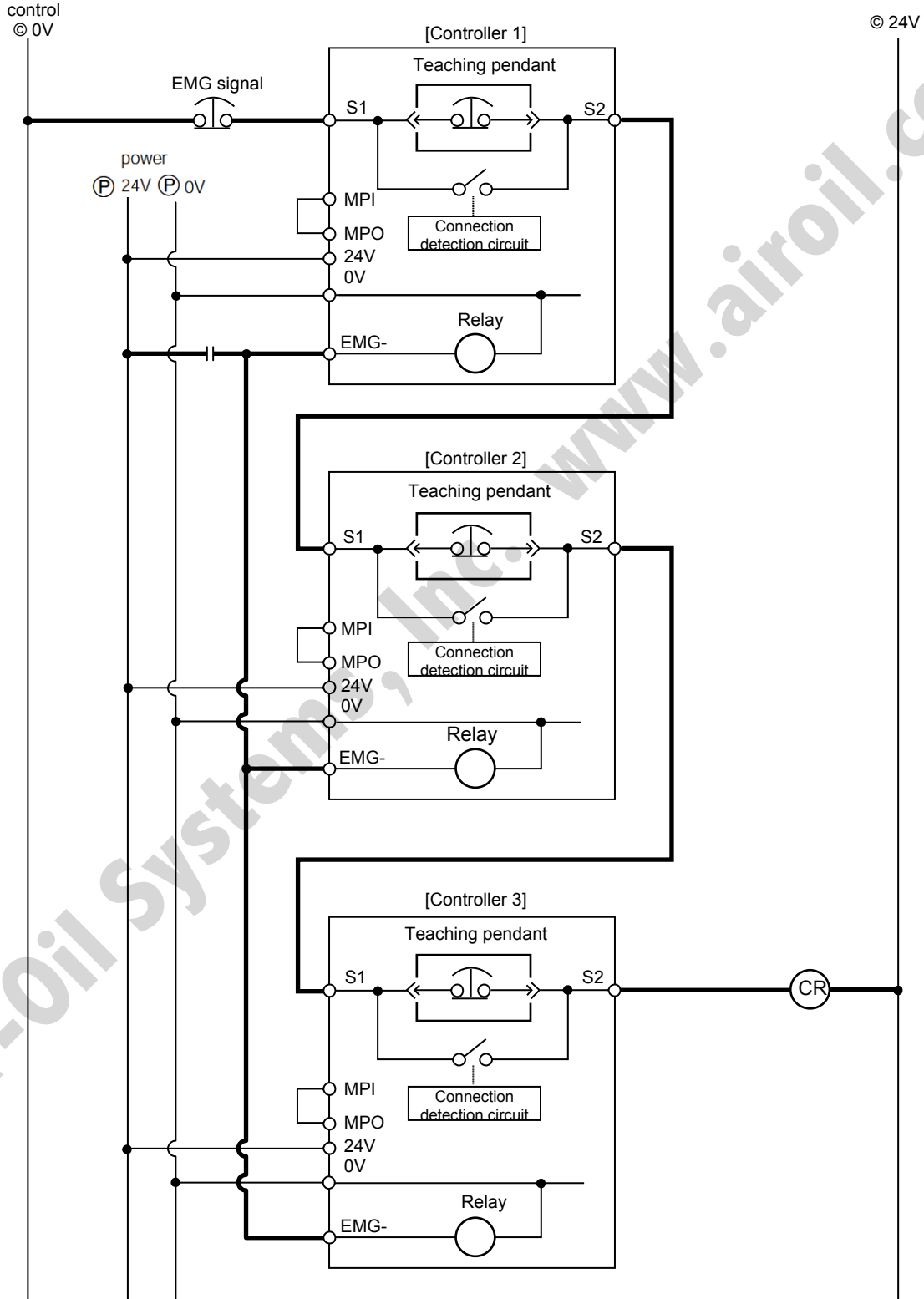

[3] Enabling the EMG switch on the teaching pendant for the connected axis or axes only

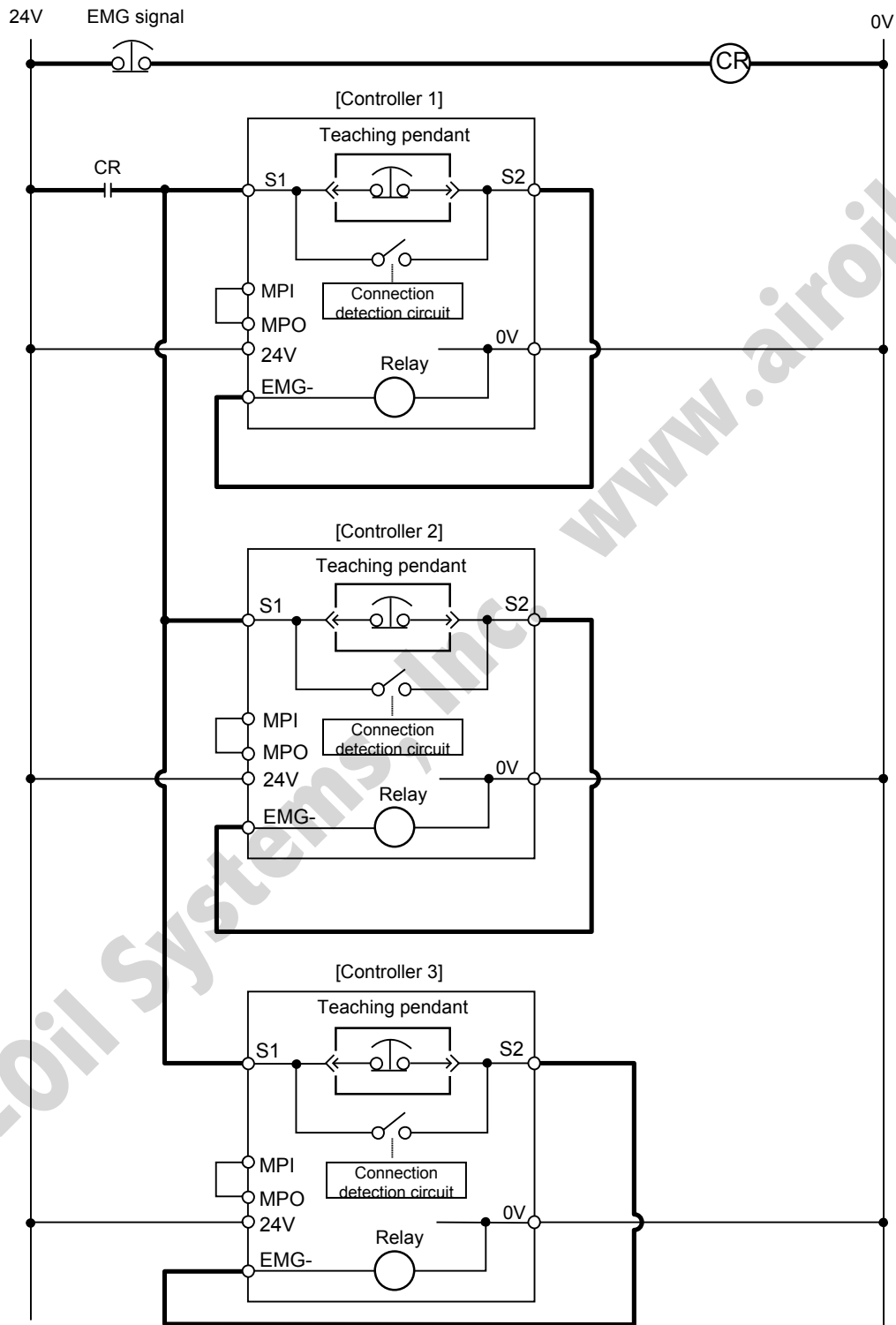

# P CON

- Connecting the teaching pendant to a SIO converter  
Configure the contact circuit for the EMG switch on the teaching pendant using EMG1/EMG2 on the power/emergency-stop terminal block on the SIO converter. (S1/S2 on the controller's terminal block are not used.)

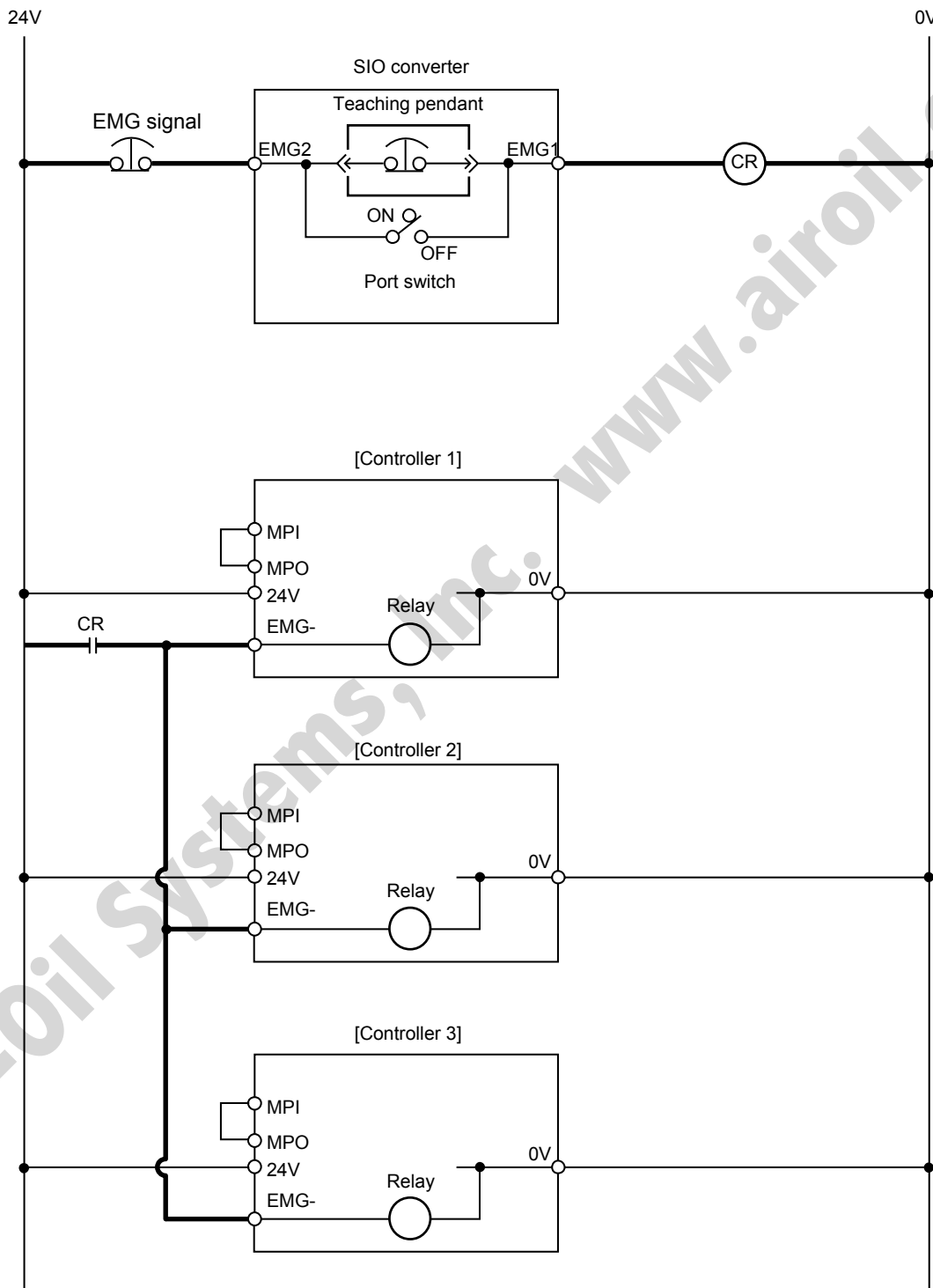

## 4.2 External Drive-Power Cutoff Relay Type (PCON-CG)

### 4.2.1 External Connection Diagram

An example of standard wiring is shown below.

(Note) The encoder cable shown in the example is the standard cable for the controller with the maximum current of 2 A.

As for the robot cable or the cable for the dedicated controller for the high-thrust type, refer to 4.4.2, "Encoder Relay Cable."

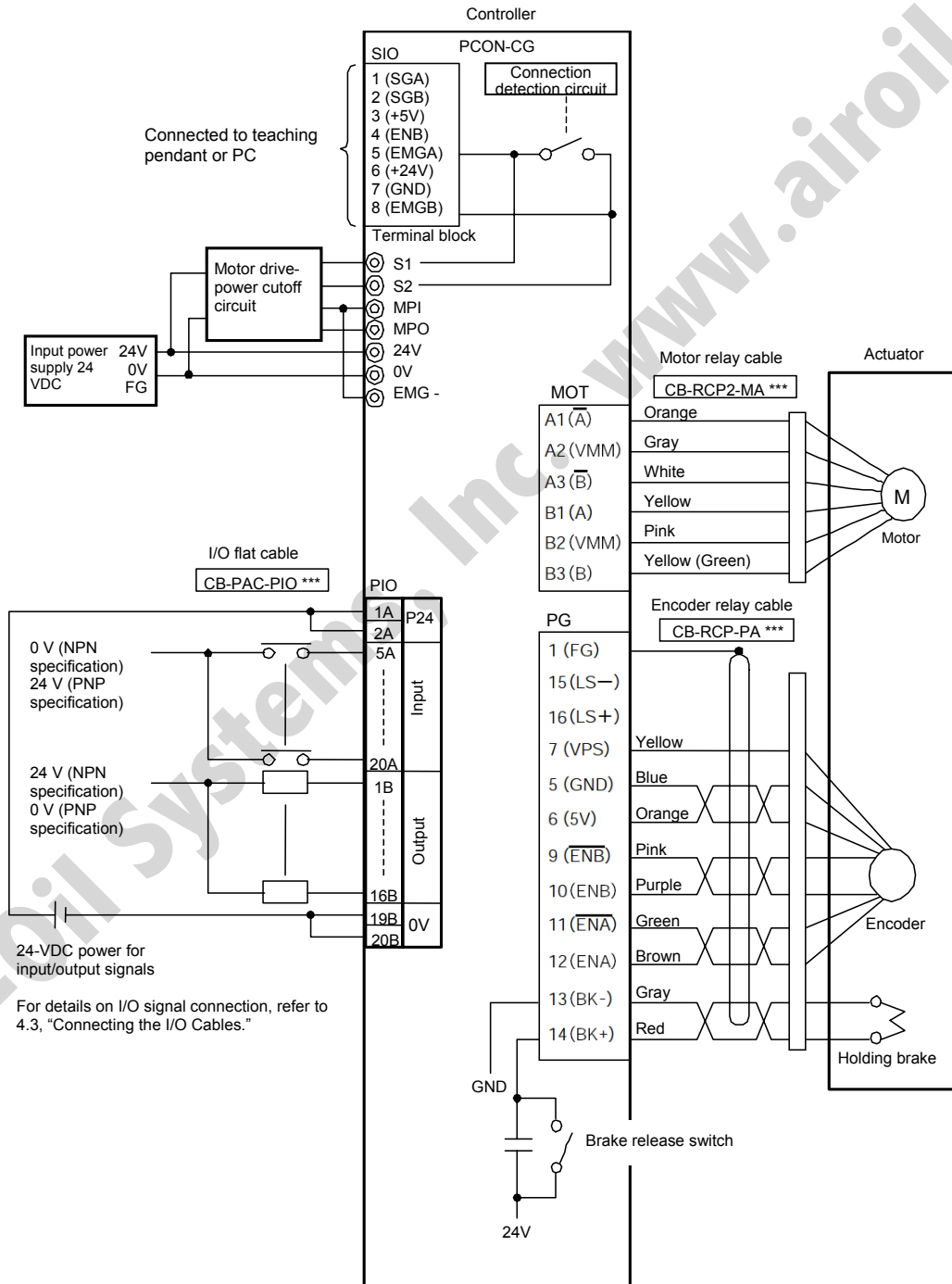

## 4.2.2 Wiring the Power Supply/Emergency-Stop Switch

### (1) Wiring the power supply

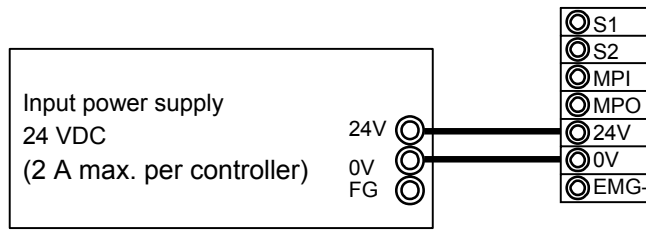

To connect multiple controllers, provide a relay terminal block.  
Use a power cable satisfying the following specifications:

Item	Specification
Applicable wire length	Single wire: $\varnothing 1.0$ / Stranded: $0.8 \text{ mm}^2$ , AWG size 18, (copper wire)
Stripped wire length	10 mm
Temperature rating of insulated sheath	$60^\circ\text{C}$ or above

\* Use a flathead screwdriver with a blade tip of approx. 2.6 mm to push in the wire.



## (2) Wiring the motor power cutoff relay

Explained below is a safety circuit conforming to safety category 2.

The user is responsible for implementing additional safety measures in the actual circuit configuration, such as providing double contactor contacts to prevent fusing.

The circuit illustrated below is for reference purposes only.

- The input side of the motor drive power supply is connected to the MPI terminal, while the output side is connected to the MPO terminal. Connect a contactor or other contact device to these terminals.  
(Note) The rush current must be 8 A or less. The rated current is 2 A.
- The contact for the EMG switch on the teaching pendant is provided by the S1/S2 terminals.  
(Note) When connecting the teaching pendant to a SIO converter, the contact for the EMG switch on the teaching pendant is provided by the EMG1/EMG2 terminals on the SIO converter.

[Example of basic circuit]

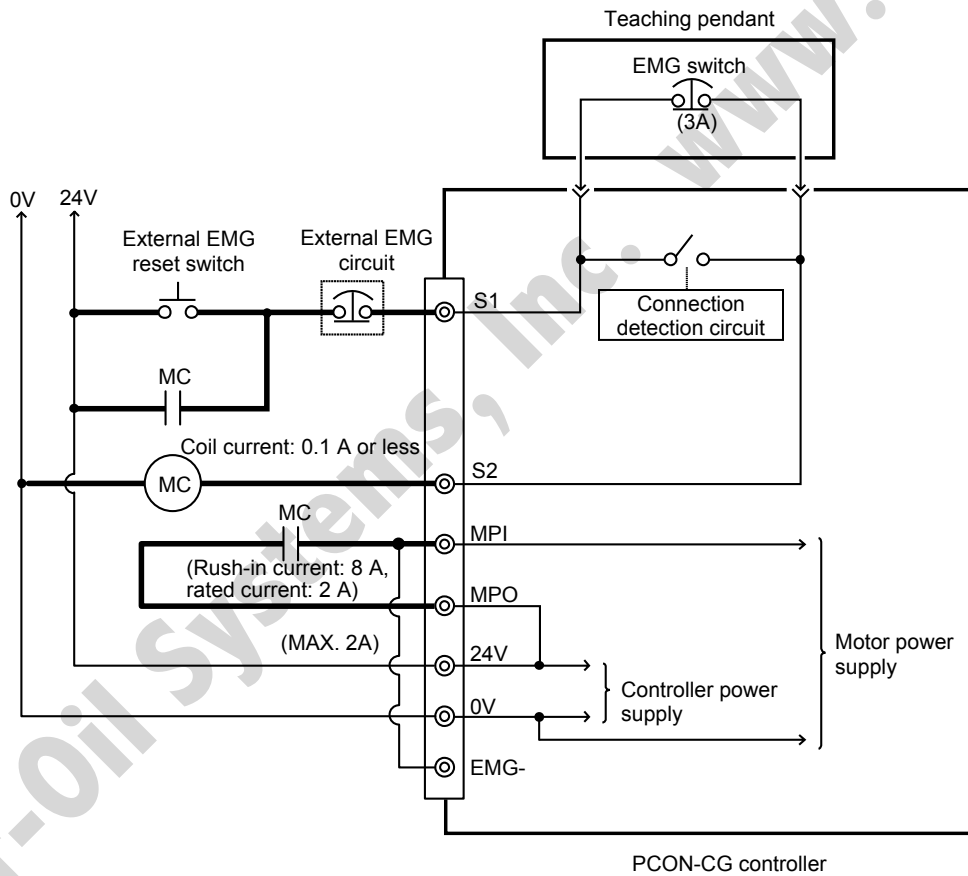

[Connection example of a multiple-axis configuration]

## Input power supply

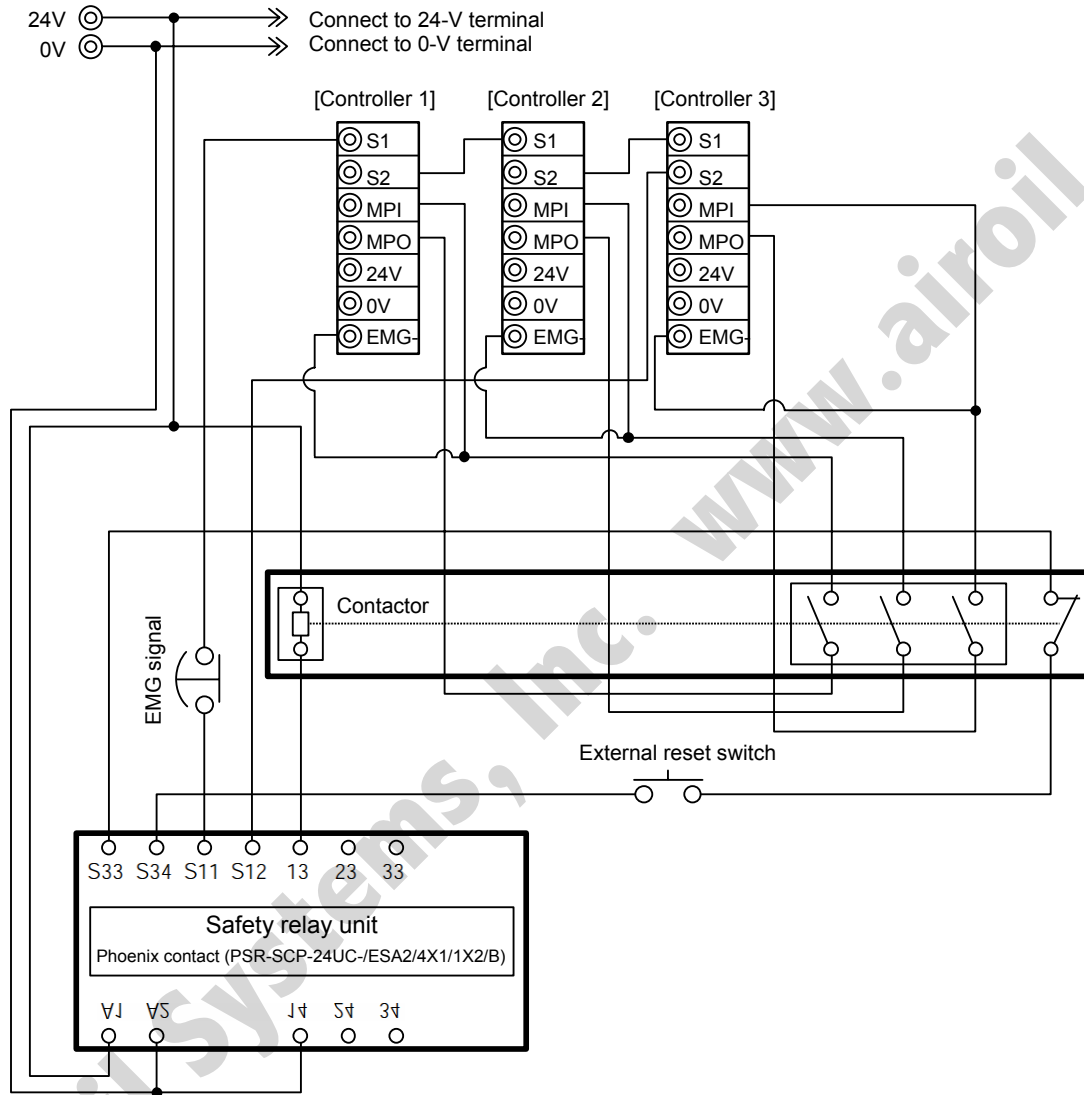

## 4.3 Connecting the I/O Cables

- PIO pattern 0 [Standard Type]

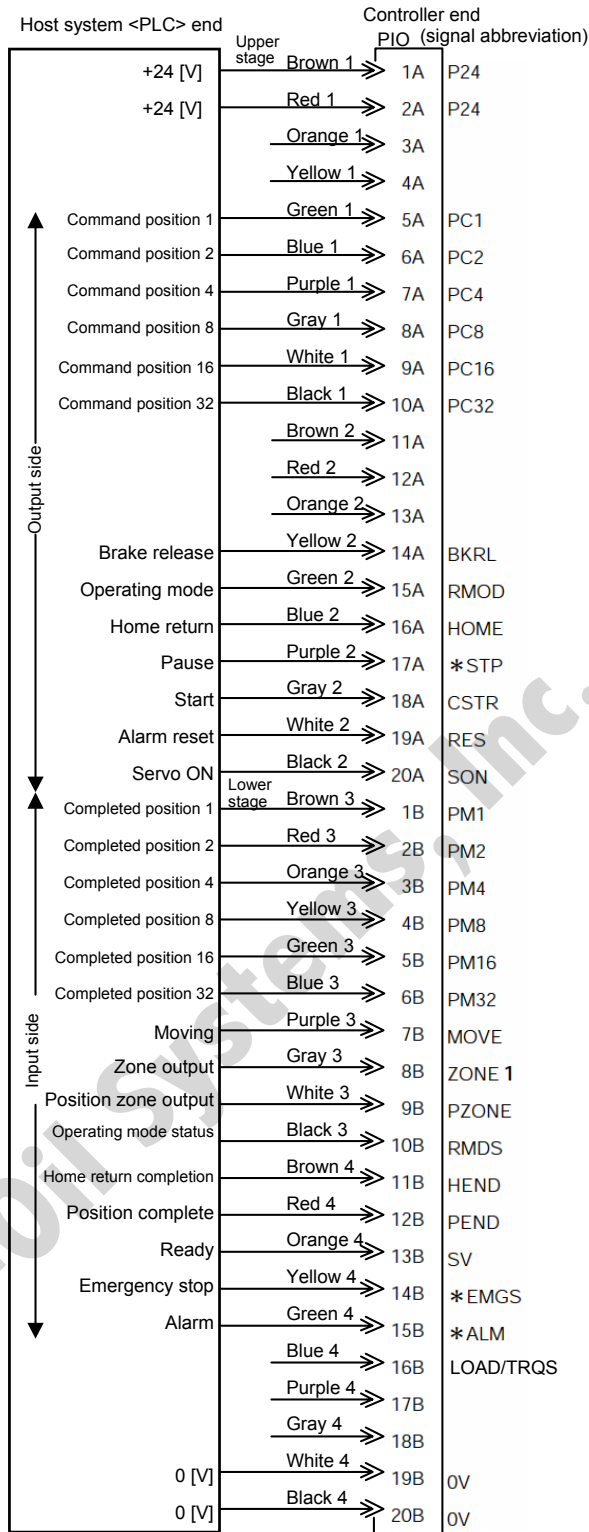

(Note) \*STP, \*ALM and \*EMGS are based on the negative logic.

• PIO pattern 1 [Teaching Type]

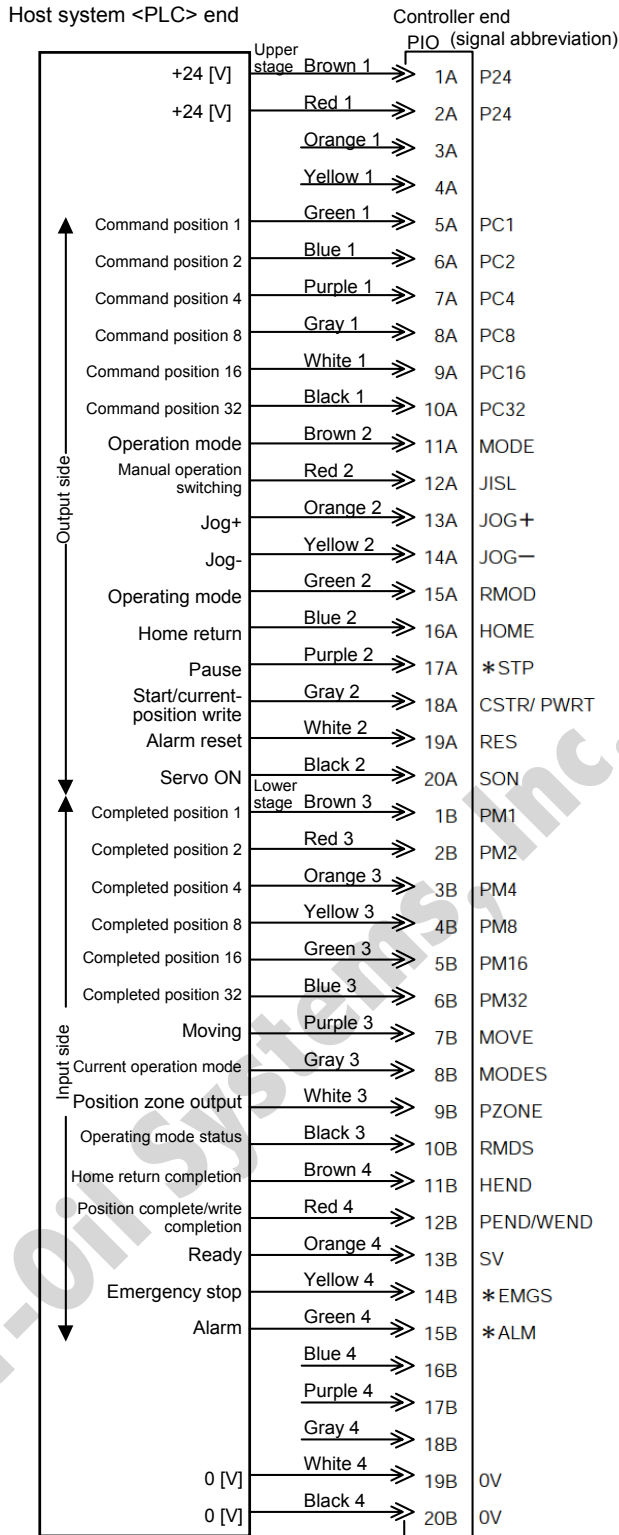

(Note) \*STP, \*ALM and \*EMGS are based on the negative logic.

• PIO pattern 2 [256-piont mode]

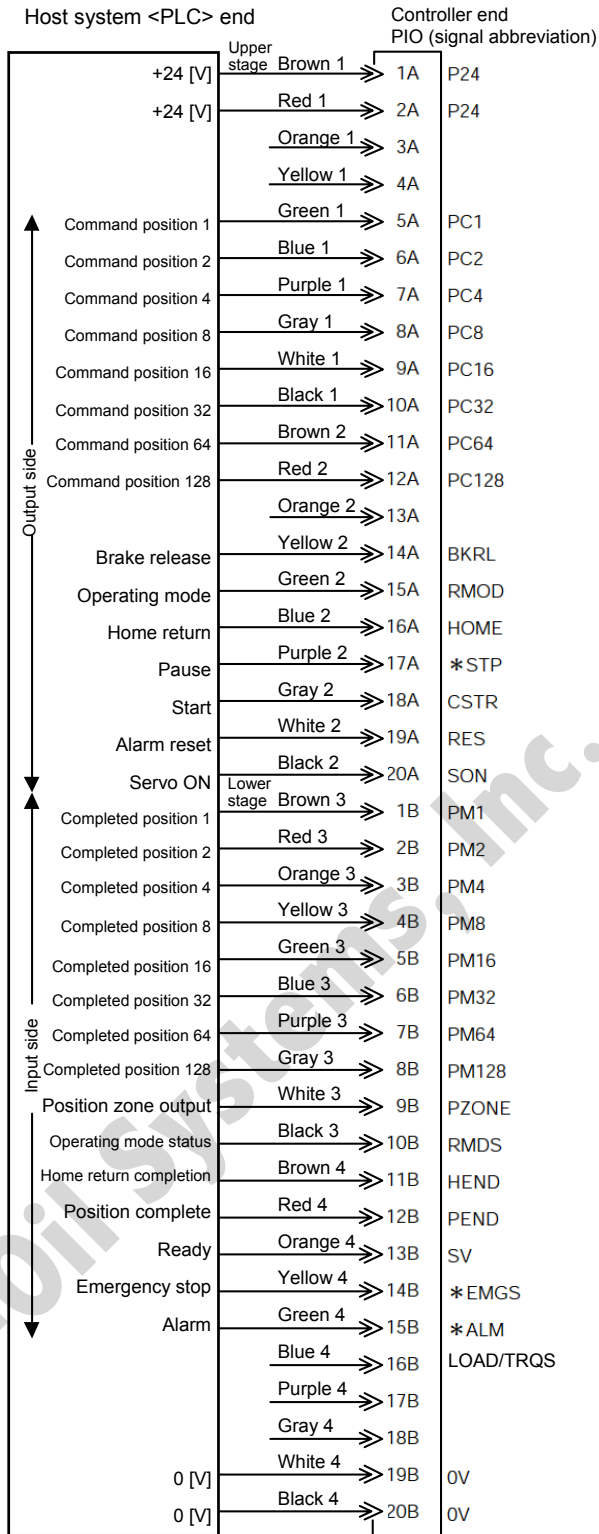

(Note) \*STP, \*ALM and \*EMGS are based on the negative logic.

- PIO pattern 3 [512-piont mode]

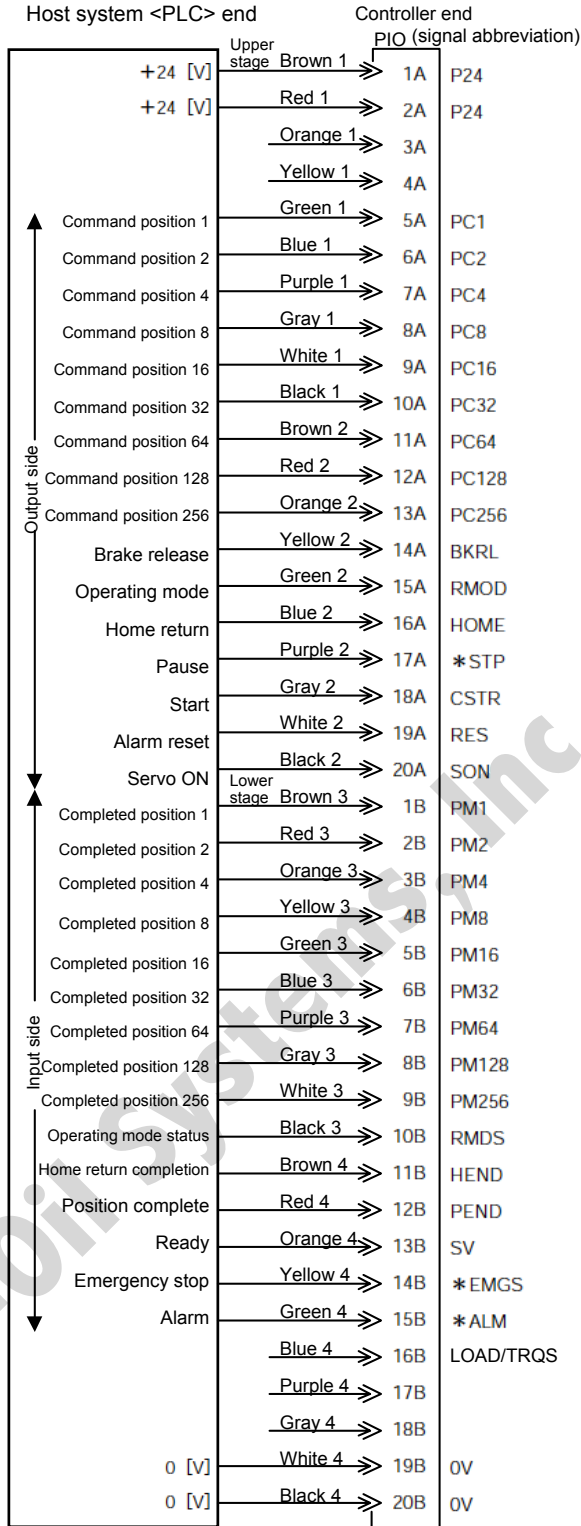

(Note) \*STP, \*ALM and \*EMGS are based on the negative logic.

• PIO pattern 4 [Solenoid valve mode 1]

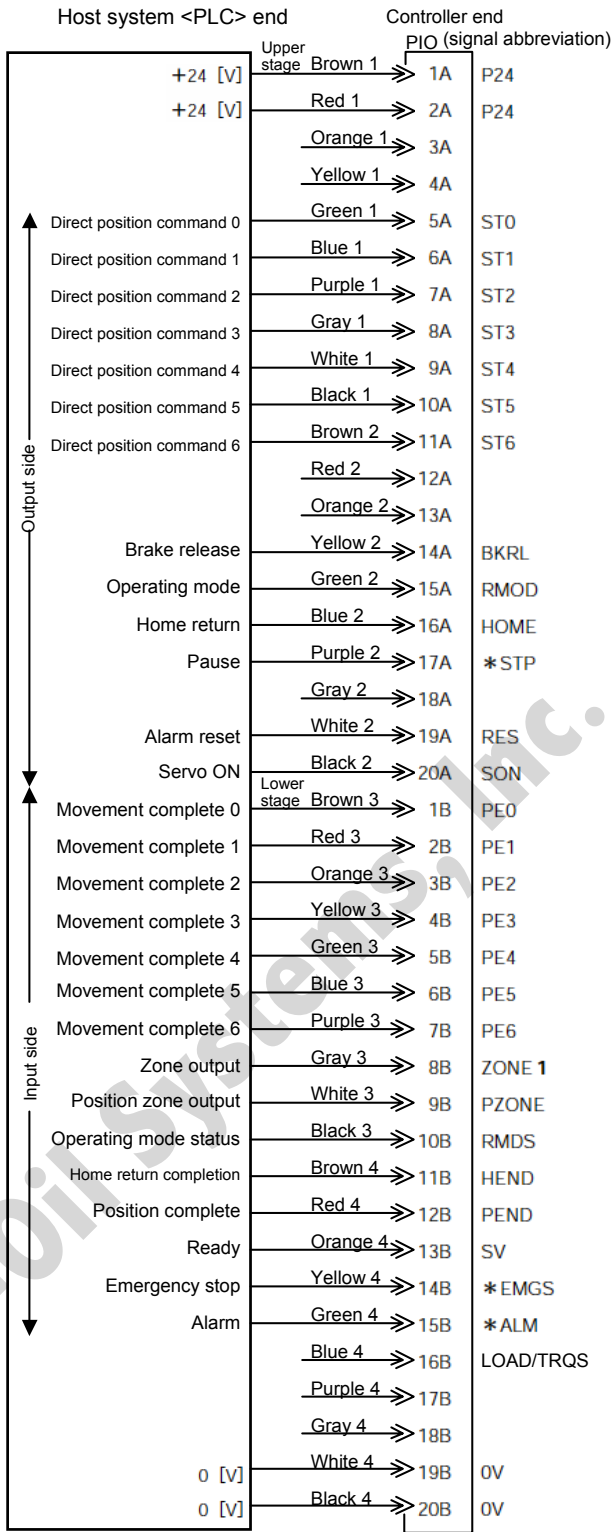

(Note) \*STP, \*ALM and \*EMGS are based on the negative logic.

● PIO pattern 5 [Solenoid valve mode 2]

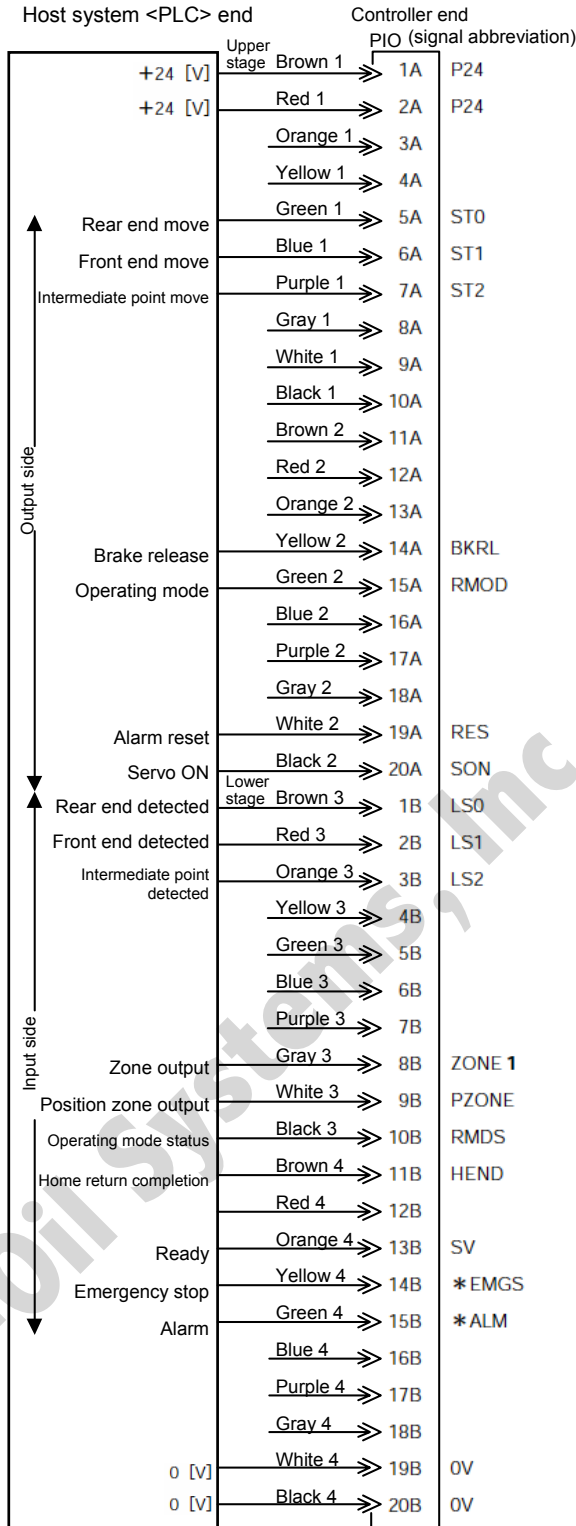

(Note) \*STP, \*ALM and \*EMGS are based on the negative logic.



# P CON \_\_\_\_\_

Caution: When performing a continuity check of the flat cable, pay due attention not to expand the female pins in the connector. It may cause contact failure and disable normal operation of the controller.

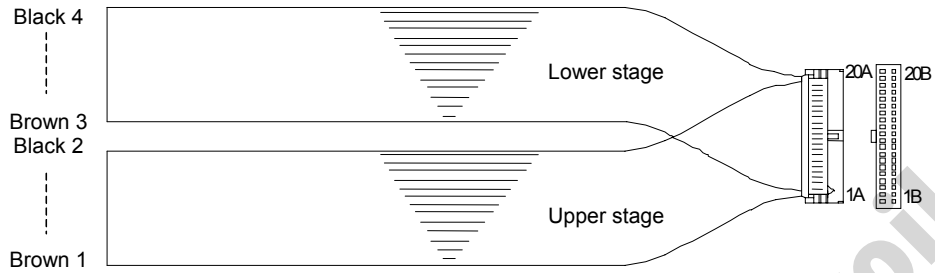

Air-Oil Systems, Inc. www.airoll.com

## 4.4 Connecting the Actuator

### 4.4.1 Motor Relay Cable

- Connect the motor relay cable to the MOT connector.  
Signal table for the controller-end connector (CN2)

Pin No.	Signal	Wire color	Description
A1	$\bar{A}$	Orange	Motor drive line (phase -A)
A2	VMM	Gray	Motor power line
A3	$\bar{B}$	White	Motor drive line (phase -B)
B1	A	Yellow	Motor drive line (phase +A)
B2	VMM	Pink	Motor power line
B3	B	Yellow (Green)	Motor drive line (phase +B)

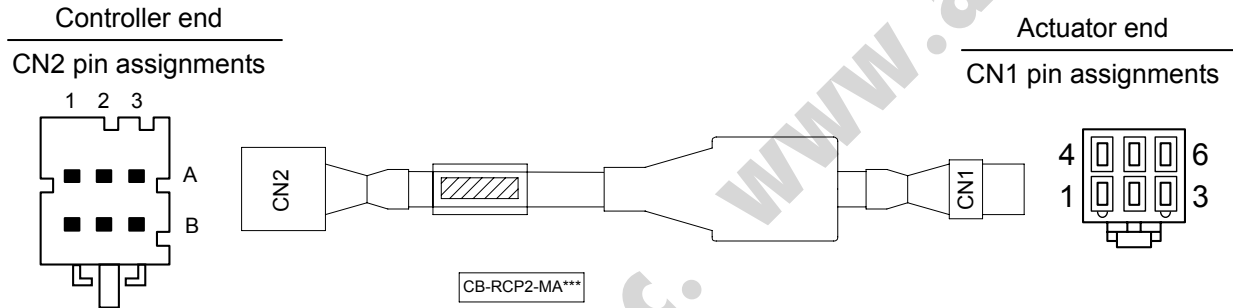

CN2		
Cable color	Signal name	Pin name
Orange	$\bar{A}$	A1
Gray	VMM	A2
White	$\bar{B}$	A3
Yellow	A	B1
Pink	VMM	B2
Yellow (Green)	B	B3

Housing: 1-1318119-3 (AMP)  
Receptacle contact: 1318107-1

CN1		
Pin name	Signal name	Cable color
1	A	Yellow
2	VMM	Gray
3	$\bar{A}$	Orange
4	B	Yellow (Green)
5	VMM	Pink
6	$\bar{B}$	White

Housing: SLP-06V (J.S.T. Mfg.)  
Socket contact: BSF-21T-P1.4

## 4.4.2 Encoder Relay Cable

- Connect the encoder relay cable to the PG connector.
- Signal table for the controller-end connector (CN2)

Pin No.	Signal name	Description
1	F.G	Shielded wire
2	-	(Not used)
3	-	(Not used)
4	-	(Not used)
5	GND	Encoder power output
6	5V	
7	VPS	Encoder control signal output
8	-	(Reserved)
9	$\overline{\text{EN B}}$	Encoder differential signal phase-B input
10	EN B	
11	$\overline{\text{EN A}}$	Encoder differential signal phase-A input
12	EN A	
13	BK -	Negative side of the brake power supply
14	BK +	Positive side of the brake power supply
15	LS -	Home check sensor
16	LS +	

Controller end

CN2 pin assignments

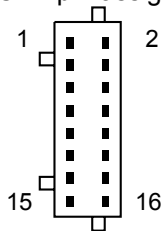

Actuator end

CN1 pin assignments

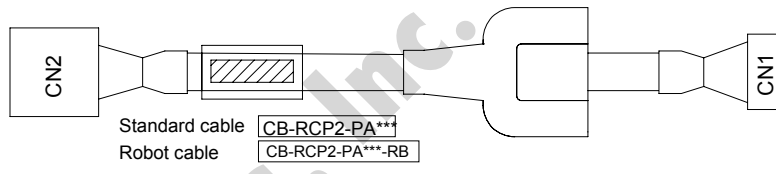
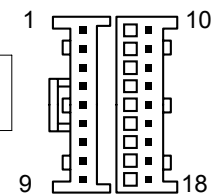

CN2

Cable color		Signal name	Pin name
Robot cable	Standard cable		
-	-	LS+	16
-	-	LS-	15
Purple	Red	BK+	14
White (with purple)	Gray	BK-	13
Blue	Brown	ENA	12
White (with blue)	Green	$\overline{\text{EN A}}$	11
Yellow	Purple	ENB	10
White (with yellow)	Pink	$\overline{\text{EN B}}$	9
-	-	(Reserved)	8
Green	Yellow	VPS	7
Red	Orange	5V	6
White (with red)	Blue	GND	5
-	-	-	4
-	-	-	3
-	-	-	2
Drain	Drain	F.G	1

CN1

Pin name	Signal name	Cable color	
		Standard cable	Robot cable
1	ENA	Brown	Blue
2	$\overline{\text{EN A}}$	Green	White (with blue)
3	ENB	Purple	Yellow
4	$\overline{\text{EN B}}$	Pink	White (with yellow)
5	-	-	-
6	-	-	-
7	-	-	-
8	-	-	-
9	GND	Blue	White (with red)
10	5V	Orange	Red
11	VPS	Yellow	Green
12	-	-	-
13	-	-	-
14	-	-	-
15	-	-	-
16	BK+	Red	Purple
17	BK-	Gray	White (with purple)
18	F.G	Drain	Drain

Housing: PHDR-16VS (J.S.T. Mfg.)  
Contact: SPHD-001T-P0.5

Housing: XMP-18V (J.S.T. Mfg.)  
Contact: BXA-001T-P0.6  
Retainer: XMS-09V

## 4.4.3 Encoder Relay Cable [Large-capacity 6-A Type Controller]

- Connect the encoder relay cable to the ENC connector.
- Signal table for the controller-end connector (CN2)

Pin No.	Signal name	Description
1	F.G	Shielded wire
2	-	(Not used)
3	-	(Not used)
4	5V	Encoder power output
5	GND	
6	-	(Not used)
7	VPS	Encoder control signal output
8	-	(Reserved)
9	$\overline{\text{EN B}}$	Encoder differential signal phase-B input
10	$\overline{\text{EN B}}$	
11	$\overline{\text{EN A}}$	Encoder differential signal phase-A input
12	$\overline{\text{EN A}}$	
13	BK -	Negative side of the brake power supply
14	BK +	Positive side of the brake power supply
15	-	(Reserved)
16	-	(Reserved)

Controller end  
CN2 pin assignments

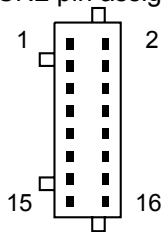

Actuator end  
CN1 pin assignments

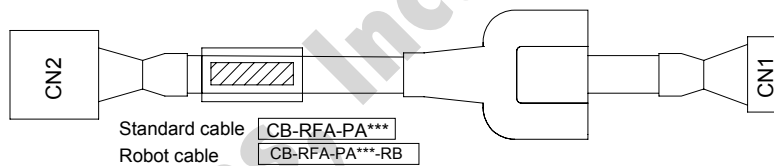
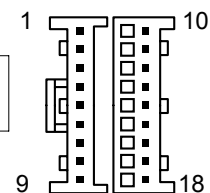

CN2

Cable color		Signal name	Pin name
Robot cable	Standard cable		
-	-	(Reserved)	16
-	-	(Reserved)	15
Purple	Red	BK +	14
White (with purple)	Gray	BK -	13
Blue	Brown	ENA	12
White (with blue)	Green	ENA	11
Yellow	Purple	ENB	10
White (with yellow)	Pink	$\overline{\text{ENB}}$	9
-	-	(Reserved)	8
Green	Yellow	VPS	7
-	-	-	6
White (with red)	Blue	GND	5
Red	Orange	5V	4
-	-	-	3
-	-	-	2
Drain	Drain	F.G	1

Housing: PHDR-16VS (J.S.T. Mfg.)  
Contact: SPHD-001T-P0.5

CN1

Pin name	Signal name	Cable color	
		Standard cable	Robot cable
1	ENA	Brown	Blue
2	$\overline{\text{EN A}}$	Green	White (with blue)
3	ENB	Purple	Yellow
4	$\overline{\text{EN B}}$	Pink	White (with yellow)
5	-	-	-
6	-	-	-
7	-	-	-
8	-	-	-
9	GND	Blue	White (with red)
10	-	-	-
11	VPS	Yellow	Green
12	5V	Orange	Red
13	-	-	-
14	-	-	-
15	-	-	-
16	BK +	Red	Purple
17	BK -	Gray	White (with purple)
18	F.G	Drain	Drain

Housing: XMP-18V (J.S.T. Mfg.)  
Contact: BXA-001T-P0.6  
Retainer: XMS-09V

## 4.5 Connecting the Communication Cable

Connect the communication cable to the SIO connector.

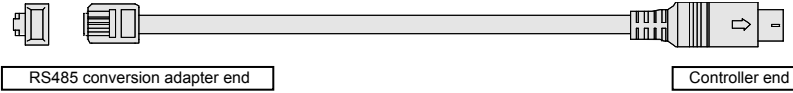

CB-RCA-SIO\*\*\*

Pin assignments of the cable-end connector

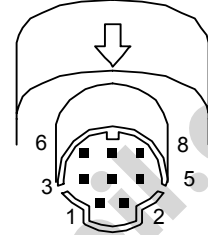

Cable color	Signal name	Pin No.	Pin No.	Signal name	Cable color
Brown	5V	1	1	SGA	Yellow
Yellow	SGA	2	2	SGB	Orange
Red	GND	3	3	5V	Brown/Green
Orange	SGB	4	4	EMGS	-
Blue	GND	5	5	EMGA	Black
Green	5V	6	6	24V	-
Shorting wire UL1004AWG28 (black)			7	GND	Red/Blue
Shielded, not connected			8	EMGB	Black
			FG	Shielded	

www.air-oil.com  
Air-Oil Systems, Inc.

## 5. I/O Signal Control and Signal Functions

### 5.1 Interface Circuit

The standard interface specification of the controller is NPN, but the PNP specification is also available as an option.

To prevent confusion during wiring, the NPN and PNP specifications use the same power line configuration. Accordingly, there is no need to reverse the power signal assignments for a PNP controller.

#### 5.1.1 External Input Specifications

Item	Specification
Number of input points	16 points
Input voltage	24 VDC $\pm$ 10%
Input current	5 mA/point
Operating voltage	ON voltage: Min. 18 V (3.5 mA)
	OFF voltage: Max. 6 V (1 mA)
Leak current	1 mA or less/point
Insulation method	Photocoupler

Internal circuit configuration  
[NPN specification]

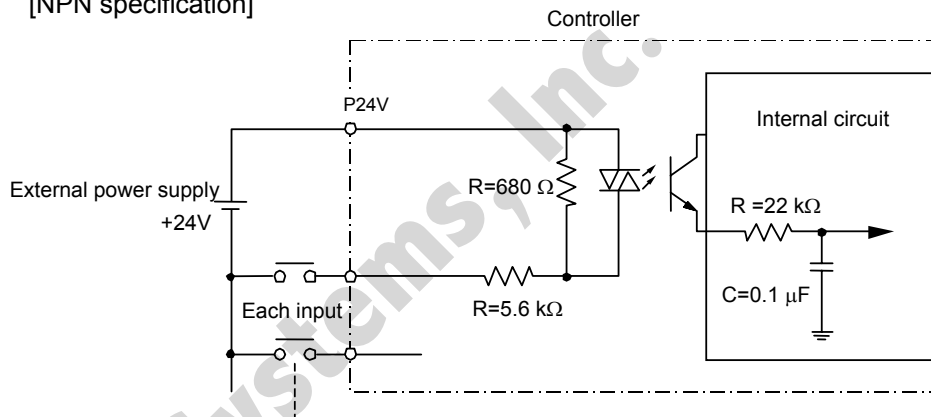

[PNP specification]

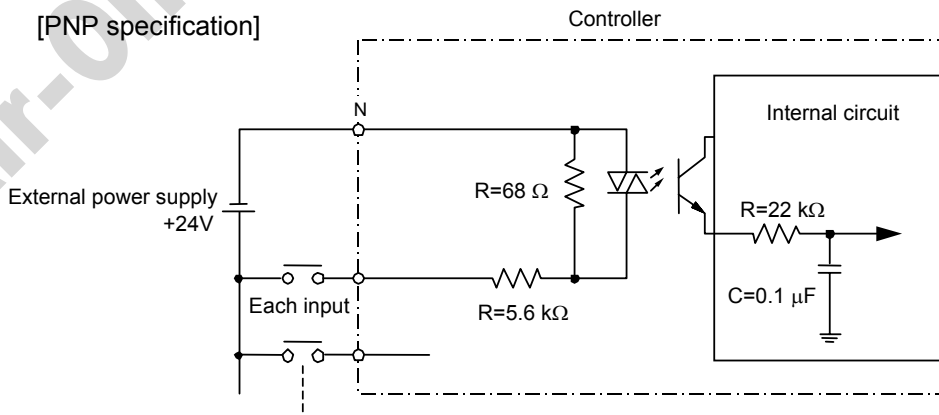

## 5.1.2 External Output Specifications

Item	Specification
Number of output points	16 points
Rated load voltage	24 VDC
Maximum current	50 mA/point
Residual voltage	2V or less
Insulation method	Photocoupler

Internal circuit configuration  
[NPN specification]

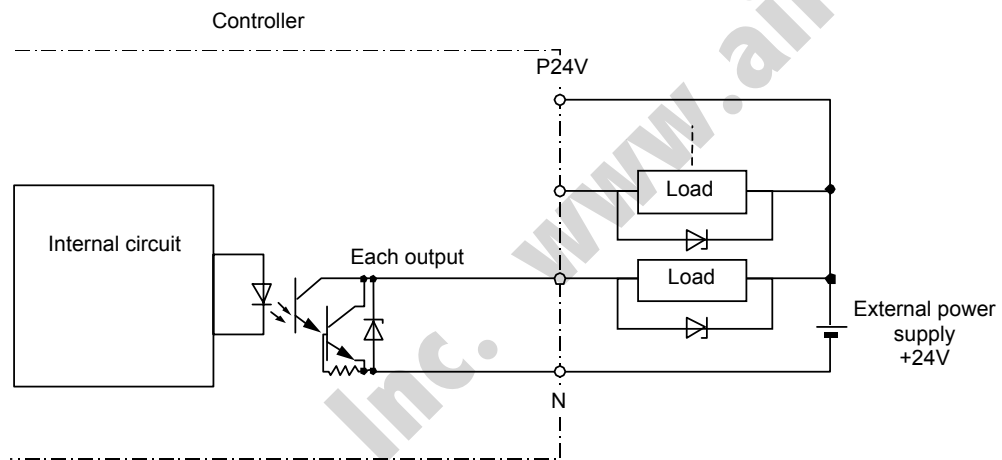

[PNP specification]

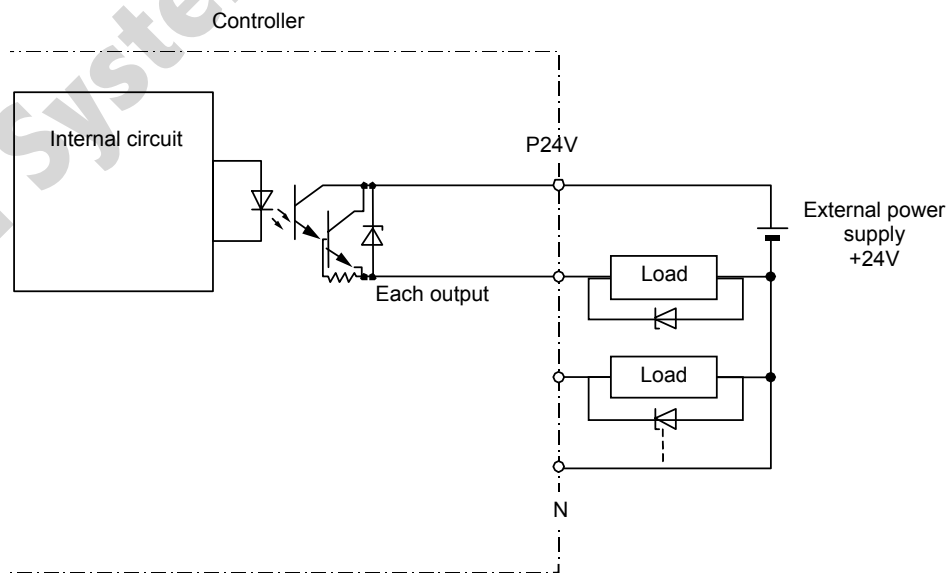

## 5.2 PIO Patterns and Signal Assignments

This controller provides six PIO pattern types to meet the needs of various applications. To select a desired type, set a corresponding value from 0 to 5 in parameter No. 25 (PIO pattern selection).

The features of each PIO pattern are explained below:

Parameter No. 25 setting	Feature of PIO pattern
0	Positioning mode (Standard type) A basic type supporting 64 positioning points and two zone outputs. * How to set zone boundaries within which to output a zone signal: Zone boundaries are set using parameter Nos. 1 and 2 for one zone output, and in the position table for another zone output.
1	Teaching mode (Teaching type) In this type, 64 positioning points and one zone output (boundaries are set in the position table) are supported. In addition to the normal positioning mode, the user can also select the teaching mode in which the actuator can be jogged via I/Os and the current actuator position can be written to a specified position. (Note) Positions can be rewritten by approximately 100,000 times.
2	256-point mode (256-point positioning type) The number of positioning points is increased to 256, so only one zone output is available (boundaries are set in the position table).
3	512-point mod (512-point positioning) The number of positioning points is increased to 512, so no zone output is available.
4	Solenoid valve mode 1 (7-point type) The number of positioning points is limited to seven to offer separate direct command inputs and movement complete outputs. PLC ladder sequence circuits can be designed easily.
5	Solenoid valve mode 2 (3-point type) Use of the controller as an air cylinder is assumed in this type. Movement complete output signals function differently in this type, compared to the 7-point type. Specifically, the signal functions not only to "indicate movement complete," but also to "detect a position" in the same manner as auto-switches of an air cylinder. Push & hold operation cannot be performed.

Quick reference table for functions available under each PIO pattern (○: Available, X: Not available)

No. 25	Number of positioning points	Input signals				Output signals		
		Brake release	Home return	Jog	Current-position write	Zone	Position zone	Ready
0	64 points	○	○	x	x	○	○	○
1	64 points	x	○	○	○	x	○	○
2	256 points	○	○	x	x	x	○	x
3	512 points	○	○	x	x	x	x	x
4	7 points	○	○	x	x	○	○	x
5	3 points	○	x	x	x	○	○	x

(Note) For "Zone" and "Position zone," different methods are used to set boundaries defining the range within which the zone signal will turn ON.

"Zone" is set by parameter Nos. 1 and 2, and thus its setting will become effective after home return is completed.

"Position zone" is set in the "Zone+" and "Zone-" fields for each position number in the position table, and thus its setting will become effective after a movement command is input.



## 5.2.1 Explanation of Signal Names

The following explains the signal names, and gives a function overview of each signal.

In the explanation of operation timings provided in a later section, each signal is referenced by its self-explanatory name for clarity. If necessary, however, such as when marker tubes are inserted as a termination of the flat cable, use the signal abbreviations.

- PIO pattern = 0: Positioning mode [Standard type]

Category	Signal name	Signal abbreviation	Function overview
Input	Command position number	PC1	The target position number is input. A command position number must be specified by 6 ms before the start signal (CSTR) turns ON.
		PC2	
		PC4	
		PC8	
		PC16	
		PC32	
	Brake release	BKRL	This signal is used on an actuator equipped with a brake to forcibly release the brake.
	Operating mode	RMDO	This signal switches the operating mode between AUTO and MANU.
	Home return	HOME	Home return operation is started at a rise edge of this signal.
	*Pause	*STP	ON: Actuator can be moved, OFF: Actuator decelerates to a stop
Start	CSTR	The actuator will start moving at a rise edge of this signal.	
Alarm reset	RES	An alarm is reset at a rise edge of this signal.	
Servo ON	SON	The servo remains ON while this signal is ON. The servo remains OFF while this signal is OFF.	
Output	Completed position number	PM1	The relevant position number is output when positioning has completed. The signal will turn OFF when the next start signal is received. It is used by the PLC to check if the commanded position has definitively been reached, and also to provide a position interlock, etc.
		PM2	
		PM4	
		PM8	
		PM16	
		PM32	
	Moving	MOVE	This signal will remain ON while the actuator is moving, and OFF while the actuator is standing still. It is used to determine whether the actuator is moving or paused.
	Zone	ZONE1	This signal becomes effective after home return. It will turn ON when the current actuator position enters the range set by the parameters and remain ON until the actuator exits the range.
	Position zone	PZONE	This signal becomes effective after a position movement command is input. It will turn ON when the current actuator position enters the range specified in the position table and remain ON until the actuator exits the range.
	Operating mode status	RMDS	This signal will remain OFF during the AUTO mode, and ON during the MANU mode.
	Home return completion	HEND	This signal is OFF immediately after the power is input, and turns ON when home return has completed.
	Position complete	PEND	This signal turns ON when the target position was reached and the actuator has entered the specified in-position range. It is used to determine whether positioning has completed.
	Ready	SV	This signal is always output once the servo is turned ON and the controller is ready to operate.
	*Emergency stop	*EMGS	When this signal is OFF, it means that an emergency stop is being actuated.
*Alarm	*ALM	This signal remains ON in normal conditions of use and turns OFF when an alarm generates.	
Load output judgment status	LOAD	This signal will turn ON when the command torque exceeds the threshold while the actuator is inside the check range. Note) Dedicated output signal for the PCON-CF	
Torque level status	TRQS	This signal will turn ON when the motor current reaches the threshold. Note) Dedicated output signal for the PCON-CF	

● PIO pattern = 1: Teaching mode [Teaching type]

Category	Signal name	Signal abbreviation	Function overview
Input	Command position number	PC1	The target position number is input. A command position number must be specified by 6 ms before the start signal (CSTR) turns ON.
		PC2	
		PC4	
		PC8	
		PC16	
		PC32	
	Operation mode	MODE	Mode selection (ON: Teaching mode, OFF: Normal mode)
	Jog/inching switching	JISL	OFF: Jog, ON: Inching
	+jog/inching movement	JOG+	The actuator will start jogging or inching in the positive direction at an ON edge of this signal.
	-jog/inching movement	JOG-	The actuator will start jogging or inching in the negative direction at an ON edge of this signal.
	Operating mode	RMDO	This signal switches the operating mode between AUTO and MANU.
	Home return	HOME	Home return operation is started at a rise edge of this signal.
	*Pause	*STP	ON: Actuator can be moved, OFF: Actuator decelerates to a stop
Start	CSTR	The actuator will start moving at a rise edge of this signal.	
Current-position write	PWRT	When this signal has remained ON for 20 msec or longer, the current position will be stored under the position number selected by PC1 to PC32.	
Alarm reset	RES	An alarm is reset at a rise edge of this signal.	
Servo ON	SON	The servo remains ON while this signal is ON. The servo remains OFF while this signal is OFF.	
Output	Completed position number	PM1	The relevant position number is output when positioning has completed. The signal will turn OFF when the next start signal is received. It is used by the PLC to check if the commanded position has definitively been reached, and also to provide a position interlock, etc.
		PM2	
		PM4	
		PM8	
		PM16	
		PM32	
	Moving	MOVE	This signal will remain ON while the actuator is moving, and OFF while the actuator is standing still. It is used to determine whether the actuator is moving or paused.
	Mode status	MODES	ON: Teaching mode, OFF: Normal mode
	Position zone	PZONE	This signal becomes effective after a position movement command is input. It will turn ON when the current actuator position enters the range specified in the position table and remain ON until the actuator exits the range.
	Operating mode status	RMDS	This signal will remain OFF during the AUTO mode, and ON during the MANU mode.
	Home return completion	HEND	This signal is OFF immediately after the power is input, and turns ON when home return has completed.
Position complete	PEND	This signal turns ON when the target position was reached and the actuator has entered the specified in-position range. It is used to determine whether positioning has completed.	
Write completion	WEND	This signal is output upon completion of writing to the nonvolatile memory in response to a current-position write command (PWRT).	
Ready	SV	This signal is always output once the servo is turned ON and the controller is ready to operate.	
*Emergency stop	*EMGS	OFF: Emergency stop has been actuated	
*Alarm	*ALM	This signal remains ON in normal conditions of use and turns OFF when an alarm generates.	

● PIO pattern = 2: 256-point mode [256-point type]

Category	Signal name	Signal abbreviation	Function overview
Input	Command position number	PC1	The target position number is input. A command position number must be specified by 6 ms before the start signal (CSTR) turns ON.
		PC2	
		PC4	
		PC8	
		PC16	
		PC32	
		PC64	
		PC128	
	Brake release	BKRL	This signal is used on an actuator equipped with a brake to forcibly release the brake.
	Operating mode	RMDO	This signal switches the operating mode between AUTO and MANU.
Home return	HOME	Home return operation is started at a rise edge of this signal.	
*Pause	*STP	ON: Actuator can be moved, OFF: Actuator decelerates to a stop	
Start	CSTR	The actuator will start moving at a rise edge of this signal.	
Alarm reset	RES	An alarm is reset at a rise edge of this signal.	
Servo ON	SON	The servo remains ON while this signal is ON. The servo remains OFF while this signal is OFF.	
Output	Completed position number	PM1	The relevant position number is output when positioning has completed. The signal will turn OFF when the next start signal is received. It is used by the PLC to check if the commanded position has definitively been reached, and also to provide a position interlock, etc.
		PM2	
		PM4	
		PM8	
		PM16	
		PM32	
		PM64	
		PM128	
	Position zone	PZONE	This signal becomes effective after a position movement command is input. It will turn ON when the current actuator position enters the range specified in the position table and remain ON until the actuator exits the range.
	Operating mode status	RMDS	This signal will remain OFF during the AUTO mode, and ON during the MANU mode.
	Home return completion	HEND	This signal is OFF immediately after the power is input, and turns ON when home return has completed.
	Position complete	PEND	This signal turns ON when the target position was reached and the actuator has entered the specified in-position range. It is used to determine whether positioning has completed.
	Ready	SV	This signal is always output once the servo is turned ON and the controller is ready to operate.
*Emergency stop	*EMGS	OFF: Emergency stop has been actuated	
*Alarm	*ALM	This signal remains ON in normal conditions of use and turns OFF when an alarm generates.	
Load output judgment status	LOAD	This signal will turn ON when the command torque exceeds the threshold while the actuator is inside the check range. Note) Dedicated output signal for the PCON-CF	
Torque level status	TRQS	This signal will turn ON when the motor current reaches the threshold. Note) Dedicated output signal for the PCON-CF	

● PIO pattern = 3: 512-point mode [512-point type]

Category	Signal name	Signal abbreviation	Function overview
Input	Command position number	PC1	The target position number is input. A command position number must be specified by 6 ms before the start signal (CSTR) turns ON.
		PC2	
		PC4	
		PC8	
		PC16	
		PC32	
		PC64	
		PC128	
		PC256	
	Brake release	BKRL	This signal is used on an actuator equipped with a brake to forcibly release the brake.
Operating mode	RMDO	This signal switches the operating mode between AUTO and MANU.	
Home return	HOME	Home return operation is started at a rise edge of this signal.	
*Pause	*STP	ON: Actuator can be moved, OFF: Actuator decelerates to a stop	
Start	CSTR	The actuator will start moving at a rise edge of this signal.	
Alarm reset	RES	An alarm is reset at a rise edge of this signal.	
Servo ON	SON	The servo remains ON while this signal is ON. The servo remains OFF while this signal is OFF.	
Output	Completed position number	PM1	The relevant position number is output when positioning has completed. The signal will turn OFF when the next start signal is received. It is used by the PLC to check if the commanded position has definitively been reached, and also to provide a position interlock, etc.
		PM2	
		PM4	
		PM8	
		PM16	
		PM32	
		PM64	
		PM128	
		PC256	
	Operating mode status	RMDS	This signal will remain OFF during the AUTO mode, and ON during the MANU mode.
Home return completion	HEND	This signal is OFF immediately after the power is input, and turns ON when home return has completed.	
Position complete	PEND	This signal turns ON when the target position was reached and the actuator has entered the specified in-position range. It is used to determine whether positioning has completed.	
Ready	SV	This signal is always output once the servo is turned ON and the controller is ready to operate.	
*Emergency stop	*EMGS	OFF: Emergency stop has been actuated	
*Alarm	*ALM	This signal remains ON in normal conditions of use and turns OFF when an alarm generates.	
Load output judgment status	LOAD	This signal will turn ON when the command torque exceeds the threshold while the actuator is inside the check range. Note) Dedicated output signal for the PCON-CF	
Torque level status	TRQS	This signal will turn ON when the motor current reaches the threshold. Note) Dedicated output signal for the PCON-CF	

● PIO pattern = 4: Solenoid valve mode 1 [7- point type]

Category	Signal name	Signal abbreviation	Function overview
Input	Direct position command 0	ST0	The actuator will start moving to position No. 0 at a rise edge of this signal.
	Direct position command 1	ST1	The actuator will start moving to position No. 1 at a rise edge of this signal.
	Direct position command 2	ST2	The actuator will start moving to position No. 2 at a rise edge of this signal.
	Direct position command 3	ST3	The actuator will start moving to position No. 3 at a rise edge of this signal.
	Direct position command 4	ST4	The actuator will start moving to position No. 4 at a rise edge of this signal.
	Direct position command 5	ST5	The actuator will start moving to position No. 5 at a rise edge of this signal.
	Direct position command 6	ST6	The actuator will start moving to position No. 6 at a rise edge of this signal.
	Brake release	BKRL	This signal is used on an actuator equipped with a brake to forcibly release the brake.
	Operating mode	RMDO	This signal switches the operating mode between AUTO and MANU.
	Home return	HOME	Home return operation is started at a rise edge of this signal.
	*Pause	*STP	ON: Actuator can be moved, OFF: Actuator decelerates to a stop
	Start	CSTR	Movement is started at a rise edge of this signal.
	Alarm reset	RES	An alarm is reset at a rise edge of this signal.
	Servo ON	SON	The servo remains ON while this signal is ON. The servo remains OFF while this signal is OFF.
Output	Movement complete 0	PE0	This signal will turn ON when the actuator completes moving to position No. 0.
	Movement complete 1	PE1	This signal will turn ON when the actuator completes moving to position No. 1.
	Movement complete 2	PE2	This signal will turn ON when the actuator completes moving to position No. 2.
	Movement complete 3	PE3	This signal will turn ON when the actuator completes moving to position No. 3.
	Movement complete 4	PE4	This signal will turn ON when the actuator completes moving to position No. 4.
	Movement complete 5	PE5	This signal will turn ON when the actuator completes moving to position No. 5.
	Movement complete 6	PE6	This signal will turn ON when the actuator completes moving to position No. 6.
	Zone	ZONE1	This signal becomes effective after home return. It will turn ON when the current actuator position enters the range set by the parameters and remain ON until the actuator exits the range.
	Position zone	PZONE	This signal becomes effective after a position movement command is input. It will turn ON when the current actuator position enters the range specified in the position table and remain ON until the actuator exits the range.
	Operating mode status	RMDS	This signal will remain OFF during the AUTO mode, and ON during the MANU mode.
	Home return completion	HEND	This signal is OFF immediately after the power is input, and turns ON when home return has completed.
	Position complete	PEND	This signal is used to determine if the controller is ready following the power on. The controller is ready to perform operation if an emergency stop is not actuated, motor drive power is not cut off (= the servo is on) and the pause signal is input.
	Ready	SV	This signal is always output once the servo is turned ON and the controller is ready to operate.
	*Emergency stop	*EMGS	OFF: Emergency stop has been actuated
	*Alarm	*ALM	This signal remains ON in normal conditions of use and turns OFF when an alarm generates.
	Load output judgment status	LOAD	This signal will turn ON when the command torque exceeds the threshold while the actuator is inside the check range. Note) Dedicated output signal for the PCON-CF
Torque level status	TRQS	This signal will turn ON when the motor current reaches the threshold. Note) Dedicated output signal for the PCON-CF	

● PIO pattern = 5 Solenoid valve mode 2 [3-point type]

Category	Signal name	Signal abbreviation	Function overview
Input	Rear end move command	ST0	The actuator will move toward the rear end while this signal remains at ON level.
	Front end move command	ST1	The actuator will move toward the front end while this signal remains at ON level.
	Intermediate point move command	ST2	The actuator will move toward the intermediate point while this signal remains at ON level.
	Brake release	BKRL	This signal is used on an actuator equipped with a brake to forcibly release the brake.
	Operating mode	RMDO	This signal switches the operating mode between AUTO and MANU.
	Alarm reset	RES	An alarm is reset at a rise edge of this signal.
	Servo ON	SON	The servo remains ON while this signal is ON. The servo remains OFF while this signal is OFF.
Output	Rear end detected	LS0	This signal will remain ON while the rear end is recognized. (This signal is not output during push & hold operation.)
	Front end detected	LS1	This signal will remain ON while the front end is recognized. (This signal is not output during push & hold operation.)
	Intermediate point detected	LS2	This signal will remain ON while the intermediate point is recognized. (This signal is not output during push & hold operation.)
	Zone	ZONE1	This signal becomes effective after home return. It will turn ON when the current actuator position enters the range set by the parameters and remain ON until the actuator exits the range.
	Position zone	PZONE	This signal becomes effective after a position movement command is input. It will turn ON when the current actuator position enters the range specified in the position table and remain ON until the actuator exits the range.
	Operating mode status	RMDS	This signal will remain OFF during the AUTO mode, and ON during the MANU mode.
	Home return completion	HEND	This signal is OFF immediately after the power is input, and turns ON when home return has completed.
	Ready	SV	This signal is always output once the servo is turned ON and the controller is ready to operate.
	*Emergency stop	*EMGS	OFF: Emergency stop has been actuated
	*Alarm	*ALM	This signal remains ON in normal conditions of use and turns OFF when an alarm generates.
	Load output judgment status	LOAD	This signal will turn ON when the command torque exceeds the threshold while the actuator is inside the check range. Note) Dedicated output signal for the PCON-CF
	Torque level status	TRQS	This signal will turn ON when the motor current reaches the threshold. Note) Dedicated output signal for the PCON-CF

## 5.2.2 Signal Assignment Table for Respective PIO Patterns

When creating a PLC sequence or wiring signals, assign each pin correctly by referring to the assignment table below.

When “1 [Teaching type]” is selected, the meaning of each pin number will vary depending on the mode.

Accordingly, also pay due attention to the mode switch timings.

Pin No.	Category	Wire color	Parameter No. 25 setting						
			0	1	2	3	4	5	
1A	+24V	Upper stage	P24						
2A		Brown - 1							
3A		Red - 1							
4A		Orange - 1							
5A	Input	Yellow - 1	(Not used)						
6A		Green - 1	PC1	PC1	PC1	PC1	ST0	ST0	
7A		Blue - 1	PC2	PC2	PC2	PC2	ST1	ST1 (JOG+)	
8A		Purple - 1	PC4	PC4	PC4	PC4	ST2	ST2 (-)	
9A		Gray - 1	PC8	PC8	PC8	PC8	ST3	-	
10A		White - 1	PC16	PC16	PC16	PC16	ST4	-	
11A		Black - 1	PC32	PC32	PC32	PC32	ST5	-	
12A		Brown - 2	-	MODE	PC64	PC64	ST6	-	
13A		Red - 2	-	JISE	PC128	PC128	-	-	
14A		Orange - 2	-	JOG+	-	PC256	-	-	
15A		Yellow - 2	BKRL	JOG-	BKRL	BKRL	BKRL	BKRL	
16A		Green - 2	RMOD						
17A		Blue - 2	HOME						-
18A		Purple - 2	*STP						-
19A		Gray - 2	CSTR	CSTR/PWRT	CSTR	CSTR	-	-	
20A		White - 2	RES						
		Black - 2	SON						
1B		Output	Lower stage	PM1	PM1	PM1	PM1	PE0	LS0
2B			Brown - 3	PM2	PM2	PM2	PM2	PE1	LS1 (TRQS)
3B			Red - 3	PM4	PM4	PM4	PM4	PE2	LS2 (-)
4B	Orange - 3		PM8	PM8	PM8	PM8	PE3	-	
5B	Yellow - 3		PM16	PM16	PM16	PM16	PE4	-	
6B	Green - 3		PM32	PM32	PM32	PM32	PE5	-	
7B	Blue - 3		MOVE	MOVE	PM64	PM64	PE6	-	
8B	Purple - 3		ZONE1	MODES	PM128	PM128	ZONE1	ZONE1	
9B	Gray - 3		PZONE	PZONE	PZONE	PM256	PZONE	PZONE	
10B	White - 3		RMDS						
11B	Black - 3		HEND						
12B	Brown - 4		PEND	PEND/WND	PEND	PEND	PEND	-	
13B	Red - 4		SV						
14B	Orange - 4		*EMGS						
15B	Yellow - 4		*ALM						
16B	Green - 4		LOAD/TRQS	-	LOAD/TRQS	LOAD/TRQS	LOAD/TRQS	-	
17B	Blue - 4		(Not used)						
18B	Purple - 4		(Not used)						
19B	0V		White - 4	0V					
20B			Black - 4						

- Caution:
- [1] The signals indicated by \* in the table (\*ALM, \*STP and \*EMGS) are based on the negative logic, meaning that they remain ON in normal conditions of use.
  - [2] Do not connect pins denoted by “Not used” (orange-1, yellow-1, blue-4, purple-4, gray-4), but insulate them instead.
  - [3] The NPN and PNP specifications use the same power line configuration, so there is no need to reverse the power signal assignments for a PNP controller.
  - [4] The LOAD/TRQS signal is available only with the PCON-CF controller.

## 5.3 Details of I/O Signal Functions

An input time constant is provided for the input signals of this controller, in order to prevent malfunction due to chattering, noise, etc.

Except for certain signals, switching of each input signal will be effected when the signal has been received continuously for at least 6 msec. For example, when an input is switched from OFF to ON, the controller will only recognize that the input signal is ON after 6 msec. The same applies to switching of input signals from ON to OFF (Fig. 1).

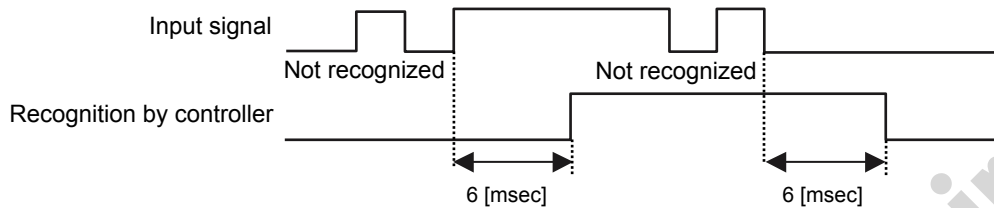

Fig. 1 Recognition of Input Signal

### 5.3.1. Details of Each Input Signal

#### ■ Operating mode (RMOD)

This controller has a mode selector switch on the front panel of the controller to prevent malfunction and data loss due to duplicate operations.

Normally this switch should be set to the "AUTO" position when the actuator is operated in the auto mode using I/O signals exchanged with a PLC, or to the "MANU" position when the actuator is operated manually using a PC or teaching pendant.

If the controller is mounted in a control panel, however, this switch is not readily accessible. Accordingly, a function has been added to allow the setting of this switch to be changed from a PLC for added convenience.

Specifically, the internal operating mode of the controller will become "AUTO" when this signal is turned OFF, or "MANU" when this signal is turned ON, if the mode selector switch is set to the "AUTO" position.

If the mode selector switch is set to the "MANU" position, the internal operating mode of the controller will remain "MANU" regardless of the status of this signal.

Use this signal in applications where the operation mode must be switched frequently between auto and manual and the selector switch is provided on the equipment side.

#### ■ Start (CSTR)

Upon detecting an OFF → ON rise edge of this signal, the controller will read, as a binary code, the target position number consisting of six bits from PC1 to PC32 (or eight bits from PC1 to PC128 when the PIO pattern is "256-point type," or nine bits from PC1 to PC256 when the PIO pattern is "512-point type"), and execute positioning to the target position of the corresponding position data.

Before executing this command, the target position, speed and other operation data must be set in the position table using a PC/teaching pendant.

If a start command is issued when home return operation has not been performed yet after the power was input (the HEND output signal is OFF), the controller will automatically perform home return operation before positioning to the target position.

#### ■ Command position number (PC1 to PC256)

When a movement command is effected upon OFF → ON of the start signal, the nine-bit binary code consisting of signals PC1 to PC256 will be read as the command position number.

In the standard or teaching type, six bits of PC1 through PC32 are used. In the 256-point type, eight bits of PC1 to PC128 are used. In the 512-point type, nine bits of PC1 through PC256 are used.

The weight of each bit is as follows:  $2^0$  for PC1,  $2^1$  for PC2,  $2^2$  for PC4, ..., and  $2^9$  for PC256. A desired position number between 0 and 511 (maximum) can be specified.



## ■ Pause (\*STP)

When this signal turns OFF while the actuator is moving, the actuator will decelerate to a stop. The remaining movement is retained and will be resumed when the signal is turned ON again. To abort the movement command, turn ON the alarm reset signal while this signal is OFF to cancel the remaining movement.

The \*STP signal can be used for the following purposes:

- [1] Provide a low-level safety measure to stop the axis while the servo is ON, such as a sensor that detects a person approaching the system
- [2] Prevent contact with other equipment
- [3] Perform positioning based on sensor or LS detection

(Note) If the \*STP signal is input while the actuator is performing home return, the movement command will be retained if the actuator is yet to contact a mechanical end. If the signal is input after the actuator has reversed upon contacting a mechanical end, home return will be performed again from the beginning.

## ■ Home return (HOME)

The controller will start home return operation upon detection of an OFF → ON edge of this signal. When the home return is complete, the HEND signal will be output. The HOME signal can be input as many times as required.

## ■ Servo ON (SON)

The servo remains ON while this signal is ON.

When the power is turned on, make sure this signal will turn ON after the safety of the entire equipment is ensured, i.e., after a confirmation that the actuator will not contact surrounding equipment. If the SON signal need not be used in view of the nature of the equipment, you can disable the signal using parameter No. 21.

When this signal is disabled, the servo will turn on automatically after the power is turned on. The factory setting is to enable the SON signal.

## ■ Alarm reset (RES)

This signal provides two functions.

- [1] Reset the alarm output signal (\*ALM) that turned OFF due to an alarm  
If an alarm has generated, turn ON this signal after confirming the nature of the alarm. The controller will reset the alarm upon detection of a rise edge of the RES signal.  
(Note) Certain alarms cannot be reset by the RES signal. For details, refer to 10, "Troubleshooting."
- [2] Cancel the remaining movement when the pause signal is OFF  
This function is used when the remaining movement must be cancelled to allow for incremental moves (movements at a constant increment) from the position where the actuator stopped following a sensor detection.

## ■ Brake release (BKRL)

When the actuator is equipped with a brake, you may want to forcibly release the brake in certain situations such as when starting up the system for the first time. Normally the brake release switch on the front panel of the controller is set to the "RLS" side to release the brake. For added convenience, the brake can now be released from the PLC.

If this signal is ON while the servo is off, the brake is released.

Use this signal to provide a release switch near the actuator when the actuator is located away from the controller.

## ■ Operation mode (MODE)

This signal is effective when the teaching type is selected.

When this signal is turned ON while the actuator is standing still, the normal operation mode will change to the teaching mode.

The controller will turn ON the MODES output signal upon receiving this signal.

Program the PLC so that it will accept a current-position write command after confirming that the MODES output signal is ON.

When this signal is turned OFF, the controller will return to the normal operation mode.

## ■ Current-position write (PWRT)

This signal is enabled when the aforementioned MODES output signal is ON.

When this signal has remained ON for 20 msec or longer, the controller will read the position number specified by a binary code consisting of PC1 through PC32 as currently detected, and write the current position data in the "Position" field of the corresponding position number.

If data of other items (speed, acceleration/deceleration, positioning band, etc.) are yet to be defined, the default settings of the corresponding parameters will be written.

When the writing completes successfully, the WEND output signal will turn ON.

Configure the system in such a way that the PLC will turn OFF the PWRT signal when WEND turns ON. The controller will turn OFF WEND once the PWRT signal turns OFF.

(Note) An alarm will generate if a write command is issued when home return has not been performed yet or while the actuator is moving.

## ■ Manual operation switching (JISL)

This signal is enabled when the teaching type is selected.

The JISL signal is used to switch operations in the manual mode. Specifically, the actuator will jog when this signal is OFF, or inch when this signal is ON.

If this signal is turned ON while the actuator is jogging, the actuator will decelerate to a stop.

If this signal is turned OFF while the actuator is inching, the actuator will continue with its inching movement.

## ■ Jog (JOG+, JOG-)

This signal is enabled when the teaching type is selected.

When the actuator is jogging (i.e., the JISL signal is OFF), it will jog toward the +/- software stroke limit upon detection of an OFF → ON rise edge of this signal.

If an ON → OFF fall edge of this signal is detected while the actuator is moving, the actuator will decelerate to a stop.

The jogging speed is defined by parameter No. 26, "PIO jog speed."

\* If any of the following input signal changes occurs while the actuator is jogging, the actuator will decelerate to a stop:

- [1] Both the JOG+ and JOG- signals have turned ON.
- [2] The JISL signal has turned ON (i.e., the operation mode has changed to inching).
- [3] The CSTR signal has turned ON (i.e., a positioning command has been input).

Upon detection of an OFF → ON rise edge of this signal while the actuator is inching (i.e., the JISL signal is ON), the actuator will travel the distance defined in parameter No. 48, "PIO inching distance."

The actuator will continue with its inching movement if this signal is switched while the actuator is inching.

 **Caution:** If jogging or inching is performed before a home return is completed, the actuator may collide with a mechanical end because the software stroke limits are not yet effective. Exercise due caution.

## ■ Direct position command (ST0 to ST6) [7-point type]

These signals are effective when "4" is set in parameter No. 25.

Upon detection of an OFF → ON rise edge of this signal or detection of the ON level of the signal, the actuator will move to the target position set in the corresponding position data.

Before executing this command, the target position, speed and other operation data must be set in the position table using a PC/teaching pendant.

If ON edges of two or more signals are detected at the same time, priority will be given to the position command of the smallest number among all detected command signals. (Example: If ON edges of ST0 and ST1 signals are detected at the same time, the actuator will start moving to position 0.)

Although commands are executed upon detection of an ON signal edge, priority is given to the command that was specified the earliest. In other words, a signal input will not be accepted while the actuator is moving. Even if a different position signal is turned ON while the actuator is moving, the actuator will not commence moving to the new position after reaching the target position.

Correspondence table of input signals and command positions

Input signal	Command position
ST0	Position No. 0
ST1	Position No. 1
ST2	Position No. 2
ST3	Position No. 3
ST4	Position No. 4
ST5	Position No. 5
ST6	Position No. 6

If a movement command is issued when the first home return is not yet completed after the power was input, home return will be performed automatically to establish the coordinates first, after which the actuator will move to the target position.

# P<sub>CON</sub>

---

---

■ Movement to each position (ST0 to ST2) [3-point type]

Since the number of positioning points is limited to three, the actuator can be controlled just like an air cylinder.

While this signal is ON, the actuator will move toward the target position.

If the signal turns OFF while the actuator is moving, the actuator will decelerate to a stop.

Before executing this command, enter a target position in the "Position" field for position No. 0, 1 or 2 in the position table.

Input signal	Target position	Remarks
ST0	Rear end	The target position is defined in the "Position" field for position No. 0.
ST1	Front end	The target position is defined in the "Position" field for position No. 1.
ST2	Intermediate point	The target position is defined in the "Position" field for position No. 2.

Air-Oil Systems, Inc. [www.airoil.com](http://www.airoil.com)

## 5.3.2 Details of Each Output Signal

### ■ Operating mode status (RMDS)

The internal operating mode of the controller is output based on the AUTO/MANU selector switch on the controller and the RMOD signal received by the input port. If the selector switch is set to "AUTO" and the RMOD signal is OFF (AUTO), the controller is in the AUTO (OFF) mode. If the selector switch is set to "MANU" and/or the RMOD signal is ON (MANU), the controller is in the MANU (ON) mode.

### ■ Completed position number (PM1 to PM256)

These signals can be used to check the completed position number when the PEND signal turns ON. The signals are output as a binary code.

Immediately after the power is input, all of the PM1 to PM256 signals are OFF.

In the standard or teaching type, six bits of PM1 through PM32 are used. In the 256-point type, eight bits of PM1 through PM128 are used. In the 512-point type, nine bits of PM1 through PM256 are used.

All of these signals are OFF also when the actuator is moving.

As described above, this signal is output only when positioning is completed.

(Note) All of these signals will turn OFF when the servo is turned OFF or an emergency stop is actuated. They will return to the ON status when the servo is turned ON again, provided that the current position is inside the in-position range with respect to the target position. If the current position is outside the range, the signals will remain OFF.

When the power is input, the PEND signal will turn ON. These signals are all OFF, this condition is the same as one achieved after positioning to position "0" is completed.

Check the position of position 0 after the movement command has completed.

If an alarm is present, the corresponding alarm code (abbreviated form) consisting of four bits from PM1 to PM8 will be output.

The meanings of these signals vary between the normal condition and the alarm condition, so be careful not to use them wrongly in the sequence.

### ■ Moving (MOVE)

This signal is output while the servo is ON and the actuator is moving (also during home return, push & hold operation or jogging).

Use the MOVE signal together with the PEND signal to allow the PLC to determine the actuator status.

The MOVE signal will turn OFF after positioning or home return is completed or a judgment is made during push & hold operation that the load is being contacted.

### ■ Position complete (PEND)

This signal indicates that the target position was reached and positioning has completed.

Use the PEND signal together with the MOVE signal to allow the PLC to determine the positioning status.

When the controller becomes ready after the power was input and the servo has turned ON, this signal will turn ON if the position deviation is within the in-position range.

Then, when a movement command is issued by turning ON the start signal, the PEND signal will turn OFF. It will turn ON again when the deviation from the target position falls within the in-position range.

Once turned ON, the PEND signal will not turn OFF even when the position deviation subsequently exceeds the in-position range.

(Note) If the start signal remains ON, the PEND signal will not turn OFF even when the deviation from the target position falls within the in-position range: it will turn ON when the start signal turns OFF.

Even when the motor is stopped, the PEND signal will remain OFF if the pause signal is input or the servo is OFF.

## ■ Home return completion (HEND)

This signal is OFF immediately after the power is input, and turns ON in either of the following two conditions:

[1] Home return operation has completed with respect to the first movement command issued with the start signal.

[2] Home return operation has completed following an input of the home return signal.

Once turned ON, the HEND signal will not turn OFF unless the input power supply is cut off, a soft reset is executed, or the home return signal is input again.

The HEND signal can be used for the following purposes:

[1] Check prior to establishing the home if movement toward the home direction is permitted, in cases where an obstacle is located in the direction of the home

[2] Use as a condition for writing the current position in the teaching mode

[3] Use as a condition for enabling the zone output signal

## ■ Zone (ZONE1, ZONE2)

[1] ZONE1

This signal will remain ON while the current actuator position is inside the zone specified by Parameter No. 1, "Zone boundary+" and Parameter No. 2, "Zone boundary-," or OFF while the actuator is outside this range. This signal is always effective once home return has been completed and is not affected by the servo status or presence of an alarm.

(Note) This signal becomes effective only after the coordinate system has been established following a completion of home return. It will not be output immediately after the power is turned on.

[2] PZONE

This signal will turn ON when the current actuator position enters the area between the zone boundaries set in the position table. After the current position movement command is completed, the signal will remain effective until the next position movement command is received.

## ■ Current operation mode (MODES)

This signal is enabled when the teaching type is selected.

The MODES signal will turn ON when the teaching mode is enabled upon selection of the teaching mode via the operation mode input signal (MODE signal ON).

Thereafter, the MODES signal will remain ON until the MODE signal turns OFF.

Configure the system in such a way that the PLC will start teaching operation after confirming that the MODES signal has turned ON.

## ■ Write completion (WEND)

This signal is enabled only when the teaching type is selected.

The WEND signal is OFF immediately after the controller has switched to the teaching mode. It will turn ON when the writing of position data in response to the current-position write signal is completed.

When the current-position write signal turns OFF, this signal will also turn OFF.

Configure the system in such a way that the PLC will acknowledge completion of writing when the WEND signal turns OFF.

■ Movement complete at each position (PE0 to PE6) [7-point type]

When PIO pattern is “4,” a position number (0 through 6) corresponding to each movement command will be output upon completion of positioning. Simple alarm-code output function is not provided for these signals. If an alarm generates, only the \*ALM signal will turn OFF. Check the details of the alarm code using each tool.

Correspondence table of output signals and positions completed

Output signal	Position completed
PE0	Position No. 0
PE1	Position No. 1
PE2	Position No. 2
PE3	Position No. 3
PE4	Position No. 4
PE5	Position No. 5
PE6	Position No. 6

Note) These signals turn OFF when the servo is turned OFF or an emergency stop is actuated. They will return to the ON status when the servo is turned ON again, provided that the current position is inside the in-position range with respect to the target position. If the current position is outside the range, the signals will remain OFF.

■ Position detection output at each position (LS0 to LS2) [3-point type]

These signals have the same meanings as the LS signals of an air cylinder. Each signal will turn ON when the current position enters the positioning band of the target position.

(Note) Even if the servo turns off or an emergency stop is actuated while the actuator is stopped at the target position, the signal will remain ON as long as the actuator is inside the positioning band.

Output signal	Position detected	Remarks
ST0	Rear end	The detection position is defined in the “Position” and “Positioning band” fields for position No. 0.
ST1	Front end	The detection position is defined in the “Position” and “Positioning band” fields for position No. 1.
ST2	Intermediate point	The detection position is defined in the “Position” and “Positioning band” fields for position No. 2.

■ Ready (SV)

This is a monitor signal indicating that the servo is ON and the motor is ready. Use this signal as a condition for starting a movement command on the PLC side.

■ Alarm (\*ALM)

This signal remains ON while the controller is operating properly, and turns OFF when an alarm has generated.

Provide an appropriate safety measure for the entire system by allowing the PLC to monitor the OFF status of this signal.

For details of alarms, refer to 10, “Troubleshooting.”

## ■ Emergency stop (\*EMGS)

This signal remains ON while the controller is normal, and will turn OFF if the emergency stop circuit is cut off.

Program the PLC so that it will monitor this signal and implement appropriate safety measures for the entire system if the signal turns OFF.

## ■ Load output judgment status (LOAD) \* This is a dedicated signal available only with the PCON-CF.

If used in a press-fitting application, the controller must be able to know if the specified load threshold was reached during push & hold operation.

A desired load threshold and check band range are set in the position table, and this signal will turn ON when the command torque exceeds the threshold while the actuator is inside the check band range.

With the LOAD signal, judgment is made based on whether the total duration of periods in which the command torque has exceeded the threshold corresponds at least to a specified time. The specific processing procedure is the same as the one used when determining a completion of push action. The time used for judgment of load output can be changed freely using user parameter No. 50, "Load output judgment time."

## ■ Torque level status (TRQS) \* This is a dedicated signal available only with the PCON-CF.

If a load threshold is set, this signal will turn ON when the motor current reaches the load threshold while the actuator is moving.

Since the level of current is monitored, the ON/OFF status of this signal will change when the current changes.

In the weak field-magnet vector control used for stepping motors, the balance of current and torque will be lost once a specific speed is exceeded. To use the command current to determine if the threshold has been reached, therefore, the push speed must be limited. Note, however, that the range of permissible push speeds varies depending on the motor and lead, which means that the push speed set in user parameter No. 34 must also be adjusted according to the applicable motor and lead.

## ■ Output Signal Changes in Each Mode

Mode classification	MOVE	PEND	SV	HEND	PM1 ~ PM256
Actuator is stopped with the servo ON after the power was input	OFF	ON	ON	OFF	OFF
Home return is in progress following an input of the home return signal	ON	OFF	ON	OFF	OFF
Home return has completed following an input of the home return signal	OFF	ON	ON	ON	OFF
Actuator is moving in the positioning/push & hold mode	ON	OFF	ON	ON	OFF
Actuator is paused in the positioning/push & hold mode	OFF	OFF	ON	ON	OFF
Positioning has completed in the positioning mode	OFF	ON	ON	ON	ON
Actuator has stopped after contacting the load in the push & hold mode	OFF	ON	ON	ON	ON
Actuator has stopped after missing the load (no load) in the push & hold mode	OFF	OFF	ON	ON	ON
Actuator is stopped with the servo ON in the teaching mode	OFF	/	ON	ON	/
Actuator is jogging in the teaching mode	ON		ON	ON	
Actuator is being moved by hand with the servo OFF in the teaching mode	OFF		OFF	ON	
Servo is OFF after home return	OFF	OFF	OFF	ON	OFF
Emergency stop has been actuated after home return	OFF	OFF	OFF	ON	

(Note) Determine whether the actuator has stopped after contacting the load or missing the load from the signal statuses of MOVE, PEND and PM1 to PM256.



## 6. Data Entry <Basics>

To move the actuator to a specified position, a target position must be entered in the “Position” field. A target position can be specified in the absolute mode where a distance from the home is entered, or in the incremental mode where a relative travel from the current position is entered.

Once a target position is entered, all other fields will be automatically populated with their default values set by the applicable parameters.

The default values vary depending on the characteristics of the actuator.

### 6.1 Description of Position Table

The position table is explained using an example on the PC software screen. (The items displayed on the teaching pendant are different.)

No.	Position [mm]	Speed [mm/s]	Acceleration [G]	Deceleration [G]	Push [%]	Threshold [%]	Positioning band [mm]
0	5.00	300.00	0.30	0.30	0	0	0.10
1	380.00	300.00	0.30	0.10	0	0	0.10
2	200.00	300.00	0.30	0.10	0	0	0.10

Zone+ [mm]	Zone- [mm]	Acceleration/ deceleration mode	Incremental	Command mode	Standstill mode	Comment
100.00	0.00	0	0	0	4	Standby position
400.00	300.00	0	0	0	0	
250.00	150.00	0	0	0	0	

- (1) No.
  - Indicate the position data number.
- (2) Position
  - Enter the target position to move the actuator to, in [mm].

Absolute mode: Enter a distance from the actuator home.

Incremental mode: Enter a relative travel from the current position based on constant-pitch feed.

No	Position [mm]
0	30.00
1 =	10.00
2 =	-10.00

Absolute mode The target position is 30 mm from the home.

Incremental mode +10 mm from the current position

Incremental mode -10 mm from the current position

\* On the teaching pendant, this sign indicates that the position is set in the incremental mode.

- (3) Speed
  - Enter the speed at which the actuator will be moved, in [mm/sec].

The default value varies depending on the actuator type.

- (4) Acceleration/deceleration
- Enter the acceleration/deceleration at which to move the actuator, in [G].  
Basically, the acceleration and deceleration should be inside the rated acceleration/deceleration range specified in the catalog.  
The input range is greater than the rated range in the catalog to accommodate situations where you want to “reduce the tact time when the load mass is significantly smaller than the rated load capacity.”  
If vibration of the load causes problem during acceleration/deceleration, decrease the set value.

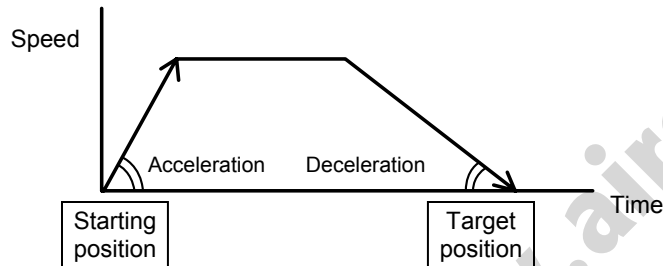

Increasing the set value makes the acceleration/deceleration quicker while decreasing the value makes it more gradual.

**⚠ Caution:** Refer to the attached list of supported actuator specifications and set appropriate speed and acceleration/deceleration so that the actuator will not receive excessive impact or vibration under the applicable installation condition and for the load of the specific shape. Increasing the speed and acceleration/deceleration may significantly impact the actuator depending on the load mass, and the actuator characteristics also vary from one model to another. Contact IAI for the maximum limits that can be entered in your specific application.

- (5) Push
- Select “positioning operation” or “push & hold operation.”  
The factory setting is “0.”  
0: Normal positioning operation  
Other than 0: Push & hold operation, where the entry indicates a current-limiting value.
- (6) Threshold
- This field sets the threshold for motor current. The factory setting is “0.”  
\* This field is available only with the PCON-CF controller.
- (7) Positioning band
- The meaning of this field varies between “positioning operation” and “push & hold operation.”

“Positioning operation”  
This field defines how much before the target position the completion signal will turn ON.  
Increasing the positioning band allows the next operation in the sequence to be started early, and consequently the tact time can be reduced. Set an optimal value by checking the overall balance of the system.

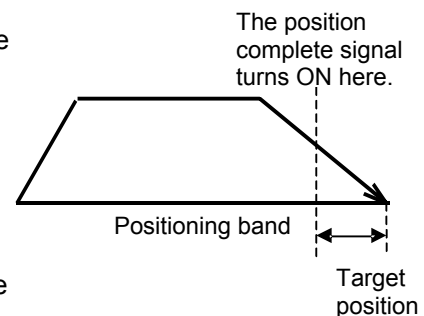

### “Push & hold operation”

This field defines the maximum push distance after reaching the target position in push & hold operation.

Consider possible mechanical variation of the load and set an appropriate positioning band that will prevent the positioning from completing before the load is contacted.

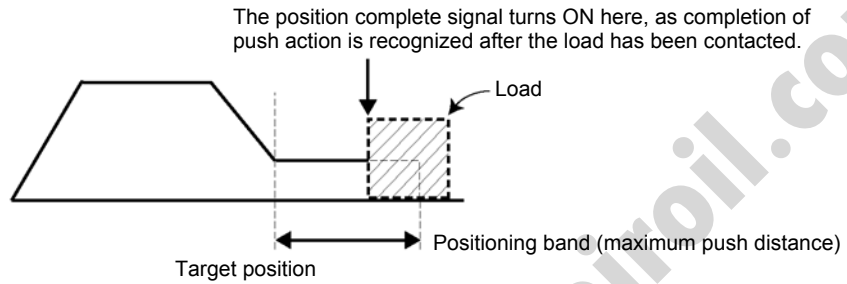

### (8) Zone +/-

- This field defines the zone within which the position zone output signal (PZONE) will turn ON. To add flexibility, a different zone can now be set for each target position.

[Setting example]

No.	Position [mm]	Zone+ [mm]	Zone- [mm]
0	5.00	100.00	0.00
1	380.00	400.00	300.00
2	200.00	250.00	150.00

#### Movement command to position No. 0

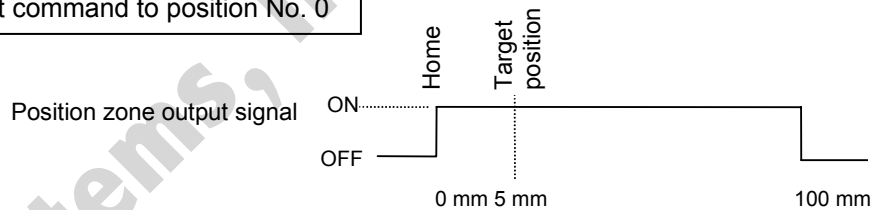

#### Movement command to position No. 1

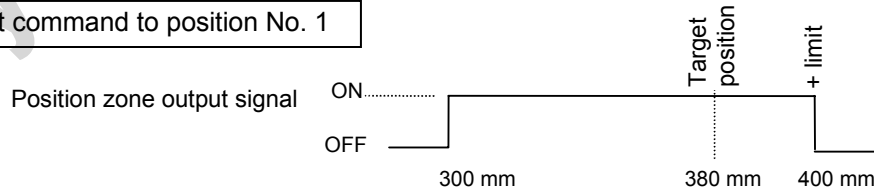

#### Movement command to position No. 2

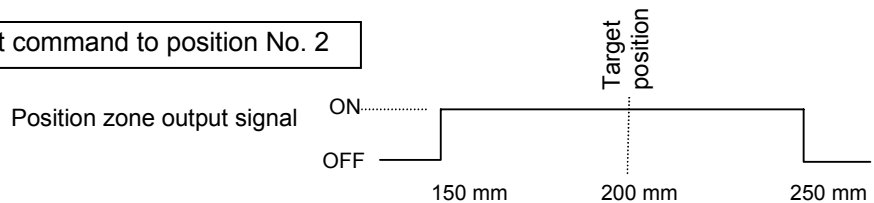

- (9) Acceleration/deceleration mode
  - This field is not used for this controller. The factory setting is "0."
- (10) Incremental
  - This field defines whether the position is specified in the absolute mode or incremental mode. The factory setting is "0."
  - 0: Absolute mode
  - 1: Incremental mode
- (11) Command mode
  - This field is not used for this controller. The factory setting is "0."
- (12) Standstill mode
  - This field defines the power-saving mode to be applied while the actuator is standing by after completing its movement to the target position set in the "Position" field for the applicable position number.
    - 0: Disable all power-saving modes \* The factory setting is "0" (Disable).
    - 1: Automatic servo-off mode, with the delay time defined by parameter No. 36
    - 2: Automatic servo-off mode, with the delay time defined by parameter No. 37
    - 3: Automatic servo-off mode, with the delay time defined by parameter No. 38
    - 4: Full servo control mode

### Full servo control mode

Holding current can be reduced by servo-controlling the pulse motor. Although the exact level of current reduction varies depending on the actuator model, load condition, etc., the holding current will decrease by approx. 1/2 to 1/4. Since the servo remains on, position deviation will not occur. The actual holding current can be checked in the current monitor screen of the PC software.

### Automatic servo-off mode

After positioning is completed, the servo will turn off automatically upon elapse of a specified time. (Since no holding current generates, power consumption will decrease.) When the next movement command is received from the PLC, the servo will turn on and the actuator will start moving.

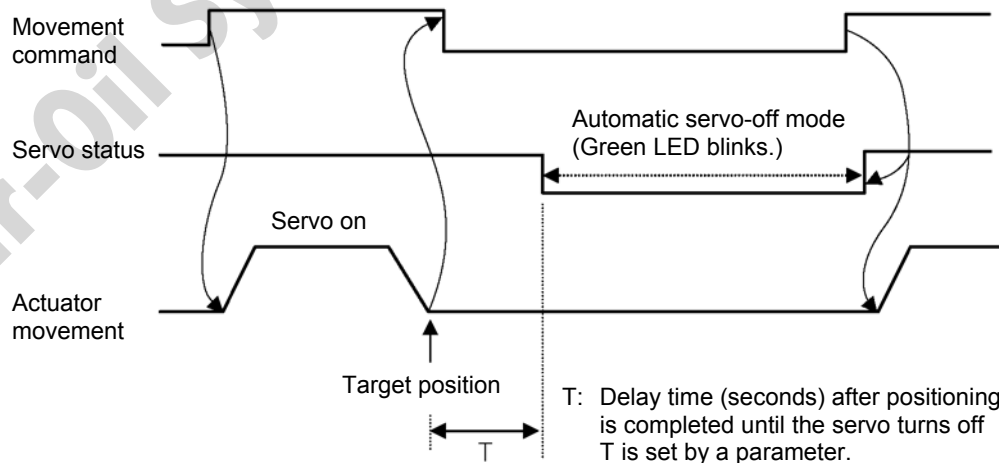

## 6.1.1 Relationship of Push Force at Standstill and Current-Limiting Value

When performing operation in the push & hold mode, enter the current-limiting value (%) in the push column of the position-data table.

Determine the current-limiting value (%) from the push force to be applied to the load at standstill.

The graphs below illustrate the relationship of push force at standstill and current-limiting value for each actuator type:

- Slider type

(1) SA5C/SA6C/SS7C type

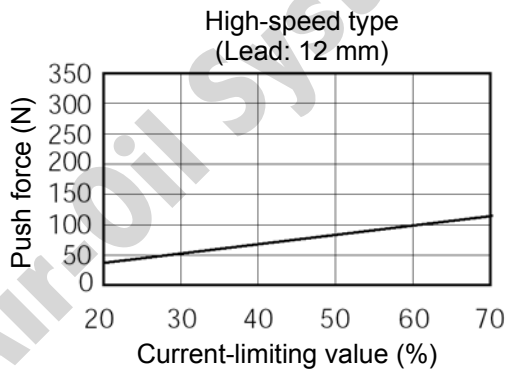
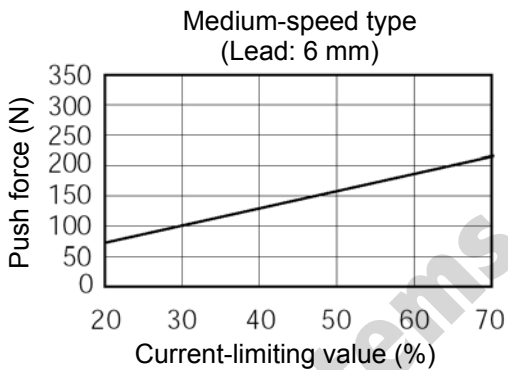
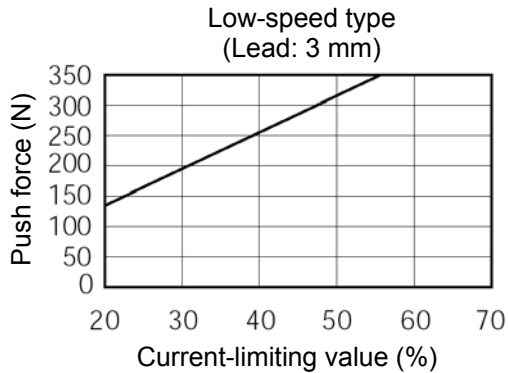

(2) SA7C type

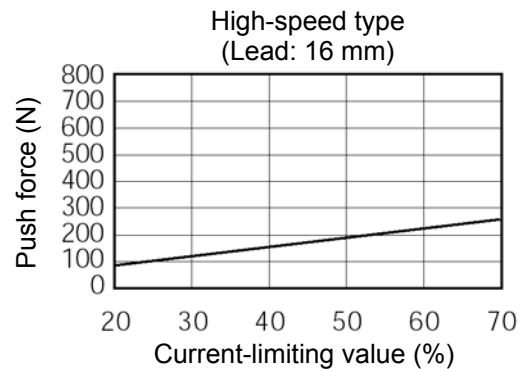
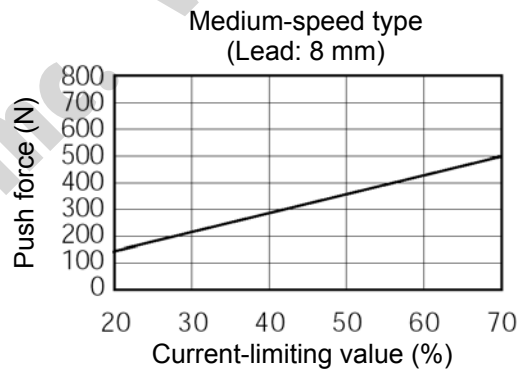
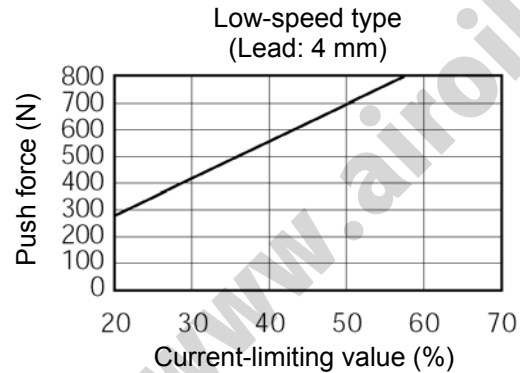

⚠ Caution: The accuracy of push force at standstill is not guaranteed. The above graphs are provided for reference purposes only. If the push force is too small, malfunction may occur during push & hold operation due to slide resistance, etc., so exercise caution. The maximum current-limiting value is shown in the above graphs. The minimum value is 20%.

(3) SS8C type

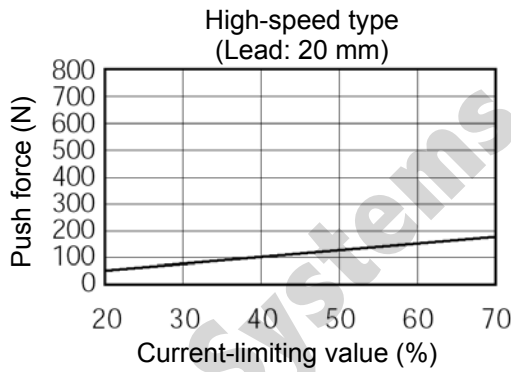
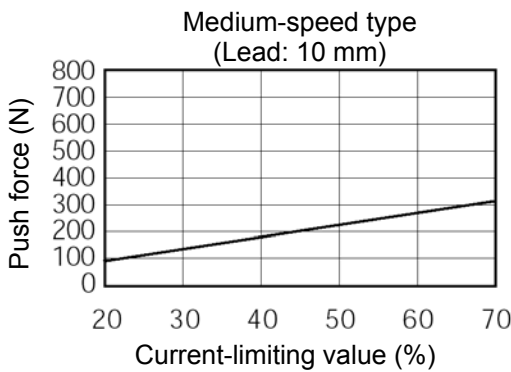
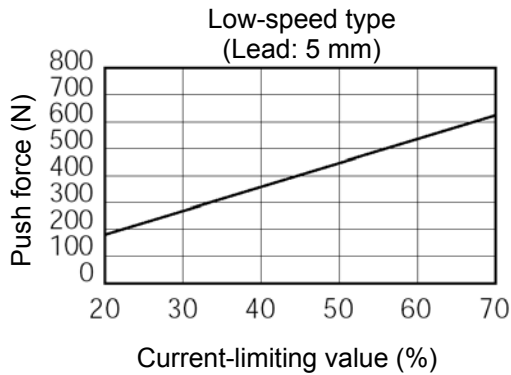

⚠ Caution: The accuracy of push force at standstill is not guaranteed. The above graphs are provided for reference purposes only. If the push force is too small, malfunction may occur during push & hold operation due to slide resistance, etc., so exercise caution. The maximum current-limiting value is shown in the above graphs. The minimum value is 20%.

● Rod type

(1) RA2C type

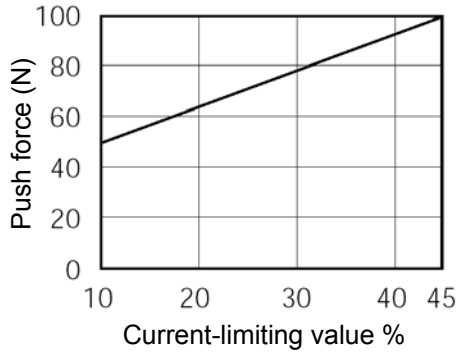

(2) RA3C type

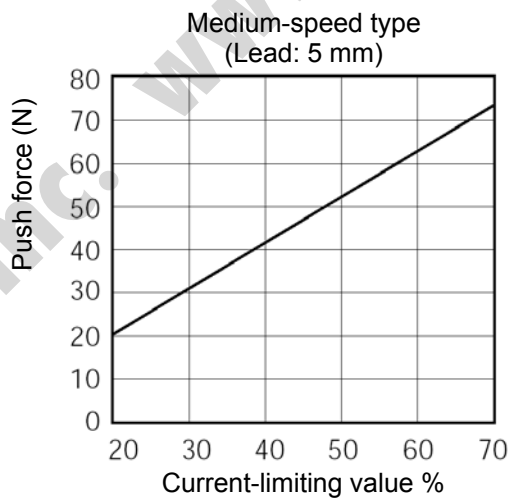
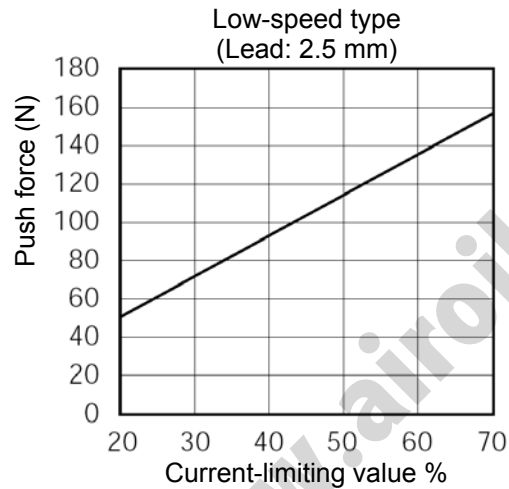

⚠ Caution: The accuracy of push force at standstill is not guaranteed. The above graphs are provided for reference purposes only. If the push force is too small, malfunction may occur during push & hold operation due to slide resistance, etc., so exercise caution. The maximum current-limiting value is shown in the above graphs. The minimum value is 20%.

(3) RA4C type

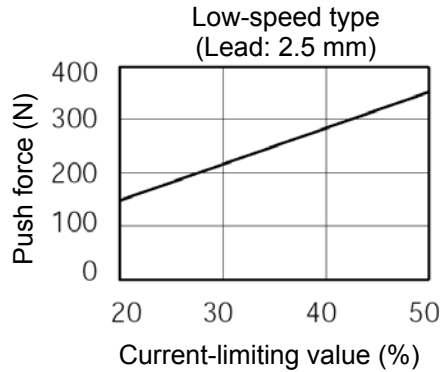

(4) RA6C type

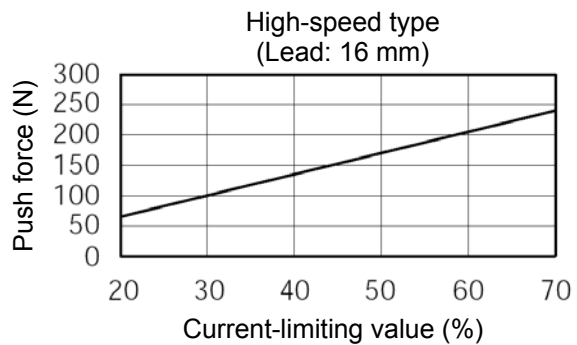
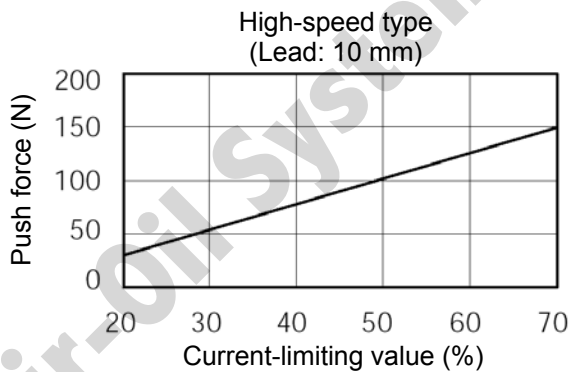
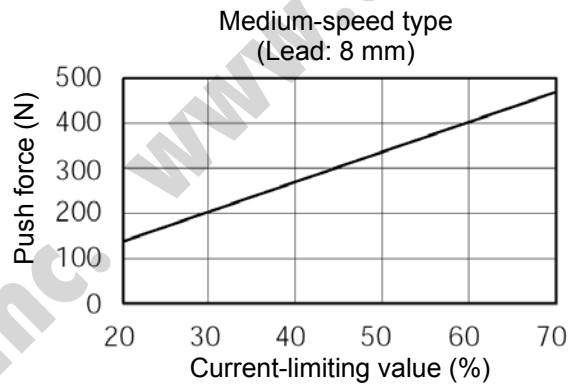
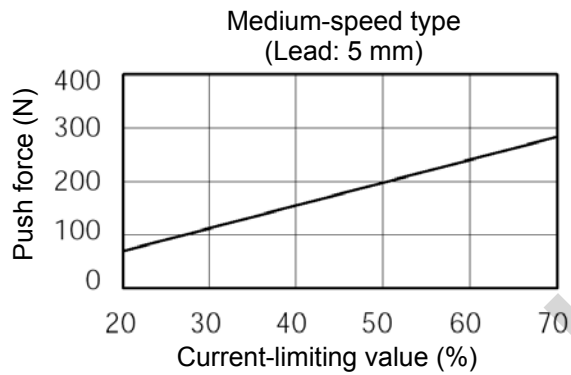
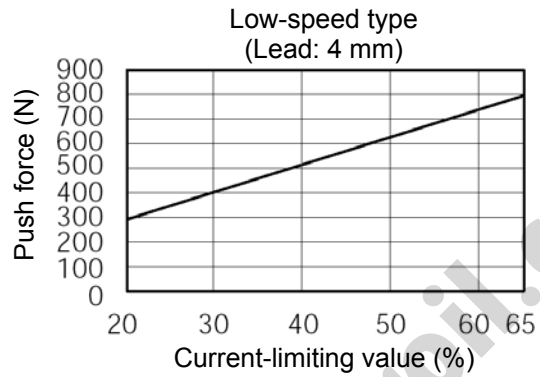

⚠ Caution: The accuracy of push force at standstill is not guaranteed. The above graphs are provided for reference purposes only. If the push force is too small, malfunction may occur during push & hold operation due to slide resistance, etc., so exercise caution. The maximum current-limiting value is shown in the above graphs. The minimum value is 20%.



(5) RA10C/W-RA10C type

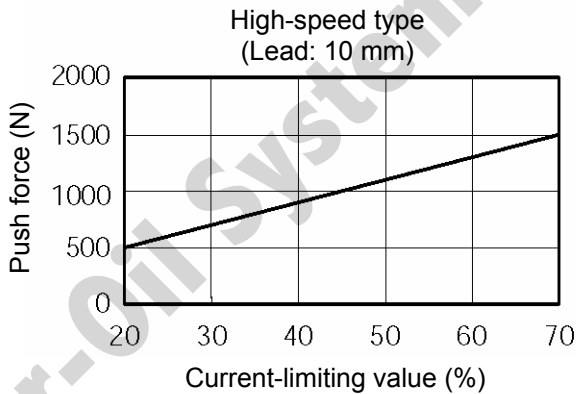
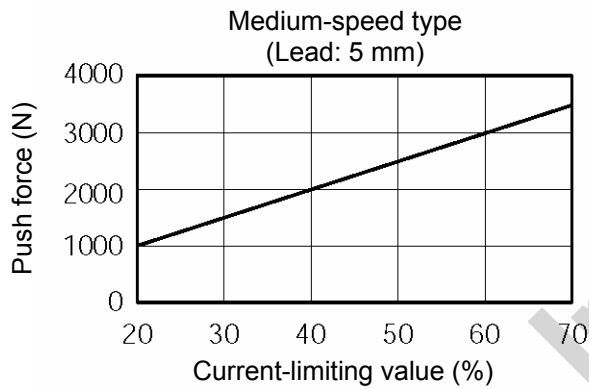
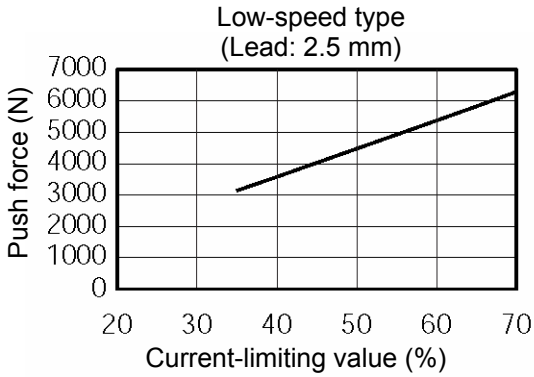

⚠ Caution: The accuracy of push force at standstill is not guaranteed. The above graphs are provided for reference purposes only. If the push force is too small, malfunction may occur during push & hold operation due to slide resistance, etc., so exercise caution. The maximum current-limiting value is shown in the above graphs. The minimum value is 20%.

## 6.2 Explanation of Modes

### 6.2.1 Positioning Mode Push = 0

The actuator moves to the target position set in the “Position” field of the position table.

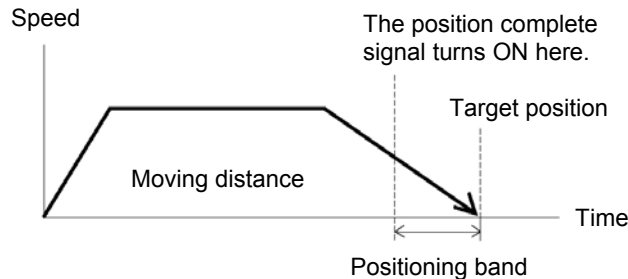

### 6.2.2 Push & Hold Mode Push = Other than 0

#### (1) Load was contacted successfully

Upon reaching the target position set in the “Position” field of the position table, the actuator moves at the push speed for the distance set in the “Positioning band” field.

If the actuator contacts the load while moving and the controller recognizes that “push action has completed,” the position complete signal will turn ON.

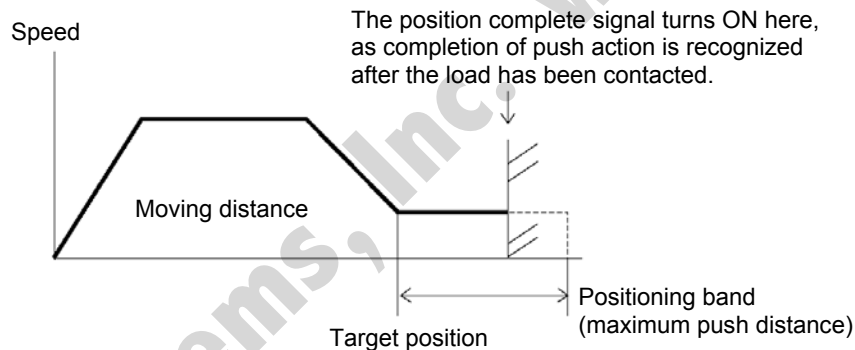

- The push speed is set by parameter No. 34. The factory setting varies with each actuator in accordance with the actuator’s characteristics. Set an appropriate speed by considering the material and shape of the load, among others. Since the maximum speed is 20 mm/s, operate the actuator at a speed not exceeding this value.
- Set a positioning band slightly longer than the last position, in order to absorb possible mechanical variation of the load.
- “Completion of push action” is determined based on a combination of the current-limiting value set in the “Push” field of the position table and the push completion judgment time set by parameter No. 6. Set an appropriate condition by considering the material and shape of the load, among others. For details, refer to Chapter 8, “Parameter Settings.”

#### Warning

- If the actuator contacts the load before reaching the target position, a servo error alarm will generate. Pay due attention to the relationship of the target position and the load position.
- The actuator continues to push the load at the push force at standstill determined by the current-limiting value. Since the actuator is not inactive, exercise due caution when handling the machine in this condition.

(2) Load was not contacted (missed)

If the actuator does not still contact the load after having moved the distance specified in the “Positioning band” field, the position complete signal will not turn ON.

Therefore, include timeout check processing in the sequence circuit on the PLC side.

- It is recommended that a zone signal be also used as a “simple ruler” to supplement the judgment of missed load.

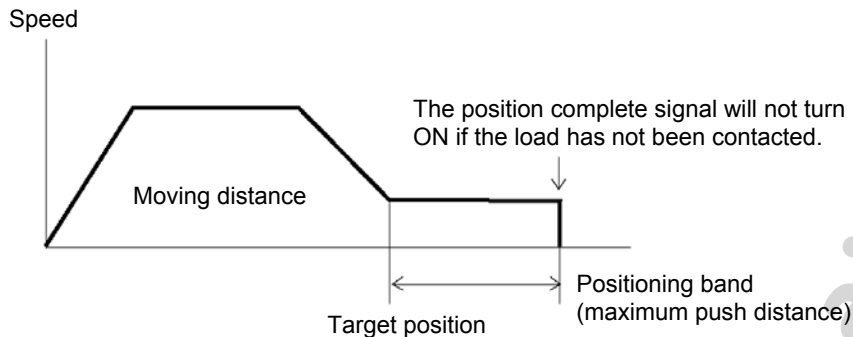

(3) Load moves during push & hold operation

[1] Load moves in the pushed direction

If the load moves in the pushed direction after completion of push action, the actuator will chase the load within the positioning band.

If the current drops to below the current-limiting value set in the “Push” field of the position table while the actuator is moving, the position complete signal will turn OFF. The position complete signal will turn ON when the current-limiting value increases to the specified level again.

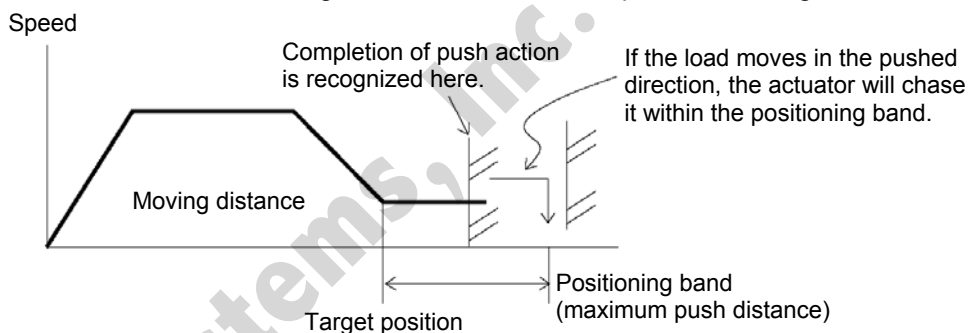

[2] Load moves in the opposite direction

(Actuator is pushed back by the strong reactive force of the load)

If the actuator is pushed back after completion of push action because the reactive force of the load is greater than the thrust force of the actuator, the actuator will be pushed back until its push force balances out with the reactive force of the load.

The position complete signal will remain ON.

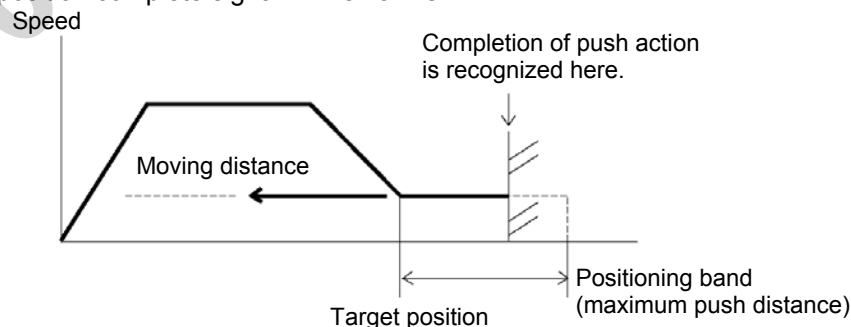

(Note) If the actuator is pushed back to the target position, an alarm will generate.

#### (4) Positioning band was entered with a wrong sign

Take note that if a value with a wrong sign is set in the “Positioning band” field of the position table, the operation will deviate by a distance corresponding to “positioning band x 2,” as shown below.

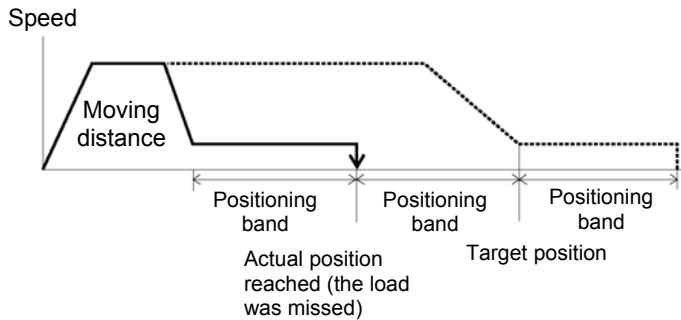

### 6.2.3 Torque Check Function in Push & Hold Operation

#### (1) Torque check function when a check band is set (Available only with the PCON-CF)

The position complete signal turns ON here, as completion of push action is recognized after the load has been contacted.

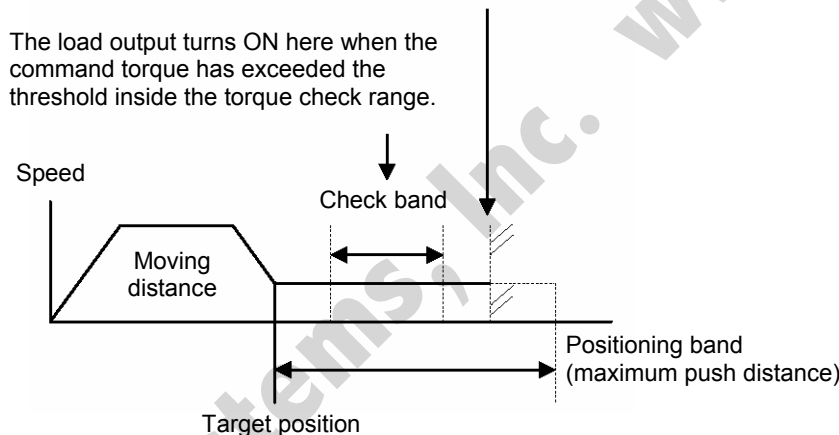

After reaching the target position set in the “Position” field of the position table, the actuator moves at the push speed by the distance set in the “Positioning band” field. If the command torque reaches the threshold before the specified distance is traveled and while the actuator is inside the threshold check band, the load output will turn ON.

- The push speed is set by parameter No. 34, “Push speed.”  
The factory setting varies with each actuator in accordance with the characteristics of the actuator. Set an appropriate speed by considering the material and shape of the load, among others. Take note, however, that the maximum speed is limited to 10 mm/s.
  - Set parameter No. 51, “Torque check range” to “0 [Enable].”
  - Set a threshold check band in the “zone + or zone -” field of the position table.
  - Set a desired threshold in the “Threshold” field of the position table.
  - Set a desired positioning band in the “Positioning band” field of the position table.  
Set a positioning band slightly longer than the last position, in order to absorb possible mechanical variation of the load.
- For details, refer to Chapter 8, “Parameter Settings.”

## Warning

- This function is available only with the PCON-CF controller. (It cannot be used with the PCON-C or PCON-CG controller.)
- If the actuator contacts the load before reaching the target position, a servo error alarm will generate. Pay due attention to the relationship of the target position and the load position.
- The actuator continues to push the load at the push force at standstill determined by the current-limiting value. Since the actuator is not inactive, exercise due caution when handling the equipment in this condition.

(2) Torque check function when a check band is not used (Available only with the PCON-CF)

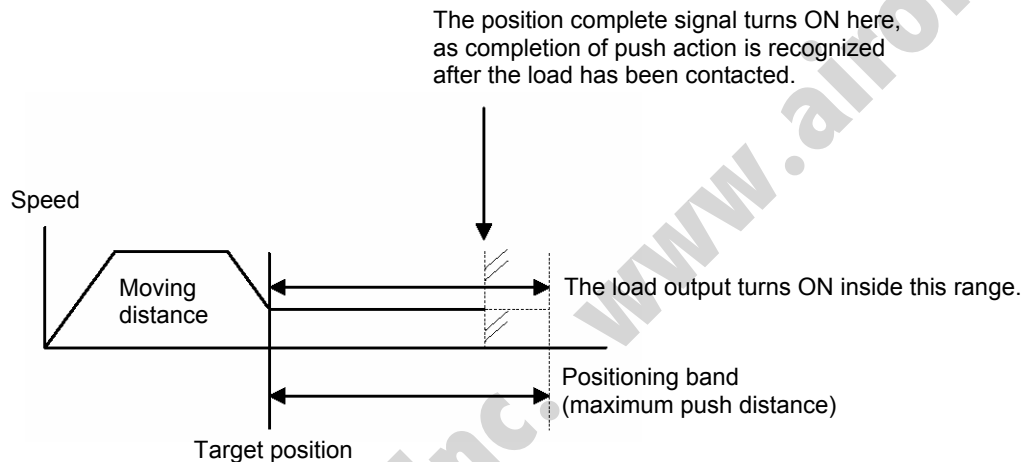

After reaching the target position set in the “Position” field of the position table, the actuator moves at the push speed by the distance set in the “Positioning band” field. If the command torque reaches the threshold before the end of the positioning band is reached, the load output will turn ON. The load output will turn OFF once the command torque drops to below the threshold.

- The push speed is set by parameter No. 34, “Push speed.”  
The factory setting varies with each actuator in accordance with the characteristics of the actuator. Set an appropriate speed by considering the material and shape of the load, among others. Take note, however, that the maximum speed is limited to 10 mm/s.
  - Set parameter No. 51, “Torque check range” to “1 [Disable].”
  - Set a desired threshold in the “Threshold” field of the position table.
  - Set a desired positioning band in the “Positioning band” field of the position table.  
Set a positioning band slightly longer than the last position, in order to absorb possible mechanical variation of the load.
- For details, refer to Chapter 8, “Parameter Settings.”

## Warning

- This function is available only with the PCON-CF controller. (It cannot be used with the PCON-C or PCON-CG controller.)
- If the actuator contacts the load before reaching the target position, a servo error alarm will generate. Pay due attention to the relationship of the target position and the load position.
- The actuator continues to push the load at the push force at standstill determined by the current-limiting value. Since the actuator is not inactive, exercise due caution when handling the equipment in this condition.

## 6.2.4 Speed Change during Movement

Speed control involving multiple speed levels is possible in a single operation. The actuator speed can be decreased or increased at a certain point during movement. However, the position at which to implement each speed change must be set.

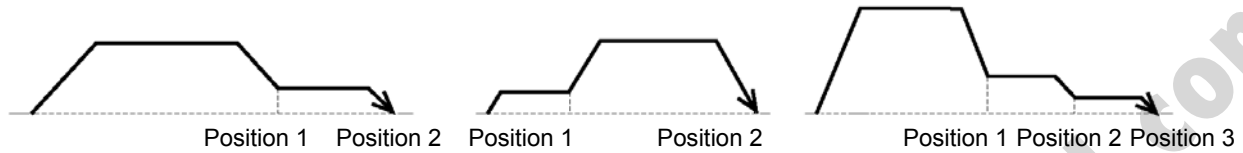

## 6.2.5 Operation at Different Acceleration and Deceleration Settings

If the load is a CCD camera or other precision equipment, the deceleration curb at stop must be made as gradual as possible.

To accommodate these sensitive applications, the position table has separate fields for “acceleration” and “deceleration.”

For example, you can set the deceleration differently from the acceleration, such as setting 0.3 G (rated acceleration) in “Acceleration” and 0.1 G in “Deceleration.”

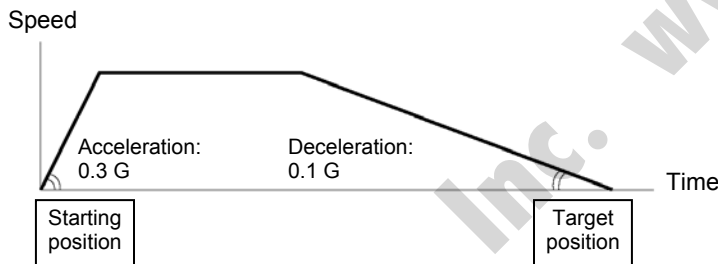

**Caution:** Basically, the acceleration and deceleration should be inside the rated acceleration/deceleration range specified in the catalog. The input range is greater than the rated range in the catalog, but this is only to accommodate situations where you want to “reduce the tact time when the load mass is significantly smaller than the rated load capacity.” If you want to use acceleration/deceleration settings greater than the rating, consult IAI beforehand because it may affect the life of the actuator.

## 6.2.6 Pause

The actuator can be paused during movement using an external input signal (\*STP). The pause signal uses the contact b logic (always ON) to ensure safety. Turning the \*STP signal OFF causes the actuator to decelerate to a stop. When \*STP is turned ON subsequently, the actuator will resume the remaining movement.

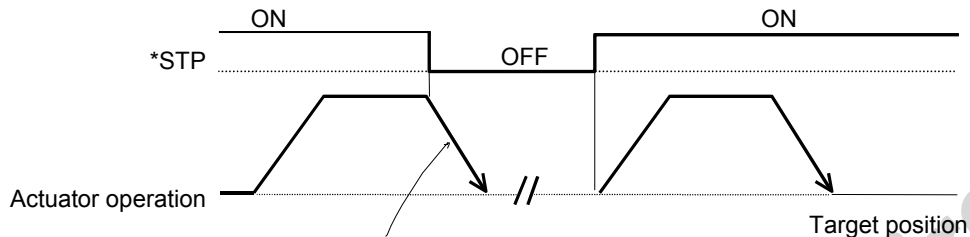

(Note) The deceleration corresponds to the value set in the “Deceleration” field for the current position number in the position table.

## 6.2.7 Zone Signal Output

The zone output is suitable for the following applications, because a signal can be output when the actuator enters a specified zone during movement:

- [1] Issue a trigger signal to surrounding equipment to reduce the tact time
- [2] Prevent contact with surrounding equipment
- [3] Use as a “simple ruler” in push & hold operation

A different method is used for the zone output signal, and for the position zone output signal, to set the zone within which the signal will turn ON.

### ■ Zone output signal (ZONE1)

Set the signal ON zone using parameters.

Parameter No. 1 = Zone boundary+, Parameter No. 2 = Zone boundary-

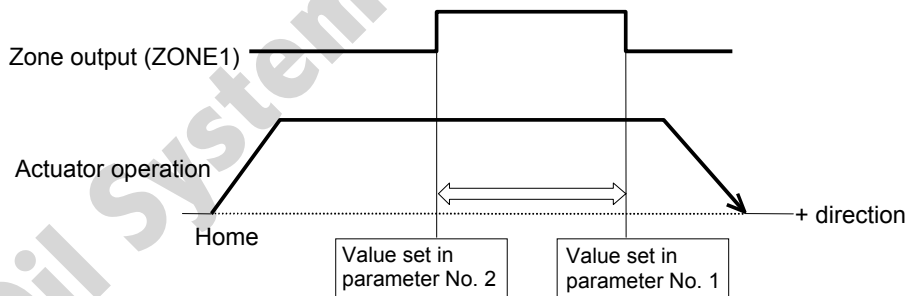

### ■ Position zone output signal (PZONE)

Set the signal ON zone using the “Zone boundary-“ and “Zone boundary+“ fields of the position table.

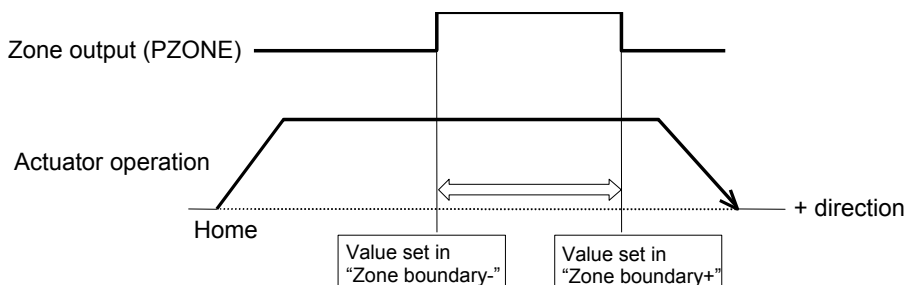

## 6.2.8 Home Return

After the power is turned on, home return must be performed to establish the home position.

The method of home return varies depending on the PIO pattern.

- When a dedicated input is used [PIO pattern  $\neq$  5]  
Home return is performed using the home return (HOME) input.  
The actuator will return home regardless of whether or not home return has been completed once before.  
When home return is completed, the home return complete (HEND) output signal will turn ON.
  - When a dedicated input is not used [PIO pattern = 5]  
When a rear end move command is input while home return is not yet completed, the actuator will perform home return first and then move to the rear end.
- ★ For details, refer to 7.2, "How to Execute Home Return."



## 6.2.9 Overview of Teaching Type

Depending on your system, it may be desirable to be able to use a touch panel, etc., to perform jogging operation or write the current position to the “Position” field of the position table, without using a PC or teaching pendant.

The teaching type is provided to support these applications.

The features of the teaching type are summarized below:

- [1] The actuator can be jogged using I/O signals input from the PLC.  
Continuous jog feed or inching feed can be selected by the manual switching signal to facilitate fine position adjustment.
  - \* This function is effective regardless of the ON/OFF state of the operation mode input (MODE) signal.
- [2] The current position can be written to the “Position” field of the position table using I/O signals input from the PLC.
  - \* This function is effective only when the operation mode input (MODE) signal is ON.

(Note) The number of I/O points is limited, so some I/O ports are used in both the teaching type and the normal positioning type. Remember this when creating a sequence circuit for the PLC.

Operation mode input (MODE) * Signal for switching to the teaching mode	ON (teaching mode)	OFF (positioning mode)
Current operation mode output (MODES) * Monitor output indicating the internal mode of the controller	ON (teaching mode)	OFF (positioning mode)
Meaning of I/O connector pin 18A	Current-position write input (PWRT)	Start input (CSTR)
Meaning of I/O connector pin 12B	Write completion output (WEND)	Position complete output (PEND)

**Warning:** Jog commands are effective even before home return is completed, but the soft stroke checks are not performed prior to home return. Accordingly, the actuator may move all the way to the mechanical end if the jog command (JOG+/JOG-) signal remains ON. Exercise caution not to let the actuator hit the mechanical end.

## 6.2.10 Overview of 7-point Type

The number of positioning points is kept small, or specifically to seven or less. This type assumes simple applications where the PLC ladder sequence only requires a simple circuit configuration. I/O signals provide separate command inputs and movement complete outputs for respective position numbers.

Accordingly, the signal pattern is different from the one in the 64-point positioning type (PIO pattern = 0).

Example) The differences are explained by using an example of moving the actuator to the target position for position No. 5.

[1] 7-point type

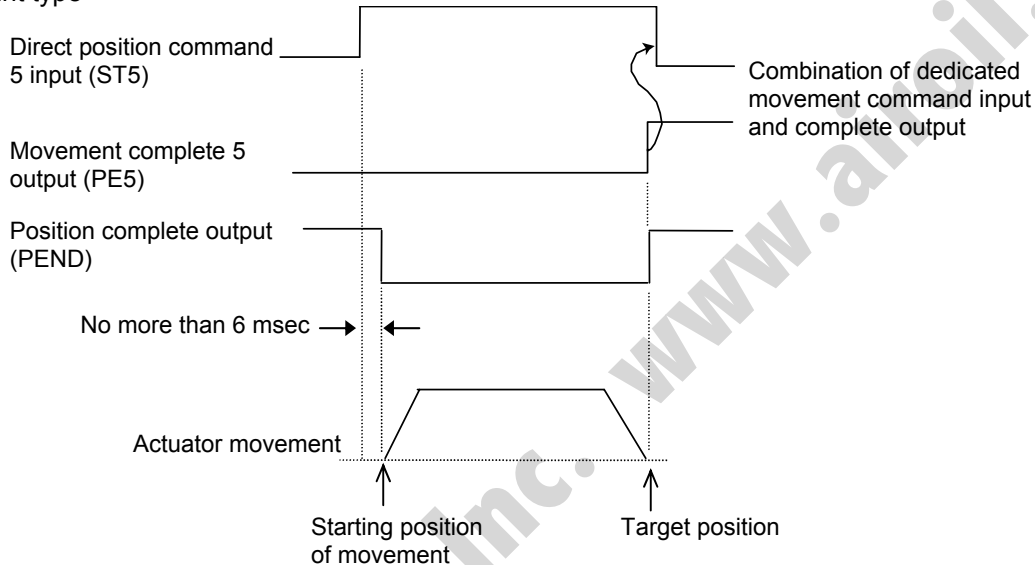

\* In the 64-point type, a position command input (binary) signal and a start input signal must be turned ON at staggered timings to initiate movement (refer to the next page). In this type, however, there is only one input signal that needs to be turned ON.

### ■ Explanation of I/O signals

Signal name	Category	Function explanation
Direct position command 0 (ST0)	Input	Movement command to the target position for position No. 0
Direct position command 1 (ST1)		Movement command to the target position for position No. 1
Direct position command 2 (ST2)		Movement command to the target position for position No. 2
Direct position command 3 (ST3)		Movement command to the target position for position No. 3
Direct position command 4 (ST4)		Movement command to the target position for position No. 4
Direct position command 5 (ST5)		Movement command to the target position for position No. 5
Direct position command 6 (ST6)		Movement command to the target position for position No. 6
Movement complete 0 (PE0)	Output	Indicates that the actuator reached the target position for position No. 0.
Movement complete 1 (PE1)		Indicates that the actuator reached the target position for position No. 1.
Movement complete 2 (PE2)		Indicates that the actuator reached the target position for position No. 2.
Movement complete 3 (PE3)		Indicates that the actuator reached the target position for position No. 3.
Movement complete 4 (PE4)		Indicates that the actuator reached the target position for position No. 4.
Movement complete 5 (PE5)		Indicates that the actuator reached the target position for position No. 5.
Movement complete 6 (PE6)		Indicates that the actuator reached the target position for position No. 6.

# PCON

[2] 64-point type

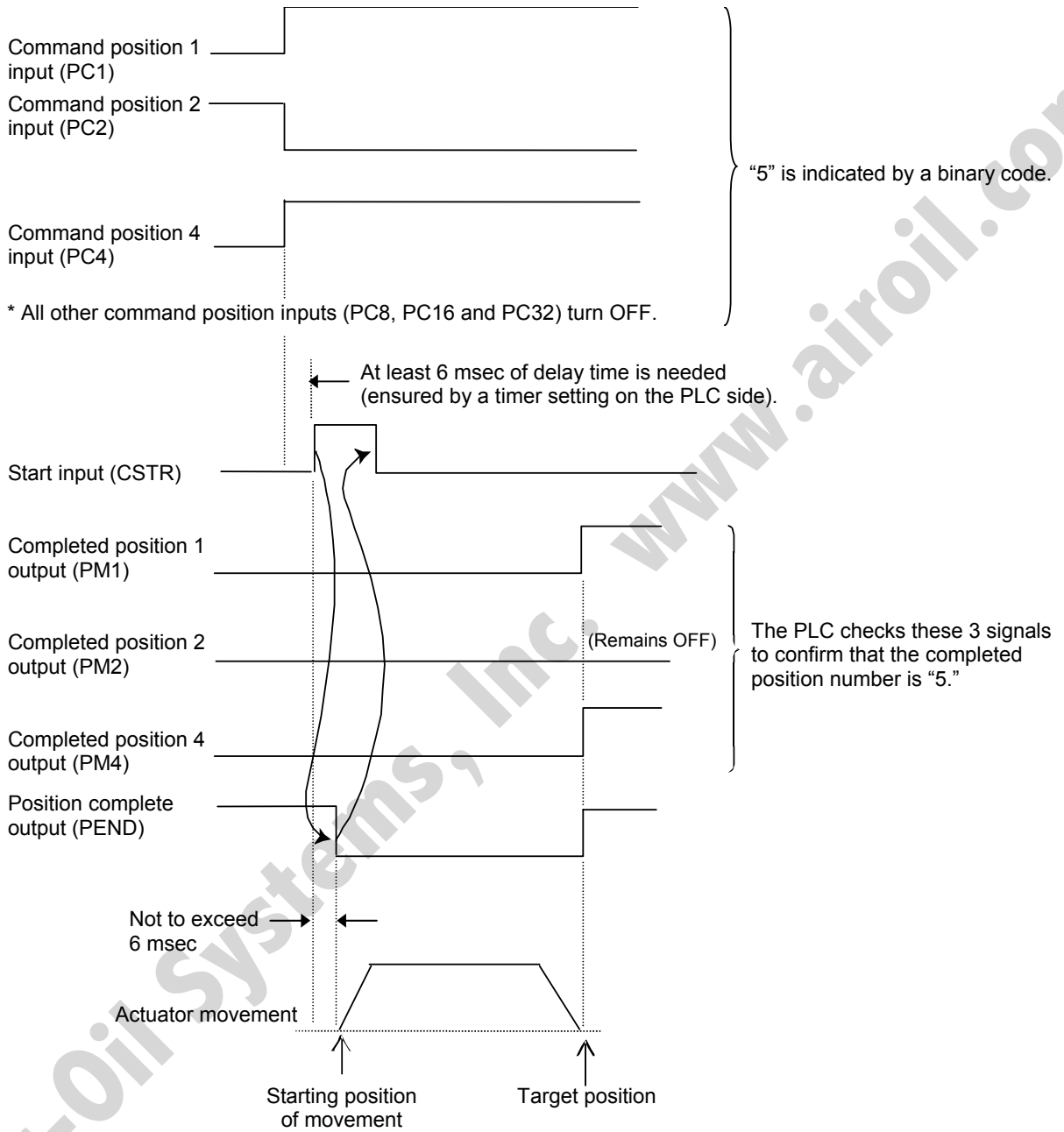

## 6.2.11 Overview of 3-point Type

This type provides a control method adjusted to that of an air cylinder by assuming that the controller is used as an air cylinder.

The key differences between this controller and an air cylinder are summarized in the table below.

Program appropriate controls by referring to this table.

\* Do not use this mode for push & hold operation.

Item	Air cylinder	PCON								
Drive method	Air pressure supplied via electromagnetic valve control	Ball-screw or timing-belt drive using a pulse motor								
Target position setting	Mechanical stopper (including shock absorber)	<p>Desired coordinates are entered in the [Position] field of the position table. Coordinates can be entered from the PC/teaching pendant using the keyboard/keys, or the actuator can be moved to the desired position to read the achieved coordinates directly. Example) 400-mm stroke</p> <table border="1"> <thead> <tr> <th>Position No.</th> <th>Position</th> </tr> </thead> <tbody> <tr> <td>0</td> <td>5 (mm) Rear end</td> </tr> <tr> <td>1</td> <td>400 (mm) Front end</td> </tr> <tr> <td>2</td> <td>200 (mm) Intermediate point</td> </tr> </tbody> </table>	Position No.	Position	0	5 (mm) Rear end	1	400 (mm) Front end	2	200 (mm) Intermediate point
Position No.	Position									
0	5 (mm) Rear end									
1	400 (mm) Front end									
2	200 (mm) Intermediate point									
Target position detection	An external detection sensor, such as a reed switch, is installed.	Determined based on the internal coordinates provided by the position information from the position detector (encoder). Accordingly, external detection sensor is not required.								
Speed setting	Adjusted by a speed controller.	A desired feed speed is entered in the [Speed] field of the position table (unit: mm/sec). Note that the rated speed is automatically set as the initial value.								
Acceleration/ deceleration setting	Determined in accordance with the load, supplied air volume, as well as the performance of the speed controller and electromagnetic valve.	<p>Desired acceleration/deceleration are entered in the [Acceleration] and [Deceleration] fields of the position table (minimum setting unit: 0.01 G). Reference: 1 G = Gravitational acceleration Note that the rated acceleration/deceleration is automatically set as the initial value. Since the acceleration/deceleration can be set in fine steps, a gradual acceleration/deceleration curve can be programmed.</p> <div style="text-align: center;"> <table border="1" style="display: inline-table; margin-right: 100px;"> <tr><td>Acceleration</td></tr> </table> <table border="1" style="display: inline-table;"> <tr><td>Deceleration</td></tr> </table> </div> <p>Setting a larger value makes the curve steeper, while setting a smaller value makes the curb more gradual.</p>	Acceleration	Deceleration						
Acceleration										
Deceleration										

Item	Air cylinder	RCP2
Position check upon power ON	Determined by an external detection sensor, such as a reed switch.	<p>Immediately after the power is turned on, the controller cannot identify the current position because the mechanical coordinates have been lost. Accordingly, a rear end command must always be executed after the power is turned on, to establish the coordinates. The actuator will perform home-return operation first, and then move to the rear end.</p> <p>[1] The actuator moves at the home return speed toward the mechanical end on the motor side.            [2] The actuator contacts the mechanical end and turns back, and then stops temporarily at the home position.            [3] The actuator moves to the rear end at the speed set in the [Speed] field of the position table.            (Note) Pay attention not to allow any obstacle in the travel path of the actuator during home return.</p>

The relationship of each movement command input/position detected and corresponding position number is shown below.

The input/output signals are given easy-to-identify names by following the naming convention of air-cylinder switches.

However, the target position is determined by the value set in the [Position] field for each position number. Therefore, changing the magnitude relationships of settings under position Nos. 0, 1 and 2 will change the meanings of input/output signals.

For this reason, it is recommended that you always use the signals under their names defined in this manual, unless doing so presents problem, so that the signals have the same meanings at all time.

Input signal	Output signal	Target position
Rear end move (ST0)	Rear end detected (LS0)	Value set in the [Position] field for position No. 0 Example) 5 mm
Front end move (ST1)	Front end detected (LS1)	Value set in the [Position] field for position No. 1 Example) 390 mm
Intermediate point move (ST2)	Intermediate point detected (LS2)	Value set in the [Position] field for position No. 2 Example) 200 mm

● Positioning relationship on the ROBO Cylinder

An example of a slider type with a stroke of 400 mm is explained.

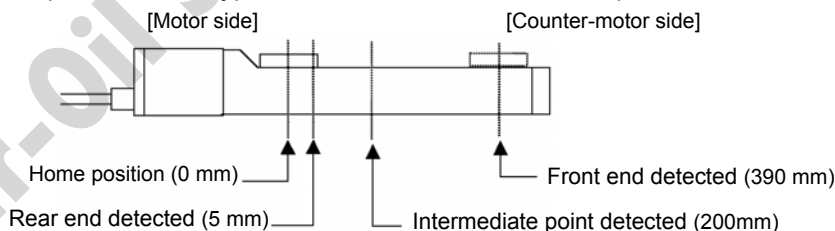

● Position table (Enter in the fields indicated in bold)

No.	Position [mm]	Speed [mm/s]	Acceleration [G]	Deceleration [G]	Push [%]	Positioning band [mm]
0	<b>5.00</b>	500.00	0.30	0.30	0	0.10
1	<b>390.00</b>	500.00	0.30	0.30	0	0.10
2	<b>200.00</b>	500.00	0.30	0.30	0	0.10

## 6.3 Notes on the ROBO Gripper

### (1) Finger operation

#### [1] Definition of position

The specified stroke of the 2-finger type indicates the sum of travel distances of both fingers. In other words, the travel distance of one finger is one half the specified stroke.

A position you specify defines the distance traveled by one finger from the home position in the closing direction.

Accordingly, the maximum command value is 5 mm for the GRS type and 7 mm for the GRM type.

#### [2] Definition of speed and acceleration

The command value applies to each finger.

The relative speed and acceleration of the 2-finger type are twice the command values.

#### [3] Operation mode in gripper applications

When the actuator is used to grip the load, be sure to select the "push & hold mode."

(Note) In the "positioning mode," a servo error may occur while the load is gripped.

[Diagrams of gripping force and current-limiting value]

[GRS]

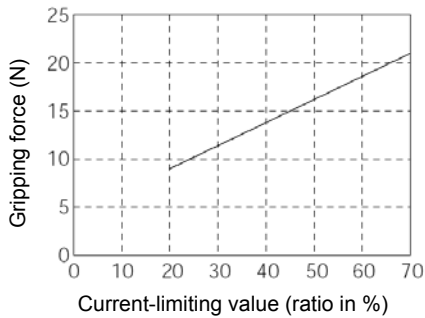

[GRM]

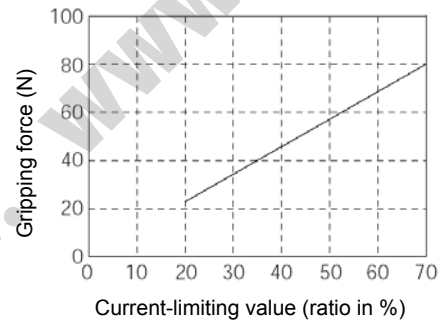

[GR3SS]

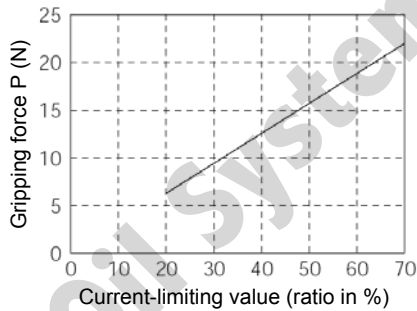

[GR3SM]

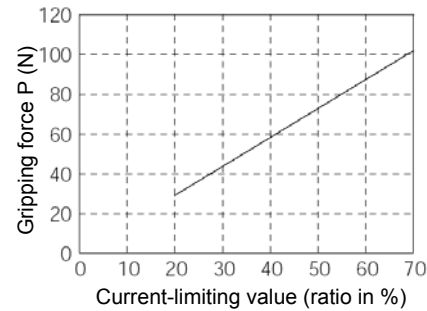

[GR3LS]

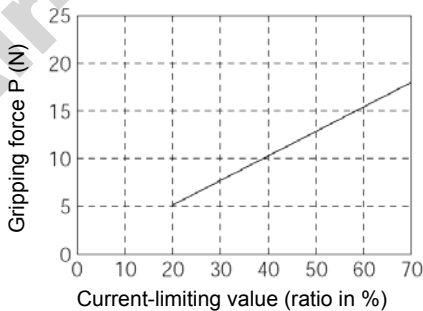

[GR3LM]

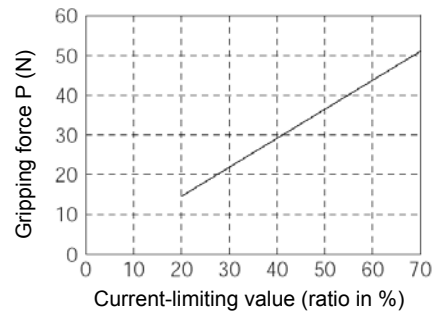

## (2) Removing the gripped load

This gripper is designed to maintain the load-gripping force via a self-lock mechanism even when the servo is turned OFF or the controller power is cut off.

If the gripped load must be removed while the power is cut off, do so by turning the open/close screw or removing the finger attachment on one side.

### [2-finger type]

Turn the open/close screw or remove the finger attachment on one side.

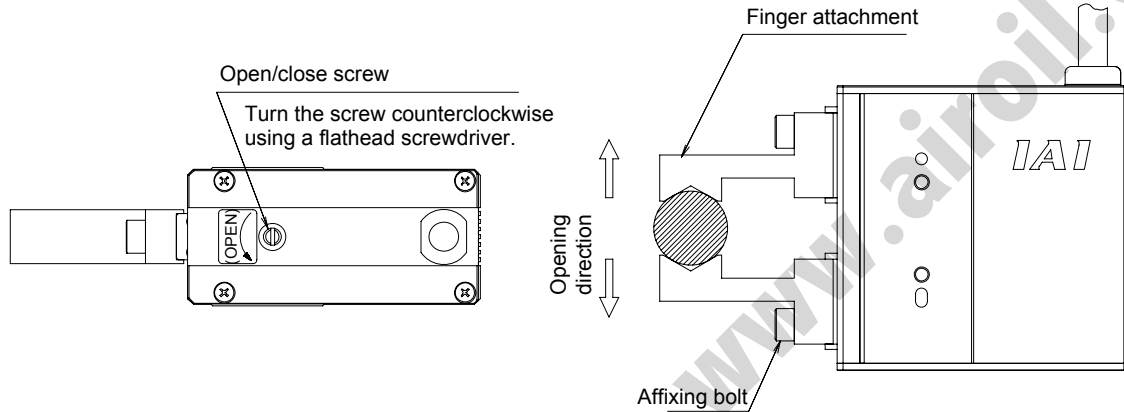

### [3-finger type]

Remove one finger attachment.

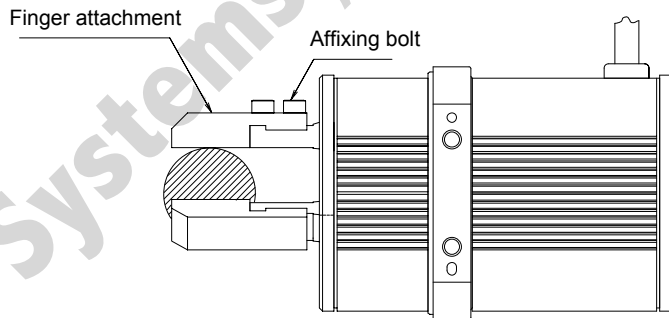

## 6.4 Power-saving Modes at Standby Positions

One general feature of pulse motors is that their holding current in standstill state is greater than AC servo motors.

Therefore, this product provides energy-saving modes to reduce power consumption in situations where the actuator remains standstill for a long period at a standby position.

Use these modes after confirming that they will not present problems to any part of your system.

Each mode produces a different level of power-saving effect. Follow the instructions provided below and select an optimal mode appropriate for the specific standstill condition of your actuator.

- PIO pattern = 5: Solenoid valve mode 2 [3-point type]

The actuator stands by with the servo on after the power has been turned on

In this condition, you can select full servo control using parameter No. 53 (Default standstill mode). Automatic servo-off control cannot be selected. If you have set 1, 2 or 3 by mistake, the setting will be ignored.

(This setting is not affected by the value in the “Standstill mode” field of the position table.)

The actuator stands by after completing the positioning to the target position set in the “Position” field for the applicable position number

In this condition, you can select one of two modes based on the value in the “Standstill mode” field of the position table.

(This setting is not affected by the value of parameter No. 53.)

- [1] Full servo control
- [2] Automatic servo-off control

- PIO pattern = Other than 5: Solenoid valve mode 2 [3-point type]

The actuator stands by after completing the home return operation effected by the HOME input signal

In this condition, you can select one of two modes based on the value of parameter No. 53 (Default standstill mode).

(This setting is not affected by the value in the “Standstill mode” field of the position table.)

- [1] Full servo control
- [2] Automatic servo-off control

The actuator stands by after completing the positioning to the target position set in the “Position” field for the applicable position number

In this condition, you can select one of two modes based on the value in the “Standstill mode” field of the position table.

(This setting is not affected by the value of parameter No. 53.)

- [1] Full servo control
- [2] Automatic servo-off control

### 2. Meanings of values set in the “Standstill mode” field of the position table and in parameter No. 53

	Setting
All power-saving modes are disabled. (The actuator is completely stopped.)	0
Automatic servo-off mode. The delay time is defined by parameter No. 36.	1
Automatic servo-off mode. The delay time is defined by parameter No. 37.	2
Automatic servo-off mode. The delay time is defined by parameter No. 38.	3
Full servo control mode	4



■ Full servo control mode

The pulse motor is servo-controlled to reduce the holding current.

Although the exact degree of current reduction varies depending on the actuator model, load condition, etc., the holding current decreases to approx. 1/2 to 1/4.

Since the servo remains on, position deviation will not occur.

The actual holding current can be checked in the current monitor screen of the PC software.

Take note that micro-vibration or noise may occur in certain conditions where external force is applied, or depending on the position where the actuator has stopped.

If micro-vibration or noise presents problem, do not use this mode.

■ Automatic servo-off mode

After positioning is completed, the servo will turn off automatically upon elapse of a specified time.

(Since no holding current flows, power consumption will decrease.)

When the next movement command is received from the PLC, the servo will turn on and the actuator will start moving.

\* Since the servo turns off once, some position deviation may occur. Do not use this function at standby positions where position deviation will cause problem.

You should also note that the position complete (PEND), completed position number (PM1 to PM256) and movement complete (PE0 to PE6) signals will turn OFF because the servo turns off. However, you can keep the signals ON via a parameter in situations where the PLC sequence circuit is designed in such a way that problems will occur if complete signals turn OFF.

Setting of parameter No. 39 (Output mode of position complete signal)	[1] PIO pattern = 0 to 3 Position complete (PEND) signal status, completed position number (PM1 to PM256) signal status [2] PIO pattern = 4 Position complete (PEND) signal status, movement complete (PE0 to PE6) signal status
0 [PEND]	The signal will turn OFF unconditionally when the servo turns off. Even when the next movement command is issued and the servo turns on again, the actuator has already started moving to the next target position, so the signal still remains OFF.
1 [INP]	Even when the servo is off, the signal turns ON if the current position is within the range set by the "Positioning band" field of the position table, with respect to the target position, and turns OFF if the current position is outside this range.

(Note) The factory setting is "0."

# P CON

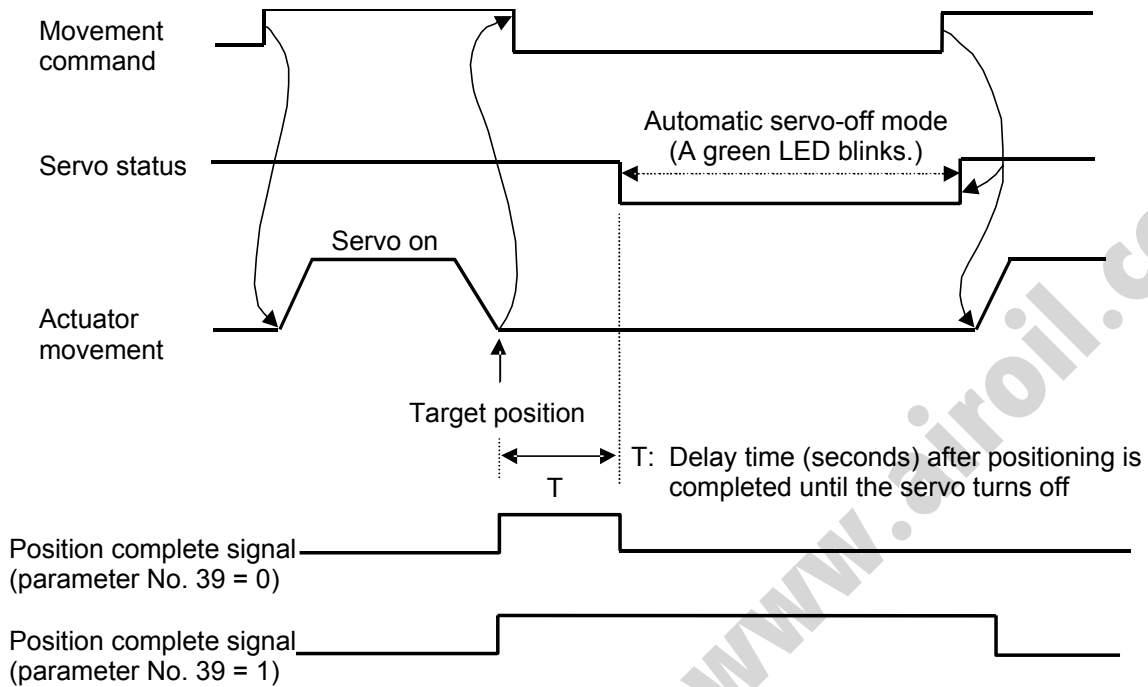

**Warning:** If the next movement command is specified in the incremental mode (based on constant pitch feed), never use the automatic servo-off mode. The current position may deviate slightly as the servo turns off and then on again.

**Caution:** In push & hold operation, both the full servo control mode and automatic servo-off mode become ineffective once the operation has completed successfully. If the actuator has missed the load, the specified mode becomes effective. Basically, you should not use either the full servo control mode or automatic servo-off mode in push & hold operation.

## 7. Operation <Practical Steps>

### 7.1 How to Start

#### 7.1.1 Timings after Power On

##### ■ Procedure after initial startup until actuator adjustment

- [1] Connect the motor relay cable to the MOT connector and encoder relay connector to the PG connector.
- [2] Connect the supplied flat cable to the PIO connector (for connection between the host PLC and I/O unit).
- [3] Reset the emergency stop or enable the supply of motor drive power.
- [4] Supply the 24-VDC I/O power (1A/2A pins (+24 V) and 19B/20B pins (0 V) in the PIO connector).
- [5] Supply the 24-VDC controller power (24-V and 0-V terminals on the power-supply terminal block).
  - \* If the monitor LED [SV/ALM] on the front panel illuminates for 2 seconds initially and then turns off, the controller is normal. If [SV/ALM] illuminates in red, an alarm is present. In this case, connect a PC or teaching pendant to check the nature of the alarm and remove the cause by referring to Chapter 10, "Troubleshooting."
- [6] Set the minimum set of required parameters initially.  
Set the mode selector switch on the front panel to the "MANU" side.  
On the PC or teaching pendant, set the MANU operation mode to "Teaching mode: Enable safety speed].  
Change the necessary parameters in this condition.  
(Example) • Use a PIO pattern other than "Standard type" → Parameter No. 25 (PIO pattern selection)
  - Reduce the safety jog speed → Parameter No. 35 (Safety speed)
- [7] Check the actuator position.  
Confirm that the slider or rod is not contacting a mechanical end.  
If the slider/rod is contacting a mechanical end, move it away from the mechanical end. If the slider/rod is not contacting a mechanical end but is closer to the home position, move the slider/rod away from the home position.  
If the actuator is equipped with a brake, turn on the brake forced-release switch to forcibly release the brake before moving the actuator.  
The slider/rod may suddenly drop due to its dead weight when the brake is released, so exercise caution not to damage the robot hand or load by the falling slider/rod.  
If the actuator cannot be moved by hand because the screw lead is short, change the setting of parameter No. 28 (Default direction of excited-phase signal detection) to the direction opposite to the mechanical end.

#### Warning

If the servo is turned ON while the slider/rod is contacting the mechanical end, excitation phase detection may not be performed correctly and an abnormal operation or excitation detection error may result.

- [8] Turn on the servo.  
Turn on the servo using the "servo ON function" of the PC software or teaching pendant.  
If the actuator enters a servo lock mode and the monitor LED [SV/ALM] on the front panel illuminates in green, the controller is functioning properly.
- [9] Check the operation of the safety circuit.  
Confirm that the emergency stop circuit (or motor drive-power cutoff circuit) operates properly.

[10] Perform home return.

- Overview of operation on the teaching pendant
  - On the RCM-T, select the “Edit/Teach” screen, bring the cursor to “\*Home” in the sub display area, and then press the Return key.
  - On the RCM-E, select the “Teach/Play” screen, scroll until “\*Home Return” is displayed, and then press the Return key.

[11] Set a target position in the “Position” field of the position table.

Set a target position in the “Position” field of each position table.

Determine a desired target position by fine-adjusting the load and hand via jogging or inching.

Also adjust the servo gain, if necessary.

- \* Once a target position has been set, other fields (speed, acceleration/deceleration, positioning band, etc.) will be automatically populated by their default values. Set optimal values for the speed, acceleration/deceleration, positioning band, etc.

- \* For safety reasons, it is recommended that the safety speed be enabled during the initial movement.

To move the actuator at the actual speed set in the “Speed” field of the position table, change the MANU operation mode to [Teaching mode: Disable safety speed].

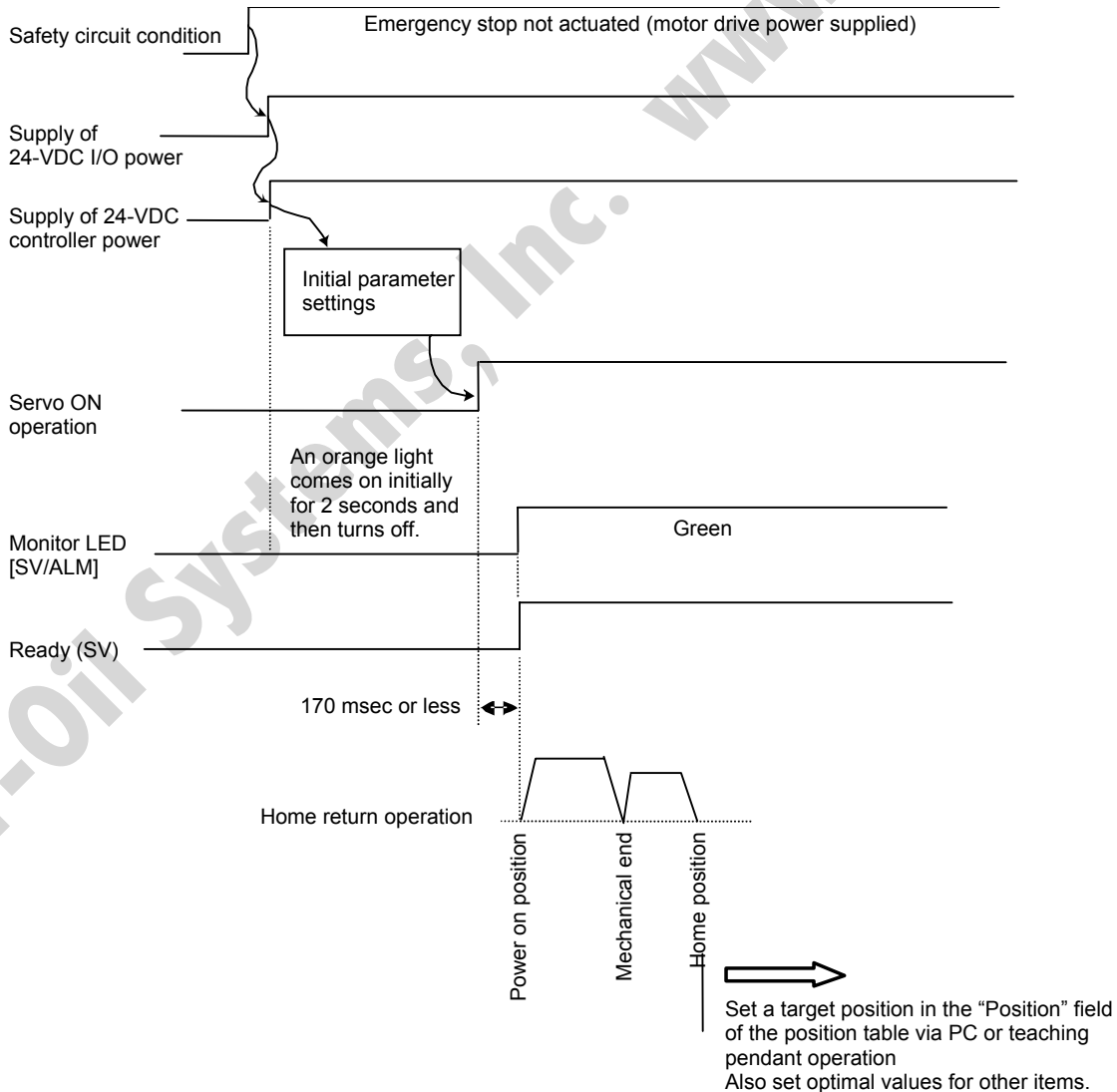

## ■ Procedure of Normal Operation

The operating procedure in normal condition is specified below:

- [1] Reset the emergency stop or enable the supply of motor drive power.
- [2] Supply the 24-VDC I/O power.
- [3] Supply the 24-VDC controller power.
  - \* If the monitor LED [SV/ALM] on the front panel illuminates for 2 seconds initially and then turns off, the controller is normal. If [SV/ALM] illuminates in red, an alarm is present. In this case, connect a PC or teaching pendant to check the nature of the alarm and remove the cause by referring to Chapter 10, "Troubleshooting."
- [4] Check the actuator position.

Confirm that the slider or rod is not contacting a mechanical end.  
If the slider/rod is contacting a mechanical end, move it away from the mechanical end. If the slider/rod is not contacting a mechanical end but is closer to the home position, move the slider/rod away from the home position.  
If the actuator is equipped with a brake, turn on the brake forced-release switch to forcibly release the brake before moving the actuator.  
The slider/rod may suddenly drop due to its dead weight when the brake is released, so exercise caution not to damage the robot hand or load by the falling slider/rod.  
If the actuator cannot be moved by hand because the screw lead is short, change the setting of parameter No. 28 (Default direction of excited-phase signal detection) to the direction opposite to the mechanical end.

### Warning

If the servo is turned ON while the slider/rod is contacting the mechanical end, excitation phase detection may not be performed correctly and an abnormal operation or excitation detection error may result.

- [5] Set the mode selector switch on the front panel of the controller to the "AUTO" side.
- [6] Input the servo ON signal/pause signal from the PLC.
- [7] Input the home return signal from the PLC to perform home return operation.
- [8] Start automatic operation.

 Caution: When operating the actuator using the PLC and I/O signals, be sure to set the mode selector switch on the front panel to the "AUTO" side.

# P CON

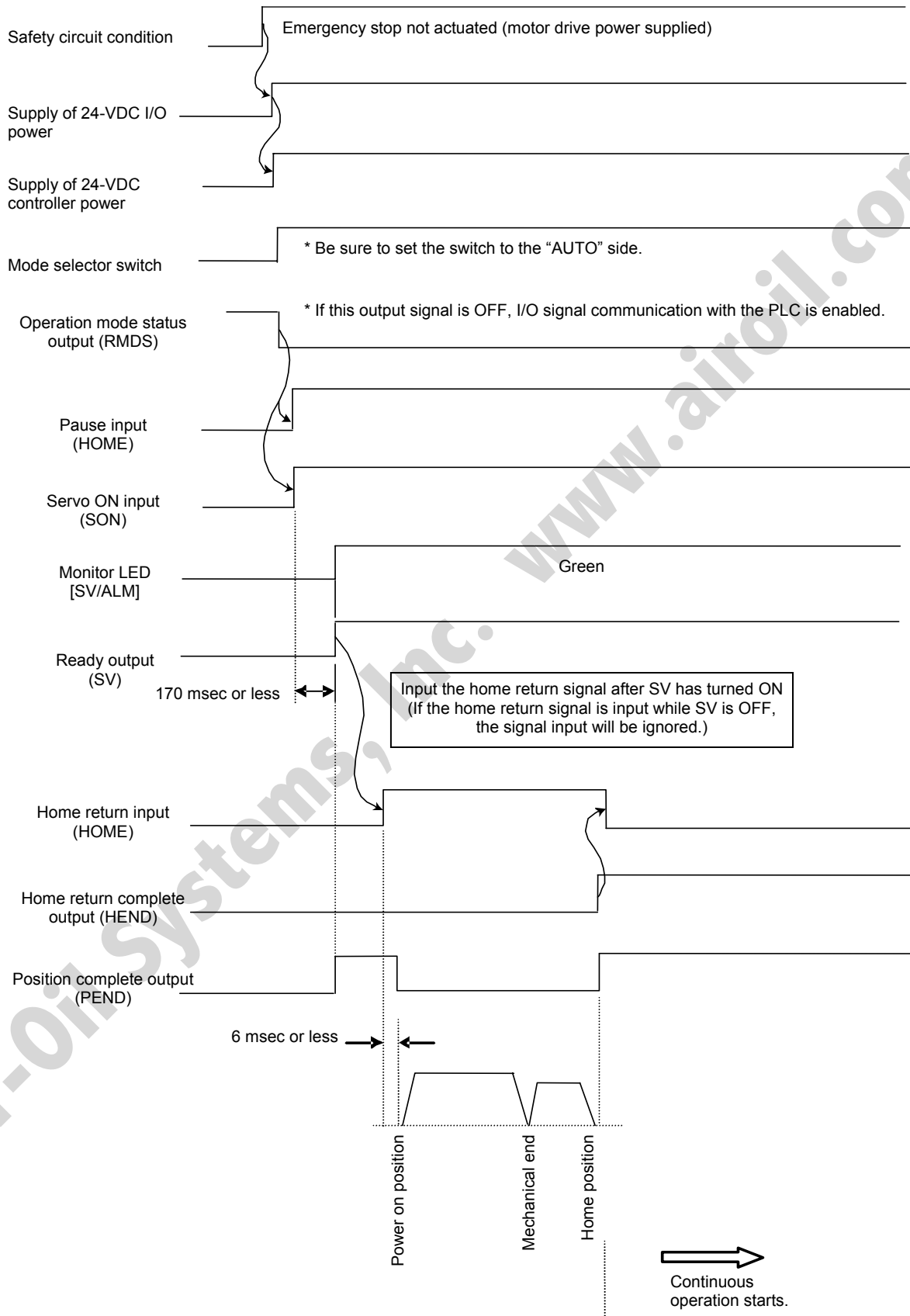

**⚠ Warning:** Since the drive motor uses a pulse motor, excited-phase detection is performed when the servo is first turned on after the power on.  
Therefore, the actuator must be able to move when the servo turns on.  
If the slider or rod is contacting a mechanical end or the load is contacting any surrounding equipment, excited-phase detection will not be performed correctly and an abnormal operation or excited-phase detection error may occur.  
In this case, move the actuator by hand to a position where it can move before the servo turns on.  
If the actuator is equipped with a brake, the brake must be forcibly released by turning on the brake release switch. The slider/rod may suddenly drop due to its dead weight when the brake is released, so exercise caution not to pinch your hand or damage the robot hand or load by the falling slider/rod.  
If the actuator cannot be moved by hand, one possible solution is to change the setting of parameter No. 28 (Default direction of excited-phase signal detection). If you wish to change this parameter, consult IAI beforehand.

Air-Oil Systems, Inc. www.airoil.com

## 7.1.2 Position Table and Parameter Settings Required for Operation

### ■ Startup adjustment

Immediately after the system has been started, the moving speed can be reduced by the methods specified below to ensure safety of operators and prevent damage to jigs, etc.

Change the applicable parameters, if necessary.

→ For details on the setting-change operations, refer to the operation manual for your PC software/teaching pendant.

#### Safety speed during manual feed

To move the actuator using the PC/teaching pendant, set the mode selector switch on the front panel of the controller to the "MANU" side.

For safety reasons, it is recommended that the actuator be moved at the safety speed during manual feed. To do this, change the MANU operation mode to [Teaching mode: Enable safety speed] on the PC/teaching pendant.

The safety speed is defined by parameter No. 35. Change the parameter value, if necessary.

Take note that the maximum speed is limited to 250 mm/s or below.

The factory setting is "100 mm/s" or below.

#### Speed override for movement commands from the PLC

You can lower the feed speed to be applied when the actuator is moved by the movement commands output from the PLC.

To lower the speed to below the level set in the "Speed" field of the position table, you can use parameter No. 46 to override the "Speed" field.

Actual moving speed = [Speed set in the position table] x [Value of parameter No. 46] ÷ 100

Example) Value in the "Speed" field of the position table 500 (mm/s)

Value of parameter No. 46 20 (%)

Under the above settings, the actual moving speed becomes 100 mm/s.

The minimum setting unit is "1%," while the input range is "1 to 100 %." The factory setting is "100 %."



## ■ Full-scale operation

This product provides energy-saving modes to reduce power consumption in situations where the actuator remains standstill for a long period at a standby position.

You can also select the status of position complete signal to be applied if the servo turns off or “position deviation” occurs while the actuator is standing still after completing positioning.

Use these functions after confirming that they will not present problems to any part of your system.

### Saving energy when the actuator stands by for a long time after the power has been turned on

Applicable to PIO pattern = 5 (3-point type)

In this condition, you can select full servo control using parameter No. 53 (Default standstill mode). (This setting is not affected by the value in the “Standstill mode” field of the position table.)

### Saving energy when the actuator stands by after completing the home return operation effected by the HOME input signal

Applicable to PIO pattern = 0 to 4

In this condition, you can select one of two modes based on the value in parameter No. 53 (Default standstill mode). (This setting is not affected by the value in the “Standstill mode” field of the position table.)

[1] Full servo control

[2] Automatic servo-off control

### Saving energy when the actuator stands by for a long time at the target position

Common to all PIO patterns

In this condition, you can select one of two modes based on the value in the “Standstill mode” field of the position table. (This setting is not affected by the value in Parameter No. 53.)

[1] Full servo control

[2] Automatic servo-off control

→ For details, refer to 6.4, “Power-saving Modes at Standby Positions” and 8.2.2, “Parameters Relating to the Actuator Operating Characteristics.”

### Output mode of complete signal

Applicable to PIO pattern = 0 to 4

You can select the status of position complete signal to be applied if the servo turns off or “position deviation” occurs while the actuator is standing still after completing positioning.

This setting uses parameter No. 39. Consider the characteristics of the control you need and select an appropriate mode.

→ For details, refer to 8.2.3, “Parameters Relating to the External Interface.”

## 7.2 Home Return Operation

### 7.2.1 Method Using the HOME Input Signal (PIO Pattern = 0 to 4)

Since the home return signal (HOME) is provided in PIO patterns 0 to 4, perform home return using this signal.

- When the home return signal (HOME) turns ON, the actuator starts moving toward the mechanical end on the home side.  
Once the mechanical end is contacted, the actuator reverses its direction and moves, and then stops at the home position.
- At the start of movement, the position complete output (PEND) turns OFF while the moving output (MOVE) turns ON.
- When the actuator stops at the home position, the position complete output (PEND) and home return complete output (HEND) turn ON. On the other hand, the moving output (MOVE) turns OFF.
- On the PLC side, turn OFF the home return signal (HOME) after the home return complete output (HEND) has turned ON.

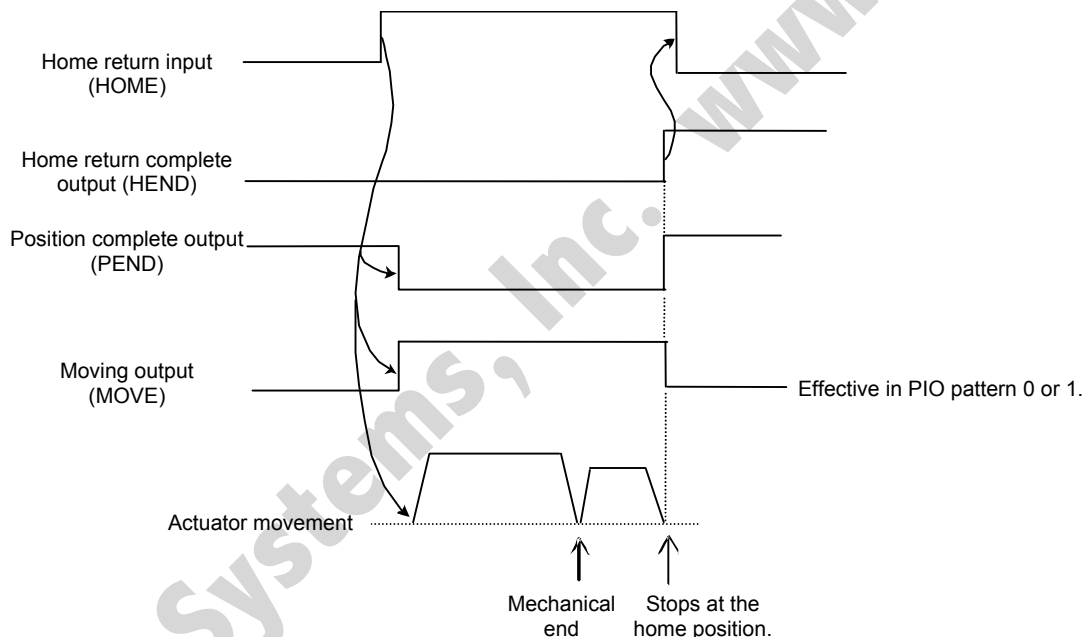

**⚠ Caution:** When performing home return, pay attention to the following:

- [1] Confirm that no obstacle is present in the home return direction.
- [2] If any obstacle is present in the home return direction, review the PLC sequence circuit and change the circuit so that home return will be executed only when there is no obstacle.

# P CON

(Note) If the home is not yet established immediately after the power has been turned on, directly inputting the command position signal and start signal without inputting the home return signal (HOME) first will cause the actuator to perform home return operation and then move to the target position. However, it is recommended that the PLC sequence circuit use the home return signal (HOME) to prevent errors.

[1] PIO pattern = 0 to 3

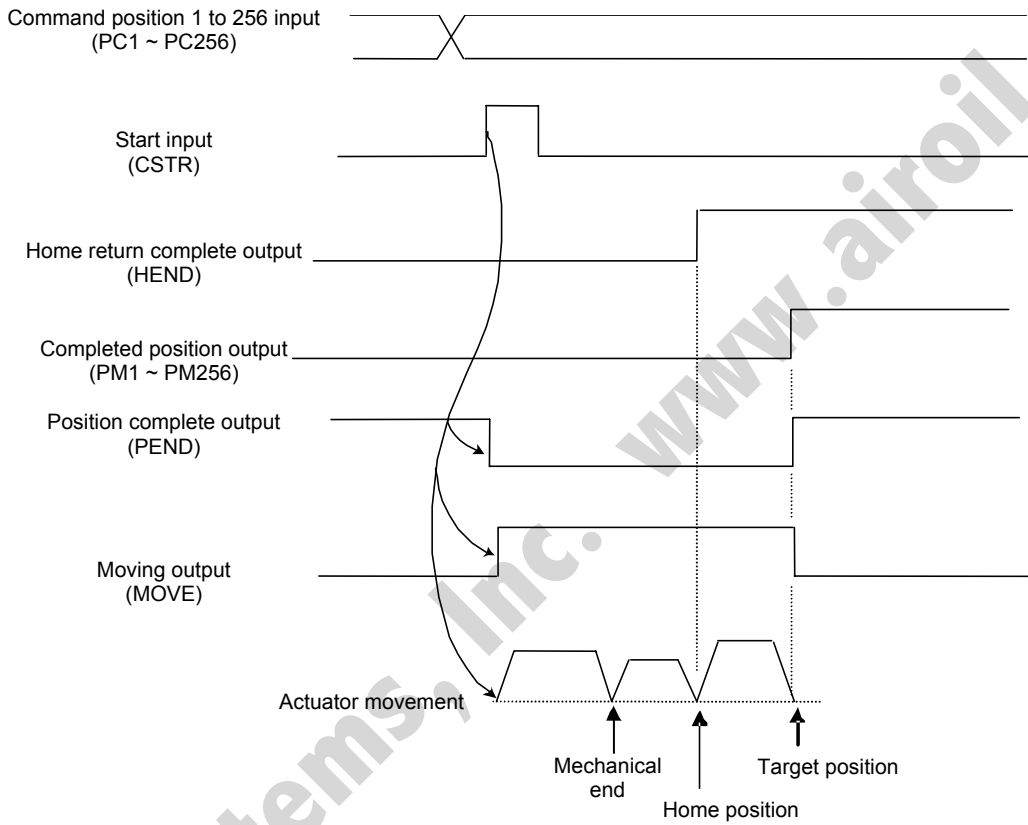

[2] PIO pattern = 4

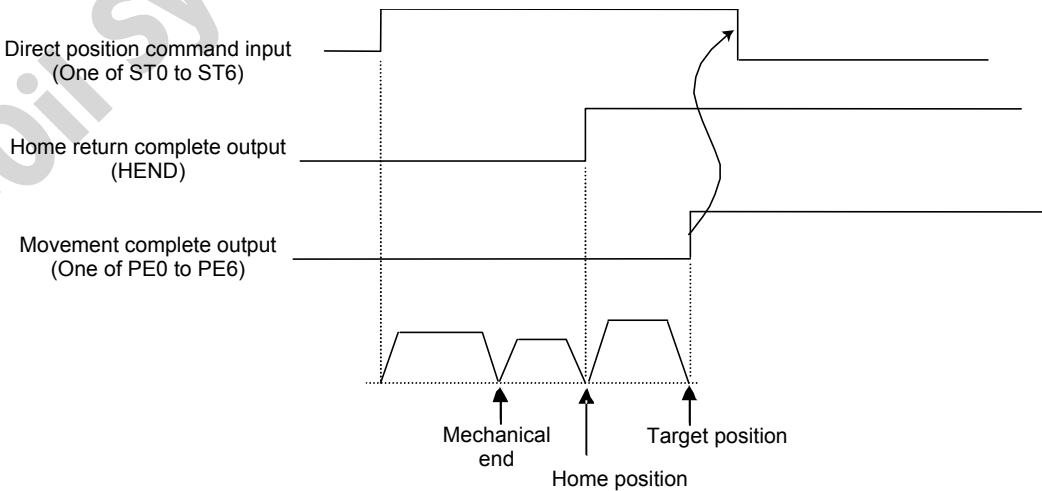

## 7.2.2 Method Used When No HOME Input Signal Is Available (PIO Pattern = 5)

Since no home return signal (HOME) is available in PIO pattern 5, input the rear end move command (ST0) first to perform home return.

- When the rear end movement command (ST0) turns ON, the actuator starts moving toward the mechanical end on the home side. Once the mechanical end is contacted, the actuator reverses its direction and moves to the home position, stops temporarily at the home position, and then moves to the rear end.
- Once the home position is reached, the home return complete output (HEND) turns ON.

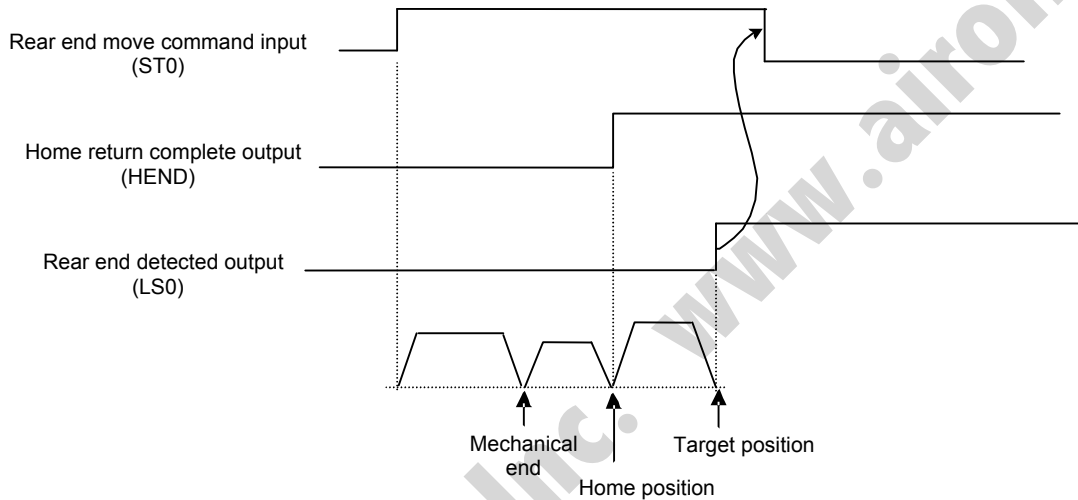

- ⚠ Caution: When performing home return, pay attention to the following:
- [1] Confirm that no obstacle is present in the rear end direction.
  - [2] If any obstacle is present in the rear end direction, move the actuator toward the front end and remove the obstacle. Issuance of the front end move command is permitted for this reason. In this case, the actuator moves forward at the home return speed and when the actuator reaches the mechanical end, the front end position complete output (LS1) turns ON.
  - [3] Do not input the intermediate point move command (even if the command is input, it will be ignored).

## 7.3 Positioning Mode (Back and Forth Movement between Two Points)

Example of use in operation) The actuator moves back and forth between two positions. The position 250 mm from the home is set as position 1, and the position 100 mm from the home is set as position 2. The travel speed to position 1 is set as 200 mm/sec, and to position 2 is set as 100 mm/sec.

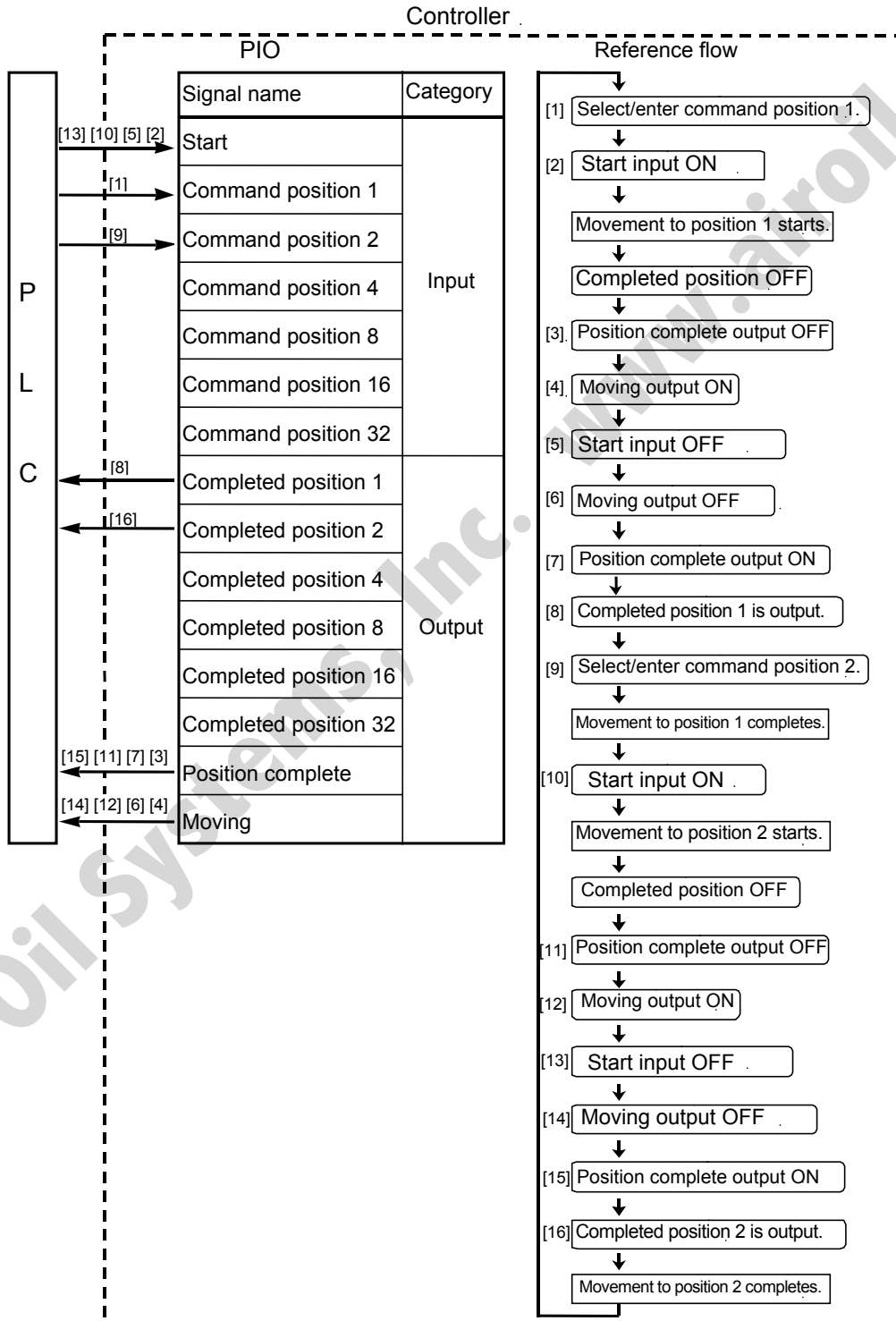

Position table (Field(s) within thick line must be entered.)

No.	Position [mm]	Speed [mm/s]	Acceleration [G]	Deceleration [G]	Push [%]	Positioning band [mm]
0	*	*	*	*	*	*
1	250.00	200.00	0.30	0.30	0	0.10
2	100.00	100.00	0.30	0.30	0	0.10
:						

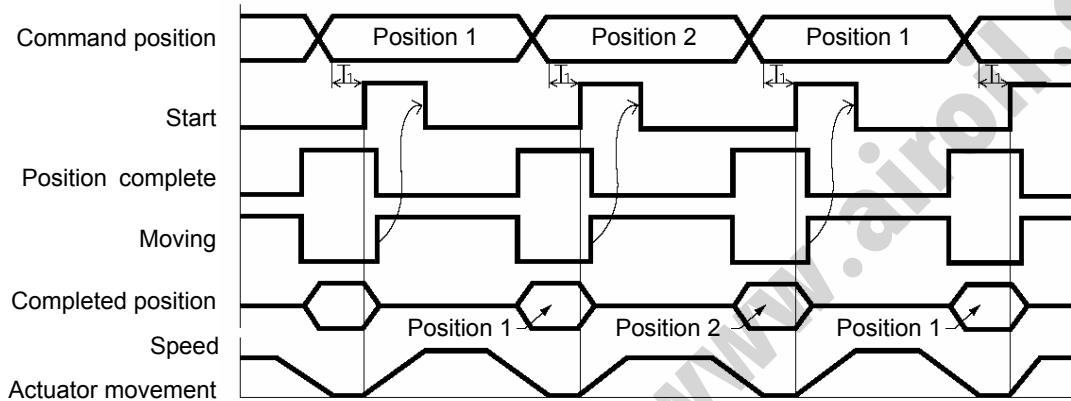

T1: 6 msec or more; time after selecting/entering a command position until the start input turns ON (The scan time of the host controller must be considered.)

Each command position must be input after the position complete output has turned ON for the movement to the previous position.

**Caution:**

- When the start signal turns ON, the position complete output will turn OFF and the moving output will turn ON.
- Always turn OFF the start signal after confirming that the start signal is currently ON and the position complete output has turned OFF.
- If the start input remains ON as shown below, the position complete output will not turn ON even when the actuator movement is completed.

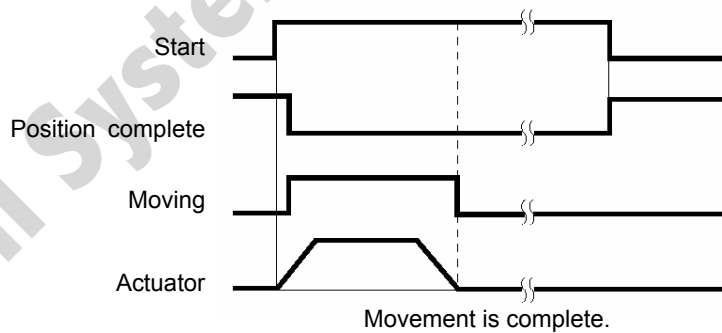

- If another movement command to the same position is issued, the position complete output will turn OFF, but the moving output will not turn ON.
- If the position complete signal turns ON, the moving output will also turn OFF simultaneously even when the actuator is moving.  
This means that, if the positioning band in the position data is increased, there may be cases where the actuator will continue to move after the moving output turns OFF simultaneously when the position complete output turns ON.
- When a software stroke limit is reached after continuous incremental moves, the actuator will stop immediately and a position complete signal will be output.

## 7.4 Push & Hold Mode

Example of use in operation) The actuator is caused to move back and forth in the push & hold mode and positioning mode. The position 280 mm from the home is set as position 1, and the position 40 mm from the home is set as position 2. Movement to position 1 is performed in the push & hold mode (the actuator is caused to contact the load and push it in the counter-motor direction). The maximum push amount at position 1 is set as 15 mm, and the current-limiting value during the push & hold operation by the stepper motor is set as 50%. Movement to position 2 is performed in the positioning mode. The travel speed to position 1 is set as 200 mm/sec, and that to position 2 is set as 100 mm/sec.

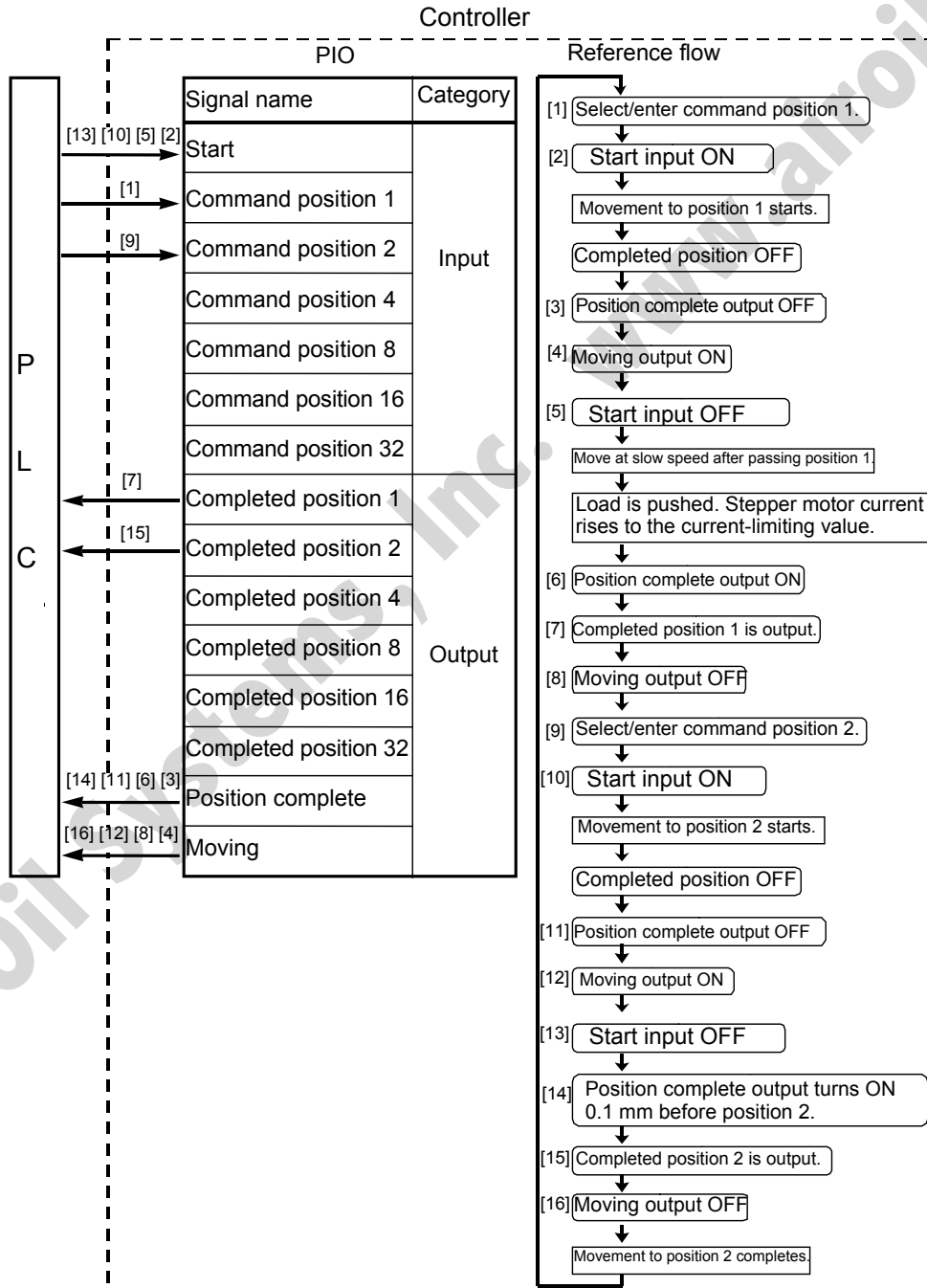

Position table (Field(s) within thick line must be entered.)

No.	Position [mm]	Speed [mm/s]	Acceleration [G]	Deceleration [G]	Push [%]	Positioning band [mm]
0	*	*	*	*	*	*
1	280.00	200.00	0.30	0.30	50	15.00
2	40.00	100.00	0.30	0.30	0	0.10
:						

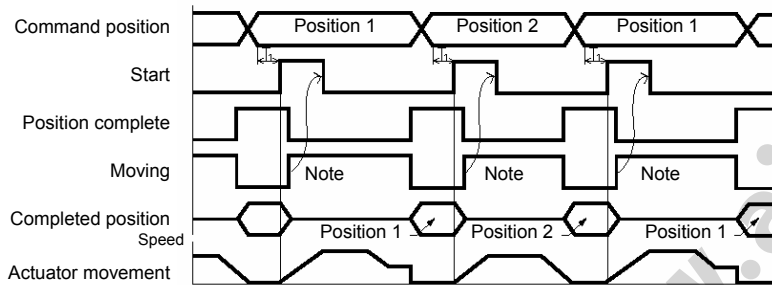

T1: 6 msec or more; time after selecting/entering a command position until the start input turns ON  
(The scan time of the host controller must be considered.)

Each command position must be input after the position complete output has turned ON for the movement to the previous position.

- Conditions for determining completion of push & hold operation

Push & hold operation is deemed to have completed upon elapse of the time set by parameter No. 6 (Push completion judgment time) after the motor current reached the current-limiting value set in the "Push" field of the position table.

Set an appropriate value by considering the material and shape of the load, and so on.

The minimum setting unit is "1 msec," while the maximum value is "9999 msec." The factory setting is "255 msec."

(Note) The chart below explains how completion of push & hold operation is determined if the load shifted during the judgment and the current has changed as a result, based on a judgment time of 255 msec.

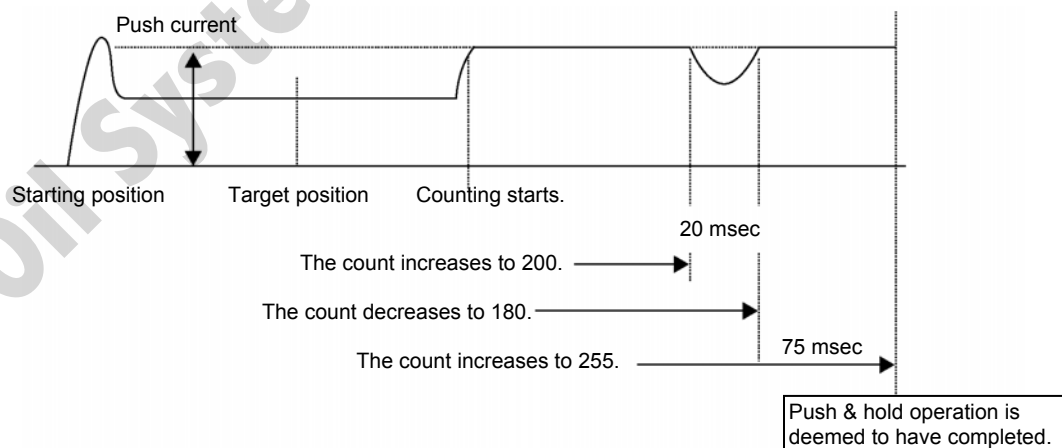

If the motor current remains at or above the push current for 200 msec and then drops below this level for 20 msec, the count will decrease by 20. When the push current is reached again thereafter, counting will start from 180. If the motor current remains at or above the push current for 75 msec, the count will increase to 255 and thus push & hold operation will be deemed to have completed. In total, 295 msec was required for the judgment.



## 7.4.1 Return Action after Push & Hold by Relative Coordinate Specification

- Positioning mode

The reference position is the target position for the position number used in the applicable push & hold operation.

In the aforementioned example, the actuator moves to the 240-mm position if position No. 2 is set to -40 mm in the incremental mode ( $280 - 40 = 240$  mm).

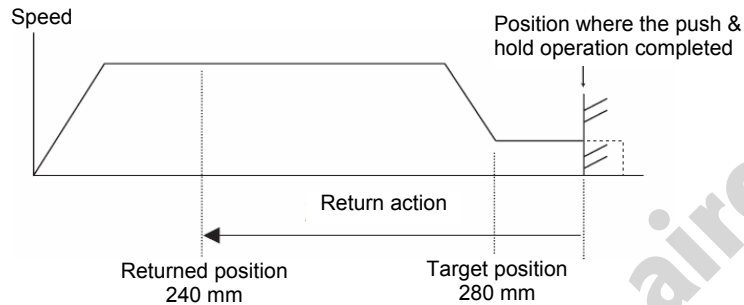

- Push & hold mode

The reference position is the position where the push & hold operation completed.

In the aforementioned example, the actuator moves to the 250.34-mm position if position No. 2 is set to -40 mm in the incremental mode and the push & hold operation completed at 290.34 mm ( $290.34 - 40 = 250.34$  mm).

(Note) In this case, the controller determines that the actuator has missed the load and thus does not turn ON the position complete signal.

It is therefore recommended that the zone output signal be used to determine completion of push & hold operation on the PLC side.

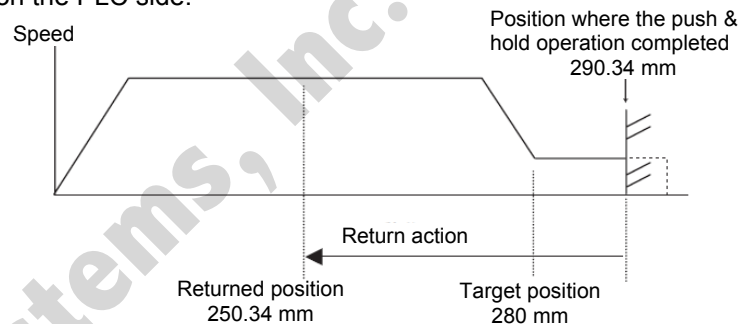

**Caution:** When the start signal turns ON, the position complete output will turn OFF and the moving output will turn ON.  
 Always turn OFF the start signal after confirming that the start signal is currently ON and the position complete output has turned OFF.  
 If the actuator has missed the load, the position complete output will not turn ON as shown below. The completed position will be output and the moving output will turn OFF.

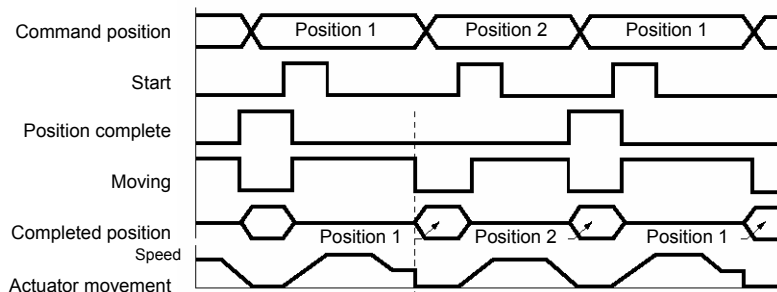

If the actuator has missed the load, the position complete output will not turn ON.

## 7.5 Speed Change during Movement

Example of use in operation) The actuator speed is reduced at a certain point during movement. The position 150 mm from the home is set as position 1, and the position 200 mm from the home is set as position 2. The actuator is initially located between the home and position 1. The actuator is moved to position 2 being the target position, at a travel speed of 200 mm/sec to position 1 and that of 100 mm/sec from position 1 to position 2.

Method) In this example, the actuator is caused to move to position 1 and to position 2 successively. Before the actuator is stopped at position 1, command position 2 must be selected/entered and the start signal must be input. To do this, set a wide positioning band at position 1 and cause the start signal for movement to position 2 to be input immediately after the completion signal for movement to position 1 is output. (Command position 2 should be entered while the actuator is moving to position 1.)

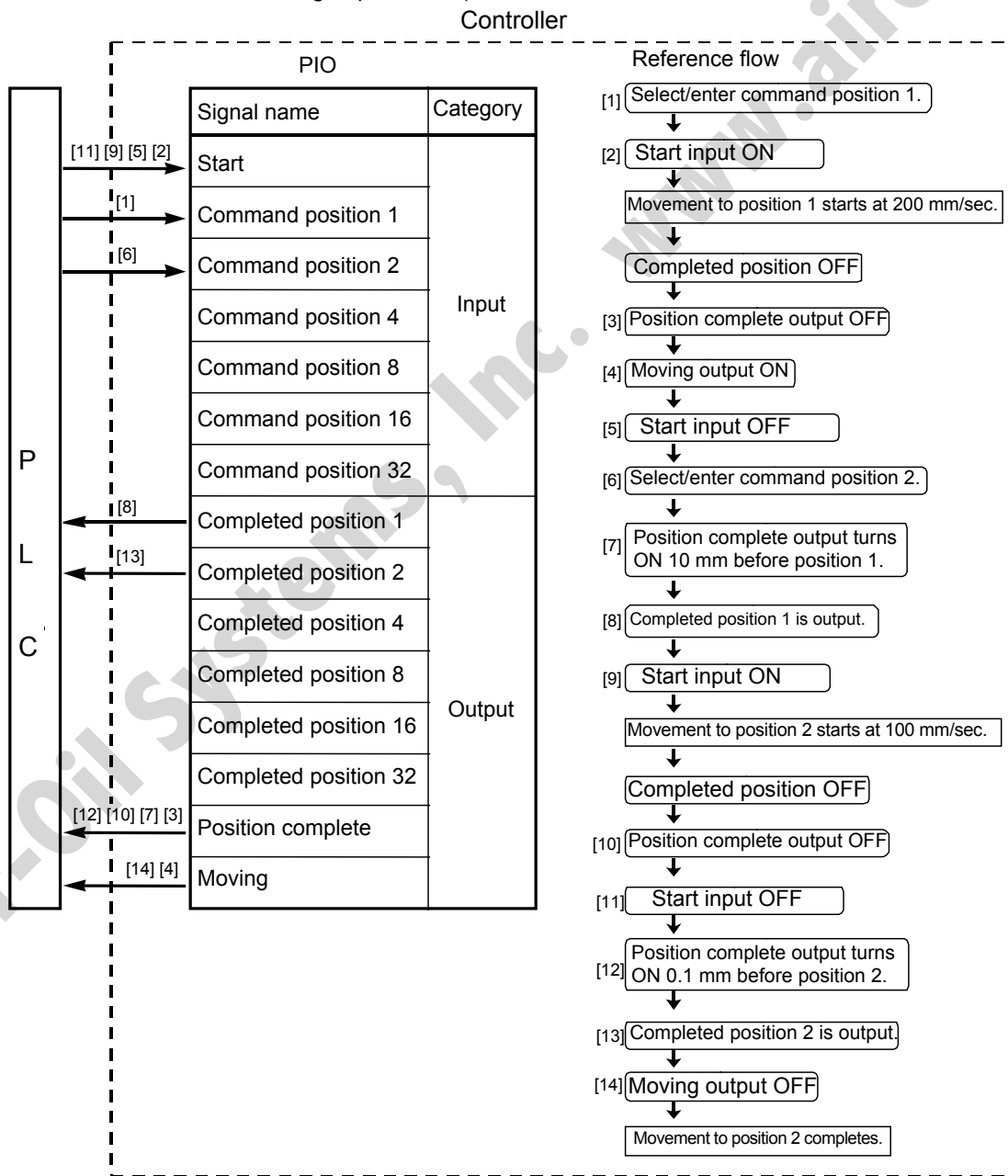

Position table (Field(s) within thick line must be entered.)

No.	Position [mm]	Speed [mm/s]	Acceleration [G]	Deceleration [G]	Push [%]	Positioning band [mm]
0	*	*	*	*	*	*
1	150.00	200.00	0.30	0.30	0	10.00
2	200.00	100.00	0.30	0.30	0	0.10
:						

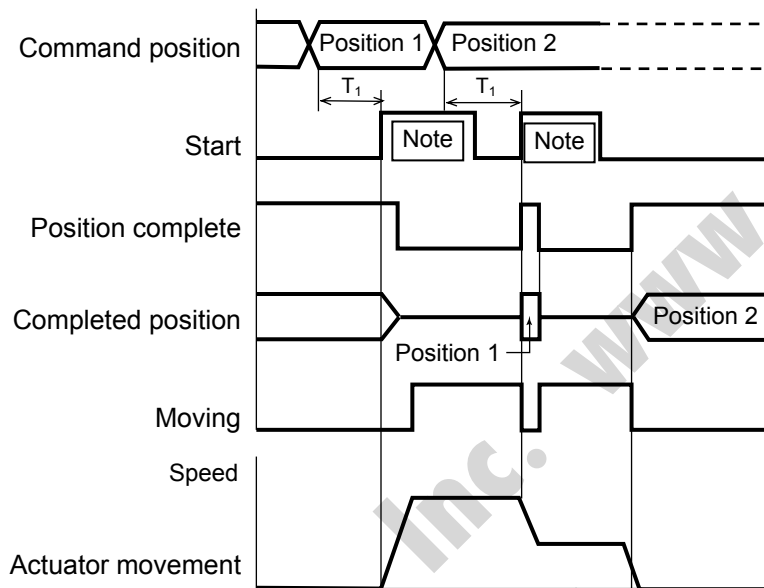

T1: 6 msec or more; time after selecting/entering a command position until the start input turns ON (The scan time of the host controller must be considered.)

**Caution:** When the start signal turns ON, the position complete output will turn OFF and the moving output will turn ON.  
Always turn OFF the start signal after confirming that the start signal is currently ON and the position complete output has turned OFF.

## 7.6 Operation at Different Acceleration and Deceleration Settings

Example of use in operation) Positioning is performed to the position 150 mm from the home (position 1) at a speed of 200 mm/sec.

The acceleration is 0.3 G and the deceleration is 0.1 G.

Method) Set 0.3 [G] in the "Acceleration" field and 0.1 [G] in the "Deceleration" field of the position table.

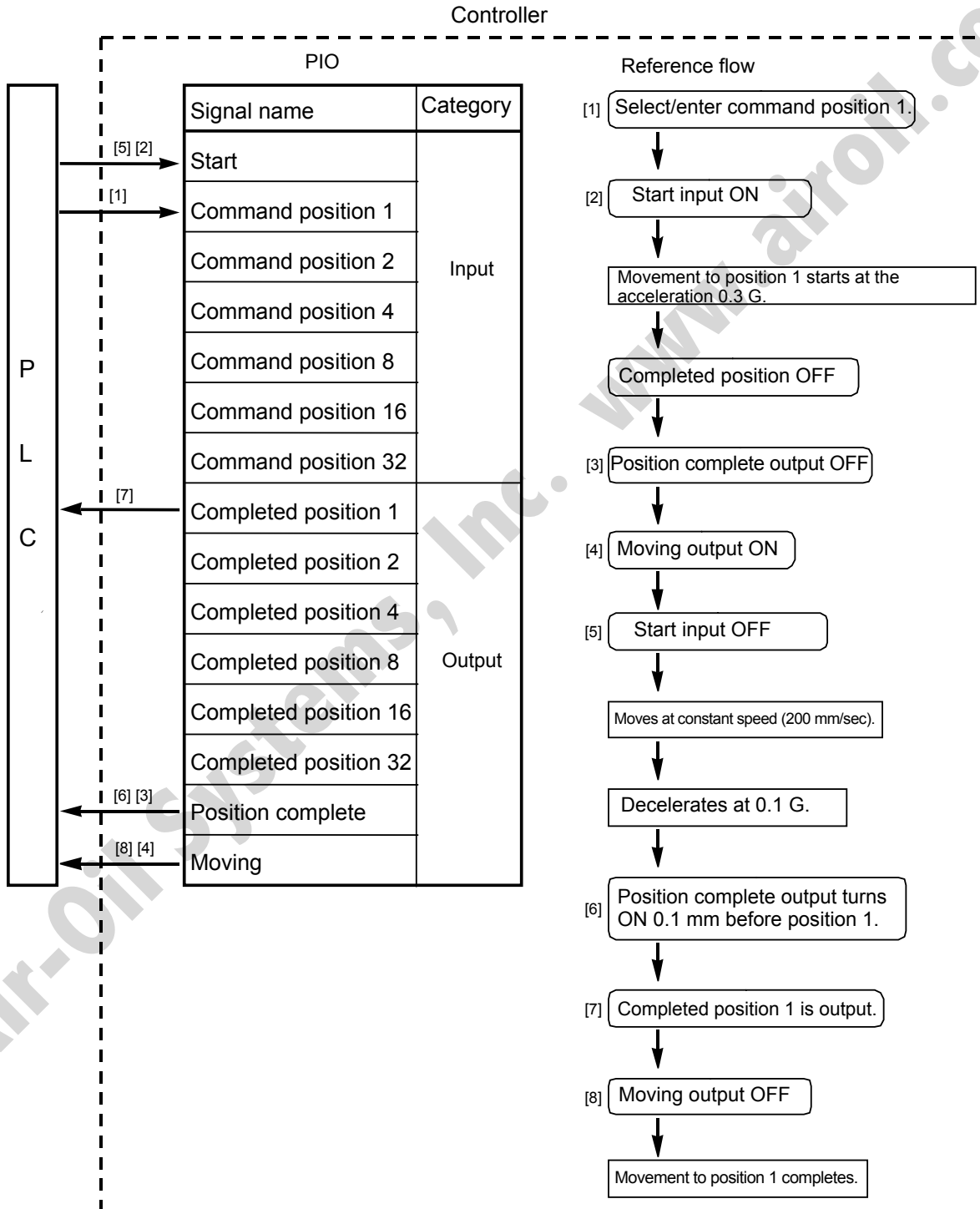

Position table (Field(s) within thick line must be entered.)

No.	Position [mm]	Speed [mm/s]	Acceleration [G]	Deceleration [G]	Push [%]	Positioning band [mm]
0	*	*	*	*	*	*
1	150.00	200.00	0.30	0.10	<b>0</b>	0.10
:						

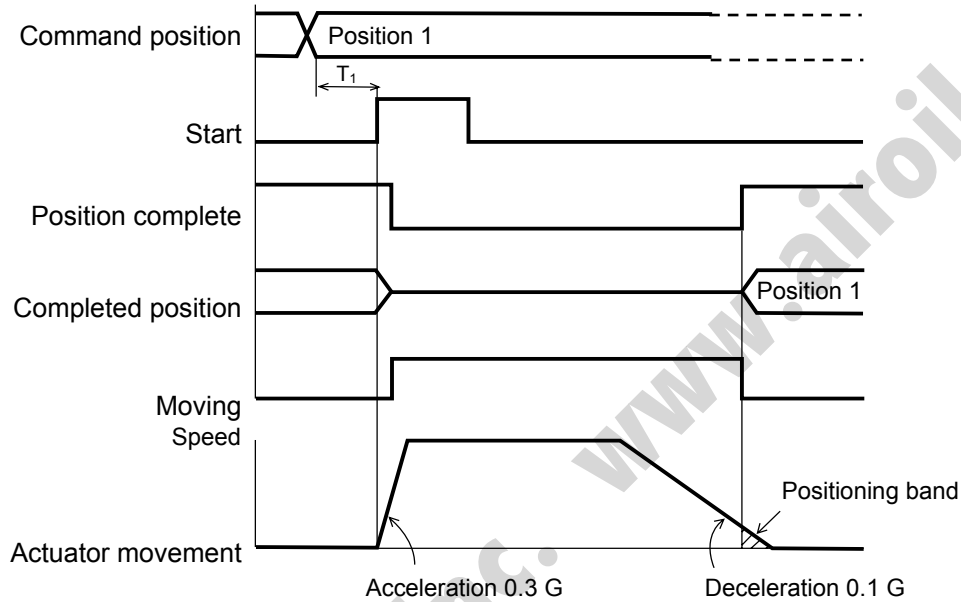

T1: 6 msec or more; time after selecting/entering a command position until the start input turns ON (The scan time of the host controller must be considered.)

**Caution:** When the start signal turns ON, the position complete output will turn OFF and the moving output will turn ON. Always turn OFF the start signal after confirming that the start signal is currently ON and the position complete output has turned OFF. If the start input remains ON as shown below, the position complete output will not turn ON even when the actuator movement is completed.

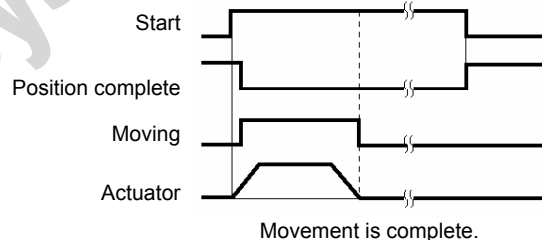

- If another movement command to the same position is issued, the position complete output will turn OFF, but the moving output will not turn ON.
- If the position complete signal turns ON, the moving output will also turn OFF simultaneously even when the actuator is moving. This means that, if the positioning band in the position data is increased, there may be cases where the actuator will continue to move after the moving output turns OFF simultaneously when the position complete output turns ON.
- When a software stroke limit is reached after continuous incremental moves, the actuator will stop immediately and a position complete signal will be output.

## 7.7 Pause

Example of use in operation) Pause the actuator during movement. [Effective in PIO pattern = 0 to 4]  
 Method) Use the pause input.

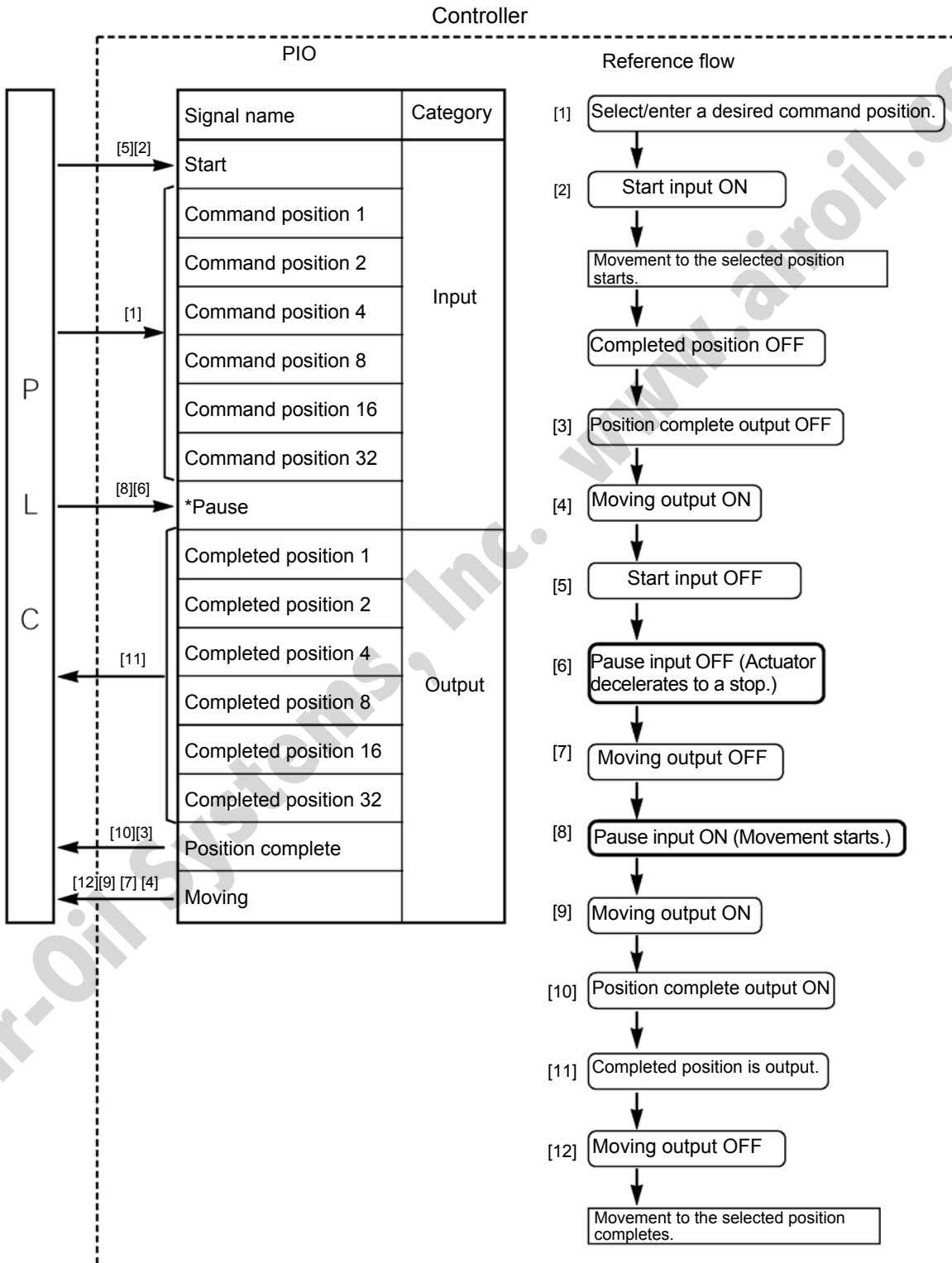

# P CON

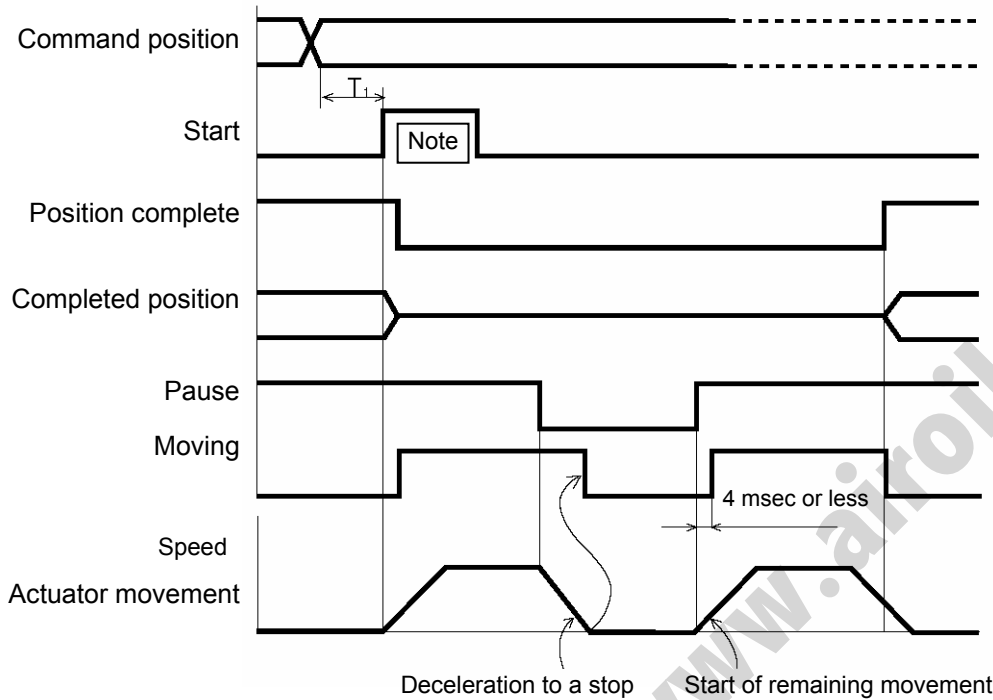

T1: 6 msec or more; time after selecting/entering a command position until the start input turns ON  
(The scan time of the host controller must be considered.)

**Caution:** When the start signal turns ON, the position complete output will turn OFF and the moving output will turn ON.  
Always turn OFF the start signal after confirming that the start signal is currently ON and the position complete output has turned OFF.

The remaining movement can be cancelled by turning ON the reset input during pause.  
(The controller will detect a rise of the reset signal and cancel the remaining movement.)

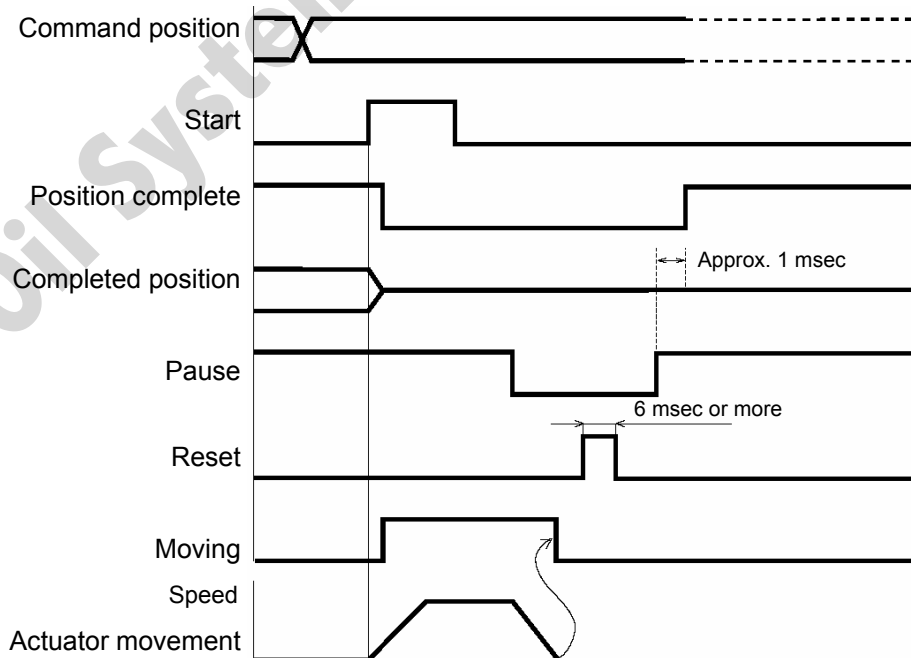

## 7.8 Zone Signal Output

Two types of zone output signals are available: zone output (ZONE1) and position zone output (PZONE). The boundaries defining the signal ON range are set differently for each zone output.

[1] Zone output (ZONE1) --- Set by parameter No. 1/No. 2.

[2] Position zone output (PZONE) --- Set in the “Zone boundary-“ and “Zone boundary+“ fields of the position table.

Whether these signals are available or not varies depending on the PIO pattern, as shown below.

O: Available / x: Not available

Signal classification	PIO pattern					
	0	1	2	3	4	5
Zone output (ZONE1)	O	x	x	x	O	O
Position zone output (PZONE)	O	O	O	x	O	O

Example of use in operation) Move the actuator from the home to the 150-mm position (position 1) and output a zone signal once the actuator enters the range between 40 mm and 120 mm.

- Method) • Zone output (ZONE1)  
The signal ON range is set by the “Zone boundary+“ and “Zone boundary-“ parameters.

Parameter No. 1	Zone boundary+	120 (mm)
Parameter No. 2	Zone boundary-	40 (mm)

- Position zone output (PZONE)  
The signal ON range is set in the “Zone boundary+“ and “Zone boundary-“ fields of the position table.

No.	Position [mm]	Zone boundary+ [mm]	Zone boundary- [mm]
0	*	*	*
1	150.00	120.00	40.00





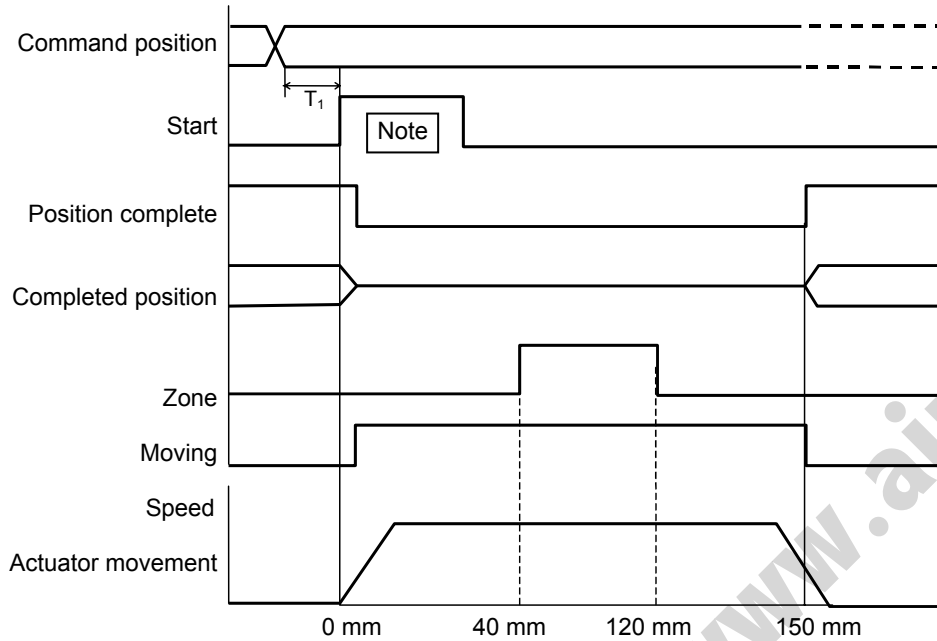

T1: 6 msec or more; time after selecting/entering a command position until the start input turns ON (The scan time of the host controller must be considered.)

Caution: When the start signal turns ON, the position complete output will turn OFF and the moving output will turn ON. Always turn OFF the start signal after confirming that the start signal is currently ON and the position complete output has turned OFF.

Example of other zone output)

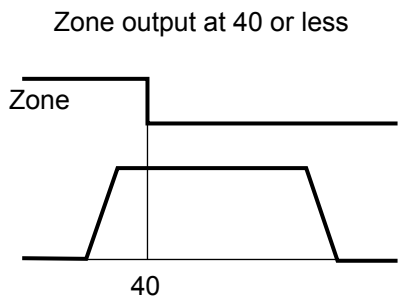
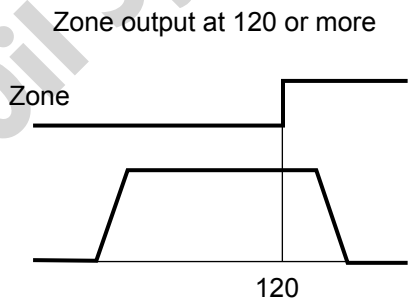

Zone boundary+	Maximum stroke length
Zone boundary-	120

Zone boundary+	40
Zone boundary-	0

## 7.9 Incremental Moves

Example of use in operation) Move the actuator from the home to the 30-mm position by issuing an absolute position command (position No. 1), and thereafter move the actuator continuously at a 10-mm pitch until the final position of 200 mm is reached. (Pitch feed command: Position No. 2)

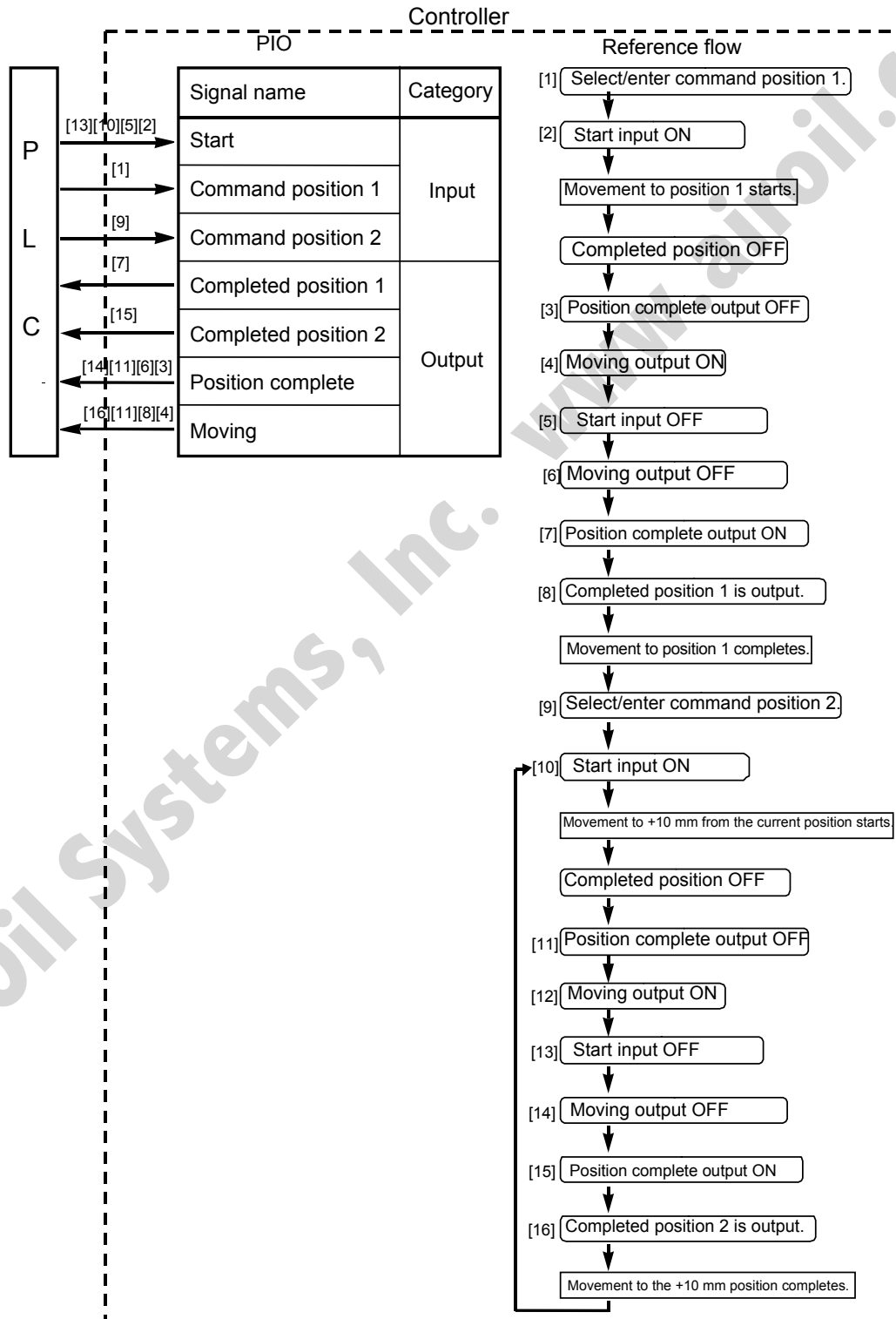

Position table (Field(s) within thick line must be entered.)

No.	Position [mm]	Speed [mm/ss]	Positioning band [mm]	Zone + [mm]	Zone - [mm]	Incremental
0	*	*	*	*	*	*
1	30.00	100.00	0.10	0	0	0
2	10.00	20.00	0.10	190.50	29.50	1
⋮						

Incremental feed

\* On the teaching pendant screen, this sign indicates that the position is specified in the incremental mode.

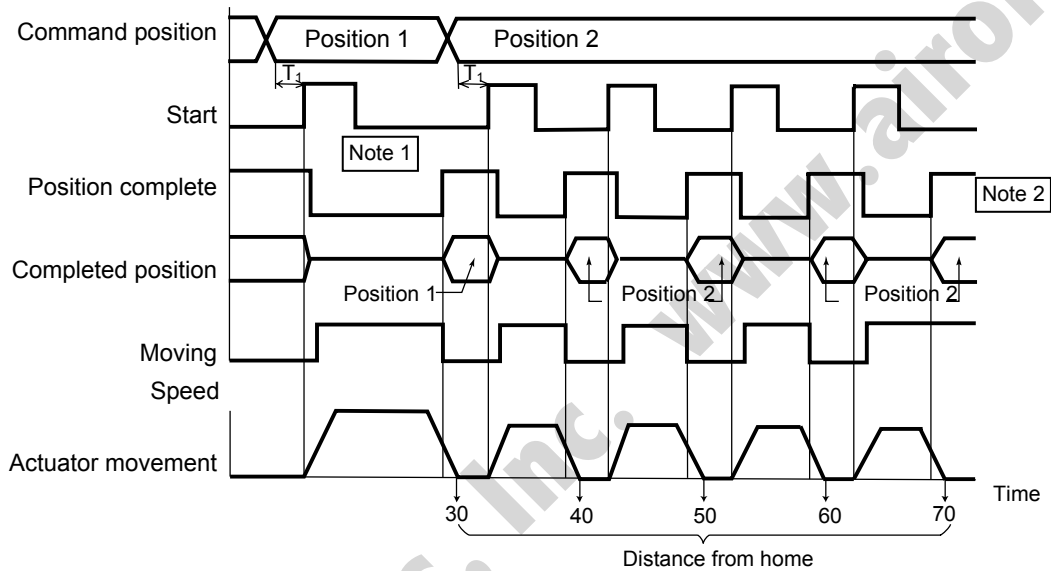

T1: 6 msec or more; time after selecting/entering a command position until the start input turns ON (The scan time of the host controller must be considered.)

**Caution 1:** • When the start signal turns ON, the position complete output will turn OFF and the moving output will turn ON. Always turn OFF the start signal after confirming that the start signal is currently ON and the position complete output has turned OFF.

If the start input remains ON as shown below, the position complete output will not turn ON even when the actuator movement is completed.

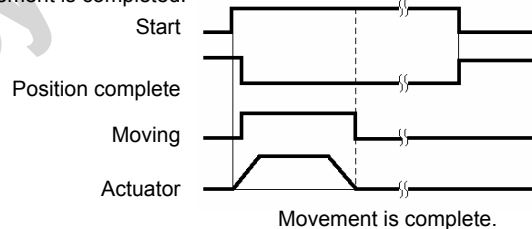

- If another movement command to the same position is issued, the position complete output will turn OFF, but the moving output will not turn ON.
- If the position complete signal turns ON, the moving output will also turn OFF simultaneously even when the actuator is moving. This means that, if the positioning band in the position data is increased, there may be cases where the actuator will continue to move after the moving output turns OFF simultaneously when the position complete output turns ON.
- When a software stroke limit is reached after continuous incremental moves, the actuator will stop immediately and a position complete signal will be output.

**Caution 2:** • When a soft limit is reached as a result of repeated incremental moves, the actuator will stop at that position and the position complete output will be output.

## 7.9.1 Judgment Method of End Position

Although completion judgment is based on the applicable count managed by the PLC, the zone output signal can be used additionally to double-check the completion of movement.

Program the PLC so that the ON/OFF status of the zone output signal is checked when positioning is completed, and if the signal is OFF, the applicable position will be determined as the last load position. If the count in the PLC does not match the zone output signal status, signal timings may not be synchronized.

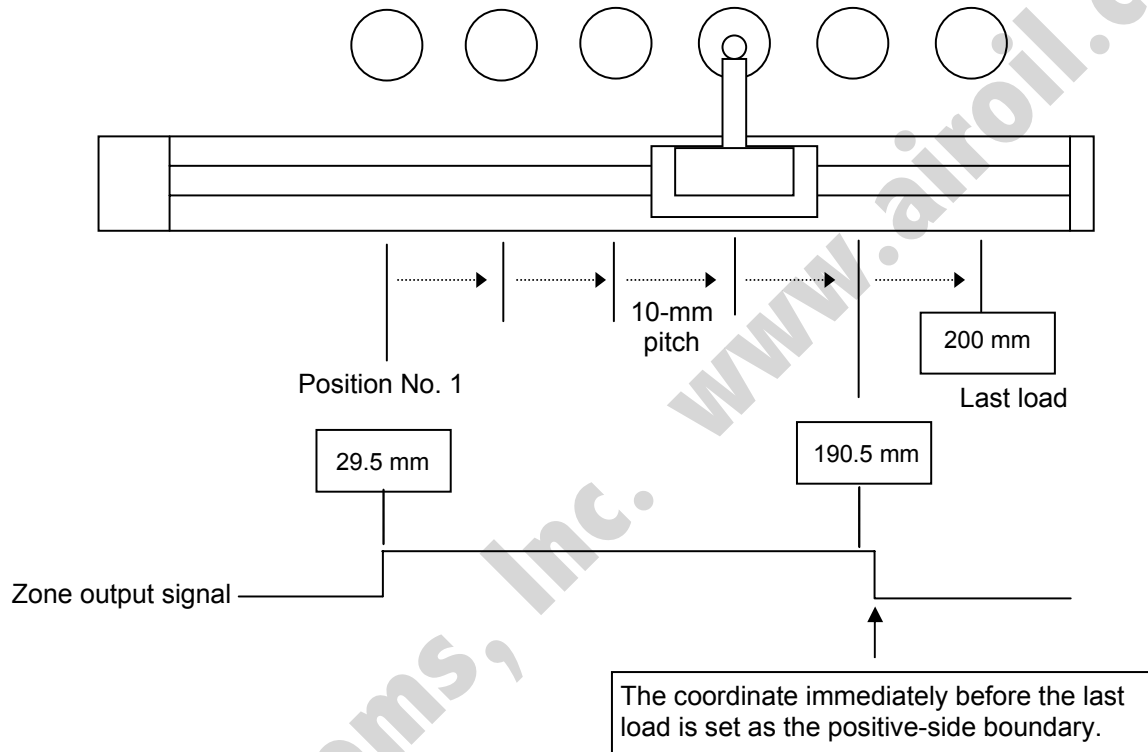

## 7.9.2 Notes on Incremental Mode

If an operation command is issued based on relative coordinate specification while the actuator is moving (in the normal positioning mode or push & hold mode), how the actuator will operate varies depending on whether or not push action is specified in the operation command by relative coordinate specification, as explained below.

- (1) When the relative coordinate operation command specifies an operation in the normal positioning mode (without push action)
- [1] When a relative coordinate operation command is specified while the actuator is moving in the normal positioning mode

If any incremental position number is selected and input and then a start signal is input while positioning is in progress, the actuator will move to the position corresponding to the target position of the initial command plus the incremental distance.

(If the incremental distance is a negative value, the actuator will move to the position corresponding to the target position minus the incremental distance.)

Example) If the start signal for movement to position 2 is input while the actuator is moving to position 1, the actuator will move to the position 215 mm from the home.

Position table (Field(s) within thick line must be entered.)

No.	Position [mm]	Speed [mm/ss]	Positioning band [mm]	Push [%]	Incremental
0	*	*	*	*	*
1	200.00	100.00	0.10	0	0
2	<b>15.00</b>	<b>20.00</b>	0.10	0	<b>1</b>
⋮					

Positioning mode  
Incremental feed

\* On the teaching pendant screen, this sign indicates that the position is specified in the incremental mode.

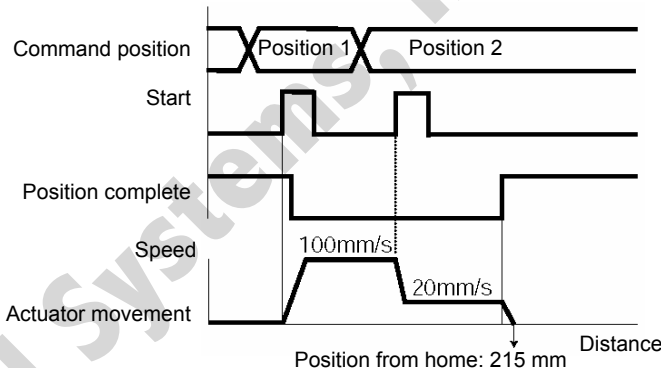

If the start signal for movement to an incremental position number is input multiple times during positioning, the actuator will move to the position corresponding to the initial position plus the "increment x number of times the signal was input."

Example) If the start signal for movement to position 2 is input twice while the actuator is moving to position 1, the actuator will move to the position 230 mm from the home.

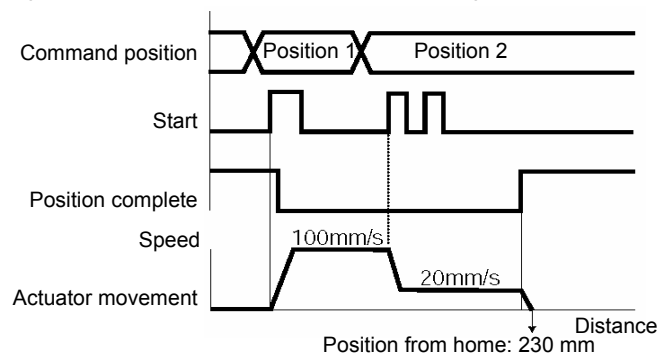

[2] When a relative coordinate operation command is specified while the actuator is moving in the push & hold mode

The following explains how the actuator will move if an incremental position number is selected and input and then a start signal is input while the actuator is moving in the push & hold mode.

Example) If the start signal for movement to position 2 is input while the actuator is moving to position 1, the actuator will move to the position corresponding to the target position set in the position 1 data plus the incremental distance. Accordingly, the push & hold mode will be cancelled. If the position table is set as follows, the actuator will move to the 215-mm position.

Position table (Field(s) within thick line must be entered.)

No.	Position [mm]	Speed [mm/ss]	Positioning band [mm]	Push [%]	Incremental
0	*	*	*	*	*
1	200.00	100.00	30.00	50	0
2	<u>15.00</u>	<u>20.00</u>	<u>0.10</u>	<u>0</u>	<u>1</u>
⋮					

Push & hold mode  
Incremental feed

\* On the teaching pendant screen, this sign indicates that the position is specified in the incremental mode.

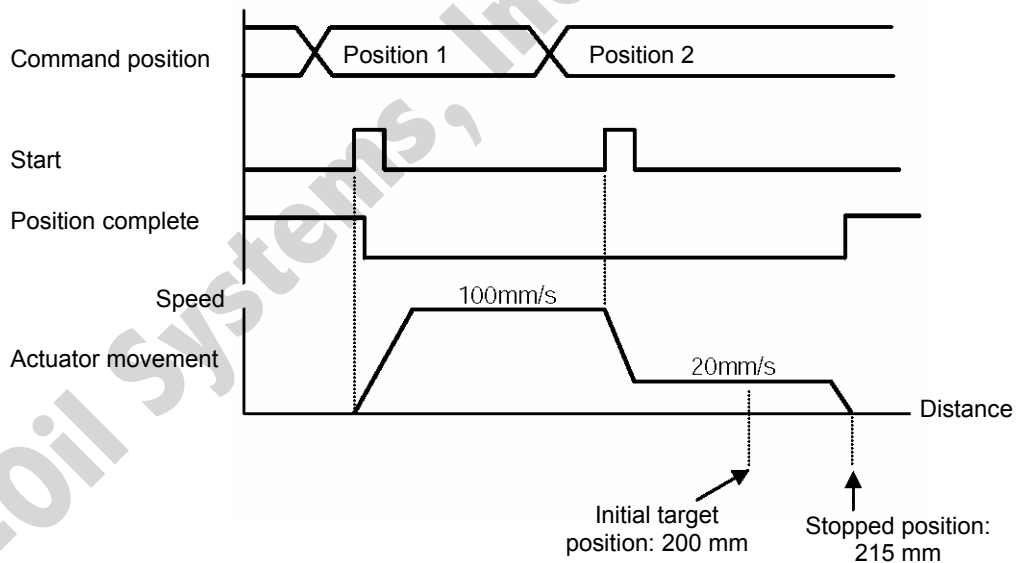

(2) When the relative coordinate operation command specifies an operation in the push & hold mode

Example) If a position 2 command is input followed by a start signal while the actuator is moving to position 1, a new target position will be set by adding the incremental distance to the current position where the start input was received. Since the target position is indeterminable, never use this method.

Position table (Field(s) within thick line must be entered.)

No.	Position [mm]	Speed [mm/ss]	Positioning band [mm]	Push [%]	Incremental
<b>0</b>	*	*	*	*	*
<b>1</b>	200.00	100.00	30.00	50	<b>0</b>
<b>2</b>	<u>15.00</u>	<u>20.00</u>	<u>60.00</u>	<u>50</u>	<u>1</u>
⋮					

Push & hold mode  
Incremental feed

\* On the teaching pendant screen, this sign indicates that the position is specified in the incremental mode.

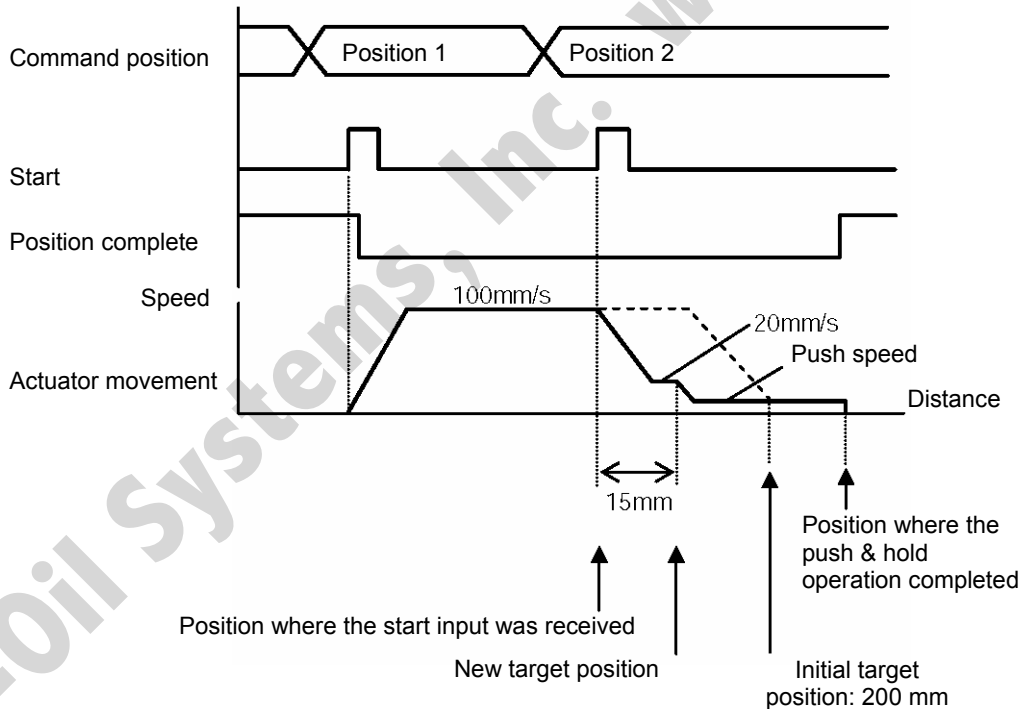

The operation explained above also applies to cases where the operation mode of the position 1 data is the normal positioning mode (without push action).



## 7.10 Jogging/Teaching Using PIO

If the teaching type is selected, you can jog the actuator via operation from the PLC.

You can also write the current actuator position to the “Position” field of the position table under a specified position number via operation from the PLC.

If the actuator position is written to a blank “Position” field where no position has yet been defined, the positioning band and other fields will be automatically populated by their default values set in the applicable parameters.

Example of use in operation) Move the actuator to the target position by inputting a jog command from the PLC and write the achieved position to position No. 1.

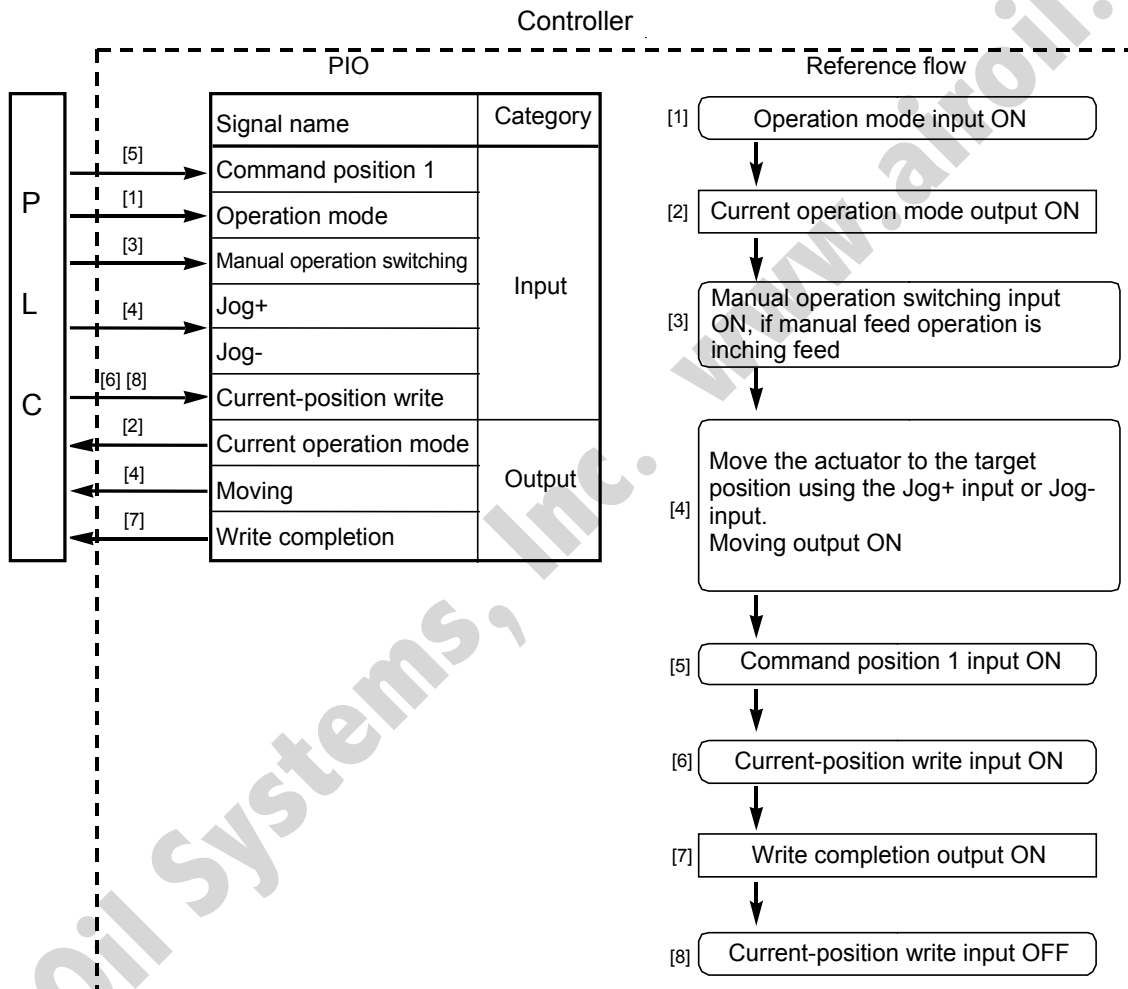

## Jogging/teaching timing

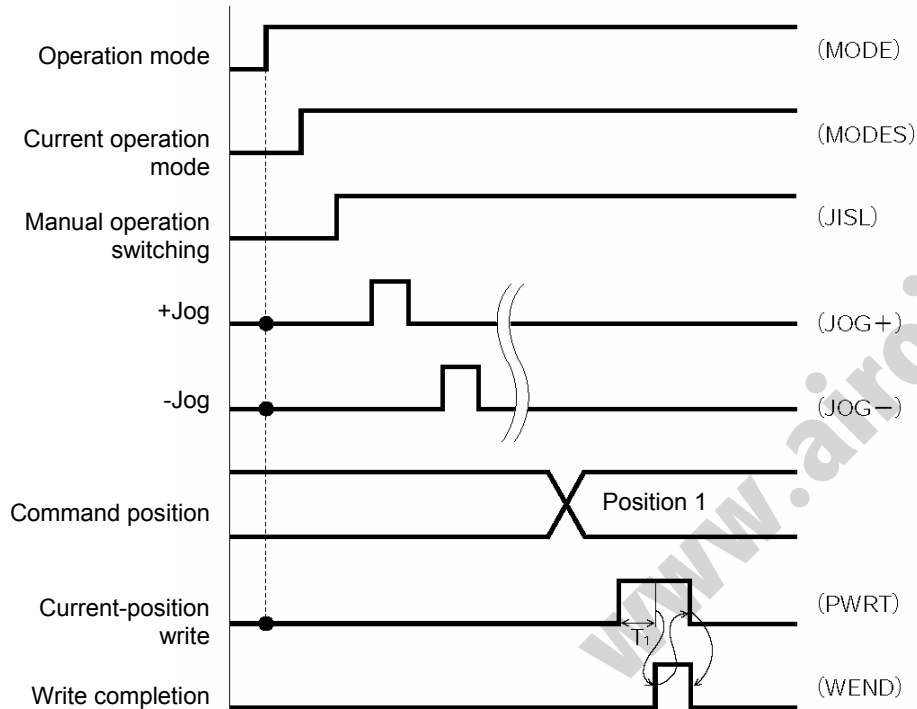

T1: 20 msec or more; time after the current-position write input is turned ON until writing of the current position is started

When the operation mode (MODE) input is turned ON, the current operation mode (MODES) output will turn ON and the teaching mode permitting PIO teaching will become effective. The teaching mode will not become effective unless the operation mode (MODE) input is turned ON while the actuator is stopped.

To confirm that the teaching mode is effective, check if the current operation mode (MODES) output is ON.

If both the Jog+ input and Jog- input turn ON at the same time, the actuator will stop. In this case, turn both inputs OFF and then restart jogging.

The manual operation switching (JISL) input is ON during inching and OFF during jogging.

The inching distance is set by parameter No. 48, while the jog speed is set by parameter No. 26.

If the current-position write (PWRT) input has remained ON for 20 msec or longer, the current actuator position will be written to the selected command position number.

When writing is completed, the write complete (WEND) output will turn ON.

When the current-position write (PWRT) input is subsequently turned OFF, the write complete (WEND) output will turn OFF.

If a signal to be written is input from the PLC while the position table screen is open on the PC or teaching pendant, the position data display will not be refreshed. Perform one of the following operations to check the retrieved position data:

PC --- Click the  button.

Teaching pendant --- Open the user adjustment screen and enter "4" as the adjustment number to reset the software.

## 7.11 Operation in 7-point Type

Separate movement command inputs are provided for the target positions for position Nos. 0 to 6, so simply turn ON the input signal corresponding to the position you wish to move the actuator to, and the actuator will start moving.

Example of use in operation) Move the actuator to position No. 0 (5 mm), position No. 1 (200 mm) and position No. 2 (390 mm) in sequence.

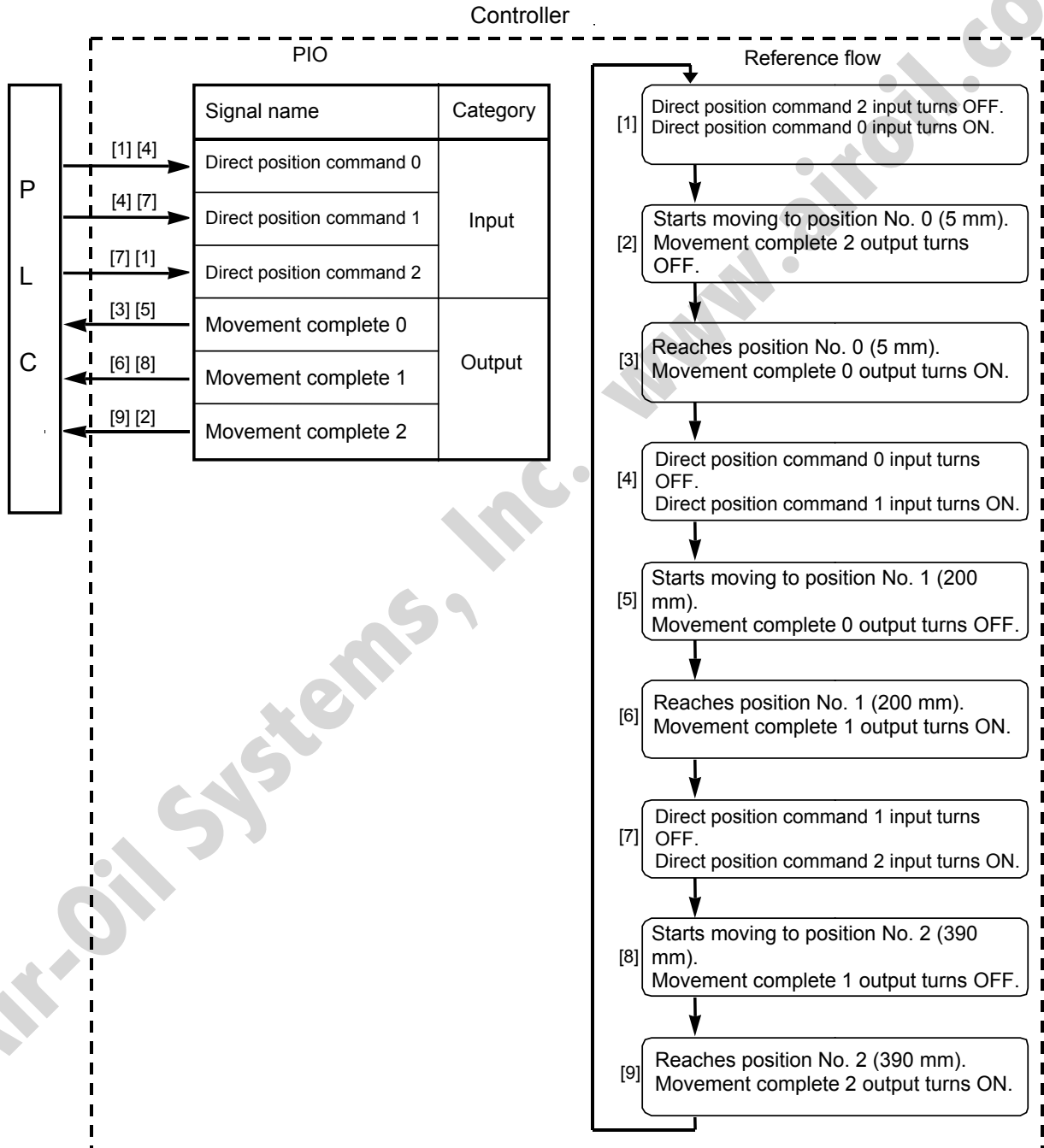

# P CON

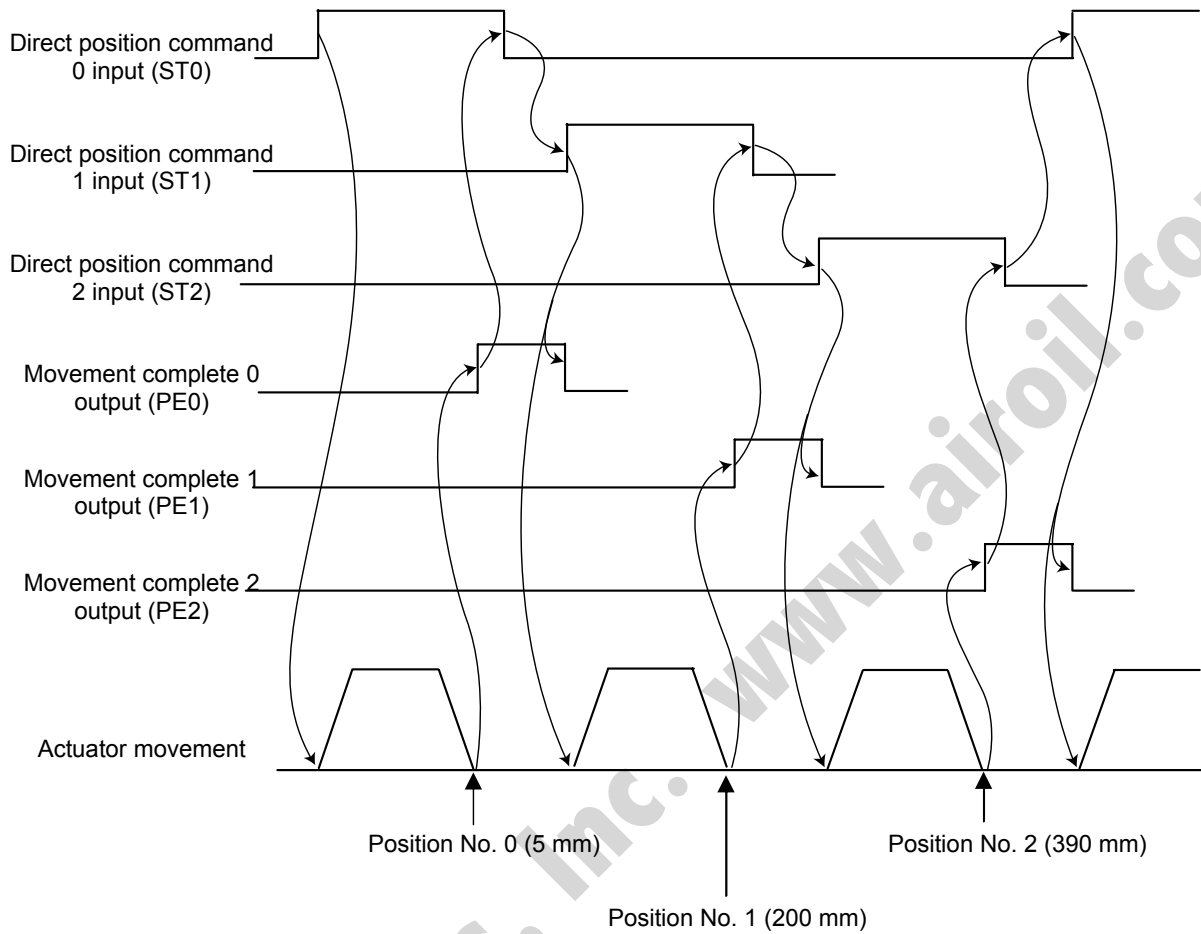

**Caution:** Movement commands are executed based on the rise edge, so input each signal continuously for 6 msec or more.  
If two or more movement commands are input simultaneously, they will be executed according to the following priorities:  
The priorities follow the command numbers in ascending order: [1] Direct position command 0, [2] Direct position command 1, ..., [7] Direct position command 6.  
The sequence circuit on the PLC side must ensure only one command is input at a time.

# P CON

- The movement command input operates in two modes.  
You can select the operation condition of the movement command input (ST0 to ST6) in parameter No. 27.  
The factory setting is “0: [Level mode].”

Description of the movement command input	Setting
<b>Level mode:</b> The actuator starts moving when the input signal turns ON. When the signal turns OFF during the movement, the actuator will decelerate to a stop and complete its operation.	0
<b>Edge mode:</b> The actuator starts moving when the rise edge of the input signal is detected. The actuator will not stop even when the signal turns OFF during the movement, until the target position is reached.	1

## [Level mode]

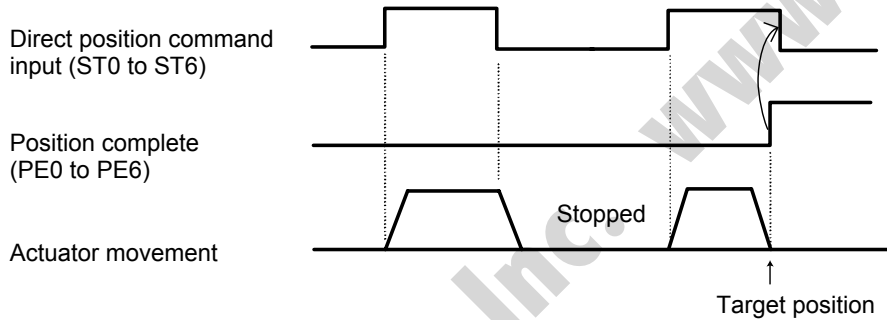

(Note) Turn OFF the movement command input after confirming that the target position has been reached.

## [Edge mode]

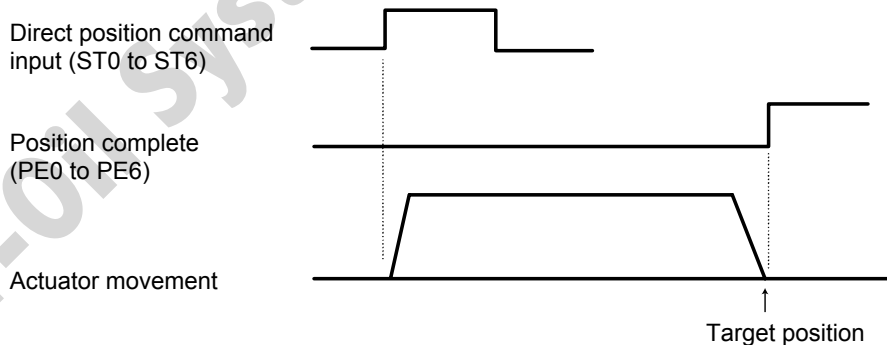

# P CON

- Handling of the pause (\*STP) signal

This signal is a contact B signal, meaning that it must remain ON while the actuator is moving. If the pause signal turns OFF while the actuator is moving, the actuator will decelerate to a stop. The actuator will start moving when the signal turns ON again. Use this signal as an interlock that actuates when an operator entry prohibition sensor or contact prevention sensor is activated.

If the pause signal is not to be used, set parameter No. 15 (Pause input disable selection) to "1," and the actuator will move even when this signal is OFF.

(Note) When the "edge mode" is selected as the movement command type, you can change the target position while the actuator is stopped with this signal turned OFF, as follows:

- [1] Input a reset signal (RES) for 6 msec or more to cancel the remaining travel. Next, turn ON the pause signal, and then input a movement command specifying the new target position.

(Example) Turn OFF the pause signal while the actuator is moving under direct position command

1. The actuator decelerates to a stop.
  - Turn OFF direct position command 1, and turn ON the reset signal for 6 msec or more.
  - Turn ON the pause signal again, and input direct position command 2.

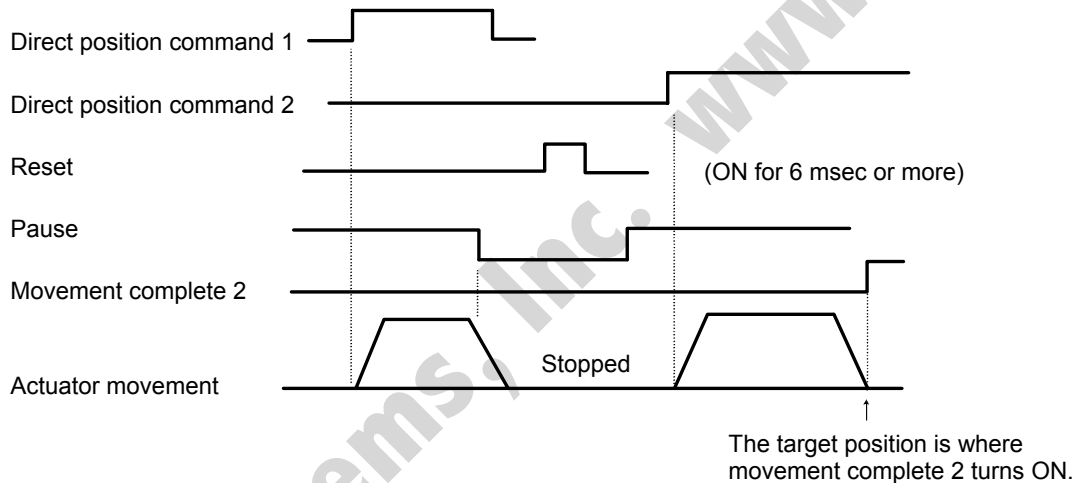

- [2] After inputting a movement command specifying the new target position, turn ON the pause input.
- (Example) Turn OFF the pause signal while the actuator is moving under direct position command

1. The actuator decelerates to a stop.
  - Turn OFF direct position command 1, and turn ON direct position command 2.
  - Turn ON the pause signal again. The front end is recognized as the new target position.

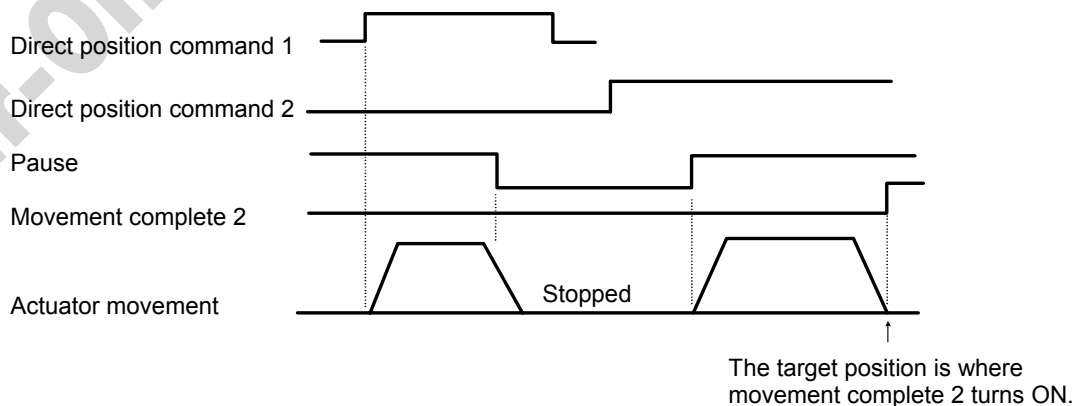

## 7.12 Operation in 3-point Type

After the power has been turned on, input the rear end move command first to complete home return, and then perform continuous operation.

→ Refer to 7.2.2, "Method Used When No HOME Input Signal Is Available."

Example of use in operation) How to move the actuator from the rear end to the front end is explained.

Although the actuator does not stop at the intermediate point, you can increase the positioning band and use the intermediate point detected output signal (LS2) as a quasi zone output signal.

Example of position table

No.	Position [mm]	Speed [mm/s]	Acceleration [G]	Deceleration [G]	Push [%]	Positioning band [mm]	Remarks
0	5.00	300.00	0.30	0.30	0	0.10	Rear end
1	380.00	300.00	0.30	0.30	0	0.10	Front end
2	200.00	300.00	0.30	0.30	0	50.00	Intermediate point

### Operation timings

**PLC processing 1:** Turn OFF the rear end move command signal (ST0) and intermediate point move command signal (ST2), and turn ON the front end move command signal (ST1).

**Operation:**

- [1] The actuator starts moving toward the front end.
- [2] When the current position passes 5.1 mm, the rear end detected output (LS0) turns OFF.
- [3] When the current position reaches 150 mm, the intermediate point detected output (LS2) turns ON. Once 250 mm is passed, LS2 turns OFF.

**PLC processing 2:** If necessary, use the intermediate point detected output (LS2) as a trigger signal with respect to surrounding equipment.

- [4] When the current position reaches 379.9 mm, the front end detected output (LS1) turns ON.

- [5] When the current position reaches 380 mm, the actuator stops.

**PLC processing 3:** Once the front end detected output (LS1) turns ON, the sequence processing at the front end is executed. Upon completion of the sequence processing, the front end move command signal (ST1) turns OFF.

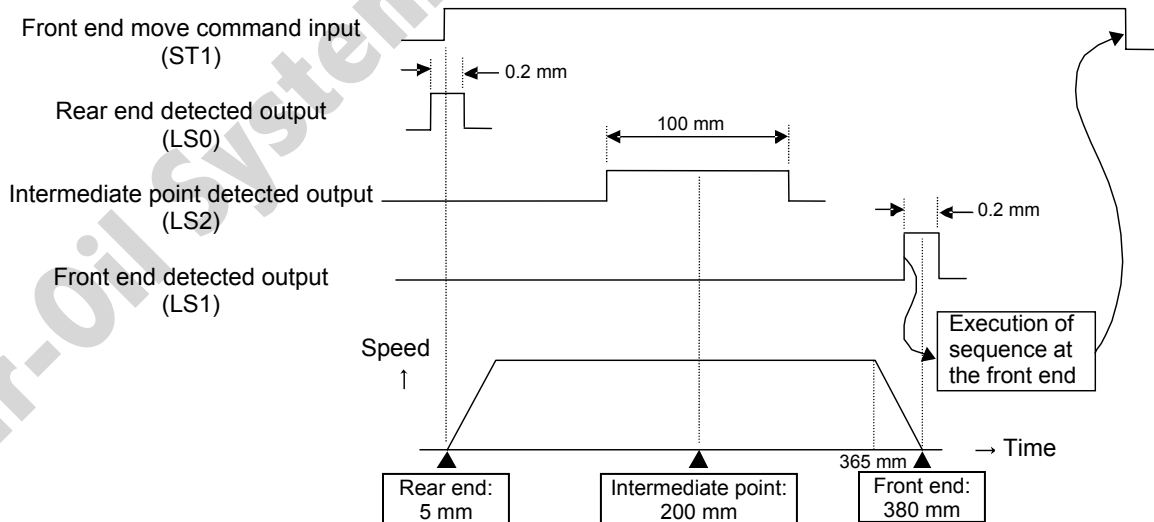

**⚠ Caution:** Provide a ladder sequence circuit where only one move command signal turns ON at a time. If two or more signals are input at the same time, the signals will be processed in the following priorities:  
 Priorities: [1] Rear end, [2] Front end, [3] Intermediate point

- Meaning of position detected output signals (LS0, LS1, LS2)  
These signals are handled in the same manner as limit switches (LSs), and turn ON when the following conditions are met:

- [1] The home return complete output signal (HEND) is ON.
- [2] The current position is within the positioning band from each target position in the positive or negative direction.

Accordingly, these signals turn ON not only when the actuator is moving under a move command, but also when the actuator is moved by hand with the servo turned off.

In a case where none of these signals (LS0, LS1, LS2) is ON when an emergency stop was actuated while the actuator was moving, if LS0, LS1 or LS2 must be ON as a condition for resuming actuator operation from the PLC, move the actuator to any target position.

⚠ Caution: These signals will turn OFF if a phase-A/B disconnection detection alarm occurs.

- Notes on positioning band setting  
The positioning band setting defines the range within which the position detected output signal turns ON.

Condition for the position detected output signal to turn ON = Target position ± (Positioning band)

With any normal move command, once the position detected output signal turns ON the sequence processing will be executed and the move command input signal will turn OFF.

Take note that if the positioning band is wide and the move command input signal turns OFF quickly, the actuator may not reach the target position.

(Example) When the feed speed is 300 mm/s and deceleration is 0.3 G, the deceleration distance becomes approx. 15 mm.

If the positioning band is set to 30 mm, the position detected output signal will turn ON before the actuator starts decelerating.

In this case, promptly turning OFF the move command input signal on the PLC will cause the controller to initiate the deceleration stop processing.

Depending on the timing, therefore, the actuator may stop before the target position.

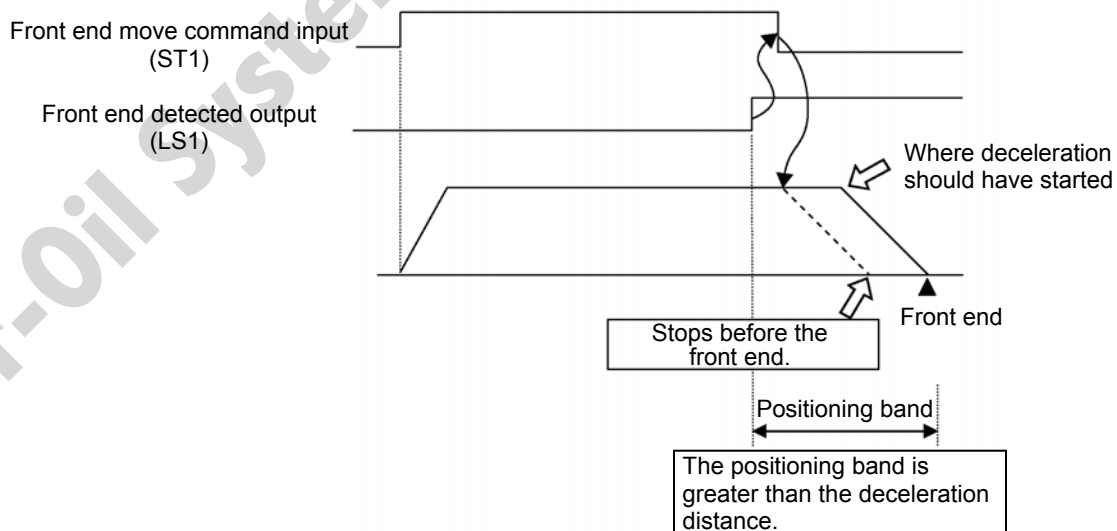



- Speed change during movement

If the load is made of soft material or is a bottle or otherwise topples easily due to its shape, one of the following two methods can be used to prevent the load from receiving vibration or impact when it stops:

- [1] Reduce the deceleration to make the deceleration curve gradual.
- [2] Initially move the actuator at the rated speed, and reduce the feed speed immediately before the target position.

Method [2], where the feed speed is reduced, is explained below.

(Example) Move the actuator from the rear end to the front end by using the intermediate point as a dummy point, where the feed speed is set to 300 mm/s until the intermediate point and then reduced to 20 mm/s after passing the intermediate point.

Example of position table

No.	Position [mm]	Speed [mm/s]	Acceleration [G]	Deceleration [G]	Push [%]	Positioning band [mm]	Remarks
0	5.00	300.00	0.30	0.30	0	0.10	Rear end
1	380.00	20.00	0.30	0.30	0	0.10	Front end
2	300.00	300.00	0.30	0.30	0	30.00	Intermediate point

Operation timings

**PLC processing 1:** Turn OFF the rear end move command signal (ST0) and the front end move command signal (ST1), and turn ON the intermediate point move command signal (ST2).

**Operation:** [1] The actuator starts moving toward the intermediate point.  
[2] When the current position reaches 270 mm, the intermediate point detected output (LS2) turns ON.

**PLC processing 2:** Turn OFF the intermediate point move command signal (ST2) and turn ON the front end move command signal (ST1).  
[3] The actuator decelerates from 300 mm/s to 20 mm/s and stops at the front end.

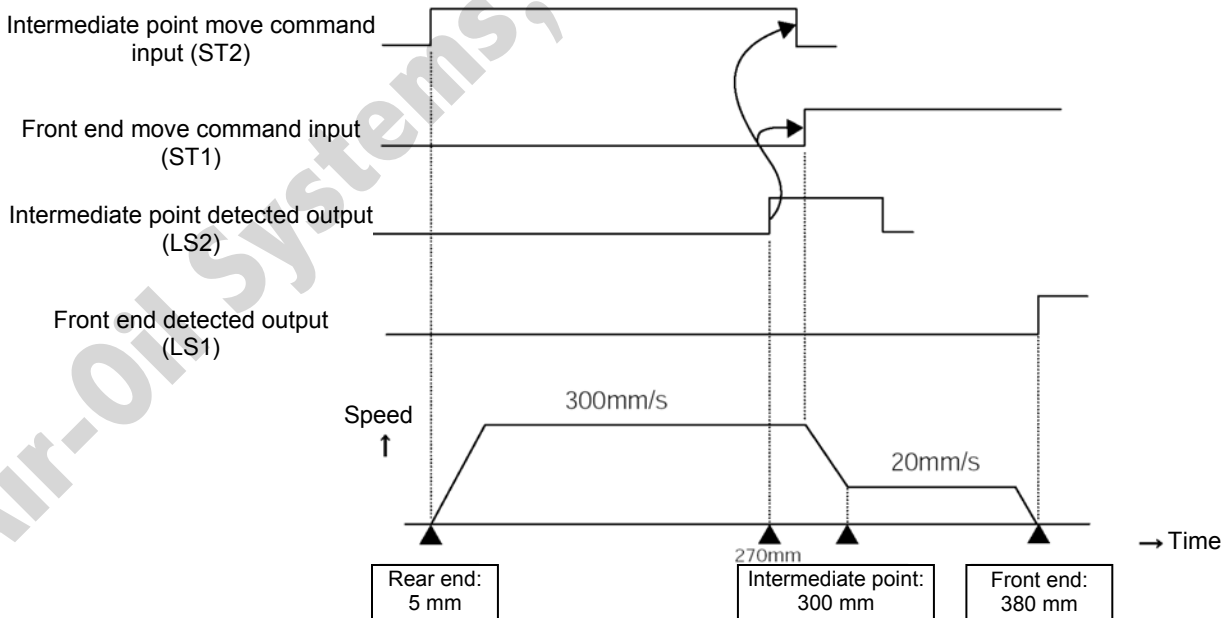

⚠ **Caution:** By setting a wide positioning band for the intermediate point, smooth speed change can be implemented without requiring the actuator to stop temporarily at the intermediate point.

- Pause during movement

Since move commands are based on level mode, the actuator continues to move while a move command is ON. Once the move command turns OFF, the actuator will decelerate to a stop and complete the operation.

Therefore, turn OFF the move command if the actuator must be stopped temporarily as a low-degree safety measure.

(Example) Temporarily stop the actuator while it is moving to the front end.

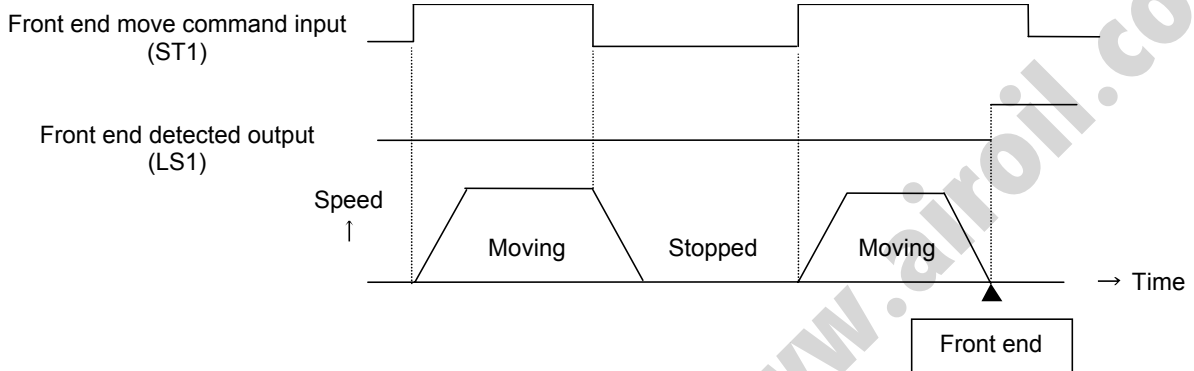

- Emergency return operation

The following explains what to do when an emergency situation occurred while the actuator was moving and you want to return the actuator to the standby position (rear end).

(Example) Return the actuator to the standby position (rear end) following an emergency situation occurring while the actuator was moving to the front end.

Operation timings

PLC processing 1: Turn ON the rear end move command signal (ST0) upon occurrence of the emergency situation, and then turn OFF the front end move command signal (ST1).

Operation:  
 [1] The actuator starts decelerating upon turning OFF of the front end move command signal (ST1), and stops.  
 [2] The actuator reverses its direction and starts moving toward the rear end.  
 [3] When the rear end is reached, the rear end position complete output (PE0) turns ON.

PLC processing 2: Turn OFF the rear end move command signal (ST0).

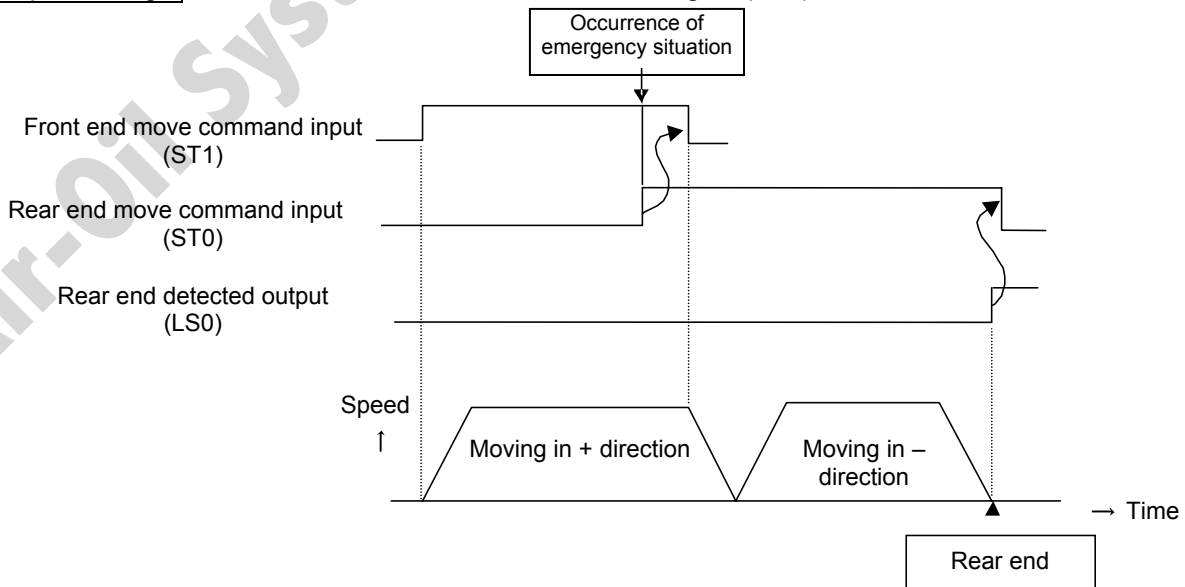

## 8. Parameters

### 8.1 Parameter Table

Category: a: Parameter relating to the actuator stroke range  
 b: Parameter relating to the actuator operating characteristics  
 c: Parameter relating to the external interface  
 d: Servo gain adjustment

No.	Category	Symbol	Name	Unit	Default factory setting
1	a	ZONM	Zone boundary 1+	mm	Effective actuator length
2	a	ZONL	Zone boundary 1-	mm	Effective actuator length
3	a	LIMM	Soft limit+	mm	Effective actuator length
4	a	LIML	Soft limit-	mm	Effective actuator length
5	a	ORG	Home return direction [0: Reverse / 1: Forward]	-	(In accordance with the specification at the time of order)
6	b	PSWT	Push & hold stop judgment period	msec	255
7	d	PLG0	Servo gain number	-	6
8	b	VCMD	Default speed	mm/sec	Set individually in accordance with the actuator characteristics.
9	b	ACMD	Default acceleration/deceleration	G	Set individually in accordance with the actuator characteristics.
10	b	INP	Default positioning band (in-position)	mm	Set individually in accordance with the actuator characteristics.
12	b	SPOW	Current-limiting value at standstill during positioning	%	60
13	b	ODPW	Current-limiting value during home return	%	Set individually in accordance with the actuator characteristics.
16	c	BRSL	SIO communication speed	bps	38400
17	c	RTIM	Minimum delay time for slave transmitter activation	msec	5
18	b	LS	Home sensor input polarity	-	Set individually in accordance with the actuator characteristics.
21	c	SON	Servo ON input [0: Enable / 1: Disable]		1
22	a	OFST	Home return offset	mm	Set individually in accordance with the actuator characteristics.
23	a	ZNM2	Zone boundary 2+	mm	Effective actuator length
24	a	ZNL2	Zone boundary 2-	mm	Effective actuator length
25	c	IOPN	PIO pattern selection	-	0 [Standard type]
26	b	IOJV	PIO jog speed	mm/sec	100
27	c	FPIO	Movement command type [0: Level / 1: Edge]	-	0 [Level]
28	b	PHSP	Default direction of excited-phase signal detection [0: Reverse / 1: Forward]		Set individually in accordance with the actuator characteristics.
29	b	PHSP	Excited-phase signal detection time	msec	Set individually in accordance with the actuator characteristics.
31	d	VLPG	Speed loop proportional gain	-	Set individually in accordance with the actuator characteristics.
32	d	VLPT	Speed loop integral gain	-	Set individually in accordance with the actuator characteristics.
33	d	TRQF	Torque filter time constant	-	Set individually in accordance with the actuator characteristics.
34	b	PSHV	Push speed	mm/sec	Set individually in accordance with the actuator characteristics.
35	b	SAFV	Safety speed	mm/sec	100
36	b	ASO1	Automatic servo-off delay time 1	sec	0
37	b	ASO2	Automatic servo-off delay time 2	sec	0
38	b	ASO3	Automatic servo-off delay time 3	sec	0
39	c	FPIO	Output mode of position complete signal [0: PEND / 1: INP]	-	0 [PEND]
40	c	HOME	Home-return input disable selection [0: Enable / 1: Disable]	-	0 [Enable]

# P CON

No.	Category	Symbol	Name	Unit	Default factory setting
41	c	FPIO	Operating-mode input disable selection [0: Enable / 1: Disable]	-	0 [Enable]
42	b	ENBL	Enable function [0: Enable/1: Disable]	-	1 [Disable]
43	b	HMC	Polarity of home check sensor input [0: Contact a / 1: Contact b]	-	Set individually in accordance with the actuator characteristics.
45	c	SIVM	Silent interval multiplier	-	0 [Do not apply multiplier]
46	b	OVRD	Speed override	%	100
47	b	IOV2	PIO jog speed	mm/sec	100
48	b	IOID	PIO inching distance	mm	0.1
49	b	IOD2	PIO inching distance 2	mm	0.1
50	b	LDWT	Load output judgment time	msec	0
51	b	TRQZ	Torque check range [0: Enable / 1: Disable]	-	0 [Enable]
77	b	LEAD	Ball screw lead	mm	Set individually in accordance with the actuator characteristics.
78	b	ATYP	Axis operation type	-	Set individually in accordance with the actuator characteristics.
79	b	ATYP	Rotational axis mode selection	-	Set individually in accordance with the actuator characteristics.
80	b	ATYP	Shortcut selection for rotation	-	Set individually in accordance with the actuator characteristics.
86	b	ETYP	Absolute unit [0: Not used / 1: Used]	-	Set individually in accordance with the actuator characteristics.

## 8.2 Detail Explanation of Parameters

If a parameter has been changed, always restart the controller using a software reset command or by reconnecting the power.

### 8.2.1 Parameters Relating to the Actuator Stroke Range

- Soft limit (No.3/4 LIMM/LIML)

Set the soft limit in the positive direction in parameter No. 3, and that in the negative direction in parameter No. 4.

The factory setting for the soft limits conforms to the effective actuator length. Change the settings, as necessary, to prevent crash with an obstacle or when the actuator must be stroked slightly beyond its effective length.

A wrong soft limit setting will cause the actuator to crash into the mechanical end, so exercise due caution. The minimum setting unit is "0.01 [mm]."

(Note) To change a soft limit, set a value corresponding to 0.3 mm outside of the effective range.

Example) Set the effective range to between 0 mm and 80 mm

Parameter No. 3 (positive side) 80.3

Parameter No. 4 (negative side) -0.3

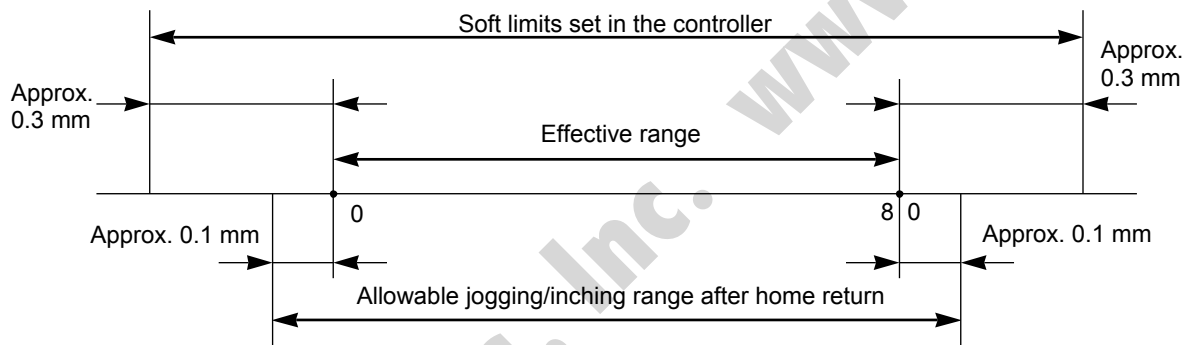

- Zone boundary (1: No.1/2 ZONM/ZONL 2: No.23/24 ZNM2/ZNL2)

These parameters set the zone within which the zone output signal (ZONE1) turns ON when the selected PIO pattern is "0" (standard type), "4" (7-point type) or "5" (3-point type).

The zone output signal turns ON when the current position is between the negative-side boundary and positive-side boundary. Set the positive-side boundary in parameter No. 1, and negative-side boundary in No. 2.

The minimum setting unit is "0.01 [mm]."

Example) To turn ON the ZONE1 signal when the actuator with a 300-mm stroke enters the section of 100 to 200 mm, set 200.00 in parameter No. 1 (Zone boundary+) and 100.00 in parameter No. 2 (Zone boundary-).

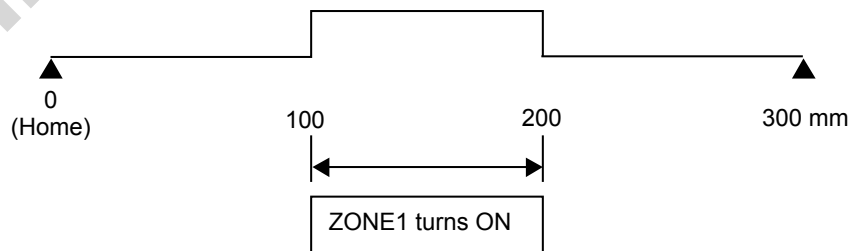

(Note) This controller does not use parameter No. 23 (Zone boundary 2+) and parameter No. 24 (Zone boundary 2-).

- Home return direction (No.5 ORG)

Unless specified by the user, the home return direction is set to the motor direction at the factory. Should a need arise to change the home direction after the actuator has been assembled into your system, reverse the setting in parameter No. 5 between “0” and “1.”

If necessary, also change the home return offset, soft limit and excited-phase signal detection direction parameters.

Caution: The home direction cannot be reversed for a rod-type actuator.

- Home return offset (No.22 OFST)

The controller is shipped from the factory with an optimal value set in parameter No. 22, so the distance from each mechanical end to the home becomes uniform.

The minimum setting unit is “0.01 [mm].”

The home return offset can be adjusted in the following conditions:

- [1] Want to align the actuator home and the system’s mechanical home after the actuator has been assembled into the system
- [2] Want to set a new home after reversing the factory-set home direction
- [3] Want to eliminate a slight deviation generated after replacing the actuator

Caution: If the home return offset has been changed, the soft limit parameters must also be adjusted accordingly.

## 8.2.2 Parameters Relating to the Actuator Operating Characteristics

- PIO jog speed (No.26 IOJV)

When the selected PIO pattern is “1” (teaching type), this parameter defines the jog speed to be applied when jog input commands are received from the PLC.

The factory setting is “100 [mm/sec].”

Set an appropriate value in parameter No. 26 in accordance with the purpose of use.

The maximum speed is limited to “250 [mm/sec].”

(Note) Parameter No. 47 (PIO jog speed 2) is not used for this controller.

- PIO inching distance (No.48 IOID)

When the selected PIO pattern is “1” (teaching type), this parameter defines the inching distance to be applied when inching input commands are received from the PLC.

The factory setting is “0.1 [mm].”

Set an appropriate value in parameter No. 48 in accordance with the purpose of use.

The maximum limit is limited to “1 [mm].”

(Note) Parameter No. 49 (PIO inching distance 2) is not used for this controller.

- Default speed (No.8 VCMD)

The factory setting is the rated speed of the actuator.

When a target position is set in an unregistered position table, the setting in this parameter will be used as the speed data for the applicable position number.

To reduce the default speed from the rated speed, change the setting in parameter No. 8.

- Default acceleration/deceleration (No.9 ACMD)

The factory setting is the rated acceleration/deceleration of the actuator.

When a target position is written to an unregistered position table or the current position is read in the teaching mode, the setting in this parameter will be used as the acceleration/deceleration data for the applicable position number.

To reduce the default acceleration/deceleration from the rated acceleration/deceleration, change the setting in parameter No. 9.

- Default positioning band (in-position) (No.10 INP)

The factory setting is "0.10 [mm]."

When a target position is written to an unregistered position table or the current position is read in the teaching mode, the setting in this parameter will be used as the positioning band data for the applicable position number.

Increasing the default positioning band will allow the position complete signal to be output early. Change the setting in parameter No. 10, as necessary.

- Current-limiting value at standstill during positioning (No.12 SPOW)

The factory setting conforms to the standard specification of the actuator.

Increasing this setting will increase the holding torque at standstill.

This setting need not be changed in normal conditions of use. However, to prevent hunting caused by large external force applied while the actuator is at standstill, the value set in parameter No. 12 must be increased.

(Do not increase the value beyond 70%.)

- Current-limiting value during home return (No.13 ODPW)

The factory setting conforms to the standard specification of the actuator.

Increasing this setting will increase the home return torque.

This setting need not be changed in normal conditions of use. However, if an increased slide resistance causes the home return to complete before the correct position depending on the affixing method, load condition or other factor when the actuator is used in a vertical application, the value set in parameter No. 13 must be increased.

(As a guide, the maximum limit is 100% for the RA3C/RA3D types and 75% for all other types.)

- Home sensor input polarity (No. 18, LS)

This parameter is supported when a RCP2-RTB/RTC rotational axis is used in the home sensor mode.

Definition of settings : 0 (Sensor not used)

: 1 (Sensor polarity of contact a)

: 2 (Sensor polarity of contact b)

- Speed override (No.46 OVRD)

Use this parameter when moving the actuator at a slower speed to prevent danger when the system is initially started for test operation.

When move commands are issued from the PLC, the moving speed set in the "Speed" field of the position table can be overridden by the value set by parameter No. 46.

Actual moving speed = [Speed set in the position table] x [Value of parameter No. 46] ÷ 100

Example) Value in the "Speed" field of the position table 500 (mm/s)

Value of parameter No. 46 20 (%)

Under the above settings, the actual moving speed becomes 100 mm/s.

The minimum setting unit is "1 [%]," while the input range is "1 to 100 [%]." The factory setting is "100 [%]."

(Note) This parameter is ignored for move commands from the PC and teaching pendant.

- Default direction of excited-phase signal detection (No.28 PHSP)

When the servo is turned on for the first time after the power on, excited-phase detection is performed. This parameter defines the direction of this detection.

The parameter need not be changed in normal conditions. In certain situations, such as when the actuator was contacting a mechanical end or obstacle when the power was turned on and cannot be moved by hand, change the direction to one that allows the motor to operate smoothly.

To do so, set parameter No. 28 to "0" or "1." If the detection direction should be the same as the home return direction, specify the same value currently set in parameter No. 5 (Home return direction).

To set a direction opposite to the home return direction, specify the value different from the one currently set in parameter No. 5 (Home return direction).

(Example 1) Power was turned on when the slider was contacting the bottom mechanical end in a configuration where the actuator is installed vertically with the motor at the top.

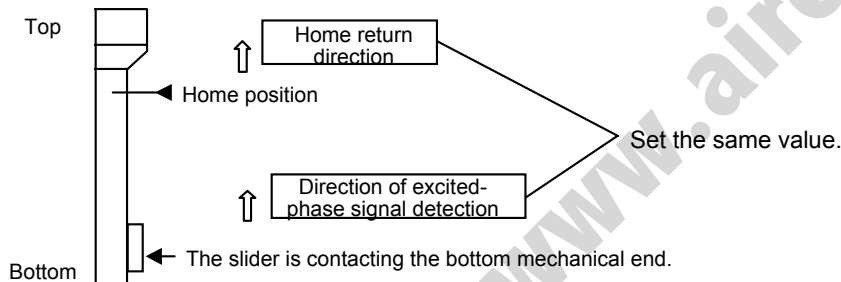

(Example 2) Power was turned on when the slider was contacting the bottom mechanical end in a configuration where the actuator is installed vertically with the motor at the bottom.

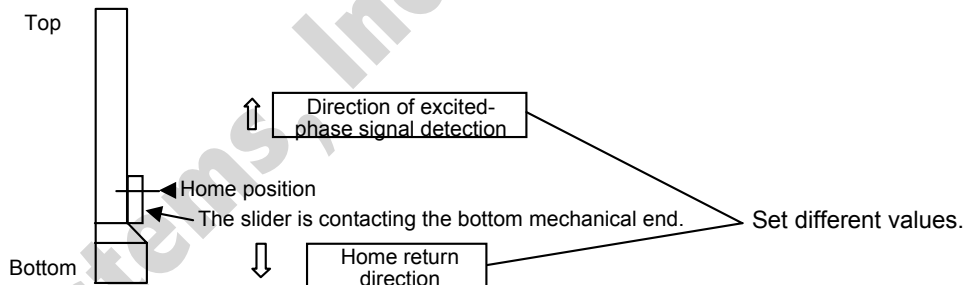

- Excited-phase signal detection time (No.29 PHSP)

When the servo is turned on for the first time after the power on, excited-phase detection is performed. This parameter defines the time of this detection.

The parameter need not be changed in normal conditions, because a detection time appropriate for the standard specification of the actuator has been set at the factory.

Should an excitation detection error or abnormal operation occur when the servo is turned on for the first time after the power on, one remedial action that can be taken is to change the detection time set by parameter No. 29.

If you wish to change this parameter, contact IAI beforehand.

- Safety speed (No.35 SAFV)

This parameter defines the feed speed to be applied during manual operation.

The factory setting is "100 [mm/sec]."

To change this speed, set an optimal value in parameter No. 35.

Take note that the maximum speed is limited to "250 [mm/s]" and that you should set a speed not exceeding this value.



- Automatic servo-off delay time (No.36 ASO1/No.37 ASO2/No.38 ASO3)

This parameter defines the delay time after the positioning is completed until the servo turns off automatically, when the "Standstill mode" field of the position table is set to "1," "2" or "3" (automatic servo-off control enabled) or parameter No. 53 (Default standstill mode) is set to "1," "2" or "3"(automatic servo-off control enabled).

Meaning of settings: 1: T becomes the value set by parameter No. 36.  
 2: T becomes the value set by parameter No. 37.  
 3: T becomes the value set by parameter No. 38.

The factory setting is "0 [sec]."

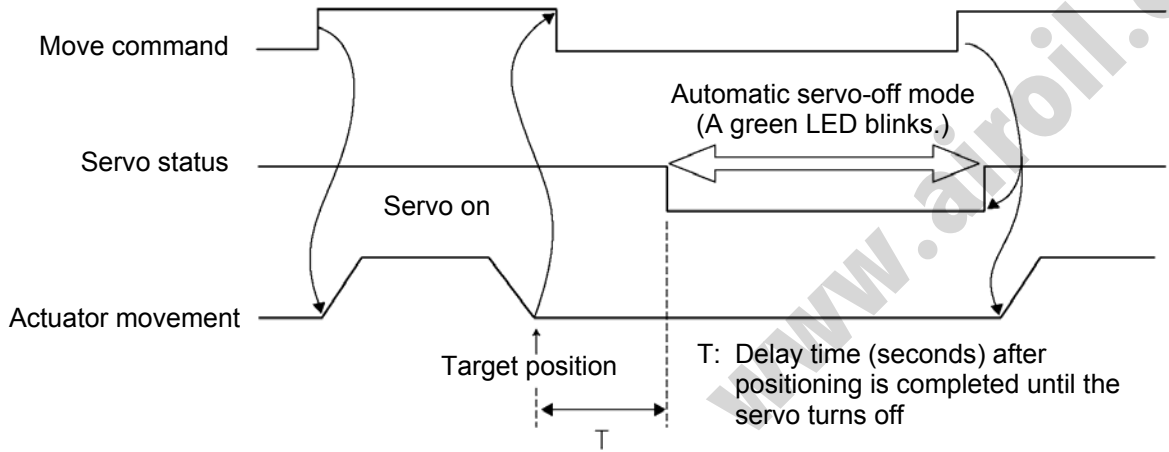

- Default standstill mode (No.35 CTLF)

- [1] In PIO patterns 0 to 4, either the automatic servo-off mode or full servo control mode can be selected when the actuator stands by for a long time after completing the home return effected by the HOME input signal.
  - [2] In PIO pattern 5, the full servo control mode can be selected when the actuator stands by for a long time after the power has been turned on.
- The factory setting is "0 [Disable]."

	Setting
All power-saving modes are disabled.	0
Automatic servo-off mode. The delay time is defined by parameter No. 36.	1
Automatic servo-off mode. The delay time is defined by parameter No. 37.	2
Automatic servo-off mode. The delay time is defined by parameter No. 38.	3
Full servo control mode	4

### Automatic servo-off mode

After positioning is completed, the servo will turn off automatically upon elapse of a specified time. (Since no holding current flows, power consumption will decrease.)

When the next movement command is received from the PLC, the servo will turn on and the actuator will start moving.

Refer to the above timing chart.

### Full servo control mode

The pulse motor is servo-controlled to reduce the holding current.

Although the exact degree of current reduction varies depending on the actuator model, load condition, etc., the holding current decreases to approx. 1/2 to 1/4.

Since the servo remains on, position deviation will not occur.

The actual holding current can be checked in the current monitor screen of the PC software.

- Push speed (No.34 PSHV)

This parameter defines the push speed to be applied after the actuator reaches the target position in push & hold operation.

Before the shipment, this parameter has been set to the default value selected in accordance with the characteristics of the actuator.

Set an appropriate speed in parameter No. 34 by considering the material and shape of the load, and so on.

Take note that maximum speed is limited to “20 [mm/sec]” even on high-speed types and that you should use the actuator at push speeds not exceeding this level.

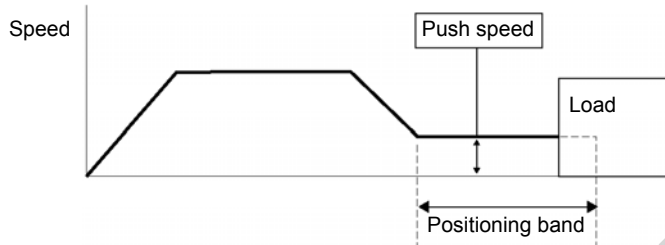

⚠ Caution: It is recommended that you set the push speed to 5 [mm/s] or above to minimize the negative effect of push force variation.

- Push completion judgment time (No.6 PSWT)

This parameter is used as a condition for determining that the load was contacted and the push & hold operation has completed.

As for the specific method of judgment, the push & hold operation is deemed to have completed if the current-limiting value set in the position table has been retained for the time set by parameter No. 6. Set an optimal time matching the current-limiting value, by considering the material and shape of the load, and so on.

The minimum setting unit is “1 [msec],” while the maximum value is “9999 [msec].” The factory setting is “255 [msec].”

(Note) The chart below explains how completion of push & hold operation is determined if the load shifted during the judgment and the current has changed as a result, based on a judgment time of 255 msec.

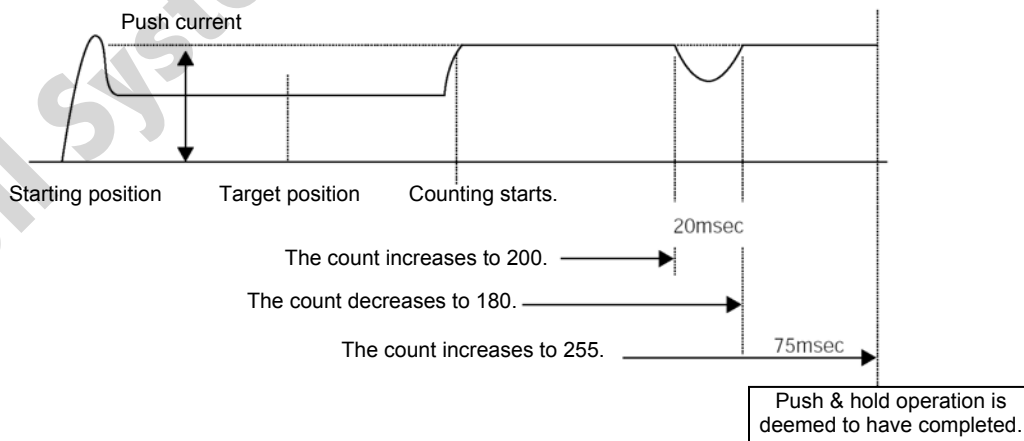

If the motor current remains at or above the push current for 200 msec and then drops below this level for 20 msec, the count will decrease by 20. When the push current is reached again thereafter, counting will start from 180. If the motor current remains at or above the push current for 75 msec, the count will increase to 255 and thus push & hold operation will be deemed to have completed.

In total, 295 msec was required for the judgment.

- Enable function (No.42 FDIO4)

Whether to enable or disable the deadman switch function on an ANSI-type teaching pendant is defined by parameter No. 42.

\* An ANSI-type teaching pendant will be developed in the future.

	Setting
Enable (Use)	0
Disable (Do not use)	1

The factory setting is "1 [Disable]."

- Polarity of home check sensor input (No.43 AIOF)

The home check sensor is not included in the standard specification, but it can be installed as an option. Normally this parameter need not be changed, but if the customer wishes to change the mode after the shipment, change the value of Parameter No. 43.

Definition of settings: 0 (Standard specification without home check sensor)

1 (Use the home check sensor based on contact-a sensor polarity)

2 (Use the home check sensor based on contact-b sensor polarity)

[Explanation of operation]

[1] When a home return command is issued, the actuator moves until contacting the mechanical end.

Upon contact with the mechanical end, the home check sensor signal is detected.

[2] Next, the actuator reverses its direction and stops at the home position.

[3] The controller determines that the movement has completed successfully if the home check sensor signal had changed when the actuator stopped. If the sensor signal remains the same, the controller recognizes that "position deviation" has occurred, in which case the controller will generate a "Home sensor not detected" error and output an alarm signal.

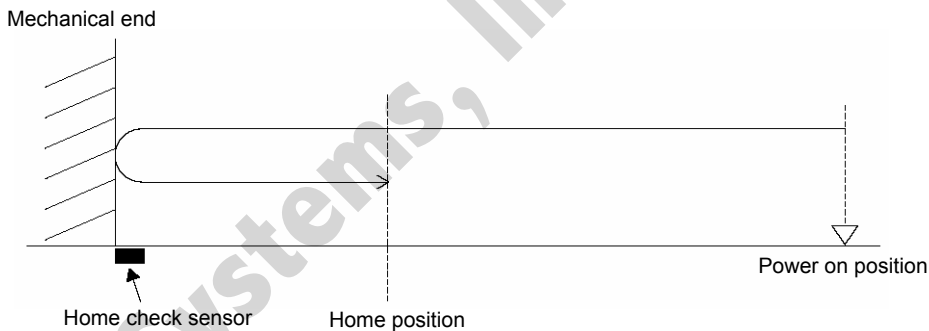

- Load output judgment time (No.50 LDWT)

If the torque check function is used in push & hold operation, the load output (LOAD signal) will turn ON when a specified condition is met. Since the command torque does not remain constant but fluctuates within a certain band while the actuator is moving, whether or not to turn ON the load output is determined based on whether the total duration of periods in which the command torque has exceeded the threshold corresponds at least to a specified time. This specified time is set using this parameter. The default value is "255 msec."

- Torque check range (No.51 TRQZ)

This parameter sets whether or not to use the check range when determining if the threshold has been exceeded. The default value is "0," i.e., to enable the check range.

	Setting
Enable (Use the check range to make judgment)	0
Disable (Do not use the check range to make judgment)	1

- Ball screw lead length (No.77 LEAD)

This parameter defines the ball screw lead length.

A default value appropriate for the characteristics of the actuator is set at the factory.

- Axis operation type (No.78 ATYP)

This parameter defines the type of the actuator used.

Definition of settings : 0 (Linear axis)  
: 1 (Rotational axis)

- Rotational axis mode selection (No.79 ATYP)

If the axis operation type (No. 78) is set to "rotational axis," selecting the index mode will fix the current value to a range of 0 to 359.99. If the index mode is selected, shortcut control can be used.

Definition of settings : 0 (Normal mode)  
: 1 (Index mode)

**Caution:** Push & hold operation cannot be performed in the index mode. If push action data is entered in the position data, the data will be disabled and the actuator will perform normal movement. The positioning band will correspond to the default positioning band set by the applicable parameter.

- Shortcut selection for rotational axis (No.80 ATYP)

Set this parameter if you want to rotate the rotational axis in a specific direction.

"Shortcut" refers to a type of operation in which the actuator moves to the next point by taking the shortest path.

	Setting
Disable	0
Enable	1

\* When shortcut is selected, the actuator can be rotated in a specific direction.

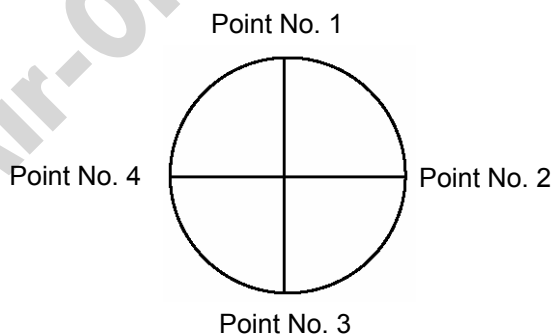

Positions

Point number	Position data
1	0
2	90
3	180
4	270

One degree of position data corresponds to 1 mm.

If the actuator is moved in the order to positions 1 → 2 → 3 → 4, the actuator will operate differently depending on whether or not shortcut is selected, as explained below.

When shortcut is not selected

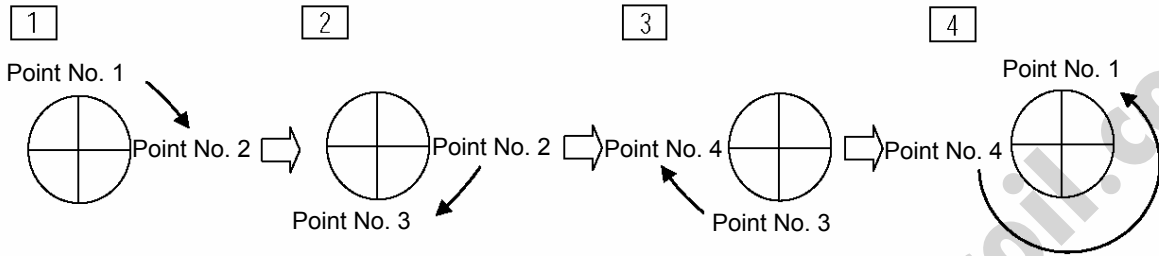

When shortcut is selected

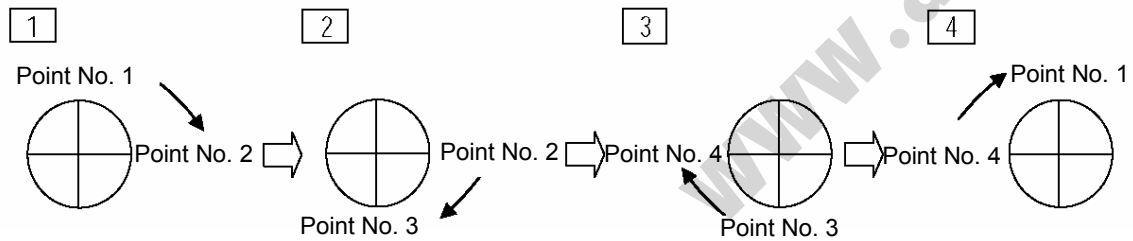

- Absolute unit (No.83 ETYP)

Parameter No. 83 sets whether or not an optional simple absolute unit is used.

	Setting
Not used	0
Used	1

## 8.2.3 Parameters Relating to the External Interface

- PIO pattern selection (No.25 IOPN)

Select the PIO operation pattern in parameter No. 25.

This setting forms the basis of operation, so be sure to set this parameter at the beginning.

The factory setting is "0 [Standard type]."

Parameter No. 25 setting	Feature of PIO pattern
0	Standard type A basic type supporting 64 positioning points and two zone outputs. * How to set zone boundaries within which to output a zone signal: Zone boundaries are set using parameter Nos. 1 and 2 for one zone output, and in the position table for another zone output.
1	Teaching type In this type, 64 positioning points and one zone output (boundaries are set in the position table) are supported. In addition to the normal positioning mode, the user can also select the teaching mode in which the actuator can be jogged via commands from a PLC and the current actuator position can be written to a specified position. (Note 1) Jog commands from a PLC are also accepted in the positioning mode. (Note 2) Positions can be rewritten by approximately 100,000 times.
2	256-point positioning type The number of positioning points is increased to 256, so only one zone output is available (boundaries are set in the position table).
3	512-point positioning type The number of positioning points is increased to 512, so no zone output is available.
4	7-point type The number of positioning points is limited to seven to offer separate direct command inputs and movement complete outputs for respective positions. PLC ladder sequence circuits can be designed easily.
5	3-point type Use of the controller as an air cylinder is assumed in this type. Movement complete output signals function differently in this type, compared to the 7-point type. Specifically, the signal functions not only to "indicate movement complete," but also to "detect a position" in the same manner as auto-switches of an air cylinder. Push & hold operation cannot be performed.

- Movement command type (No.27 FPIO)

When the PIO pattern is set to “7-point type,” define the operation condition of the movement command input (ST0 to ST6) in parameter No. 27.

The factory setting is “0 [Level mode].”

Description of the movement command input	Setting
Level mode: The actuator starts moving when the input signal turns ON. When the signal turns OFF during the movement, the actuator will decelerate to a stop and complete its operation.	0
Edge mode: The actuator starts moving when the rise edge of the input signal is detected. The actuator will not stop even when the signal turns OFF during the movement, until the target position is reached.	1

[Level mode]

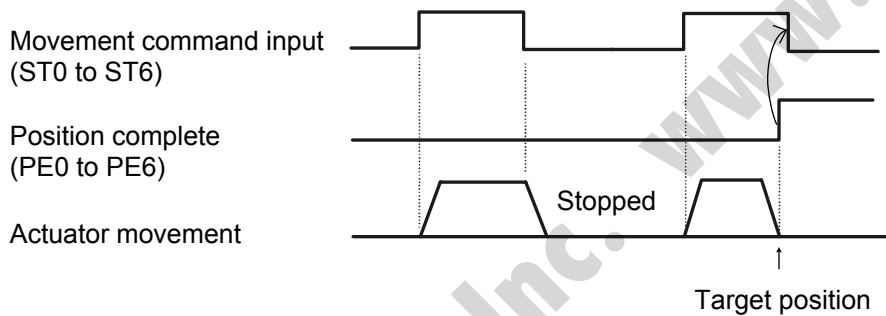

(Note) Turn OFF the movement command input after confirming that the target position has been reached.

[Edge mode]

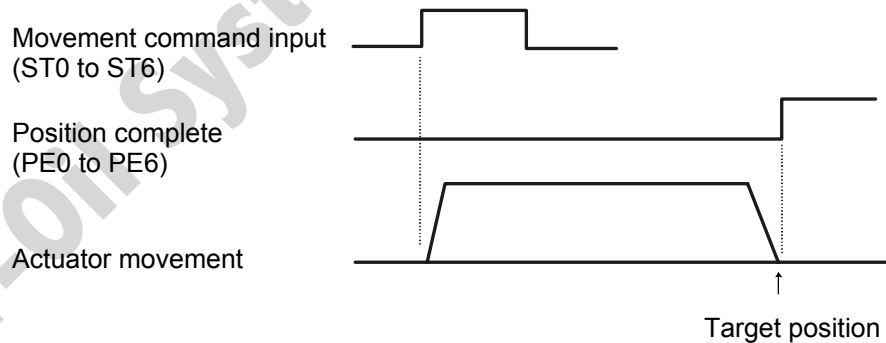

- Pause input disable selection (No.15 FPIO)

Parameter No. 15 defines whether the pause input signal is disabled or enabled.

	Setting
Enable (use)	0
Disable (do not use) the signal	1

The factory setting is "0 [Enable]."

- Servo ON input disable selection (No.21 FPIO)

Parameter No. 21 defines whether the servo ON input signal is disabled or enabled.

	Setting
Enable (use)	0
Disable (do not use)	1

The factory setting is "0 [Enable]."

- Home-return input disable selection (No.40 FPIO)

Parameter No. 40 defines whether the home-return input signal is disabled or enabled.

	Setting
Enable (use)	0
Disable (do not use)	1

The factory setting is "0 [Enable]."

- Operating-mode input disable selection (No.41 FPIO)

Parameter No. 41 defines whether the operating-mode input signal is disabled or enabled.

	Setting
Enable (use)	0
Disable (do not use)	1

The factory setting is "0 [Enable]."



- Output mode of position complete signal (No.39 FPIO)

This parameter is effective when any PIO pattern other than “5” [3-point type] is selected.

It defines the status of completed position number signals [PM1 to PM256], movement complete signals at respective positions [PE0 to PE6] and position complete signal [PEND] to be applied if the servo turns off or “position deviation” occurs while the actuator is standing still after completing positioning.

The following two conditions can be considered:

- [1] The position has deviated, due to external force and while the servo was on, beyond the value set in the “Positioning band” field of the position table.
- [2] The position has deviated, due to external force and while the servo was off, beyond the value set in the “Positioning band” field of the position table.

This parameter is provided to permit flexible specification of how the “position complete status” is monitored in accordance with the characteristics of the system or sequence circuit on the PLC side.

The ON/OFF status of each position complete signal is controlled as follows in accordance with the setting of parameter No. 39.

Setting of parameter No. 39	Definition of completed position number signals [PM1 to PM256], movement complete signals at respective positions [PE0 to PE6] and position complete signal [PEND]
0 [PEND]	[1] The servo is on The signal remains ON even after the current position has exited the range set by the “Positioning band” field of the position table, with respect to the target position. [2] The servo is off The signal is OFF unconditionally regardless of the current position.
1 [INP]	Regardless of the servo on/off status, the signal turns ON if the current position is within the range set by the “Positioning band” field of the position table, with respect to the target position, and turns OFF if the current position is outside this range. * In this mode, the applicable signals are used as limit switches.

The factory setting is “0 [PEND].”

- SIO communication speed (No.16 BRSL)

Set the communication speed to be used when the control is performed via serial communication using the PLC’s communication module.

Set an appropriate value in parameter No. 16 in accordance with the specification of the communication module.

One of 9600, 19200, 38400 and 115200 bps can be selected as the communication speed.

The factory setting is “38400 [bps].”

- Minimum delay time for slave transmitter activation (No.17 RTIM)

This parameter defines the minimum delay until the controller’s transmitter will be activated after completion of command reception, when serial communication is performed using the PLC’s communication module.

The factory setting is “5 [msec],” but other necessary delay time must be set in parameter No. 17 if the specification of the communication module exceeds 5 msec.

# P<sub>CON</sub>

---

---

- Silent interval multiplier (No.45 SIVM)

This parameter is not used for this controller. It is applied to controllers of RS485 serial communication type.

If specified, this parameter defines the multiplier to be applied to the silent interval time for delimiter judgment in the RTU mode.

The default setting is the communication time corresponding to 3.5 characters in accordance with the Modbus specification.

This setting need not be changed for normal operations performed with a PC or teaching pendant.

If the scan time of the PLC is not optimal and the character transmission interval exceeds the silent interval, the silent interval time can be extended using parameter No. 45.

The minimum setting unit is "1 [time]," while the input range is "0 to 10." If "0" is set, no multiplier is applied.

Air-Oil Systems, Inc. [www.airoil.com](http://www.airoil.com)

## 8.2.4 Servo Gain Adjustment

Before the shipment, the servo has been adjusted in accordance with the standard specification of the actuator. Accordingly, the servo settings need not be changed in normal conditions. Nonetheless, the parameters relating to servo adjustment are made accessible by the customer so that speedy actions can be taken in situations where vibration or noise occurs due to the affixing method of the actuator, load condition, or the like.

In particular, custom types (having a longer ball screw lead or stroke than standard types) are more vulnerable to vibration and noise due to external conditions.

In these circumstances, the following parameters must be changed. Contact IAI for details.

- Servo gain number (No.7 PLG0)

Parameter No.	Unit	Input range	Default
7	5 rad/sec	0 ~ 31	6

This parameter determines the response when a position control loop is used. Increasing the set value improves the tracking performance with respect to the position command. However, increasing the parameter value excessively increases the chances of overshooting. If the set value is small, the tracking performance with respect to the position command drops and positioning takes a longer time.

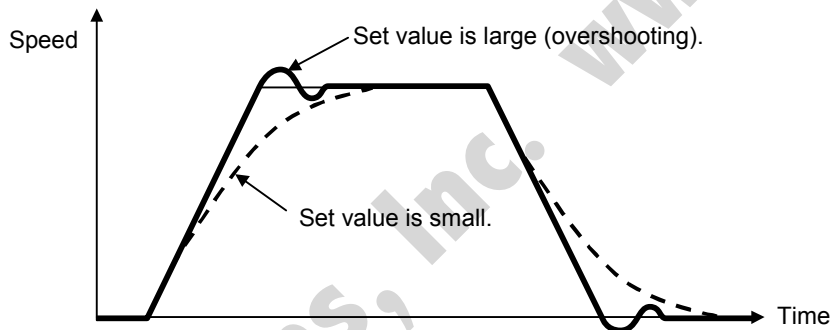

- Speed loop proportional gain (No.31 VLPG)

Parameter No.	Unit	Input range	Default
31	---	1 ~ 27661	Set individually in accordance with the actuator characteristics.

This parameter determines the response when a speed control loop is used. Increasing the set value improves the tracking performance with respect to the speed command (i.e., servo rigidity increases).

The greater the load inertia, the larger this parameter value should be.

However, increasing the parameter value excessively makes the actuator more vulnerable to overshooting or shaking, leading to mechanical vibration.

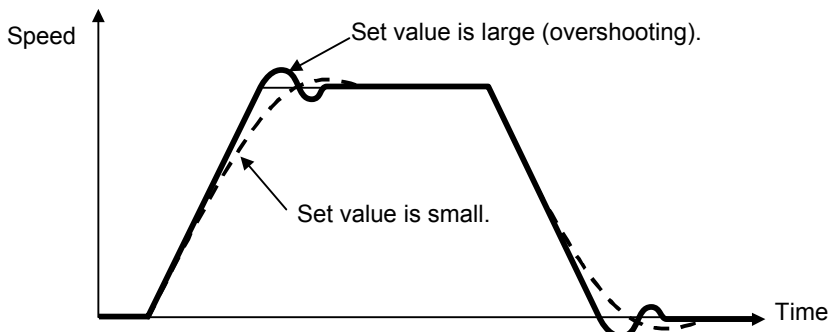

● Speed loop integral gain (No.32 VLPT)

Parameter No.	Unit	Input range	Default
32	---	1 ~ 217270	Set individually in accordance with the actuator characteristics.

This parameter determines the response when a speed control loop is used. Increasing the set value lowers the response with respect to the speed command, while also decreasing the reactive force that generates upon load change. Decreasing the parameter value excessively makes the actuator more vulnerable to overshooting or shaking, leading to mechanical vibration. If the set value is small, the tracking performance with respect to the position command drops and positioning takes a longer time.

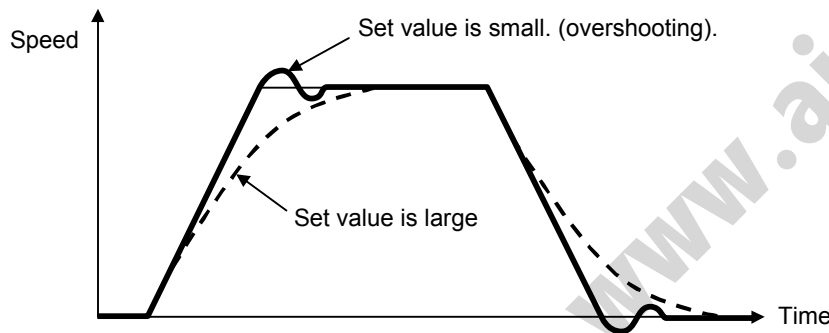

● Torque filter time constant (No.33 TRQF)

Parameter No.	Unit	Input range	Default
33	---	1 ~ 2500	Set individually in accordance with the actuator characteristics.

This parameter determines the filter time constant for torque commands. If the resonance frequency of the machine is smaller than the response frequency of the servo loop, the motor vibrates. This mechanical resonance can be suppressed by increasing the value set in this parameter. However, increasing the parameter value excessively may reduce the stability of control.

## 9. PC/Teaching Pendant Connection Method in Multi-axis Configurations

This section explains the method to permanently connect a PC/teaching pendant in configurations consisting of multiple axes, so that the PC/teaching pendant connector need not be removed/inserted each time.

The connector is connected to a SIO converter, and the SIO converter sends/receives data to/from each controller via RS485 serial communication.

The basic specifications are as follow:

- [1] Maximum number of connected axes: 16
- [2] Maximum length of serial communication cable: 100 m or less
- [3] Terminal resistor: 220  $\Omega$  (Be sure to install a terminal resistor for the last axis to prevent the effect of radiating noise.)

### 9.1 Connection Example

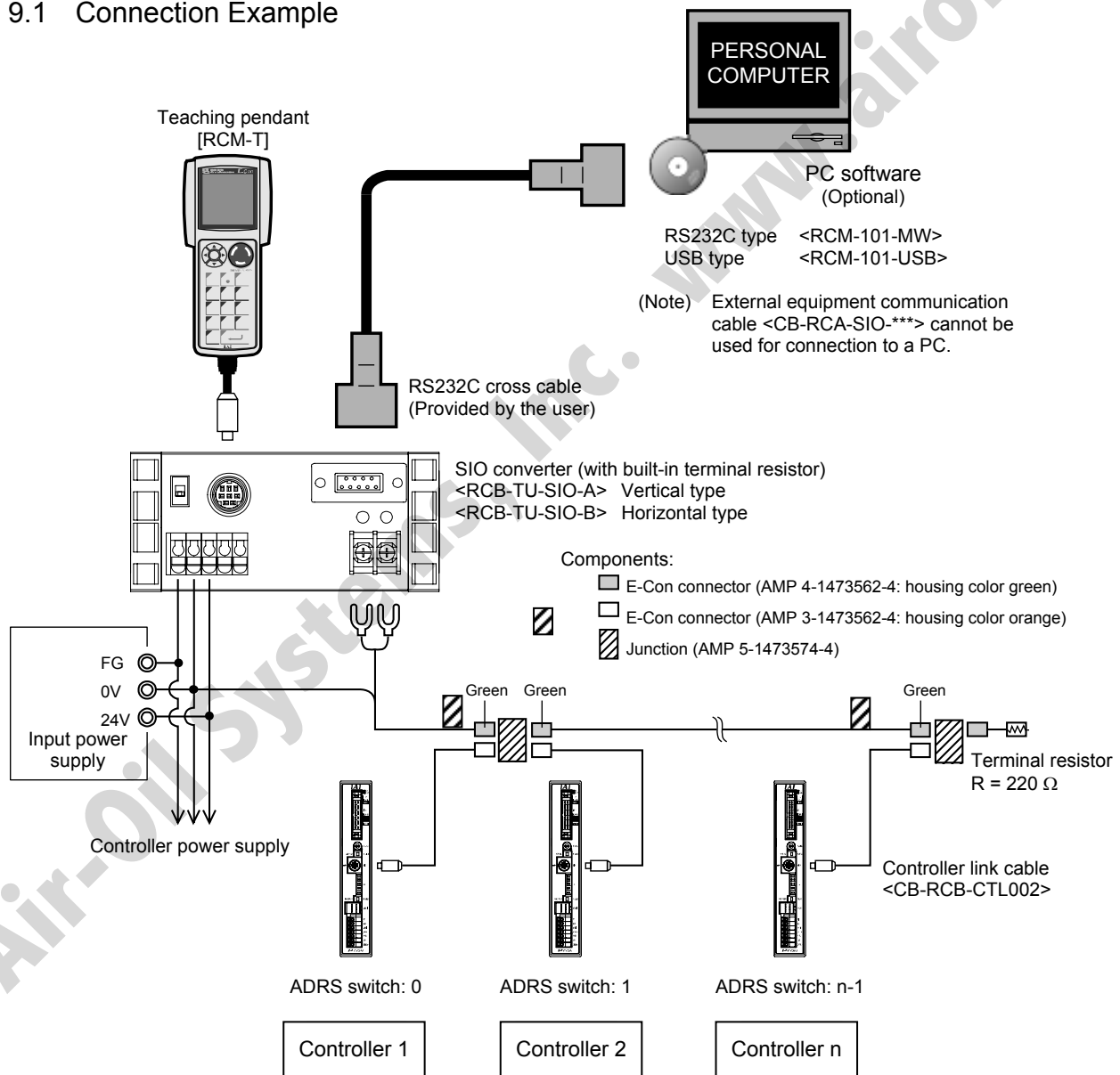

**Caution:** Do not connect the teaching pendant and PC at the same time.  
If both are connected at the same time, a communication error (message level) will occur.

## 9.2 Name and Function of Each Part of the SIO Converter

This is a converter unit conforming to RS485/232C.

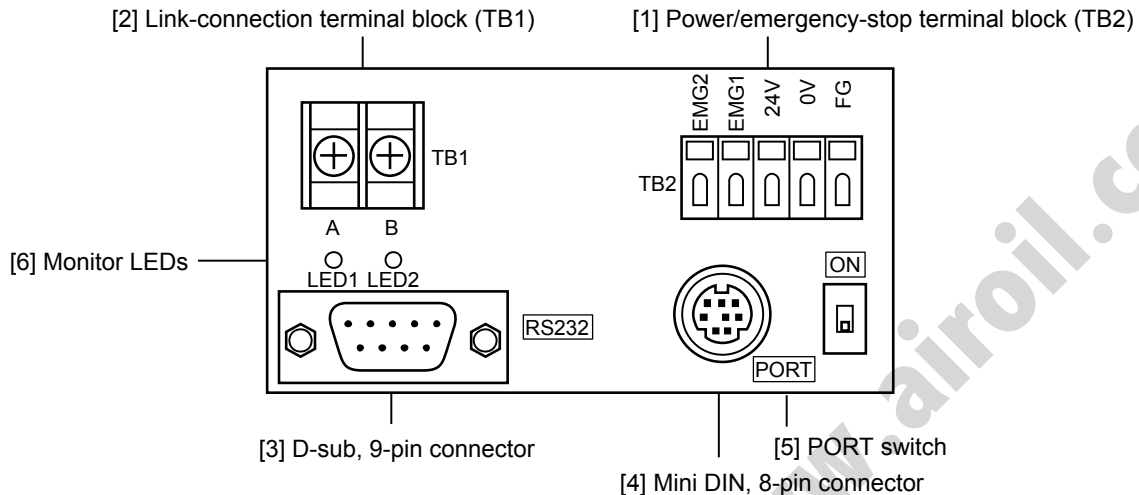

### [1] Power/emergency-stop terminal block (TB2)

EMG1, EMG2	Provide a contact output for the emergency-stop switch on the teaching pendant. EMG1 and EMG2 connect to the emergency-stop switch on the teaching pendant when the PORT switch is ON, or are shorted when the PORT switch is OFF. These terminals comprise an interlock with a safety circuit provided by the user.
24V	Positive side of the 24-V power supply (power supply for the teaching pendant and conversion circuit)
0V	Negative side of the 24-V power supply
FG	FG of the 24-V power supply

(Note) 0V connects to pin 7 (GND) in the controller's communication connector.

- Connection method  
Use a connection cable satisfying the following specifications:

Item	Specification
Applicable wire size	Single wire: $\varnothing 0.8$ to 1.2 mm / Stranded: AWG size 20 to 18 (end is soldered)
Stripped wire length	10 mm

Used for continuity check      Insert a flathead screwdriver with a bit size of approx. 2.6 mm.

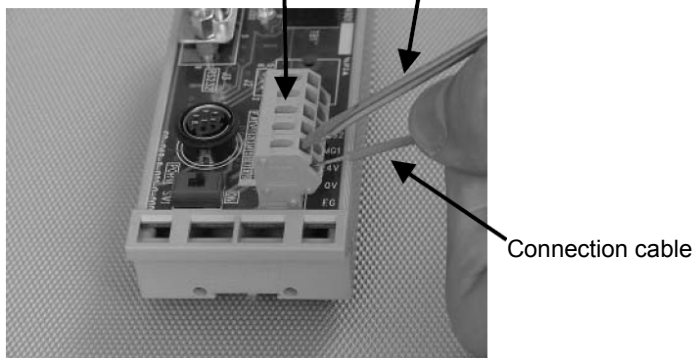

# P CON --- ---

- [2] Link-connection terminal block (TB1)  
A connection port for linking the controller.  
“A” on the left side connects to pin 1 (SGA) in the controller’s communication connector.  
“B” on the right side connects to pin 2 (SGB) in the controller’s communication connector.  
(Note) Be sure to use twisted pair wires for the above two connections (SGA/SGB).
- [3] D-sub, 9-pin connector  
A connection port with the PC.
- [4] Mini DIN, 8-pin connector  
A connection port with the teaching pendant.
- [5] PORT switch  
A switch for enabling/disabling the teaching pendant.  
Set the switch to ON when a teaching pendant is used, or OFF when teaching pendant is not used.
- [6] Monitor LEDs  
LED1 --- Lit when the controller is transmitting  
LED2 --- Lit when the RS232 is transmitting

Air-Oil Systems, Inc. www.airoil.com

## 9.3 Address Switch

Set an address (0 to 15) as a hexadecimal (0 to F) using the ADRS switch on the front panel of each controller to define the slave number for the controller.

Assign "0" to the controller nearest the host, and then assign 1, 2, 3, ..., E and F to the remaining controllers in the direction of moving away from the host.

After all addresses have been set, reconnect the power.

**Caution:** After the setting, be sure to confirm that the addresses are not duplicated.

Adjust the arrow to a desired position using a flathead screwdriver.

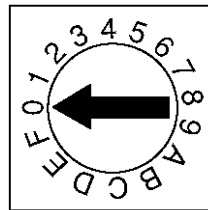

## 9.4 Connection Cables

- Controller link cable  
Model: CB-RCB-CTL002

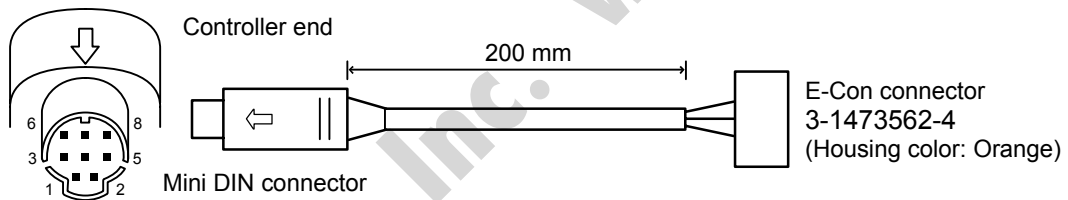

Signal	No.
SGA	1
SGB	2
+5V	3
EMB	4
EMGA	5
+24V	6
GND	7
EMGB	8

Yellow  
Orange

Blue

No.	Signal
1	SGA
2	SGB
3	GND
4	

(Reference) Connection diagram for RS232C cross cable

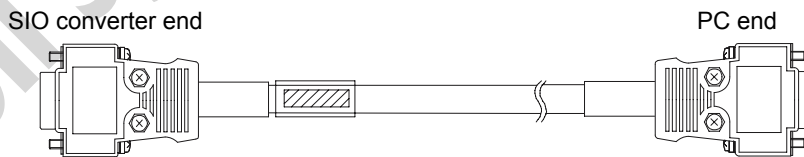

D-sub, 9-pin female connector

Signal	No.
	1
RD	2
SD	3
ER	4
SG	5
DR	6
RS	7
CS	8
	9

No.	Signal
1	
2	RXD
3	TXD
4	DTR
5	SG
6	DSR
7	RTS
8	CTS
9	

D-sub, 9-pin female connector



## 9.5 Detail Connection Diagram

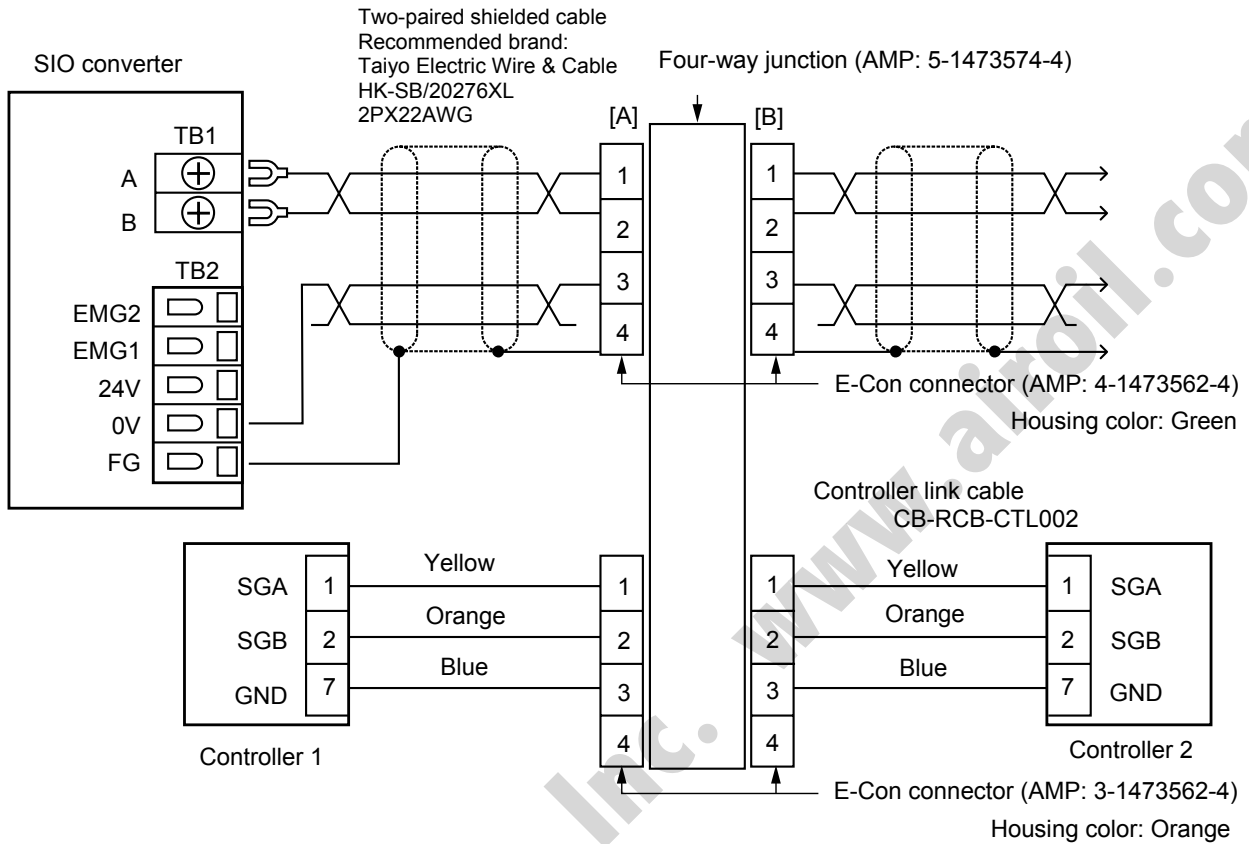

(Note) The user must provide the two-paired shielded cable.  
If cables other than the recommended brands are connected to [A] and [B], use those with a cable-sheath outer diameter of 1.35 to 1.60 mm.

### Accessories (Optional):

- [1] Controller link cable CB-RCB-CTL002 (connector on both ends), length 200 mm
- [2] Four-way junction, made by AMP: 5-1473574-4
- [3] E-Con connector, made by AMP: 4-1473562-4 (green)
- [4] Terminal resistor 220  $\Omega$  (with E-Con connector)

Of the above, [2], [3] and [4] are provided for the same number as the controller link cables. Therefore, not all units are needed when multiple axes are used.

## 10. Troubleshooting

### 10.1 Action to Be Taken upon Occurrence of Problem

Upon occurrence of a problem, take an appropriate action according to the procedure below in order to ensure speedy recovery and prevent recurrence of the problem.

- a. Check the status indicator lamps.
  - SV (green) --- The servo is ON.
  - ALM (red) --- An alarm is present, or an emergency stop has been actuated or the motor drive power is cut off.
- b. Check for error in the host controller.
- c. Check the voltage of the main 24-VDC power supply.
- d. Check the voltage of the 24-VDC power supply for I/O signals.
- e. Check for alarm.
  - Confirm the details of error on the PC or teaching pendant.
- f. Check the cables for connection error, disconnection or pinching.
  - Before performing a continuity check, turn off the power (to prevent a runaway actuator) and disconnect the cables (to prevent accidental power connection due to a sneak current path).
- g. Check the I/O signals.
- h. Check the noise elimination measures (grounding, installation of surge killer, etc.).
- i. Review the events leading to the occurrence of problem, as well as the operating condition at the time of occurrence.
- j. Check the serial numbers of the controller and actuator.
- k. Analyze the cause.
- l. Take action.

Please check items a through j before contacting IAI.

(Reference) Changes in status indicator lamps and \*ALM output signal in respective conditions

	Servo OFF	Servo ON	Emergency stop actuated	Motor drive power cut off
SV (lamp)	Unlit	Lit	Unlit	Unlit
ALM (lamp)	Unlit	Unlit	Lit	Lit
*ALM (signal)	ON	ON	ON	ON

(Note 2) The \*ALM output signal is a contact-b signal.

After the power is turned on, this signal remains ON while the controller is normal. It remains OFF while the power is cut off.

It cannot be used as a contact-b interlock when the power is cut off.

## 10.2 Alarm Level Classification

Alarms are classified into two levels based on the corresponding symptoms.

Alarm level	ALM lamp	*ALM signal	What happens when alarm generates	How to reset
Operation cancellation	Lit	Output	The actuator decelerates to a stop and then the servo turns OFF.	Input an alarm reset signal (RES) from the PLC. Reset by the PC/teaching pendant.
Cold start	Lit	Output	The actuator decelerates to a stop and then the servo turns OFF.	Reconnect the power.

(Note) The \*ALM output signal is a contact-b signal.  
 After the power is turned on, this signal will remain ON while the controller is normal, and turn OFF if an alarm occurs.  
 Although the \*ALM signal will turn OFF when the power is cut off, it cannot be used as a contact-b interlock.

- How to reset operation-cancellation level alarms  
 Input an alarm reset signal (RES) continuously for 6 msec or more.  
 This resets the \*ALM signal to ON, so turn OFF the RES signal after confirming that the \*ALM signal is ON.

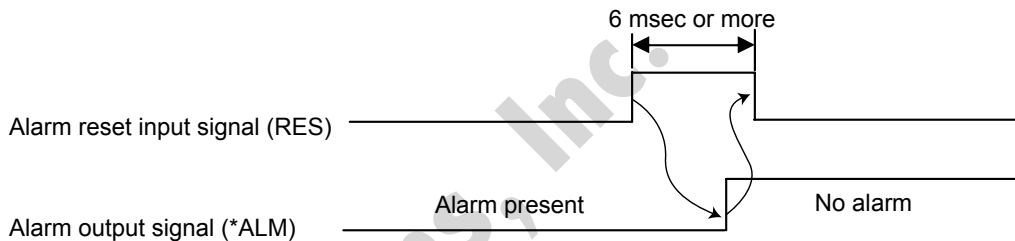

**⚠ Caution:** Reset each alarm after identifying and removing the cause of the alarm. If the cause of the alarm cannot be removed or the alarm still persists after the cause has been removed, contact IAI.  
 If the same error occurs again after resetting the alarm, it means that the cause of the alarm still remains.

## 10.3 Alarm Description Output Using PIO

In PIO patterns 0 to 3 (64 to 512-point positioning type), alarm information can be output using the ports for completed position output signals (four bits of PM1 to PM8) so that when an alarm occurs, the nature of the alarm can be identified on the PLC side.

Program the PLC so that whether a given output is a completed position number or alarm can be identified based on the status of the alarm output signal (\*ALM).

Bit assignment table for alarm description (● = OFF, ○ = ON)

*ALM	PM8	PM4	PM2	PM1	Description: Code number in ( )
○	x	x	x	x	Normal
●	●	●	○	●	PWRT signal detected during movement (092) PWRT signal detected before completion of home return (093)
●	●	●	○	○	Deceleration command error (0A7)
●	●	○	●	●	Unmatched PCB (0F4)
●	●	○	○	●	Parameter data error (0A1) Position data error (0A2)
●	●	○	○	○	Excitation detection error (0B8) Home sensor not detected (0BA) Home return timeout (0BE)
●	○	●	●	●	Excessive actual speed (0C0)
●	○	●	●	○	Motor power-supply overvoltage (0C9) Overheating (0CA) Control power-supply overvoltage (0CC) Control power-supply voltage low (0CE)
●	○	●	○	○	Deviation overflow (0D8) Out of push & hold operation range error (0DC) Software stroke limit overtravel error (0D9)
●	○	○	●	●	Servo error (0C1)
●	○	○	●	○	Relating to encoder disconnection Phase-A/B disconnection detection (0E8) Phase-A disconnection detection (0E9) Phase-B disconnection detection (0EA)
●	○	○	○	●	CPU error (0FA)
●	○	○	○	○	Nonvolatile memory write verification error (0F5) Nonvolatile memory write timeout (0F6) Damaged nonvolatile memory (0F8)

## 10.4 Alarm Description and Cause/Action

### (1) Message level alarms

Code	Error name	Cause/Action
092	PWRT signal detected during movement	<p>Cause: The current-position write signal (PWRT) was input in the teaching mode while the actuator was jogging.</p> <p>Action: Input the PWRT signal after confirming that the jog button is not pressed and the actuator is stopped (MOVE output signal is OFF).</p>
093	PWRT signal detected before completion of home return	<p>Cause: The current-position write signal (PWRT) was input in the teaching mode when home return was not yet completed.</p> <p>Action: Input the HOME signal first to perform home return, and then input the PWRT signal after confirming that home return has completed (HEND output signal is ON).</p>
0A1	Parameter data error	<p>Cause: The input range of parameter range data is not appropriate. (Example) This error occurs when the magnitude relationship of a pair of range parameters is inappropriate, such as when the value of soft limit- is mistakenly set to 300 mm when the value of soft limit+ is 200.3 mm.</p> <p>Action: Change the parameters to appropriate values.</p>
0A2	Position data error	<p>Cause: [1] A move command was input when no target position was set in the "Position" field. [2] The target position in the "Position" field exceeds a soft limit setting. [3] An incremental target position was specified in the "Position" field in the 3-point type.</p> <p>Action: [1] Set a target position first. [2] Change the target position to a value inside the soft limit setting. [3] Specify an absolute target position.</p>
0A7	Deceleration command error	<p>If a position command is issued while the actuator is moving where the target position corresponding to the position number is located near a soft limit and the deceleration is also set low, the actuator may move past the soft limit.</p> <div style="text-align: center;"> <p>The diagram shows a velocity profile with a trapezoidal shape. A dashed line represents a deceleration path that starts at a position too close to the soft limit. A vertical dashed line marks the 'Soft limit' position. A box above the dashed line says 'Deceleration starting position not resulting in soft limit overshoot'. Another box points to the end of the dashed line, saying 'If a command is issued here, soft limit overshoot will occur.'</p> </div> <p>Cause: When the speed was changed during movement, the next move command was not issued quick enough.</p> <p>Action: Quicken the speed change timing so that the actuator will not overshoot the soft limit.</p>

Code	Error name	Cause/Action
0B6	Phase-Z detection timeout	<p><b>Cause</b> Phase Z could not be detected within the phase-Z output status detection time set in the simple absolute unit.</p> <p>[1] When the detail code is H'0001 A timeout occurred during the pole sensing operation performed in conjunction with magnetic pole check operation.</p> <p>[2] When the detail code is H'0002 A timeout occurred while the actuator was operating after reversing its direction upon contacting the load in a home return.</p> <p><b>Action</b></p> <ul style="list-style-type: none"> <li>• Check the wiring condition of the motor relay cable.</li> <li>• Check the wiring condition of the brake cable, and also turn on/off the brake release switch and check if the brake makes “click” sounds.</li> <li>• Check the assembly condition of mechanical parts for any abnormality.</li> <li>• Move the actuator away from the mechanical ends, and then reconnect the power.</li> <li>• If the payload is normal, turn off the power and move the actuator by hand to check the slide resistance.</li> </ul>
0BA	Home sensor not detected	<p>This error indicates that the actuator equipped with the home check sensor has not yet successfully completed the home return operation.</p> <p><b>Cause:</b> [1] The load contacted any surrounding equipment or structure during home return. [2] The slide resistance of the actuator is high in some location. [3] The home check sensor is not properly installed, faulty or open.</p> <p><b>Action:</b> If the load is not contacting any surrounding equipment or structure, [2] or [3] is suspected. Please contact IAI.</p>
0BE	Home return timeout	<p><b>Cause:</b> Home return does not complete after elapse of the time set by the applicable manufacturer's parameter following the start of home return operation. (This error does not occur in normal operations.)</p> <p><b>Action:</b> The controller and actuator combination is wrong, among others. Please contact IAI.</p>
0C0	Excessive actual speed	<p><b>Cause:</b> The motor speed exceeded the maximum level set by the applicable manufacturer's parameter. Although this error does not occur in normal operations, it may occur if the load decreased before a servo error was detected and the actuator moved quickly as a result, which can be caused by various reasons including the following: [1] The slide resistance of the actuator is high in some location. [2] The load increased due to momentary application of external force.</p> <p><b>Action:</b> Check the assembly condition of mechanical parts for any abnormality. If the actuator itself is suspected as the cause, please contact IAI.</p>
0C1	Servo error	<p>This error indicates that the motor could not be operated for 2 seconds or more after the move command was accepted and before the target position was reached.</p> <p><b>Cause:</b> [1] The motor relay cable connector is loose or open. [2] If the actuator is equipped with a brake, the brake cannot be released. [3] The load increased due to application of external force. [4] The slide resistance of the actuator itself is high.</p> <p><b>Action:</b> [1] Check the wiring condition of the motor relay cable.</p>

Code	Error name	Cause/Action
		<p>[2] Check the wiring condition of the brake cable. Also, turn on/off the brake release switch and check if the brake makes “click” sounds.</p> <p>[3] Check the assembly condition of mechanical parts for any abnormality.</p> <p>[4] If the payload is normal, turn off the power and move the actuator by hand to check the slide resistance.</p> <p>If the actuator itself is suspected as the cause, please contact IAI.</p>
0C9	Motor power-supply overvoltage	<p>This error indicates that the motor power-supply voltage is excessively high (24 V + 20%: 28.8 V or above).</p> <p>Cause: [1] The 24-V input power-supply voltage is high. [2] A faulty part inside the controller.</p> <p>Action: Check the input power-supply voltage. If the voltage is normal, please contact IAI.</p>
0CA	Overheating	<p>This error indicates that the temperature around the power transistor in the controller is excessively high (95°C or above).</p> <p>Cause: [1] The ambient temperature is high. [2] A faulty part inside the controller.</p> <p>Action: [1] Lower the ambient temperature. If [1] does not apply, please contact IAI.</p>
0CC	Control power-supply overvoltage	<p>This error indicates that the 24-V input power-supply voltage is excessively high (24 V + 20%: 28.8 V or above).</p> <p>Cause: [1] The 24-V input power-supply voltage is high. [2] A faulty part inside the controller.</p> <p>Action: Check the input power-supply voltage. If the voltage is normal, please contact IAI.</p>
0CE	Control power-supply voltage low	<p>This error indicates that the 24-V input power-supply voltage is low (24 V - 20%: 19.2 V or below).</p> <p>Cause: [1] The 24-V input power-supply voltage is low. [2] A faulty part inside the controller.</p> <p>Action: Check the input power-supply voltage. If the voltage is normal, please contact IAI.</p>
0D8	Deviation overflow	<p>The position deviation counter has overflowed.</p> <p>Cause: [1] The speed dropped during movement due to the effect of an external force, etc. [2] The pole sense detection operation after power on is unstable.</p> <p>Action: [1] Check the load conditions—such as whether the load is contacting a surrounding object or the brake is disengaged—and then correct the abnormality, if any [2] An overload condition is suspected, so review the load weight.</p>
0D9	Software stroke limit overtravel error	<p>Cause: [1] The actuator installed vertically overshoot and exceeded a software stroke limit due to a large load or high deceleration setting when the target position was set to a point near the software stroke limit. [2] The actuator was moved to outside the software stroke limits with the servo turned off, and then the servo was turned on.</p> <p>Action: [1] Set the deceleration curve properly so that the actuator will not overshoot when stopping. [2] Return the actuator to inside the software stroke limits, and then turn on the servo.</p>

Code	Error name	Cause/Action
0DC	Out of push & hold operation range error	This error occurs when the actuator was pushed back to the target position due to an excessive push force after completion of push & hold operation. Review the entire system.
0F5	Nonvolatile memory write verification error	When data has been written to the nonvolatile memory, the written data is read again to check (verify) if it matches the original data. This error indicates that the two data do not match. Cause: [1] Faulty nonvolatile memory [2] The memory has been rewritten more than 100,000 times. (The nominal rewrite limit of the nonvolatile memory is around 100,000 times.) Action: If the alarm generates again after reconnecting the power, please contact IAI.
0F6	Nonvolatile memory write timeout	This error indicates that response is not received within the specified time after data was written to the nonvolatile memory. Cause: [1] Faulty nonvolatile memory [2] The memory has been rewritten more than 100,000 times. (The nominal rewrite limit of the nonvolatile memory is around 100,000 times.) Action: If the alarm generates again after reconnecting the power, please contact IAI.



## (2) Cold-start level alarms

Code	Error name	Cause/Action
0B8	Pole sense error	<p>This controller performs excited-phase detection when the servo is turned on for the first time after the power on. This error indicates that the specified encoder signal level could not be detected after excitation for the time set by parameter No. 29 (Excited-phase signal detection time).</p> <p>Cause: [1] Loose or disconnected motor-relay cable connector            [2] Brake cannot be released on a controller equipped with brake.            [3] Large motor load due to application of external force            [4] Power was input when the actuator was contacting a mechanical end.            [5] Large slide resistance of the actuator itself</p> <p>Action: [1] Check the wiring condition of the motor relay cable.            [2] Check the wiring condition of the brake cable, and also turn on/off the brake release switch to see if the brake makes "click" sounds.            [3] Check for abnormality in the assembly condition of mechanical parts.            [4] Move the actuator away from the mechanical end and then reconnect the power.            [5] If the load is normal, cut off the power and move the actuator by hand to check the slide resistance.</p> <p>If the actuator is suspected to be the cause, please contact IAI.</p>
0E5	Encoder reception error	<p>Cause:</p> <p>[1] The controller was powered up before the simple absolute unit when the 24-V power supply was turned on.            [2] When the detail code is H'0001            The controller cannot communicate with the simple absolute unit properly due to noise, etc.            [3] When the detail code is H'0002            The controller cannot communicate with the simple absolute unit properly due to encoder cable disconnection, etc.</p> <p>Action:</p> <p>[1] Make sure the simple absolute unit is powered up before the controller (or at least the two are powered up simultaneously).            [2] Change the installation location of the controller. Provide noise elimination measures such as setting a frame ground, noise filter or clamp filter.            [3] Check the encoder relay cable connecting the controller and simple absolute unit to see if the connectors are loose. Or, replace the cable.</p>
0E8	Phase-A/B disconnection detection	<p>Encoder signals cannot be detected correctly.</p> <p>Cause:</p> <p>[1] Loose or disconnected encoder-relay cable connector            [2] Piano switch 4 on the simple absolute unit is not set correctly.            [3] If a RA10C actuator is used together with an actuator or actuators of other type, the encoder cables may not be connected in the correct combination.</p> <p>Action:</p> <p>[1] Check for loose or disconnected connector.            [2] Check if the settings conform to 5.1.1, "Piano Switch Settings" in the operation manual for the simple absolute unit.</p>
0E9	Phase-A disconnection detection	
0EA	Phase-B disconnection detection	

Code	Error name	Cause/Action
		<p>[3] Check the model name of the encoder cable.            (Encoder cable connecting the simple absolute unit and actuator)            Note) This action is applicable only to RCP2 series controllers.            Cable for RA10C type: CB-RFA-*            Other actuators: CB-RCP2-*</p>
0ED	Absolute encoder error (1)	<p>Cause:            [1] When the power was reconnected after completion of an absolute reset, the current position changed due to an external factor or for other reason while the absolute unit was communicating with the controller.            [2] When an absolute reset was performed, the current position changed due to an external factor or for other reason while the simple absolute unit was communicating with the controller.</p> <p>Action:            [1] When the detail code is H'0001            Turn off the power, make sure the actuator is not receiving vibration, etc., and then turn the power back on.            [2] When the detail code is H'0002            Make sure the actuator is not receiving vibration, etc., and then perform a home return operation again.</p>
0EE	Absolute encoder error (2)	<p>Cause:            [1] The power was turned on for the first time after connecting the battery to the simple absolute unit.            [2] When the detail code is H'0001            The battery voltage dropped to a level at which the encoder counter in the simple absolute unit could no longer retain the count.            [3] When the detail code is H'0002            The encoder connector was unplugged during a power outage, or the encoder cable was disconnected.            [4] When the detail code is H'0003            A parameter was changed.</p> <p>Action:            If [1], [2] or [4] is suspected as the cause, perform an absolute reset by referring to the operation manual for the simple absolute unit (5.2, "Absolute Reset Method").            [2] Supply power for at least 48 hours to charge the battery fully, and then perform an absolute reset.</p>
0EF	Absolute encoder error (3)	<p>Cause:            The current value changed at a speed equal to or greater than the specified rotational speed due to an external factor or for other reason while the power was cut off.</p> <p>Action:            Change the speed setting in the simple absolute unit and also implement measures to prevent the actuator from moving at a speed equal to or above the specified setting while the power is cut off.            If the battery backup time is more than sufficient, try setting a higher motor speed.            See also: 5.1.1, "Piano Switch Settings" in the operation manual for the simple absolute unit.            If this error occurred, perform an absolute reset by following the specified procedure (5.2, "Absolute Reset Method").</p>

# P CON

Code	Error name	Cause/Action
0F4	Unmatched PCB	<p>This controller uses a different motor drive circuit depending on the motor capacity, and thus adopts a different printed circuit board (PCB) appropriate for each motor capacity.</p> <p>For this reason, whether the motor type set by the applicable manufacturer's parameter matches the board is checked in the initialization process after startup.</p> <p>This error indicates that the two do not match.</p> <p>Cause: The parameter was not entered correctly or the correct board was not assembled.</p> <p>Action: Should this error occur, please contact IAI.</p>
0F8	Damaged nonvolatile memory	<p>Abnormal data was detected during the nonvolatile memory check after starting.</p> <p>Cause: [1] Faulty nonvolatile memory [2] The memory has been rewritten more than 100,000 times. (The nominal rewrite limit of the nonvolatile memory is around 100,000 times.)</p> <p>Action: If the alarm generates again after reconnecting the power, please contact IAI.</p>
0FA	CPU error	<p>The CPU is not operating properly.</p> <p>Cause: [1] Faulty CPU [2] Malfunction due to noise</p> <p>Action: If the alarm generates again after reconnecting the power, please contact IAI.</p>

## 10.5 Messages Displayed during Operation Using the Teaching Pendant

This section explains the warning messages that may be displayed during operation using the teaching pendant.

Code	Message name	Description
112	Invalid data	An inappropriate value was entered in a parameter. (Example) 9601 was entered as the serial communication speed by mistake. Enter an appropriate value again.
113 114	Value too small Value too large	The entered value is smaller than the setting range. The entered value is larger than the setting range. Refer to the actuator specifications or parameter table and enter an appropriate value again.
115	Home return non-completion	The current position was written when home return was not yet completed. Execute home return again.
117	No movement data	Target position is not set under the selected position number. Enter the target position first.
11E	Paired data mismatch	The values indicating the magnitude relationship of a pair of data are inappropriate. (Example) The same value was entered in both the parameters for + and – soft limits. Enter appropriate values again.
11F	Absolute position too small	The minimum movement toward the target position is determined by the lead length of the drive system and resolution of the encoder. This message indicates that the entered target value is smaller than the minimum movement. (Example) If the lead length is 20 mm, the encoder's resolution is 800 pulses and accordingly the minimum movement becomes $20 \div 800 = 0.025$ mm/pulse. In this case, this message will be displayed if 0.02 mm is entered as the target position.
121	Push & hold search end over	The final position in push & hold operation exceeds the soft limit. This has no negative effect if the actuator contacts the load. If the actuator misses the load, however, the soft limit will be reached and thus this message is displayed as a warning. Change either the target position or positioning band.
122	Multiple axes connected at assignment	Address was assigned when multiple axes were connected. Assign each address only when one axis is connected.
133	Address change prohibited	Address numbers are set using the rotary switches on the front panel. They cannot be set using the teaching pendant.

Code	Message name	Description
180	Address change OK	These messages are displayed to confirm operation. (They don't indicate an operation error or other abnormality.)
181	Controller initialization OK	
182	Home change all clear	
183	I/O function changed	
202	Emergency stop	This message indicates that an emergency stop has been actuated.
203	Motor voltage low	This message indicates that the motor drive power is cut off on the CG type. (Note) If the MPI and MPO terminals are closed, the controller may be faulty.
20A	Servo OFF during operation	This message indicates that the servo ON signal (SON) was turned OFF by the PLC while the actuator was moving, and that the servo turned OFF and the movement was disabled as a result.
20C	CSTR-ON during operation	This message indicates that a movement command signal was turned ON by the PLC while the actuator was moving, and that duplicate movement commands occurred as a result.
20D	STP-OFF during operation	This message indicates that the pause signal (*STP) was turned OFF by the PLC while the actuator was moving, and that the movement was disabled as a result.
20E	Soft limit over	This message indicates that a soft limit was reached.
210	HOME-ON during operation	This message indicates that the home return signal (HOME) was turned ON by the PLC while the actuator was moving, and that duplicate movement commands occurred as a result.
211	JOG-ON during operation	This message indicates that the jog signal (JOG) was turned ON by the PLC while the actuator was moving, and that duplicate movement commands occurred as a result.
220	Write prohibited during AUTO	This message indicates that an attempt was made to write position table data or parameter in the AUTO mode.
222	Operation prohibited during AUTO	This message indicates that an attempt was made to move the actuator in the AUTO mode.
301	Overrun error (M)	These messages indicate an error in the serial communication with the controller. Cause: [1] Garbage data due to the effect of noise [2] Duplicate slave numbers when multiple controllers are controlled by serial communication Action: [1] Adjust the wiring in a manner eliminating the effect of noise and review the installation of equipment, etc. [2] Change the slave numbers to avoid duplication. If the message is still displayed after taking the above actions, please contact IAI.
302	Framing error (M)	
304	SCIR-QUE OV (M)	
305	SCIS-QUE OV (M)	
306	R-BF OV	
308	Response timeout (M)	
30A	Packet R-QUE OV	
30B	Packet S-QUE OV	
307	Memory command refused	This message indicates that the command was refused in the serial communication with the controller.
309	Write address error	This message indicates that an indeterminate WRITE address error occurred in the serial communication with the controller. These conditions do not occur in normal operation. Should they occur, record the entire error list before cutting off the power for use in the cause investigation. Also contact IAI.

# P CON

Code	Message name	Description
30C	No connected axis	<p>This message indicates that no controller address is recognized.</p> <p>Cause:</p> <ul style="list-style-type: none"><li>[1] The controller is not operating properly.</li><li>[2] Only the supplied communication cable (SGA/SGB) is disconnected.</li><li>[3] If a SIO converter is used, 24V is supplied to the converter but the link cable is not connected.</li><li>[4] The ADRS switch settings are duplicated by mistake when multiple controllers are linked.</li></ul> <p>Action:</p> <ul style="list-style-type: none"><li>[1] Check if the RDY lamp on the controller is lit. If the lamp is not lit, the controller is faulty.</li><li>[2] If a spare teaching pendant is available, replace the current pendant with the spare unit, or with a PC, and see if the message disappears.</li><li>[3] Supply power after connecting the link cable between the converter and controller.</li><li>[4] Make sure the ADRS switch settings are not duplicated.</li></ul> <p>If the message is still displayed after taking the above actions, please contact IAI.</p>

## 10.6 Specific Problems

- I/O signals cannot be exchanged with the PLC.

Cause: [1] The 24-V I/O power supply is connected in reverse.

[2] If the problem is with an output circuit, a circuit component may have been damaged due to a large load that caused the current flowing into the circuit to exceed the maximum current.

[3] Contact failure in the connector or relay terminal block on the PLC end.

[4] Contact failure between the female pins in the flat cable connector and the male pins on the controller due to expanded female pins.

Action: Check the connection condition of the power supply and connector, as well as the load on the output side.

If the cause is identified as [1] or [2], the controller must be replaced. If there is a possibility of [4], the flat cable must be replaced. Please contact IAI.

**Warning:** When performing a continuity check of the flat cable, pay due attention not to expand the female pins in the connector. It may cause contact failure and disable normal operation of the controller.

- The ALM lamp illuminates when the power is input.

(An alarm is present, or an emergency stop has been actuated or the motor power cut off.)

\* If the ALM output signal is OFF, an alarm is present. Connect a PC or teaching pendant to check the nature of the error and then remove the cause.

\* If the ALM output signal is ON, the emergency stop circuit has been actuated. Check the following points, among others:

[1] Is the emergency-stop switch on the operation panel pressed or any necessary interlock released?

[2] Is the emergency-stop switch on the teaching pendant pressed?

[3] Is parameter No. 42 (Enable function) enabled by mistake by connecting a teaching pendant not supporting the enable switch?

[4] If multiple controllers are connected, is the crossover wiring correct?

- The SV lamp does not illuminate when the servo ON signal is input after the power was input.

(The servo does not turn ON.)

Cause: [1] Contact failure of the flat cable

[2] Faulty controller

Check the servo ON signal (SON) on the I/O monitor screen of the PC or teaching pendant.

If the signal is input, probably the controller is faulty. Please contact IAI.

- Home return ends in the middle in a vertical application.
  - Cause: [1] The load exceeds the rating.
    - [2] The ball screw is receiving torsional stress due to the affixing method of the actuator, tightening of bolts only on one side, etc.
    - [3] The slide resistance of the actuator itself is large.
  - Action: [1] Increase the value set in parameter No. 13 (Current-limiting value during home return). Increasing the parameter value will increase the home return torque. As a guide, however, remember that the maximum limit is 100% for the RA3C/RGD3C types and 75% for all other types.
    - [2] Loosen the fixing bolts and check if the slider moves smoothly. If the slider moves smoothly, review the affixing method and bolt tightening condition.
    - [3] If the slide resistance of the actuator itself is large, please contact IAI.
- Noise occurs during downward movements in a vertical application.
  - Cause: The load exceeds the rating.
  - Action: [1] Decrease the speed.
    - [2] Decrease the value set in the parameter No. 7 (Servo gain number). Do not decrease the parameter setting below "3."
- Vibration occurs when the actuator is stopped.
  - Cause: The slider is receiving an external force.
  - Action: If the external force cannot be removed, increase the value set in parameter No. 12 (Current-limiting value at standstill during positioning). Increasing this value will cause the holding torque at standstill to increase, so do not increase the parameter setting above 70%.
- The actuator overshoots when decelerated to a stop.
  - Cause: The load inertia is high due to an inappropriate balance of load and deceleration.
  - Action: Decrease the acceleration/deceleration setting.
- The home and target positions sometimes shift.
  - Cause: [1] The encoder waveform is disturbed by the effect of noise.
    - [2] In the case of a rod-type actuator, the non-rotation accuracy increased due to application of rotating moment to the rod.
  - Action: [1] Check if the grounding is implemented correctly. Also check for any equipment being a potential noise source.
    - [2] The actuator may have to be replaced in some cases. Please contact IAI.
- The speed is slow during push & hold operation.
  - Cause: The set current-limiting value is low with respect to the load and slide resistance.
  - Action: Increase the current-limiting value for push & hold operation.
- The actuator moves only a half of, or twice as much as, the specified movement.
  - Cause: [1] The combination of controller and actuator is wrong.
    - The lead length of the ball screw varies depending on the actuator type, so a wrong combination will cause the movement and speed to change.
    - [2] Factory setting error at IAI
  - Action: [1] If multiple actuators of different types must be used, confirm using the identification labels, etc., that the correct actuator is connected to the controller.
    - [2] Please contact IAI.



- A servo error occurred while the actuator was moving (ROBO Gripper).  
Cause: The load was not positioned properly and contacted the finger attachment in the positioning mode.  
Action: Adjust the starting position of push action and the thickness of finger attachment (including buffer material) by considering a possible offset of load position, so that the load can be clamped properly in the push & hold mode.  
Immediately after recovery from the error, the feed mechanism may still be locked. Be sure to turn the open/close screw to loosen each finger attachment before resetting the alarm.

⚠ Caution: If the servo ON signal is disabled or the alarm is reset while the servo ON signal is still ON, the servo will remain ON.  
If the open/close screw is turned in this condition, the screw will return automatically and the lock cannot be released. Therefore, reissuing a movement command will cause the alarm to generate again.

[2-finger type]

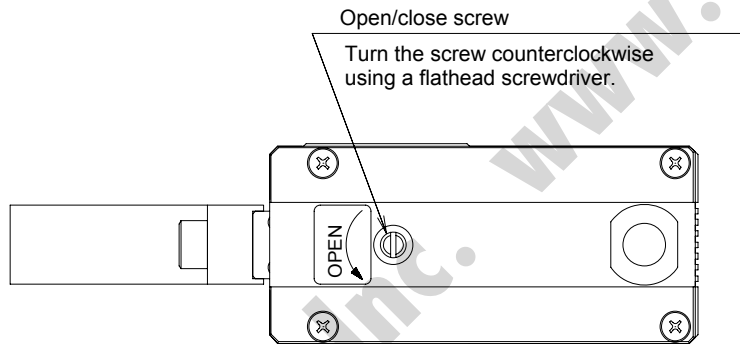

[3-finger type]

Remove one finger attachment and take out the load first, and then turn the open/close screw clockwise.

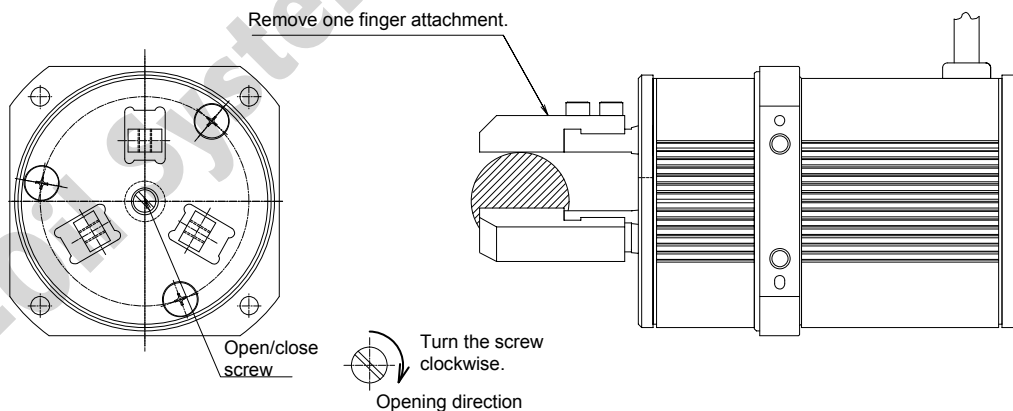

- Abnormal operation results when the servo is turned ON after the power ON.
  - Cause: Excitation phase detection was not performed correctly when the servo was turned ON, because one of the following conditions existed when the power was input:
    - [1] The slider or rod was contacting the mechanical end.
    - [2] The load was being pushed by a strong external force.
  - Action: [1] Check if the slider or rod is contacting the mechanical end.
    - If the slider/rod is contacting the mechanical end, move it away from the mechanical end.
    - If the actuator is equipped with a brake, move the slider/rod after turning ON the brake release switch to forcibly release the brake.
    - At this time, exercise caution not to allow the load to drop suddenly due to its own weight. Your hand may be caught by the dropped load or the robot hand or load itself may be damaged.
    - If the actuator cannot be moved by hand, one possible solution is to check the direction of excited-phase signal detection and change the direction if necessary. If you wish to use this method, consult IAI beforehand.
    - For details, refer to the applicable parameter in 8.2.2, "Parameters Relating to Actuator Operating Characteristics."
  - [2] Check if the load is contacting any surrounding part.
    - If the load is contacting any surrounding part, provide a clearance of 1 mm or more from the applicable part.
    - If the checks in [1] and [2] did not find any problem, please contact IAI.
- The SV lamp blinks.

The automatic servo-off mode is active. (This is not an error or fault.)

## \* Appendix

### List of Supported Actuator Specifications

- Slider, ball screw drive

	Model	Stroke (mm) and maximum speed (mm/sec) (Note 1)																Load capacity (Note 2)		Rated acceleration	
																		Horizontal	Vertical	Horizontal	Vertical
		50	100	150	200	250	300	350	400	450	500	550	600	700	800	900	1000	(kg)	(kg)	(G)	(G)
Motor straight	RCP2-SA6C-I-42P-12-□□□	600																4	1	0.3	0.2
	RCP2-SA6C-I-42P-6-□□□	300																8	2.5	0.3	0.2
	RCP2-SA6C-I-42P-3-□□□	150																8	4.5	0.2	0.2
	RCP2-SA6C-I-42P-12-□□□	600																6	1.5~1	0.3	0.2
	RCP2-SA6C-I-42P-6-□□□	300																12	3~2.5	0.3	0.2
	RCP2-SA6C-I-42P-3-□□□	150																12	6~4	0.2	0.2
	RCP2-SA7C-I-56P-16-□□□	533																35~7	5~0.5	0.3	0.2
	RCP2-SA7C-I-56P-8-□□□	266																40~10	10~1.5	0.3	0.2
	RCP2-SA7C-I-56P-4-□□□	133																40	15~5	0.2	0.2
	RCP2-SS7C-I-56P-12-□□□	600																30~6	4~1	0.3	0.2
	RCP2-SS7C-I-56P-6-□□□	300																30~20	8~2	0.3	0.2
	RCP2-SS7C-I-56P-3-□□□	150																30~20	12~4	0.2	0.2
	RCP2-SS8C-I-56P-20-□□□	666 (600)																40~10	5~0.5	0.3	0.2
	RCP2-SS8C-I-56P-10-□□□	333 (300)																50~4	12~2	0.3	0.2
RCP2-SS8C-I-56P-5-□□□	165 (150)																55~10	20~0.5	0.2	0.2	
Motor reversing	RCP2-SA5R-I-42P-12-□□□	600																4	1	0.3	0.2
	RCP2-SA5R-I-42P-6-□□□	300																8	2.5	0.3	0.2
	RCP2-SA5R-I-42P-3-□□□	150																8	4.5	0.2	0.2
	RCP2-SA6R-I-42P-12-□□□	600																6	1.5~0.5	0.3	0.2
	RCP2-SA6R-I-42P-6-□□□	300																12	3~2	0.3	0.2
	RCP2-SA6R-I-42P-3-□□□	150																12	6~4	0.2	0.2
	RCP2-SA7R-I-56P-16-□□□	533																25~4	5~1	0.3	0.2
	RCP2-SA7R-I-56P-8-□□□	266																35~7	10~1.5	0.3	0.2
	RCP2-SA7R-I-56P-4-□□□	133																35~20	15~3	0.2	0.2
	RCP2-SS7R-I-56P-12-□□□	600 (440)																20~5.5	4~0.5	0.3	0.2
	RCP2-SS7R-I-56P-6-□□□	250																20~2.5	5~0.5	0.3	0.2
	RCP2-SS7R-I-56P-3-□□□	105																30~20	10~1.5	0.2	0.2
	RCP2-SS8R-I-56P-20-□□□	600 (333)																23~1	3~0.5	0.3	0.2
	RCP2-SS8R-I-56P-10-□□□	300 (250)																28~4	9~0.5	0.3	0.2
RCP2-SS8R-I-56P-5-□□□	160 (140)																55~1.5	20~0.5	0.2	0.2	
High-speed	RCP2-HS8C-I-86P-30-□□□	1200 (750)																20~2	3~2	0.3	0.2
	RCP2-HS8R-I-86P-30-□□□	1200 (750)																20~1	3~1	0.3	0.2
Water-proof	RCP2W-SA16C-I-86P-8-□□□	180																2.5~1	-	0.2	-
	RCP2W-SA16C-I-86P-4-□□□	133																3.5~3	-	0.2	-

(Note 1) The figure in the elongated circle indicates the maximum speed for each stroke. The figure in parentheses applies to vertical operation.

(Note 2) The load capacity is based on actuator operation at the rated acceleration.

- Slider, belt drive

	Model	Stroke (mm) and maximum speed (mm/sec)																Load capacity		Rated acceleration	
																		Horizontal	Vertical	Horizontal	Vertical
		500	550	600	650	700	750	800	850	900	950	1000	1050	1100	1150	1200	(kg)	(kg)	(G)	(G)	
	RCP2-BA6-□-PM-54-□□□	1000																4~2	-	0.5	-
	RCP2-BA7-□-PM-54-□□□	1500																8~2	-	0.5	-
	RCP2-BA6U-□-PM-54-□□□	1000																4~2	-	0.5	-
	RCP2-BA7U-□-PM-54-□□□	1500																8~2	-	0.5	-

● Rod type

Model	Stroke (mm) and maximum speed (mm/sec) (Note 1)																Load capacity (Note 2)		Rated acceleration		
																	Horizontal	Vertical	Horizontal	Vertical	
																	(kg)	(kg)	(G)	(G)	
Standard	RCP2-RA2C-I-20P-1-□□□	25																7	2.5	0.05	0.05
	RCP2-RA3C-I-28P-5-□□□	187																15~2	6~1	0.2	0.2
	RCP2-RA3C-I-28P-2.5-□□□	114																30~4	10~2	0.2	0.2
	RCP2-RA4C-I-42P-10-□□□	458 458 350																25~5	4.5~0.5	0.2	0.2
	RCP2-RA4C-I-42P-5-□□□	250 237 175																40~10	12~2	0.2	0.2
	RCP2-RA4C-I-42P-2.5-□□□	125 (114) 118 87																40	19~2.5	0.2	0.2
	RCP2-RA6C-I-56P-16-□□□	450 (400)																40~10	5~1	0.2	0.2
	RCP2-RA6C-I-56P-8-□□□	210																50~30	17.5~1.5	0.2	0.2
	RCP2-RA6C-I-56P-4-□□□	130																55~35	26~1.5	0.2	0.2
Splash-proof	RCP2W-RA4C-I-42P-10-□□□	450 (250) 350																25~5	4.5~2	0.2	0.2
	RCP2W-RA4C-I-42P-5-□□□	190 175																40	12~2.5	0.2	0.2
	RCP2W-RA4C-I-42P-2.5-□□□	125 115 85																40	19~2.5	0.2	0.2
	RCP2W-RA6C-I-56P-16-□□□	320 (265)																40~20	5~1	0.2	0.2
	RCP2W-RA6C-I-56P-8-□□□	200																50	17.5~2	0.2	0.2
	RCP2W-RA6C-I-56P-4-□□□	100																55	26~5	0.2	0.2
Single-guide	RCP2-RGS4C-I-42P-10-□□□	458 350																25~0.5	3.5~0.5	0.2	0.2
	RCP2-RGS4C-I-42P-5-□□□	250 237 175																40~10	11~0.5	0.2	0.2
	RCP2-RGS4C-I-42P-2.5-□□□	125 (114) 118 87																40	18~1.5	0.2	0.2
	RCP2-RGS6C-I-56P-16-□□□	450 (400)																50~30	4~0.5	0.2	0.2
	RCP2-RGS6C-I-56P-8-□□□	210																4~1.5	16~1	0.2	0.2
	RCP2-RGS6C-I-56P-4-□□□	130																55~35	24~0.5	0.2	0.2
Double-guide	RCP2-RGD3C-I-28P-5-□□□	187																15~2	5~0.5	0.2	0.2
	RCP2-RGD3C-I-28P-2.5-□□□	113																30~4	9~1	0.2	0.2
	RCP2-RGD4C-I-42P-10-□□□	458 350																25~5	3.5~0.5	0.2	0.2
	RCP2-RGD4C-I-42P-5-□□□	250 237 175																40~5	11~0.5	0.2	0.2
	RCP2-RGD4C-I-42P-2.5-□□□	125 (114) 118 87																40	18~1.5	0.2	0.2
	RCP2-RGD6C-I-56P-16-□□□	450 (400)																40~10	4~0.5	0.2	0.2
	RCP2-RGD6C-I-56P-8-□□□	210																50~30	16~1	0.2	0.2
	RCP2-RGD6C-I-56P-4-□□□	130																55~35	24~0.5	0.2	0.2
High-thrust	RCP2-RA10C-I-86P-10-□□□	250 (167)																80~15	80~6	0.04	0.04
	RCP2-RA10C-I-86P-5-□□□	125																150	100~3	0.02	0.02
	RCP2-RA10C-I-86P-2.5-□□□	63																300	150~10	0.01	0.01
	RCP2W-RA10C-I-86P-2.6-□□□	250 (167)																80~15	80~6	0.04	0.04
	RCP2W-RA10C-I-86P-2.7-□□□	125																150	100~3	0.02	0.02
	RCP2W-RA10C-I-86P-2.8-□□□	63																300	150~10	0.01	0.01

(Note 1) The figure in the elongated circle indicates the maximum speed for each stroke. The figure in parentheses applies to vertical operation.  
 (Note 2) The load capacity is based on actuator operation at the rated acceleration.

● Gripper

Type	Stroke	Maximum gripping force	Maximum speed	Lead	Rated acceleration	
2-finger	RCP2-GRS-I-PM-1-10-P1	10 mm (5 mm per side)	21N	33.3 mm/s (one side)	1.0 mm	0.3 G
	RCP2-GRM-I-PM-1-14-P1	14 mm (7 mm per side)	80N	36.7 mm/s (one side)	1.1 mm	0.3 G
3-finger	RCP2-GR3SS-I-PM-30-10-P1	10 mm (5 mm per side)	23N	40 mm/s (one side)	2.5 mm	0.2 G
	RCP2-GR3SM-I-PM-30-14-P1	14 mm (7 mm per side)	120N	50 mm/s (one side)	3.0 mm	0.2 G
	RCP2-GR3LS-I-PM-30-19-P1	19 deg	17N	200 deg/sec (one side)	12 deg	0.2 G
	RCP2-GR3LM-I-PM-30-19-P1	19 deg	62N	200 deg/sec (one side)	12 deg	0.2 G

● Rotary

Type	Oscillating angle	Maximum torque	Maximum speed	Gear ratio	Rated acceleration	
Vertical	RCP2-RTB-I-PM-20-330-P1	330 deg	1.1 N-m	600 deg/sec	1/20	0.3 G
	RCP2-RTB-I-PM-30-330-P1	330 deg	1.7 N-m	400 deg/sec	1/30	0.3 G
Flat	RCP2-RTC-I-PM-20-330-P1	330 deg	1.1 N-m	600 deg/sec	1/20	0.3 G
	RCP2-RTC-I-PM-30-330-P1	330 deg	1.7 N-m	400 deg/sec	1/30	0.3 G

- Correlation diagram of speed and load capacity for the slider type (motor-straight type)

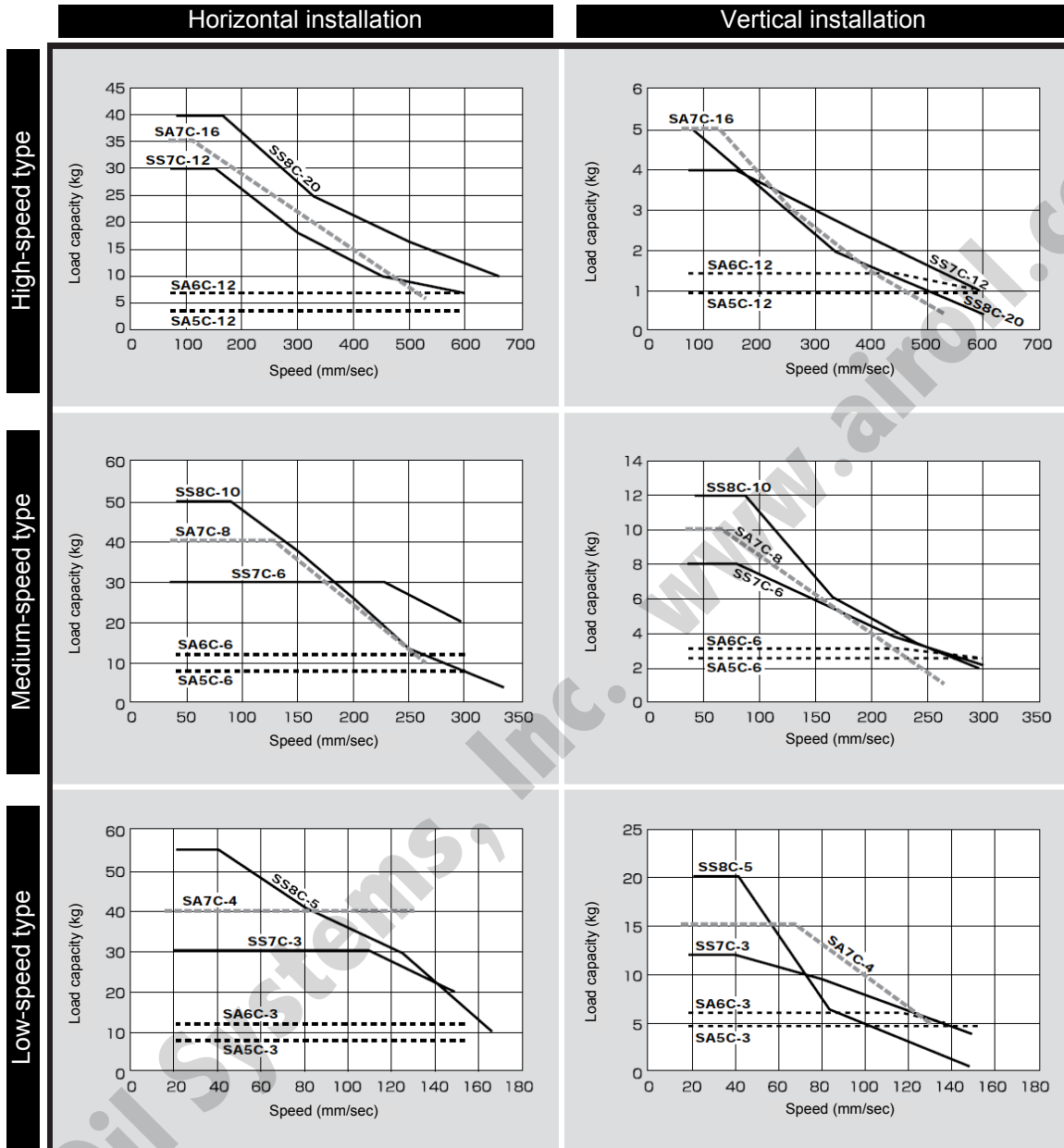

(Note) In the above graphs, the number after the type code indicates the lead.

- Correlation diagram of speed and load capacity for the slider type (motor-reversing type)

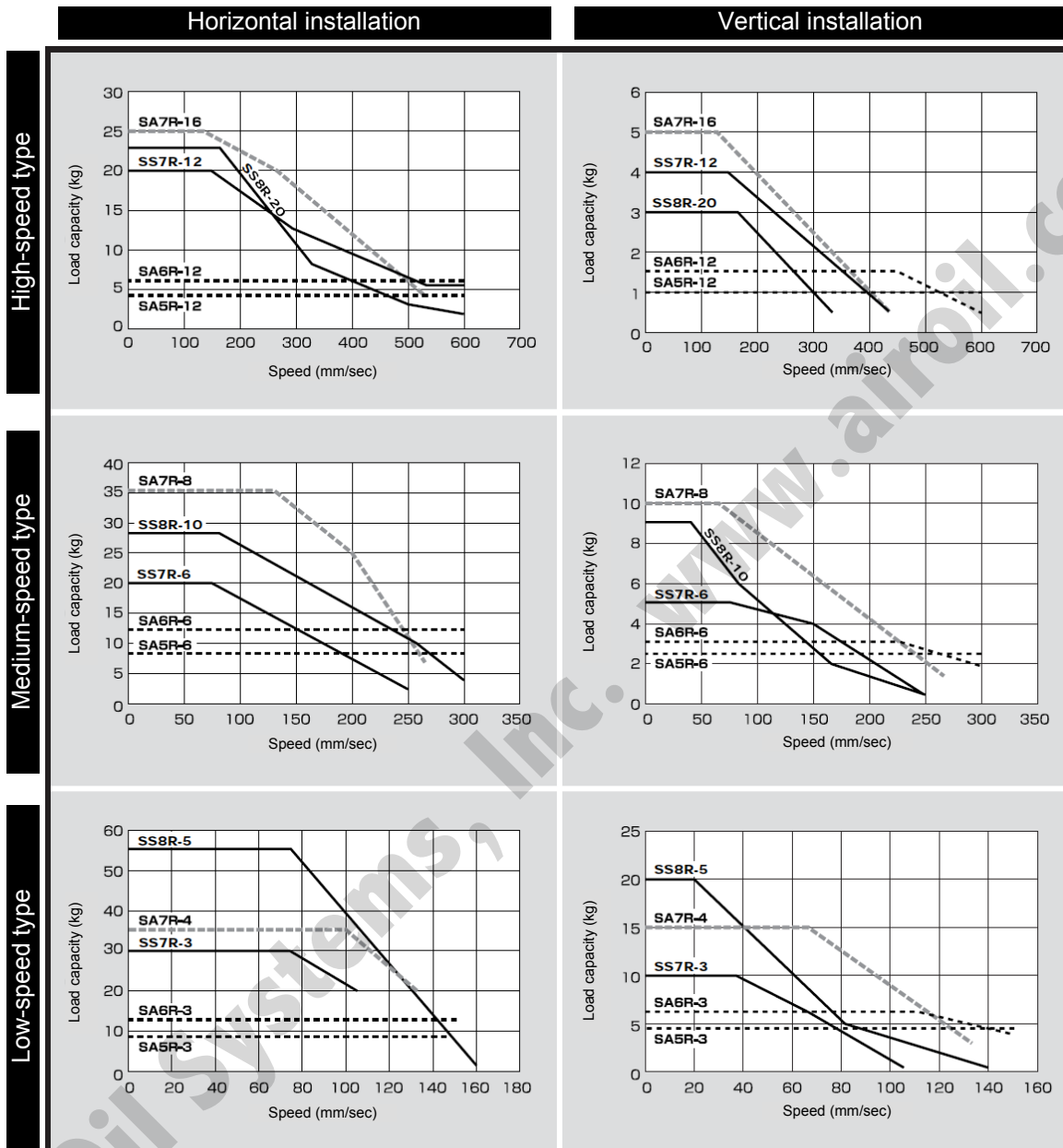

(Note) In the above graphs, the number after the type code indicates the lead.

- Correlation diagram of speed and load capacity for the standard rod type

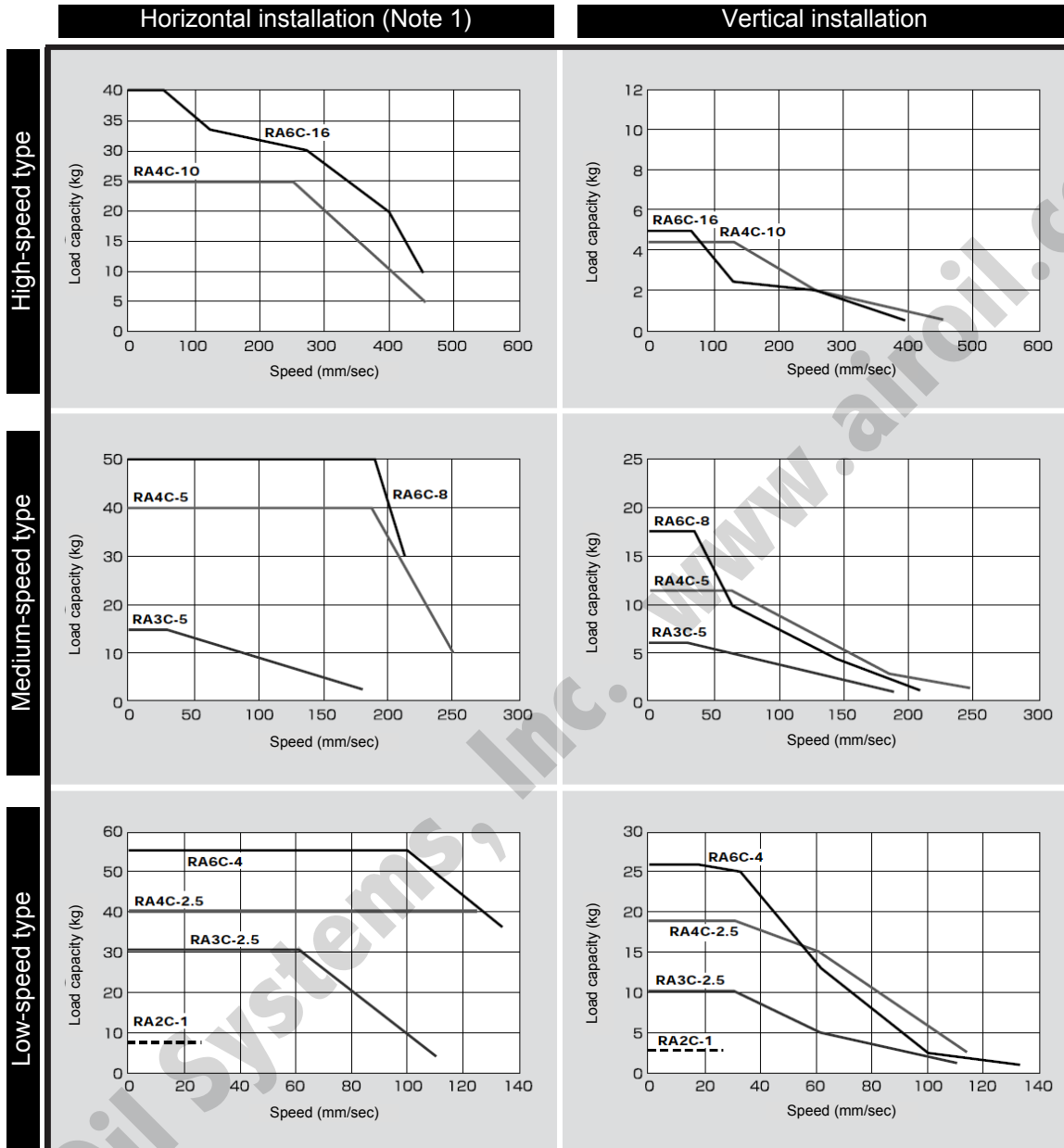

(Note) In the above graphs, the number after the type code indicates the lead.

(Note 1) The figures for horizontal installation assume use of an external guide.

- Correlation diagram of speed and load capacity for the single-guide type

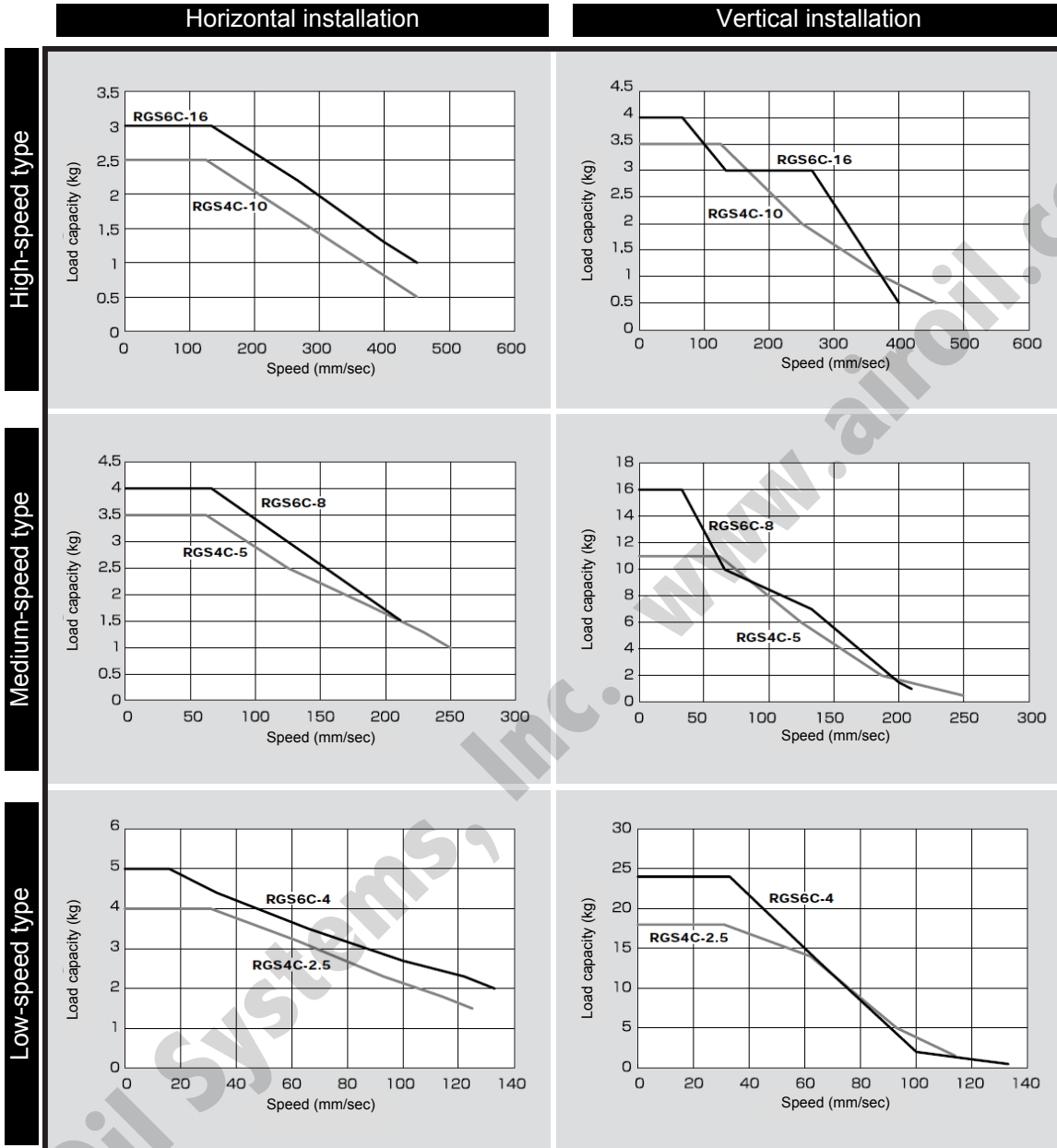

(Note) In the above graphs, the number after the type code indicates the lead.



- Correlation diagram of speed and load capacity for the double-guide type

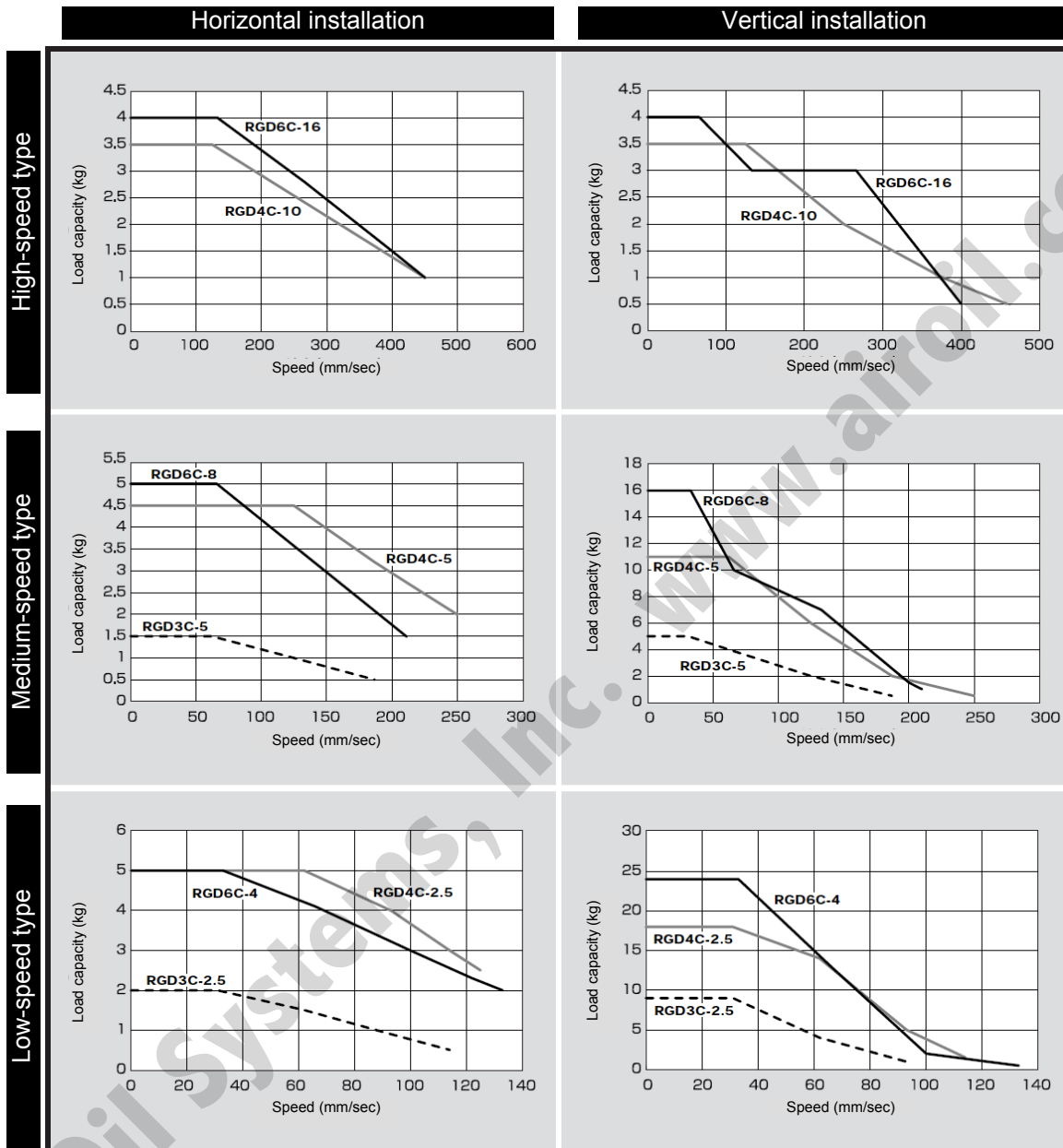

(Note) In the above graphs, the number after the type code indicates the lead.

- Correlation diagram of speed and load capacity for the dustproof/splash-proof type

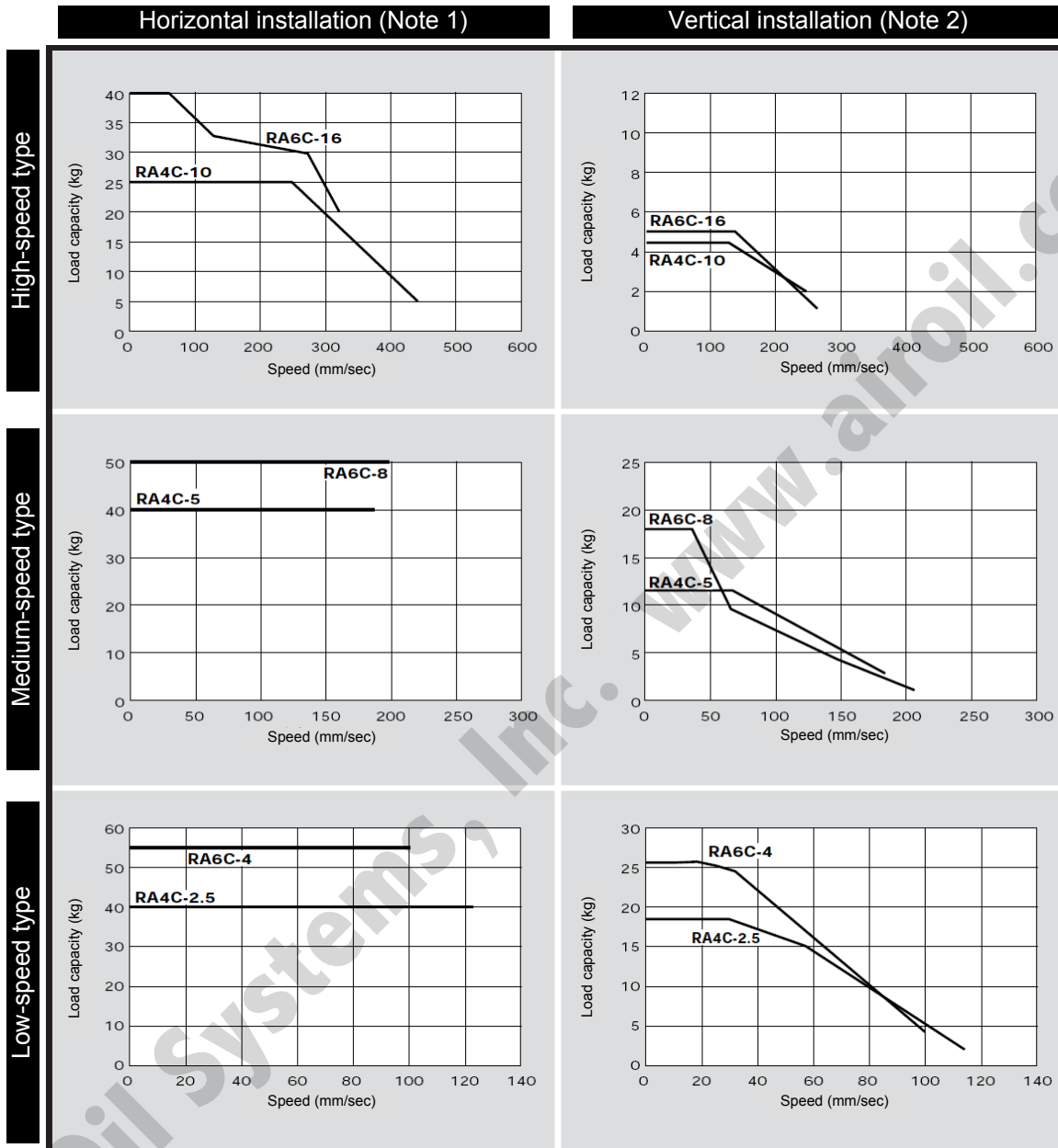

(Note) In the above graphs, the number after the type code indicates the lead.

(Note 1) The figures for horizontal installation assume use of an external guide.

(Note 2) Use of the actuator at the maximum load capacity corresponding to the applicable speed may cause vibration/overshooting. Select an appropriate model that provides an allowance of approx. 70%.

- Correlation diagram of speed and load capacity for the high-thrust type

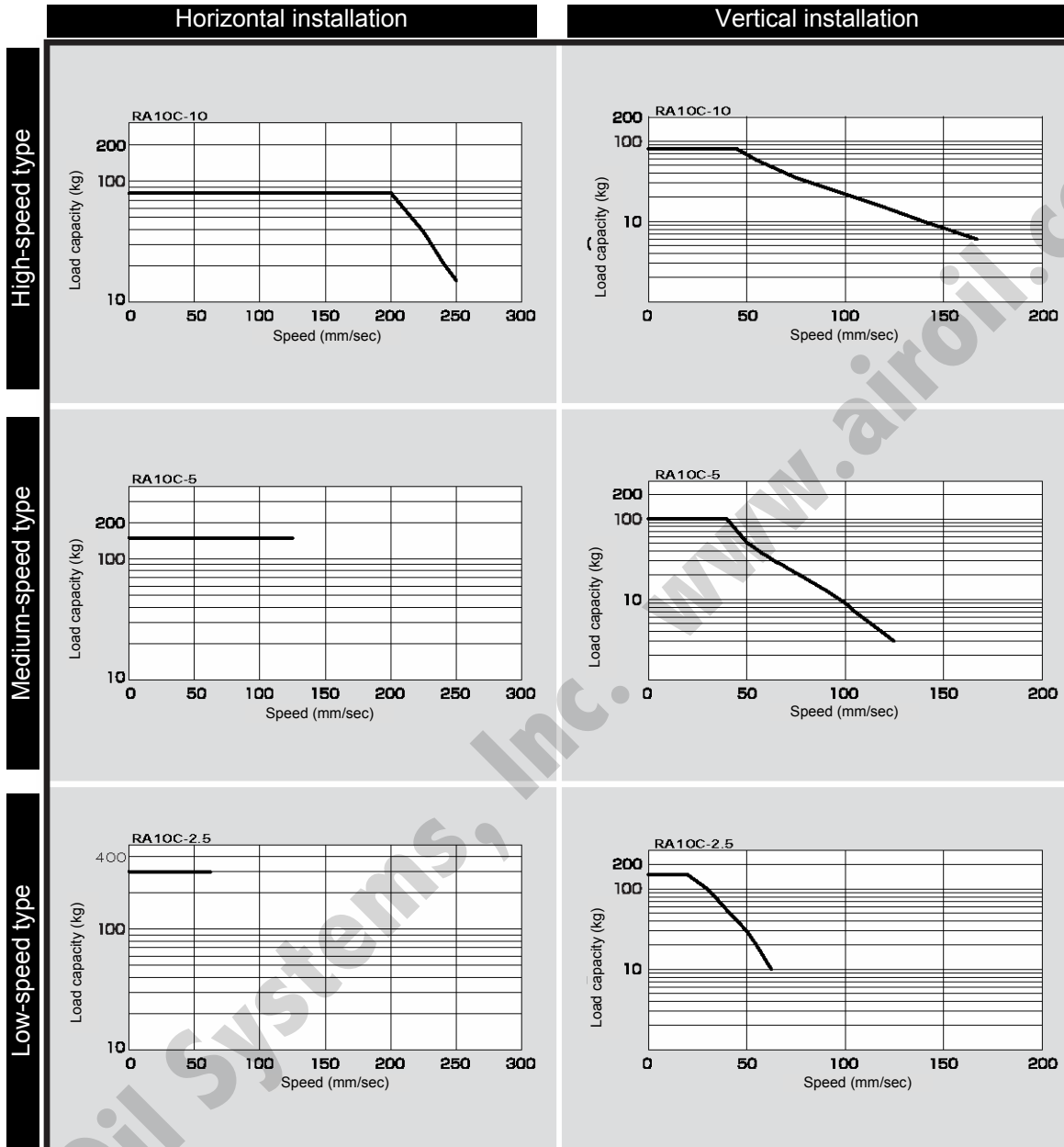

- Fault check and replacement of the cooling fan

A cooling fan is installed in the large-capacity type (PCON-CF).

To check if the fan is faulty, or when replacing the fan, follow the procedure below:

- 1) Unplug all connectors and wires connected to the controller, and take out the controller.

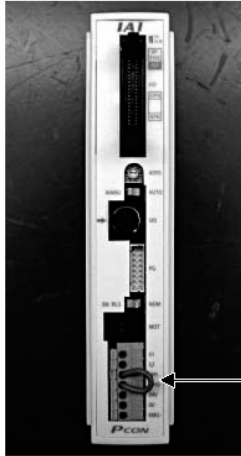

Remove all cables except for the MPI/MPO jumper wire.

- 2) Remove the resin case.

- The cutout holes in the resin case are engaged with the hooks on the mounting base plate. Use a screwdriver, etc., to release the case from each hook, and push the mounting base plate upward.

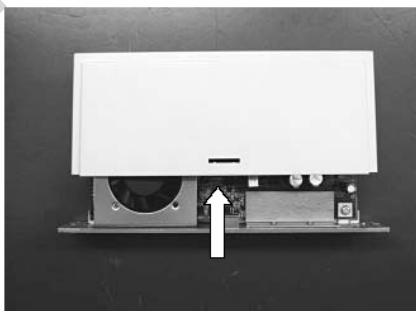
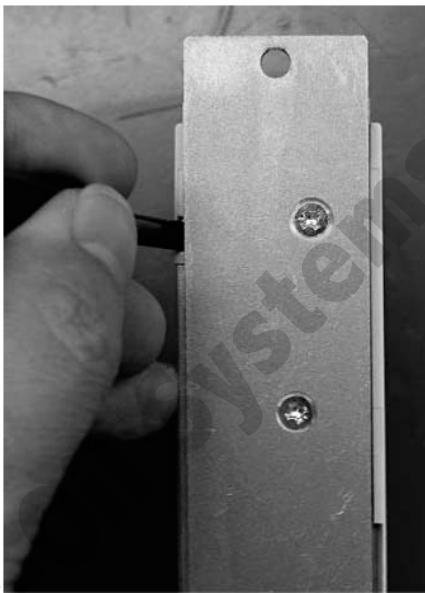

- Pull out the resin case.

- 3) Check if the fan is normal.

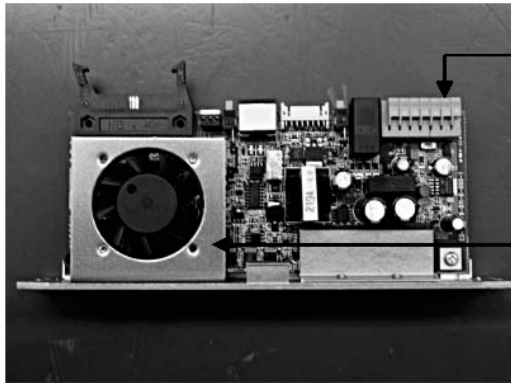

Check method:

[1] Connect the power cable to the 24-V and 0-V terminals on the power-supply terminal block.

[2] Turn on the power to check if the fan operates. If the fan is normal, it should operate for approx. 2 seconds. If the fan is faulty, it will not operate.

(Note) To extend the service life of the fan, a temperature sensor is used to detect the temperature around the power transistor. The fan will operate when the detected temperature reaches 60°C or above, and stop when the temperature drops to 50°C or below. Because of this specification, the fan is designed to operate for approx. 2 seconds when the power is turned on to allow the user to check if the fan is faulty.

- 4) If the fan is faulty, replace it after cutting off the power.

[1] Remove the fan.

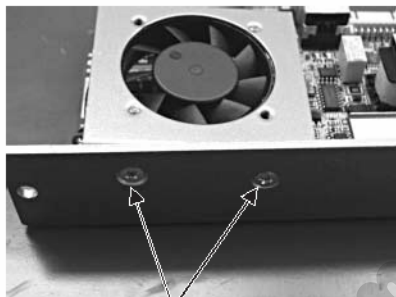

Remove the flat countersunk head screws (M3x5 x 2 pcs).



Remove the pan head screws (M3x12 x 2 pcs).

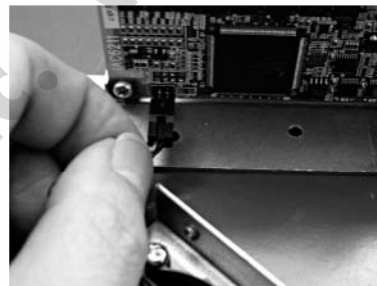

Pull out the connector by hand.



Removed fan and mounting bracket

[2] Install a new fan to the mounting bracket, plug in the connector, and affix the mounting bracket using the flat countersunk head screws.

(Reference) Tightening torque for pan head screws: 61.5 N•cm (6.27 kgf•cm)

[3] To make sure, turn on the power to confirm that the fan operates.

- 5) Turn off the power and pull out the power cable.
- 6) Install the resin case. Engage the cutout holes in the resin case with the hooks on the mounting base plate.
- 7) Plug in the connectors and cables back to their original conditions.

## Example of Basic PCON Positioning Sequence

Given below is an example of basic sequence for creating a positioning sequence using the PCON.

■ indicates PIO signals of the controller.

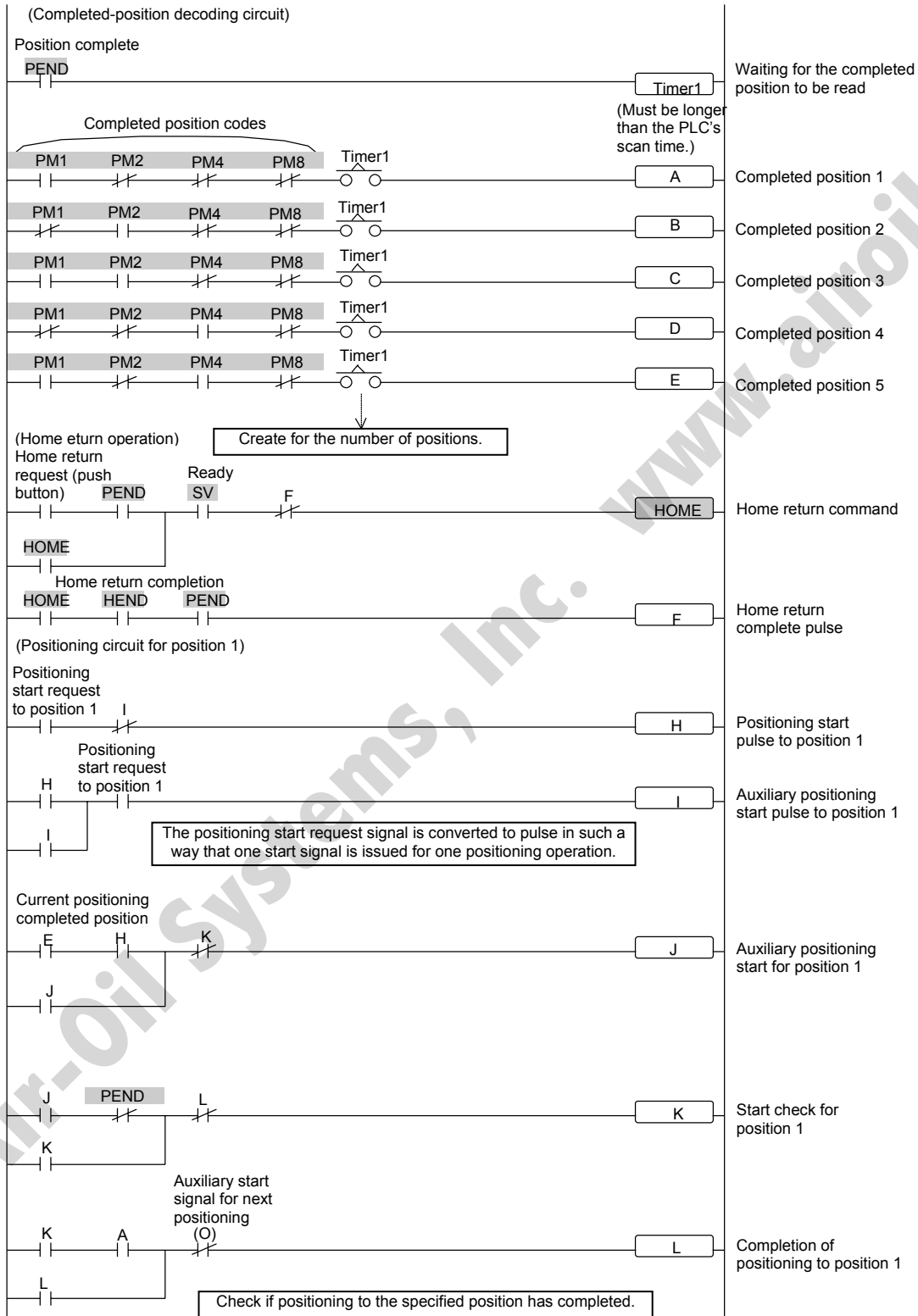

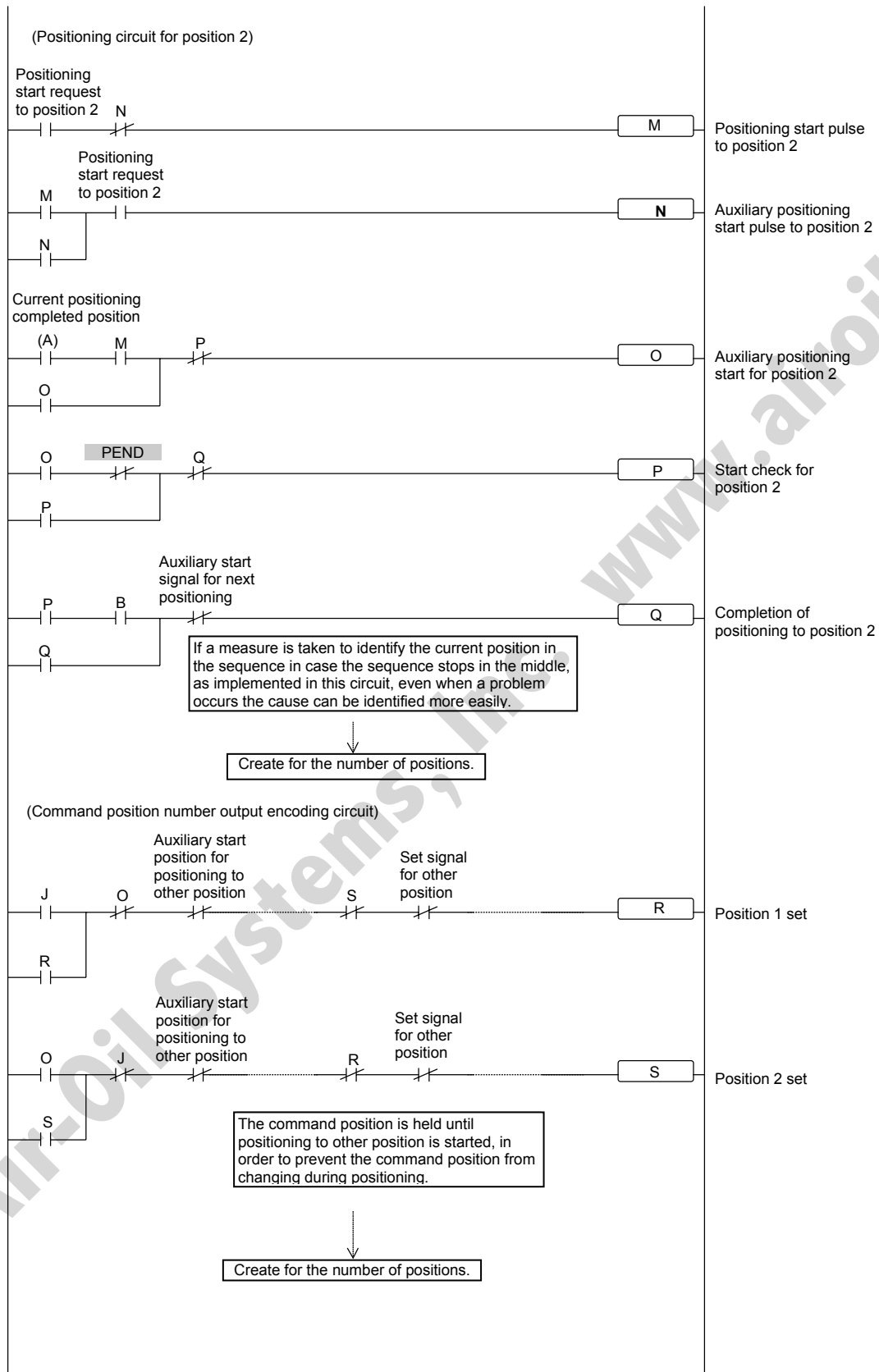

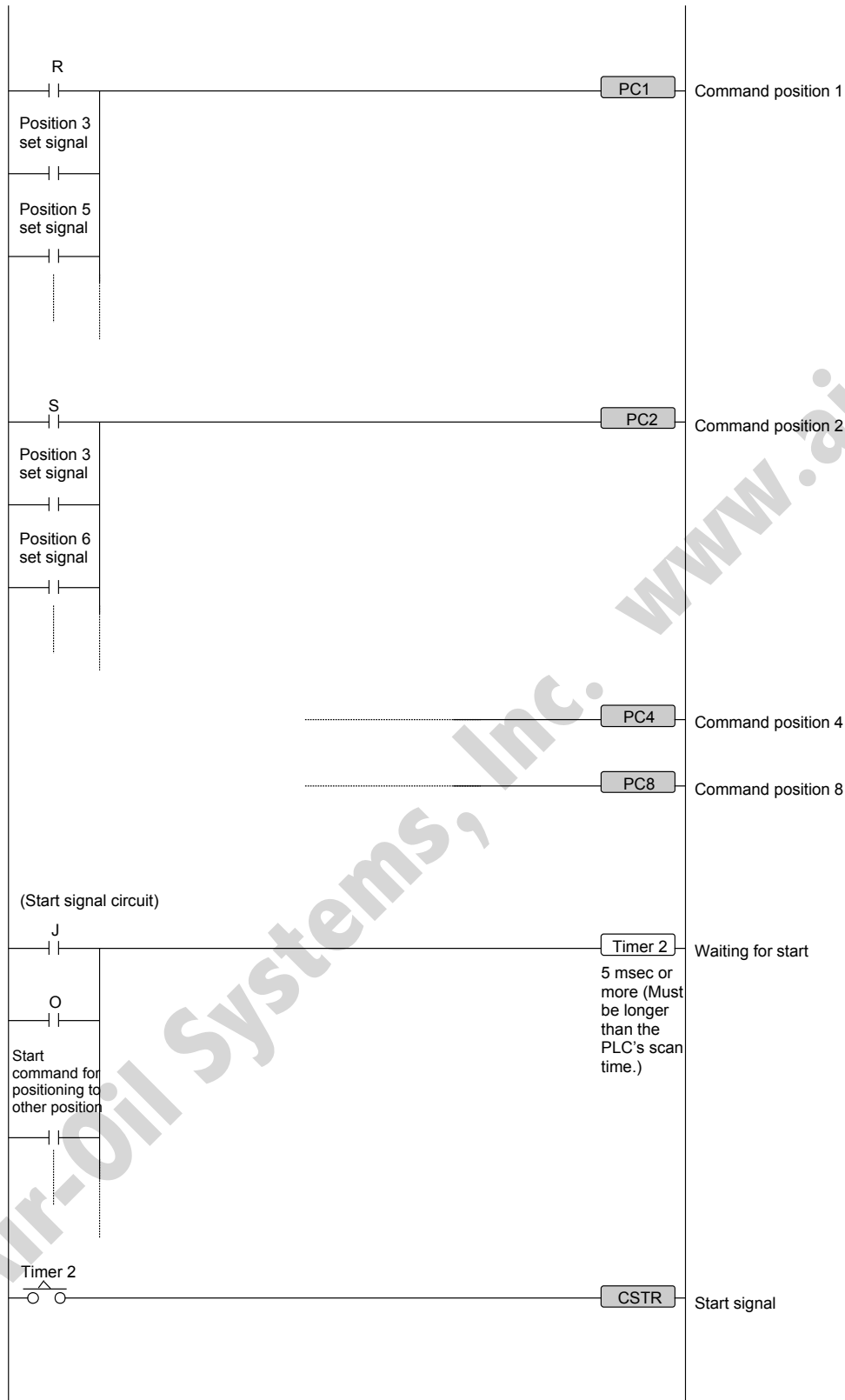



## Recording of Parameters

Recorded date: \_\_\_\_\_

- Category: a: Parameter relating to the actuator stroke range  
 b: Parameter relating to the actuator operating characteristics  
 c: Parameter relating to the external interface  
 d: Servo gain adjustment

No.	Category	Name	Unit	Recorded data
1	a	Zone boundary 1+	mm	
2	a	Zone boundary 1-	mm	
3	a	Soft limit+	mm	
4	a	Soft limit-	mm	
5	a	Home return direction [0: Reverse / 1: Forward]	-	
6	b	Push & hold stop judgment period	msec	
7	d	Servo gain number	-	
8	b	Default speed	mm/sec	
9	b	Default acceleration/deceleration	G	
10	b	Default positioning band (in-position)	mm	
12	b	Current-limiting value at standstill during positioning	%	
13	b	Current-limiting value during home return	%	
16	c	SIO communication speed	bps	
17	c	Minimum delay time for slave transmitter activation	msec	
18	b	Home sensor input polarity	-	
21	c	Servo ON input [0: Enable / 1: Disable]		
22	a	Home return offset	mm	
23	a	Zone boundary 2+	mm	
24	a	Zone boundary 2-	mm	
25	c	PIO pattern selection	-	
26	b	PIO jog speed	mm/sec	
27	c	Movement command type [0: Level / 1: Edge]	-	
28	b	Default direction of excited-phase signal detection [0: Reverse / 1: Forward]		
29	b	Excited-phase signal detection time	msec	
31	d	Speed loop proportional gain	-	
32	d	Speed loop integral gain	-	
33	d	Torque filter time constant	-	
34	b	Push speed	mm/sec	
35	b	Safety speed	mm/sec	
36	b	Automatic servo-off delay time 1	sec	
37	b	Automatic servo-off delay time 2	sec	
38	b	Automatic servo-off delay time 3	sec	
39	c	Output mode of position complete signal [0: PEND / 1: INP]	-	
40	c	Home-return input disable selection [0: Enable / 1: Disable]		

No.	Category	Name	Unit	Recorded data
41	c	Operating-mode input disable selection [0: Enable / 1: Disable]	-	
42	b	Enable function [0: Enable / 1: Disable]	-	
43	b	Polarity of home check sensor input [0: Contact a / 1: Contact b]	-	
45	c	Silent interval multiplier	-	
46	b	Speed override	%	
47	b	PIO jog speed	mm/sec	
48	b	PIO inching distance	mm	
49	b	PIO inching distance 2	mm	
50	b	Load output judgment time	msec	
51	b	Torque check range [0: Enable / 1: Disable]	-	
77	b	Ball screw lead length	mm	
78	b	Axis operation type	-	
79	b	Rotational axis mode selection	-	
80	b	Shortcut selection for rotation	-	
86	b	Absolute unit [0: Not used / 1: Used]	-	

Air-Oil Systems, Inc. [www.airoil.com](http://www.airoil.com)

Air-Oil Systems, Inc. [www.airoil.com](http://www.airoil.com)



## ***IAI America, Inc.***

Head Office: 2690 W. 237th Street, Torrance, CA 90505  
TEL (310) 891-6015 FAX (310) 891-0815

Chicago Office: 1261 Hamilton Parkway, Itasca, IL 60143  
TEL (630) 467-9900 FAX (630) 467-9912

New Jersey Office: 7 South Main St., Suite-F, Marlboro, NJ 07746  
TEL (732) 683-9101 FAX (732) 683-9103

Website: [www.intelligentactuator.com](http://www.intelligentactuator.com)

## ***IAI Industrieroboter GmbH***

Ober der Röth 4, D-65824 Schwalbach am Taunus, Germany  
TEL 06196-88950 FAX 06196-889524