

actuators

**AR** Series  
Rotary Actuator

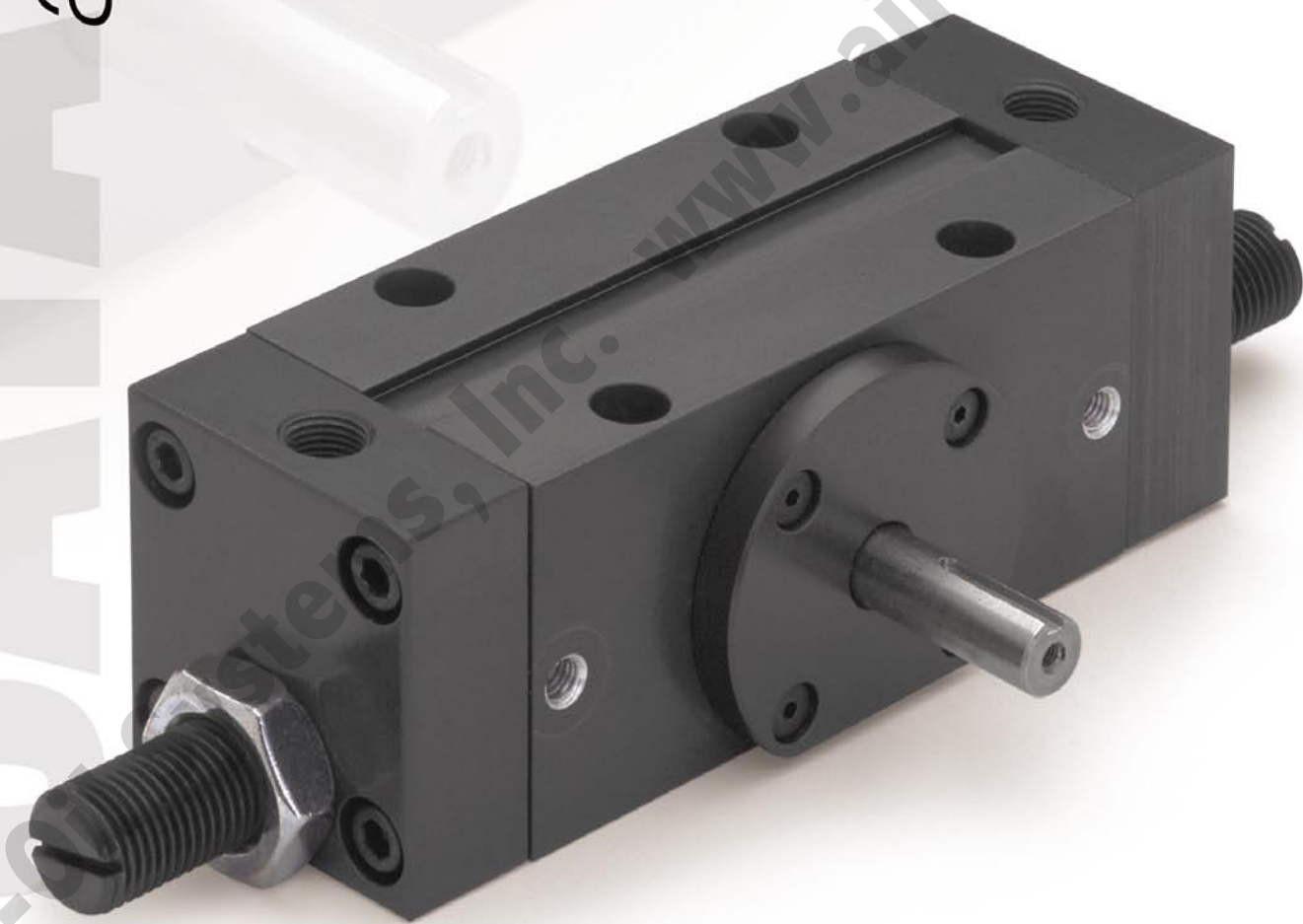

**numatics**

# Table of Contents

**NUMATICS®**

<b>AR Series</b> .....	3-8
Features and Benefits .....	3
How to Order .....	4
Dimensions .....	5
Technical Specifications .....	6
<i>NuMate</i> ™ Compatibility .....	6
Switch Information .....	7-8

Air-Oil Systems, Inc. [www.airoil.com](http://www.airoil.com)



### Rotary Actuator Utilizes a Dual Rack-n-Pinion System

The Torque Rack produces the Rotary output Torque while the control Rack determines Rotary stroke.

The output shaft is supported by two angular contact Bearings. The *NuMate*™ mounting feature provides a convenient method of mounting the AR-Rotaries to the SH-Series linear slide.

#### A. Body:

Hardcoat Anodized Aluminum ..... Lightweight, durable,  
High strength to weight ratio, Teflon® impregnated inside and out

Multiple mounting surfaces ..... Flexible, easy access mounting

#### B. Output Shaft:

Hardened electroless nickel ..... Corrosion and wear resistance

Angular Contact Bearings      Two angular contact bearings better supporting  
both thrust and Radial loads.

#### C. Stroke Adjustment:

C.W. and C.C.W. Adjustment over 185° total stroke .....  
Infinite adjustment in both directions of rotation, secured by jam nut

#### D. Sensor Mounting Channel:

Machined into body ..... Accepts Numatics Motion Control  
dovetail switches (world switch), Easy access, easy adjustment

Magnetic piston is standard on all models.

Permanently lubricated seals are standard on all models, no lube required.  
Viton compound for high temperature applications, optional.

Factory lubricated, fluorinated grease. Non-toxic, non-migrating and no chlorine, silicones or chlorofluorocarbons (CFCs). Cleanroom applied.

#### Additional options:

- Shock absorbers
- Double output shaft

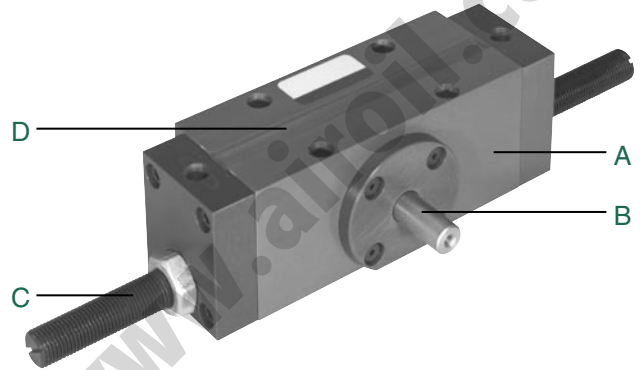

Air-Oil Systems, Inc. www.air-oil.com



## AR Series

### How to Order

AR 020 A 1 A Z C 1 X

#### Bore Sizes

020 = 20 mm  
025 = 25 mm  
032 = 32 mm

#### Rotation

A = 90°-180°

#### Seal Option

1 = Buna  
2 = Viton

#### Shaft Option

A = Standard Single Shaft End  
Z = Additional Double Shaft End\*  
\*Tapped both ends.

#### Disk Size\*\*

A = ND020  
B = ND025  
C = ND032  
X = No Disk.

#### Shock Options

1 = Shocks Yes  
2 = Shocks No

#### Sensing Position

A = Single Position CW  
B = Single Position CCW  
C = Two Position  
D = No Sensing

#### Sensing Type

Standard Cord Set  
1 = Hall Effect - PNP (sourcing)  
2 = Hall Effect - NPN (sinking)  
3 = Reed Switch  
6 = No Sensing  
Quick Disconnect Cord Set  
Z = Hall Effect - PNP (sourcing)  
Y = Hall Effect - NPN (sinking)  
X = Reed Switch  
See page 7.

Example order:

Part Number: AR020A1AZC1X\*

Part Description: AR rotary with 20mm bore, 90° rotation, standard seals, standard single output shaft, Hall PNP quick disconnect sensing, two positions, with shocks without *NuMate™* disk.

\*When entering an order, DO NOT use spaces or dashes. Follow example above.

### Replacement Components and Kits

#### AR Rotary Seal Kit

SERIES	BUNA	VITON	REPLACEMENT	SHOCKS
AR020	ARSKB-020	ARSKV-020	AR020	SK030
AR025	ARSKB-025	ARSKV-025	AR025	SK106
AR032	ARSKB-032	ARSKV-032	AR032	SK106

#### Sensing Kits

##### STANDARD CORD SET

SWITCH	PART NO.
Hall Effect PNP (Sourcing)	HPNPS31
Hall Effect NPN (Sinking)	HNPNS32
Reed Switch	RSS02

##### QUICK DISCONNECT CORD SET

SWITCH	PART NO.
Hall Effect PNP (Sourcing)	HPNPQ31
Hall Effect NPN (Sinking)	HNPNQ32
Reed Switch	RSQ02
90° 5 meter cable	PXC90
Straight 5 meter cable	PXCST

### *NuMate™* Disk

The *NuMate™* Disk provides a simple solution for combining Rotary and Linear motion

#### \*\*Compatibility Table

AR Series	SH Series	ND
AR020	SH056	ND020
AR025	SH075	ND025
AR032	SH106	ND032

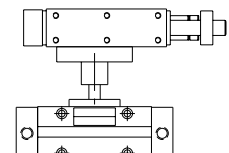
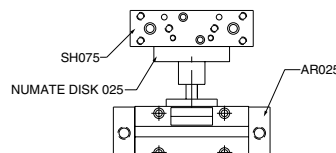
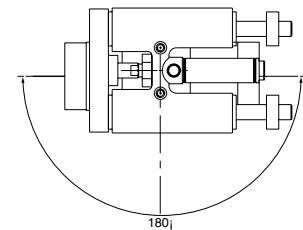
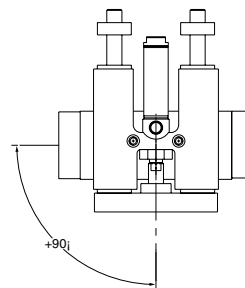



### AR Series

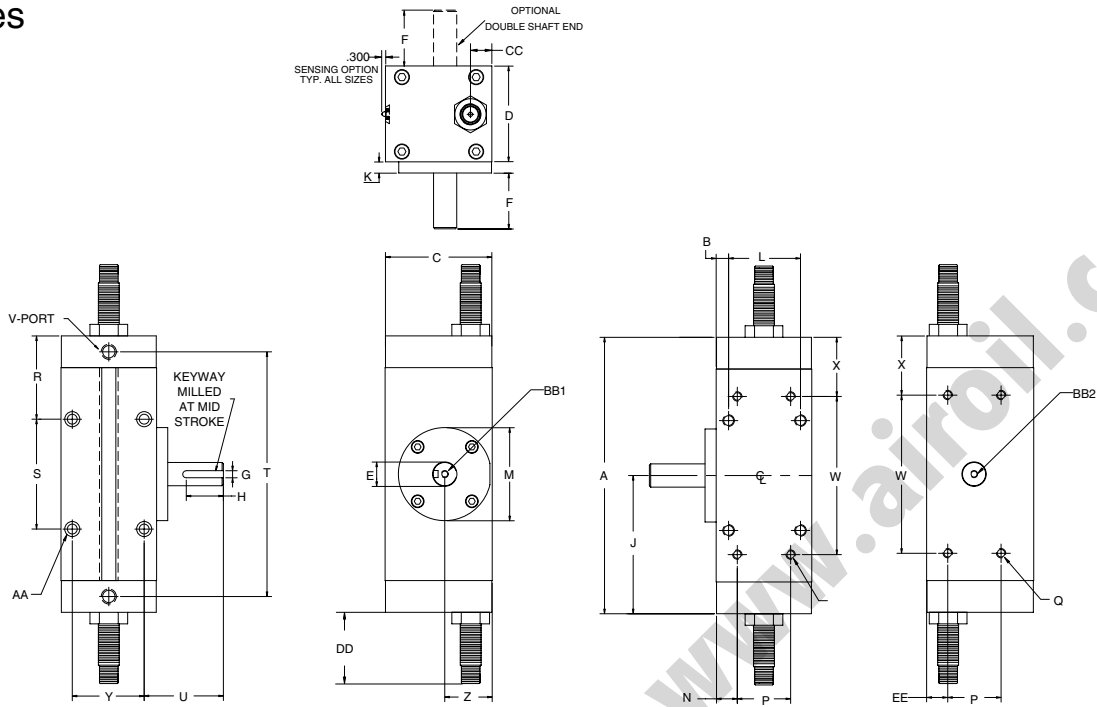

	AR020	AR025	AR032
A	5.18	6.43	7.43
B	0.22	0.22	0.33
C	1.83	2.25	2.89
D	1.76	2.12	2.56
E	0.37	0.47	0.63
F	1.00	1.28	1.50
G	0.093 X 0.054/0.058 DP	0.125 X 0.070/0.074 DP	0.187 X 0.105/0.110 DP
H	0.65	0.75	1.00
J	2.58	3.21	3.71
K	0.24	0.25	0.30
L	1.31	1.57	1.94
M	1.87	2.125	2.50
N	0.47	0.49	0.56
P	0.81	1.13	1.44
Q	10-32	1/4-20	1/4-20
R	1.50	2.02	2.23
S	2.16	2.37	2.96
T	4.46	5.71	6.57
U	1.46	1.75	2.13
V	1/8 NPT	1/8 NPT	1/8 NPT
W	3.38	3.81	4.26
X	0.90	1.30	1.58
Y	1.31	1.57	1.94
Z	0.80	0.98	1.27
AA	C' Bored for M4 SHCS, Tapped M5 X 0.8 from opposite side	C' Bored for M5 SHCS, Tapped M8 X 1.25 from opposite side	C' Bored for M6 SHCS, Tapped M8 X 1.25 from opposite side
BB1	M3 X 0.5	M5 X 0.8	M5 X 0.8
BB2	M3 X 0.5	M5 X 0.8	M5 X 0.8
CC	0.40	0.51	0.58
DD	1.31	1.50	1.81
EE	0.40	0.42	0.56



## AR Series

### AR Series

MODEL	TORQUE @ 100PSI	DYNAMIC THRUST LOAD	DYNAMIC RADIAL LOAD	DISPLACEMENT PER DEGREE	UNIT WEIGHT	MAXIMUM PRESSURE
AR020	14.6 inlb (1.6 N-m)	106 lbf (471 N)	421 lbf (1872 N)	0.0026 cuin. (0.043 cc)	2.3 lbs	250 psi
AR025	29.4 inlb (3.3 N-m)	127 lbf (564 N)	501 lbf (2228 N)	0.0052 cuin. (0.085 cc)	3.1 lbs	250 psi
AR032	61.3 inlb (6.9 N-m)	191 lbf (849 N)	677 lbf (3011 N)	0.0108 cuin. (0.177 cc)	5.7 lbs	250 psi

### Shock Option

### Face Mounting

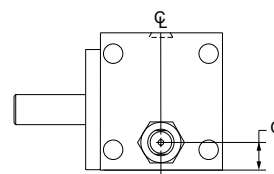
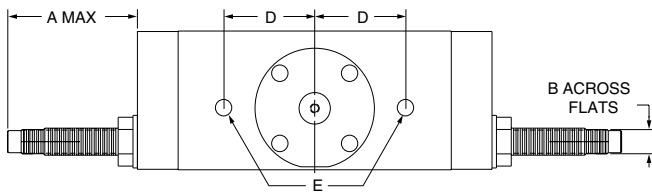

	AR020	AR025	AR032
A	2.70	2.70	2.75
B	0.49	0.49	0.49
C	0.40	0.51	0.58
D	1.69	1.90	2.12
E	M5	M6	M8

### Kinetic Energy Basic Formula

$$KE = 1/2 J \omega^2$$

$$\omega = 0.035 \times \frac{\text{Angle traveled (deg.)}}{\text{Rotation time (sec)}}$$

KE = Kinetic Energy

J = Rotational mass moment of inertia (in-lb-sec<sup>2</sup>)

(dependent on physical size of object and weight)

W = Peak Velocity (rad/sec) (Assuming twice average velocity)

W = Weight of load (lb)

g = Gravitational constant = 386.4 in/sec<sup>2</sup>

r = Radius of gyration (in)

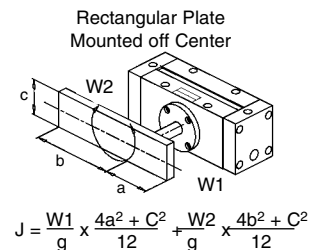
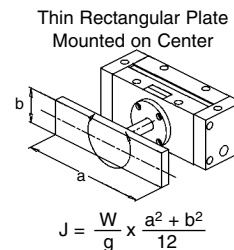
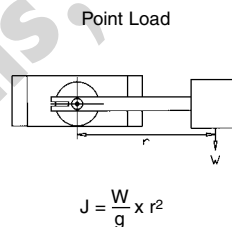
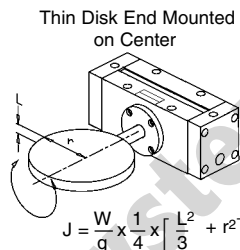
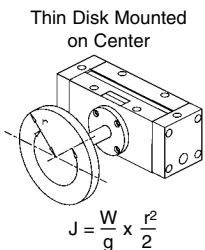

### NuMate™ Direct Mount, Mounting System

The NuMate™ mounting system provides a standard series of drilled, tapped and counterbored holes allowing each slide series to mount with each other and other slide series in various combinations without the use of adapter, transition plates or other costly methods. The NuMate™ mounting system is the most versatile mounting method of its kind, providing customers with a cost effective method of building modular component automation. The NuMate™ mounting system is consistent across the Numatics Motion Control spectrum of products for automation.

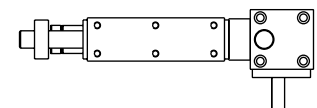
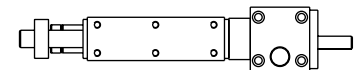
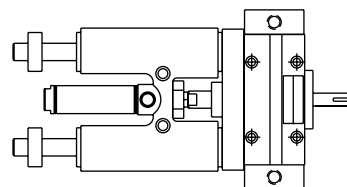

### Compatibility Table

SH SERIES	AR SERIES
SH075	AR020
SH106	AR025
SH150	AR032



### AR Series Switch Information

	SWITCH OR BRACKET DESCRIPTION	STANDARD PART NO.	QUICK DISCONNECT PART NO.
1	Hall Effect - PNP (Sourcing)	HPNPS31	HPNPQ31
1	Hall Effect -NPN (Sinking)	HNPNS32	HNPNQ32
1	Reed Switch	RSS02	RSQ02
2	Dovetail Bracket	DSA	DSA

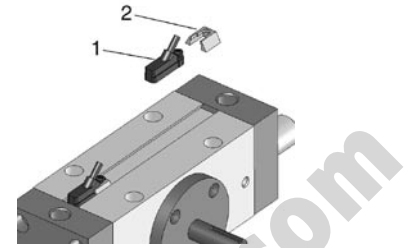

#### RSS02 – Reed Switch (AC/DC NO), flying lead

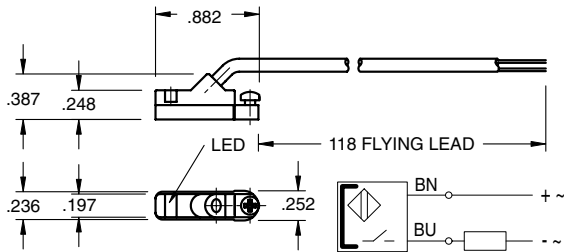

##### Sensing Data

Ambient temperature range $T_a$	(°F/°C)	-4 to 176 (-20 to 80)
Frequency of operating cycles $f$ at $U_e$	(kHz)	0.5
Turn on time $t$	(ms)	$\leq 0.25$
turn off time $t$	(ms)	0.03
LED function indication		yes

##### Electrical Data

Rated operational voltage $U_e$	(V)	3...130 AC/DC
Supply voltage $U_B$	(V)	3...130 AC/DC
Voltage drop $U_d$ at $I_e$ Stat./dyn.	(V)	3.5
Rated insulation voltage $U_i$	(V)	2750 DC (EN 60335-1)
Rated supply frequency	(Hz)	AC/DC
Rated operational current $I_e$	(mA)	50 (10W max.)
No-load supply current $I_o$ at $U_e$ d./und.	(mA)	0
Observe polarity for correct LED function		

#### RSQ02 – 8mm connector

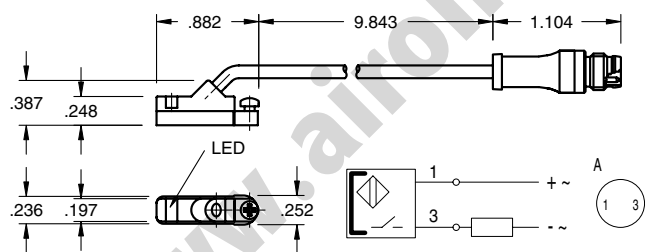

##### Mechanical Data

Housing material	Polyamide
Material of sensing face	Polyamide
Connection	PVC cable
Degree of Protection	IP 67
Rated shock: half-sinus, 50g, 11 ms	
Rated vibration environment: 10g, 10...2000 Hz, 90 min	



#### HPNPS31 – Electronic Switch (PNP NO), flying lead

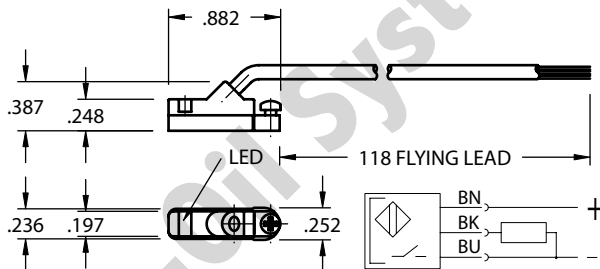

##### Sensing Data

Ambient temperature range $T_a$	(°F/°C)	-13 to +158 (-25 to +70)
Temperature drift	(% of )	$\leq 0.3\%/^{\circ}\text{C}$
Frequency of operating cycles $f$ at $U_e$	(kHz)	10
Turn on time $t$	(ms)	.05
turn off time $t$	(ms)	.05
Utilization categories		DC13
Function-supply voltage indication		YES

##### Electrical Data

Rated operational voltage $U_e$	(V)	24 DC
Supply voltage $U_B$	(V)	10...30 DC
incl. ripple	(% of $U_e$ )	15
Voltage drop $U_d$ at $I_e$ Stat./dyn.	(V)	1/-
Rated insulation voltage $U_i$	(V)	75 AC
Rated supply frequency	(Hz)	DC
Rated operational current $I_e$	(mA)	200
No-load supply current $I_o$ at $U_e$ d./und.	(mA)	25/13
Protected against polarity reversal		YES



#### HPNPQ31 – 8mm connector

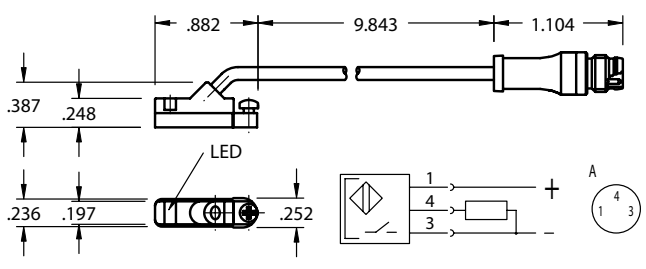

##### Mechanical Data

Housing material	Polyamide
Material of sensing face	Polyamide
Connection	PVC cable
Degree of Protection	IP 67
Rated shock: half-sinus, 30 g, 11 ms	
Rated vibration environment: 55 Hz, 1mm amplitude, 3 x 30	



## AR Series

### HNPNS32 – Electronic Switch (NPN NO), flying lead

### HNPNQ32 – 8mm connector

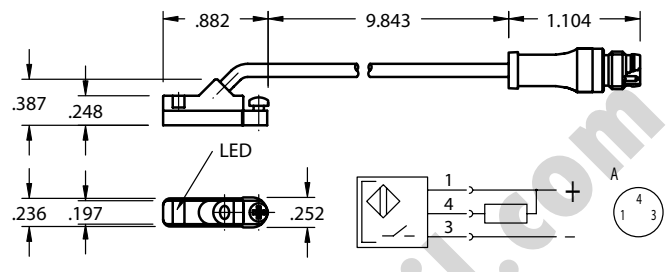
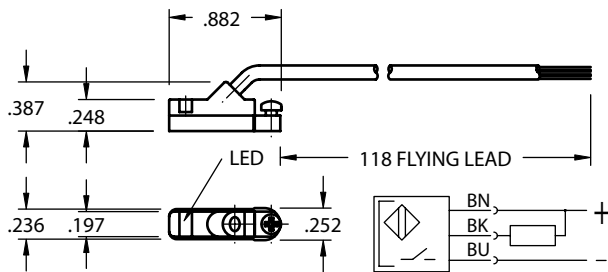

#### Sensing Data

Ambient temperature range $t_d$	(°F/°C)	-13 to +158 (-25 to +70)
Temperature drift	(% of $S_r$ )	$\leq 0.3\%/^{\circ}\text{C}$
Frequency of operating cycles $f$ at $U_e$	(kHz)	10
Turn on time $t$	(ms)	.05
Turn off time $t$	(ms)	.05
Utilization categories		DC13
Function-supply voltage indication		YES

#### Electrical Data

Rated operational voltage $U_e$	(V)	24 DC
Supply voltage $U_B$	(V)	10...30 DC
incl. ripple	(% of $U_e$ )	15
Voltage drop $U_d$ at $I_e$ Stat./dyn.	(V)	1/-
Rated insulation voltage $U_i$	(V)	75 AC
Rated supply frequency	(Hz)	DC
Rated operational current $I_e$	(mA)	200
No-load supply current $I_o$ at $U_e$ d./und.	(mA)	25/13
Protected against polarity reversal		YES

#### Mechanical Data

Housing material	Polyamide
Material of sensing face	Polyamide
Connection	PVC cable
Degree of Protection	IP 67
Rated shock: half-sinus, 30 g, 11 ms	
Rated vibration environment: 55 Hz, 1mm amplitude, 3 x 30	



## Female Connectors for Reed Switches and Hall Effect Sensors

Dimensions (mm)

TYPE	ORDER CODE
Straight, 5 m Cable	PXCST
Elbow, 5 m Calbe	PXC90

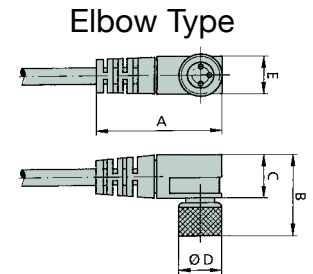
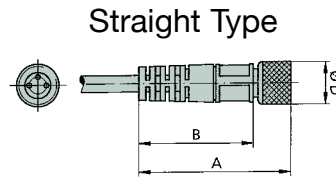



# NUMATICS®

World Class Supplier  
of Pneumatic Components



## World Headquarters

### Numatics Incorporated

Phone: 248-887-4111  
Fax: 248-887-9190

## UNITED STATES

### Numatics – Air Preparation

Phone: 810-667-3900  
Fax: 810-667-3902

### Numatics – Valves

Phone: 248-887-4111  
Fax: 248-887-9190

### Numatics – Miniature Valves

Phone: 248-960-1400  
Fax: 248-960-2160

### Numatics – Cylinders

Phone: 615-771-1200  
Fax: 615-771-1201

### Numatics – Rodless Cylinders

Phone: 519-452-1777  
Fax: 519-452-3995

### Numatics – Automation

Phone: 440-934-3200  
Fax: 440-934-2288

## CANADA

### Ontario

Numatics, Ltd.  
Phone: 519-452-1777  
Fax: 519-452-3995

### Quebec

Numatics, Ltd.  
Phone: 514-332-6444  
Fax: 514-332-9273

### British Columbia

Numatics, Ltd.  
Phone: 604-574-0401  
Fax: 604-574-3713

## EUROPE

### Germany – European Headquarters

Numatics GmbH  
Phone: 011-49-22 41-31 60-0  
Fax: 011-49-22 41-31 60 40

### Hungary

Numatics Kft.  
Phone: 011-36-13 82 21 35  
Fax: 011-36-12 04 39 47

## EUROPE

### England

Numatics Limited  
Phone: 011-44-1525-37 07 35  
Fax: 011-44-1525-38 25 67

### France

Numatics s.a.r.l.  
Phone: 011-33-1 41 21 48 88  
Fax: 011-33-1 41 21 48 89

### Italy

Numatics srl  
Phone: 011-39-030-373 19 99  
Fax: 011-39-030-373 19 81

### Netherlands

Numatics B.V.  
Phone: 011-31-418-65 29 50  
Fax: 011-31-418-65 29 43

### Spain

Numatics Spain S.L.  
Phone: 011-34-93-221 21 96  
Fax: 011-34-93-221 35 14

## AFRICA

### South Africa

Numatics SA (Pty) Ltd.  
Phone: 011-27-11-8 65 44 52  
Fax: 011-27-11-8 65 42 90

## LATIN & SOUTH AMERICA

### Mexico

Numatics de Mexico S.A. de C.V.  
Phone: 011-52-222-284 6176  
Fax: 011-52-222-284 6179

### Brazil

Valvair Comercial Ltda.  
Phone: 011-55-12-351 2874  
Fax: 011-55-12-351 1958

## ASIA & PACIFIC

### Australia

Numatics Australia Pty. Ltd.  
Phone: 011-61-3-95 63 86 00  
Fax: 011-61-3-95 63 85 11

### Taiwan – Asian Headquarters

Numatics Co, Ltd. Asia  
Phone: 011-886-2-29 15 16 05  
Fax: 011-886-2-29 14 18 97

For a comprehensive listing of all Numatics production and distribution facilities worldwide, visit [www.numatics.com](http://www.numatics.com)